

The wedi world of systems

Integrated solutions for modular bathroom concepts





Product highlight:
wedi Top Line

Building systems

wedi headquarters

Telephone + 49 2572 156-0
E-Mail info@wedi.de

Sales enquiries

Fax + 49 2572 156-133
E-Mail sales@wedi.de

SPA & wellness enquiries

Telephone + 49 2572 156-0
Fax + 49 2572 156-239
E-Mail project@wedi.de

Technical enquiries

Telephone + 49 2572 156-0
Fax + 49 2572 156-133
E-Mail TechSystem@wedi.de



The wedi principle of customised design

The modular wedi system opens up a multitude of possibilities so that every bathroom and wet room can be individually designed. Whether it's a new build or a renovation, wedi offers perfectly coordinated products which can be combined with one another any way you like for every initial situation in the bathroom – from the wedi Fundo shower systems and building systems through design elements and ready-to-install design surfaces to a wide range of system accessories.

Quick reference of contents



01 wedi bathroom systems

System structures.....	10
WC solution, shower situation, bench and tray elements	
System structures.....	12
bath cladding, shower situation	
System structures.....	14
Technical wall, hot water heating system, floor construction	

02 wedi Fundo® shower systems

wedi Shower Configurator....	17
Point shower systems.....	20
Point drainage system configuration	
Shower elements	
Substructure element and sloping boards	
Drain systems	
Drain grids incl. frames	
Linear shower systems	30
Linear drainage system configuration	
Shower elements	
Profiles	
Attachment elements	
Substructure element and sloping boards	
Drain systems	
Channel covers and frames	
Product overview	40

03 wedi design and shape

wedi Top Line	52
Fundo Top and accessories	
wedi Top Wall	
wedi Sanoasa Top	
wedi Sanwell Top	
wedi I-Board Top	
Design elements	56
Benches and seats	
Loungers	
Plumbing and bathroom furniture	
Product overview	60

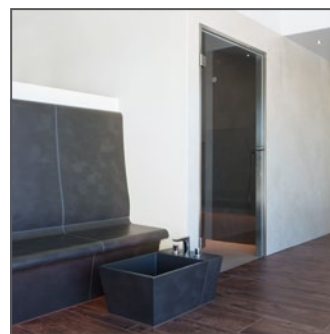
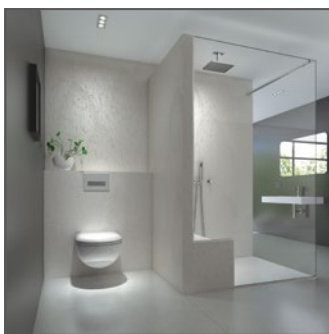

04 wedi building systems

Building boards.....	70
Building board, XL, XXL, Vapor 85, Vapor, Construct, PreLine	
Functional elements.....	72
Mensolo, Bathboard, I-Board, Sanwell niches	
Wall elements.....	75
Sanwell wall element, Wall elements for Fundo Trollo and Nautilo	
Product overview.....	76

05 wedi system accessories

Sealing in the wedi system.....	82
Adhesion..... 84 wedi 320, wedi 610	
Sealing and decoupling.....	84
wedi 620, wedi 520, Fundo sealing set, wall sealing set, sealing tape, corners, sloped lip-end sealing tapes, cut-resistant tape, sealing gaiters, butyl bathtub sealing tape, wedi Subliner, reinforcement tape	
Sound insulation.....	90
wedi Nonstep, edge insulation strips	
Product overview.....	92
Technical specifications.....	95
Installation instructions and videos, wedi Shower Configurator	

06 wedi customised & modular construction

Modular construction.....	98
Spa & Wellness.....	100

07 wedi services

Guarantee services.....	104
Reliability.....	106
Sustainability.....	107



Welcome to the world of wedi

Building, renovating and designing in a modular system

When my father Helmut Wedi founded wedi GmbH in 1983, he had one clear goal in mind: to develop high-quality and above all practical solutions for the trade which provide real added value to every wedi customer. Over the years, this goal has turned into a mission, a philosophy even, which has a decisive impact on the daily work of both me and my employees.

Thanks to our close proximity to the trade and our widespread presence, we are consistently able to respond to our customers' requirements on a rapid and straightforward basis. The system safety that we guarantee as well as the straightforward and time-saving processing take centre stage, while the feedback received from our clients provide the basis for further developments of our products, systems and services. Today, building, renovation and design with the modular wedi system means far more than just the wellknown wedi building board. It stands for complete solutions in the ever changing wet room environment as well as for numerous services in the areas of sales support and application technology that have turned wedi into a premium brand for the realisation of bathroom and wellness areas.



Stephan Wedi

Managing Director of wedi GmbH



wedi bathroom systems

The perfect base for creative room concepts

The modular wedi system offers an enormous variety of products for bathrooms and wet rooms: from wedi Fundo shower systems through design elements and construction systems to a wide range of system accessories. Each and every product is waterproof to its core and can be combined with one another the way you like – wedi's strength lies in its system concept.

There is a multitude of shower elements to choose from when planning for a flush-to-floor shower: as a classic shower tray or complete solution with integrated drain, optionally with point or linear drainage for example. In addition, there are numerous design possibilities for the entire bathroom, e.g. in the form of comfortable benches, stylish bathroom furniture, practical niches and stable partition walls.

The benefit: combination of individual products form a system that if used across the entire room become a complete wedi system – a whole bathroom from a single source designed individually according to your wishes.

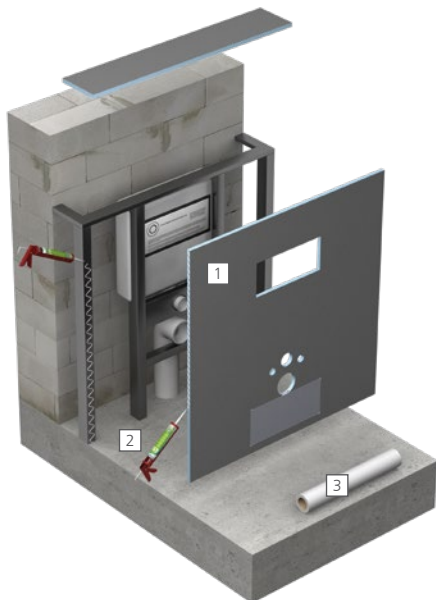

A System configuration for WC solution

wedi I-Board Plus is a prefabricated installation element for the cladding of wall-mounted WCs. With a width of 1.200 mm, it can be easily adapted to individual requirements. Despite being light weight, it is extremely strong and stable.

Products used

- 1 [wedi I-Board Plus](#) ▪ WC dry wall installation cladding prefabricated in the factory with reinforcement plates for plaster or mosaic tiling
- 2 [wedi 610](#) ▪ adhesive and sealant for the watertight adhesion of joints
- 3 [wedi Tools reinforcement tape](#) ▪ for reinforcement of joints and full-surface reinforcement of the front side



B

System configuration for shower situation

Not only are wedi Fundo shower elements available in a wide range of formats and drain versions (individually and as sets), they can also be extended in all directions as required.

Products used

- 1 wedi 610 ▪ adhesive and sealant for the watertight adhesion of joints and of Fundo Top to the shower element
- 2 wedi Sanwell Niches ▪ for creation of additional storage in the shower and bath
- 3 wedi Sanwell Top ▪ ready-to-use surface for Sanwell niches
- 4 wedi Tools sealing gaiter ▪ flexible sealing for pipes
- 5 wedi building board ▪ for designing wall solutions
- 6 Fundo Top ▪ ready-to-use surface for Fundo Plano shower elements
- 7 wedi Fundo sealing set ▪ for sealing of the perimeter of Fundo shower elements when connecting to adjacent surfaces
- 8 Fundo Plano ▪ extremely flat flush-to-floor shower element with integrated drain technology (point drainage)
- 9 wedi 320 ▪ for full-surface bonding of Fundo elements to the substrate
- 10 wedi edge insulation strips ▪ sound insulation for the area between wedi Fundo shower elements and the wall
- 11 wedi Nonstep ProS ▪ sound insulation mats for water impact noise reduction under wedi Fundo Shower elements

C

System configuration for bench and tray elements

The high individual stability of the wedi building boards as well as the simplicity of cutting them to the required dimensions down to the last millimetre allow for a multitude of design possibilities in the wet room.

Products used

- 1 wedi building board ▪ for configuring, cladding and creating construction components
- 2 wedi 610 ▪ adhesive and sealant for the watertight adhesion of joints
- 3 wedi Tools reinforcement tape ▪ for reinforcing joints

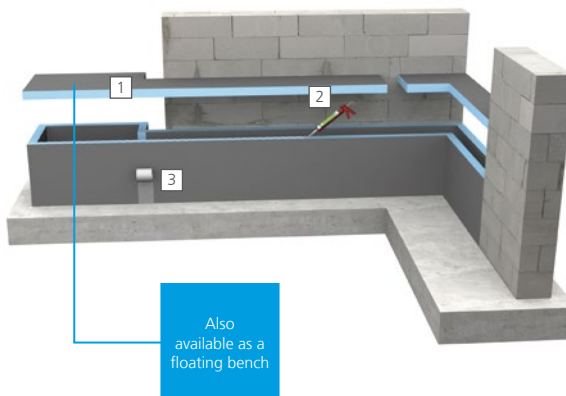



D System configuration for bath cladding

The prefabricated wedi Bathboard bath cladding has a 20 mm thickness that can be used for almost every bath format. Thanks to the height-adjustable feet, during the installation uneven areas of up to 10 cm can be safely levelled in bare concrete or screed. This makes the control frame superfluous.

Products used

- 1 **wedi building board** ▪ for the cladding of adjoining areas, e.g. as a retention wall
- 2 **wedi Tools sealing gaiter** ▪ flexible sealing for pipelines
- 3 **wedi 520** ▪ waterproof sealant for the sealing of wedi Tools sealing tapes
- 4 **wedi Tools cut-resistant tape** ▪ cut and stab-resistant self-adhesive tape to protect the sealing
- 5 **wedi Tools butyl bathtub sealing tape** ▪ for reliable sealing of tubs and shower trays, e.g. made from stainless steel or acrylic*
- 6 **wedi Bathboard** ▪ for height-adjustable cladding of head and side panels
- 7 **wedi 610** ▪ adhesive and sealant for the watertight adhesion of joints and wedi Top Wall surfaces
- 8 **wedi Tools reinforcement tape** ▪ for reinforcing joints
- 9 **wedi Top Wall** ▪ ready-to-use element for surface design

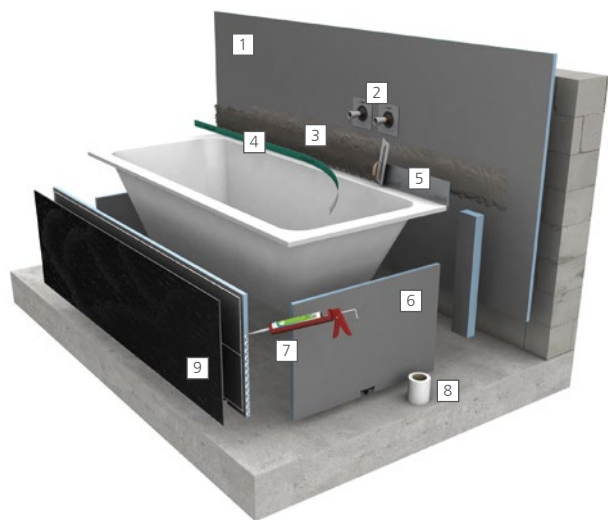

* For the adhesion and sealing of no 5, both no 3 and no 7 is sufficient

E

System configuration for shower situation

The high individual stability of wedi building boards as well as the simplicity of being able to cut them to the required dimensions allow for individual construction of tailor-made wash stand and shower solutions.

The highlights of this configuration are the design surfaces of the brand new wedi Top series. The natural stone look in anthracite black provides an elegant surface design on the floor and walls of the shower.

Products used

- 1 **wedi Top Wall** ▀ ready-to-use surface for walls
- 2 **wedi building board** ▀ for designing wall solutions and the exacting design of wash stand solutions
- 3 **wedi Tools reinforcement tape** ▀ for reinforcing joints
- 4 **wedi 610** ▀ adhesive and sealant for the watertight adhesion of joints and of the wedi Top Wall and the Fundo Top to wedi building boards and the shower element
- 5 **wedi 320** ▀ for full-surface bonding of Fundo elements and building boards to the substrate
- 6 Masonry
- 7 **wedi Fundo channel cover** ▀ Standard stainless steel, Exclusive solid stainless steel or Tileable options
- 8 **Fundo Top** ▀ ready-to-use surface for Fundo Riolito Neo shower elements
- 9 **wedi Fundo sealing set** ▀ for sealing of the perimeter of Fundo shower elements when connecting to adjacent surface
- 10 **Fundo Riolito Neo** ▀ flush-to-floor shower element with close-to-wall linear drainage
- 11 **wedi edge insulation strips** ▀ sound insulation for the area between wedi Fundo shower elements and the wall
- 12 **wedi Nonstep ProS** ▀ sound insulation mats for water impact noise reduction under wedi Fundo shower elements

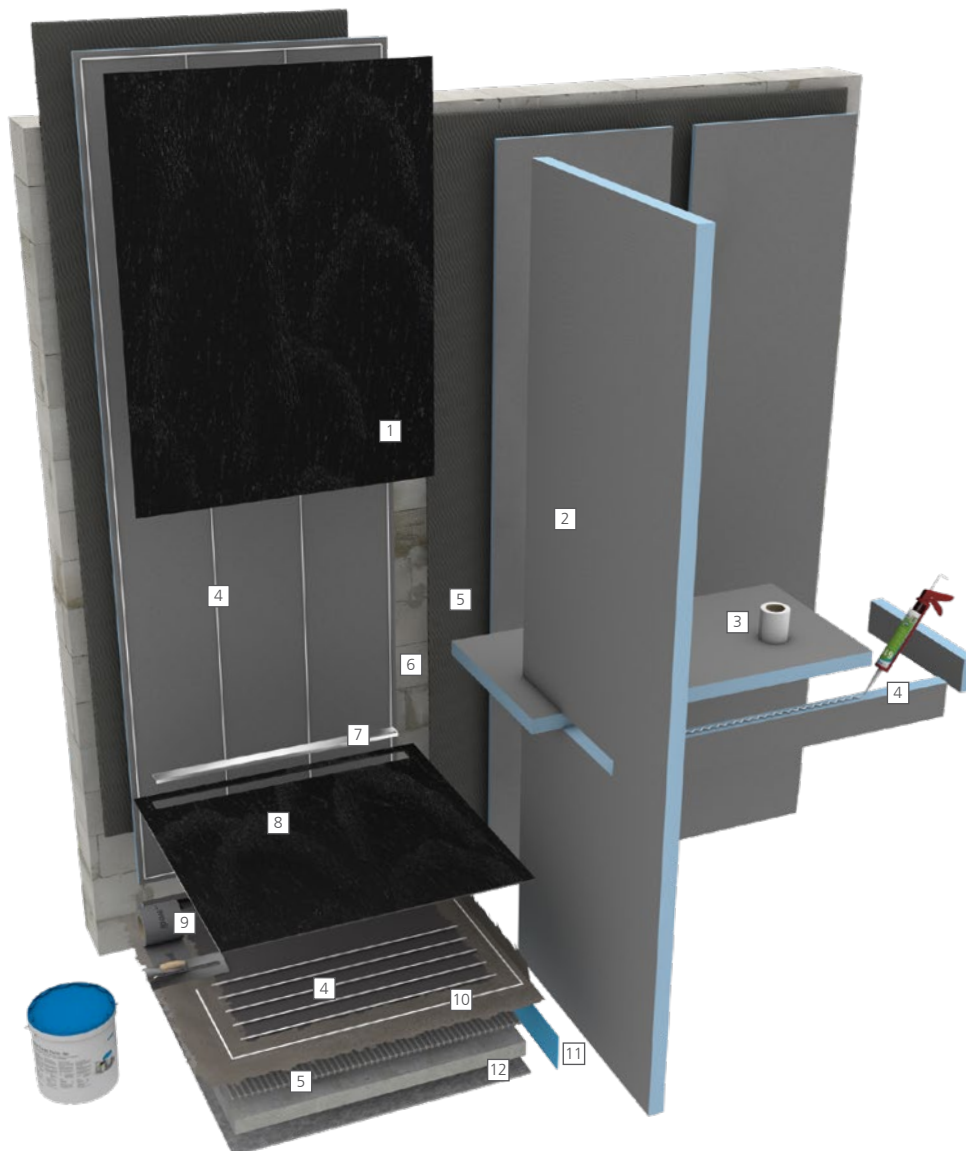



F Technical wall system configuration

wedi technical walls, produced individually to customers' specifications, massively simplify and speed up installation and offer long-lasting reliability. Both the size and thickness can be freely chosen, as can any recess for fittings, power cables, hot and cold water pipes or reinforcement plates for fitting heavier objects such as glass doors and wall heaters.

Products used

- 1 [wedi Technical wall](#) ▪ individually produced wall element in the desired size and thickness including recesses for supply lines and integrated reinforcement plates
- 2 [wedi Tools fixings set](#) ▪ reinforcement plates for mounting of heavy objects such as wall heaters and glass doors (available as a separate product or integrated into the wedi technical wall)
- 3 [wedi XXL building board](#) ▪ as free-standing partition wall, building board thickness 50 mm
- 4 [wedi Top Wall](#) ▪ ready-to-use element for surface design



G

Hot water heating system configuration

wedi PreLine is a base element for quick and waterproof implementation of hot water heating systems (recommendation: aluminium PEX Ø 16 mm) and thermal insulation in one. The element can be tiled, saving the laborious application of screed and reducing the construction height of the floor structure to a minimum. The wedi PreLine is available in four thicknesses (30, 40, 50, 60 mm) and is therefore particularly suitable for renovations.

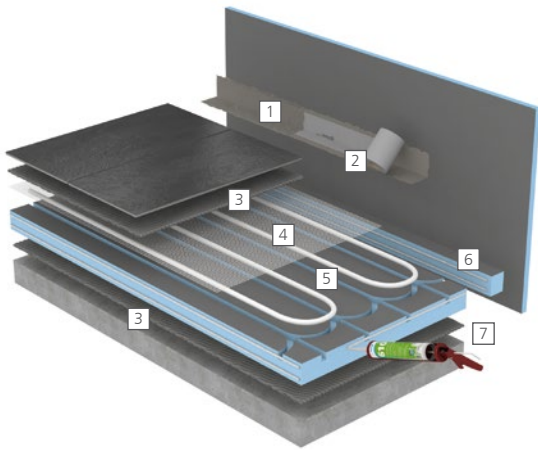

Products used

- 1 wedi 520 ▪ waterproof sealant for the sealing of wedi Tools sealing tapes
- 2 wedi Tools sealing tape ▪ for reliable sealing of intersections and butt joints
- 3 wedi 320 ▪ tile adhesive for bonding wedi PreLine to the screed floor and for backfilling the pipe ducts
- 4 wedi Tools reinforcement tape, self-adhesive ▪ for reinforcement of the entire surface
- 5 wedi PreLine ▪ prefabricated building board element for hot water heating systems
- 6 wedi building board ▪ edge strips for sealing in the wall area
- 7 wedi 610 ▪ adhesive sealant for filling intersections and for sealing the joint areas between the wedi PreLine elements

G

System configuration for floor construction

Stable, decoupling, insulating and height-compensating – wedi building boards are also ideal for floor applications and thanks to their various formats they are perfectly suited to any renovation project.

Products used

- 1 wedi Tools reinforcement tape ▪ for reinforcing joints and surfaces
- 2 wedi building board ▪ as thermally insulating flooring
- 3 wedi 610 ▪ adhesive and sealant for the watertight adhesion of joints
- 4 wedi 320 ▪ for full-surface bonding of building boards to the substrate

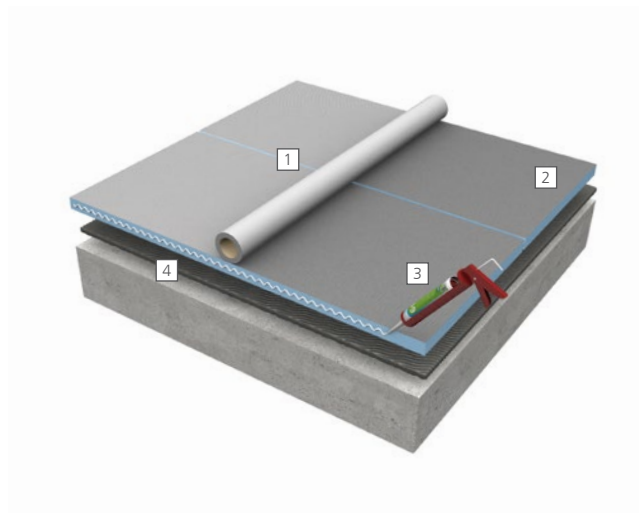



wedi Fundo[®] shower systems

Flush-to-floor showers for the strictest requirements

Whether shower systems with point drainage or linear drainage, with a classic shower element or a complete system including integrated drain technology: the vast range of the wedi Fundo series offers the right solution for the most challenging situations – a flush-to-floor shower tailored to your wishes – within one range that meets the high demands of planners, fitters and builders equally.

- Wide choice of designs, functions and formats
- 100 % waterproof in the complete system
- Can be adapted individually without voiding the guarantee
- High system reliability with manufacturer's warranty
- Easy installation and sealing with appropriate wedi system accessories
- Configure flush-to-floor showers online, order products and get started

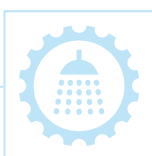

You can plan your shower quickly and easily online with the wedi Shower Configurator. The practical tool guides you through the various possibilities step by step and recommends the right wedi product for your individual initial situation.



wedi.de/en/shower-configurator

Classic system

Floor-level shower, for example with Fundo Primo®

The classic system consists of a wedi Fundo shower element with point or linear drainage and the matching drain, which is available separately in different versions. The scope of delivery for point drains always includes a standard drain grid, designer drain grids, also available in the Fundo range, can be ordered optionally at an extra cost. The linear drainage channel covers are not part of the scope of delivery and must be purchased in addition. Sealing of the wedi Fundo shower element to the adjacent surfaces is done with the Fundo sealing set, comprising wedi 520, wedi Tools sealing tape and wedi Tools sealing corners.

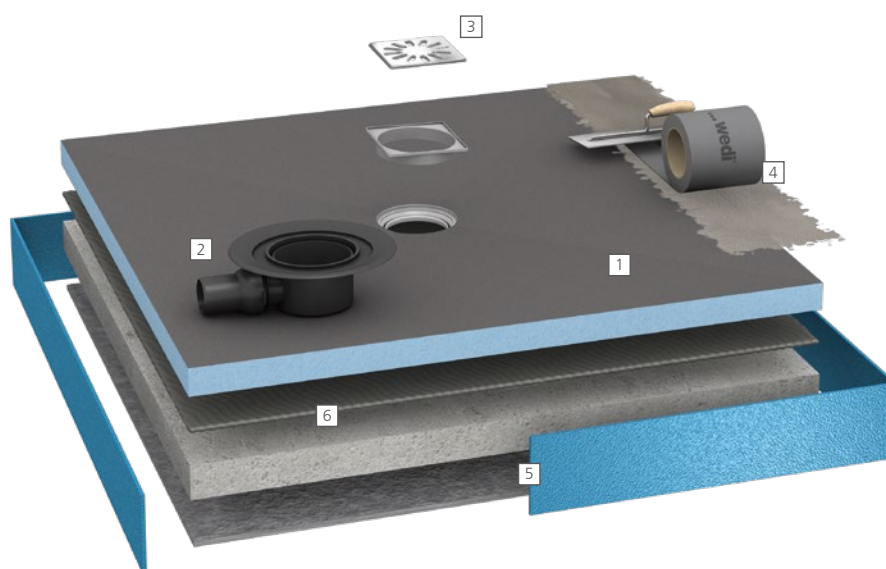

- 1 Shower element ▪ e.g. Fundo Primo with classic point drainage
- 2 Drainage ▪ e.g. Fundo point drain DN 50 horizontal
- 3 Drain cover ▪ e.g. standard drain grid, which is included in the scope of delivery for the wedi Fundo point drain
- 4 Seal ▪ e.g. with the wedi Fundo sealing set, consisting of wedi 520, wedi Tools sealing tape and wedi Tools sealing corners
- 5 Sound insulation ▪ e.g. with the combination of wedi edge insulation strips and the wedi Nonstep ProS sound-insulation mat
- 6 Tile adhesive ▪ e.g. wedi 320 for full-surface bonding of the Fundo shower element on the cement-bonded fill

Complete system

Floor-level shower, for example with Fundo Plano®

The complete system with point or linear drainage has a drain integrated into the shower element in the factory. The matching drain grid and sealing tools are already included in the scope of delivery. Sealing of the complete system to the adjacent surfaces is done with the wedi Fundo sealing set, comprising wedi 520, wedi Tools sealing tape and wedi Tools sealing corners.

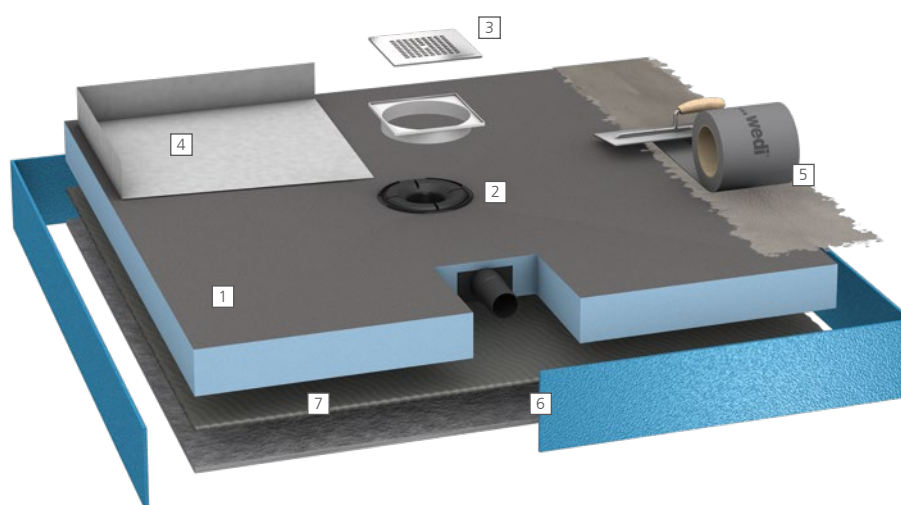

- 1 Shower element ▪ e.g. Fundo Plano, complete system with integrated drainage
- 2 Drainage ▪ the drainage is factory integrated into the Fundo Plano shower element
- 3 Drain cover ▪ a standard grate is included in the scope of delivery with the Fundo Plano
- 4 Sealing sheet ▪ especially for sealing the pipe connection (included in the scope of delivery)
- 5 Seal ▪ e.g. with the wedi Fundo sealing set, consisting of wedi 520, wedi Tools sealing tape and wedi Tools sealing corners
- 6 Sound insulation ▪ e.g. with the combination of wedi edge insulation strips and the wedi Nonstep ProS sound-insulation mat
- 7 Tile adhesive ▪ e.g. wedi 320 for full-surface bonding of the Fundo shower element on the cement-bonded fill



Point shower systems



The very essence of quality

Point drainage system configuration

wedi provides all of the components required to create a fully waterproof shower area with point drainage – from flush-to-floor shower elements through matching drains and grids to surface finishes – there are various designs, functions and formats to choose from. All wedi system components are compatible with one another and 100% waterproof in the complete system. For long-lasting reliability with a manufacturer's warranty.

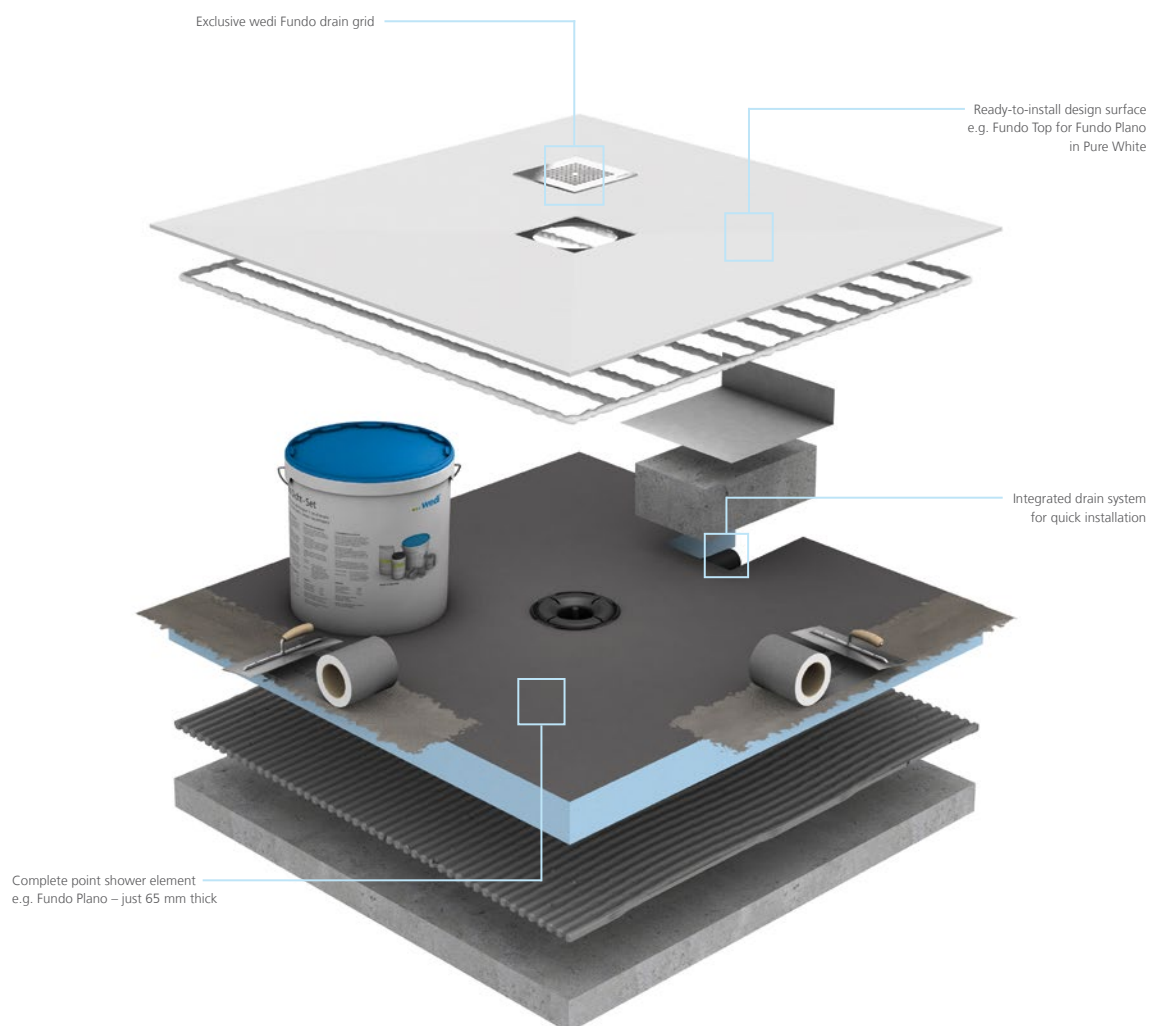



wedi Shower Configurator
Configure. Order.
Install. Finish!

Fundo Top® Slim-Kit

The Fundo Top Slim-Kit combines a high-quality Fundo Top ready-to-use mineral surface with a tried and tested Fundo shower element. Its main character is the low construction height of the entire system – the combined height of these two elements is only 30 mm. This unique combination offers a high degree of flexibility during installation: it can be easily cut to required dimensions and can be installed either on top of or flush with the existing substrate including suspended timber floors. Skirting strips for cladding of the visible edges on step-up shower installations plus accessories for sealing and adhesion are also included in the kit to simplify the installation process.

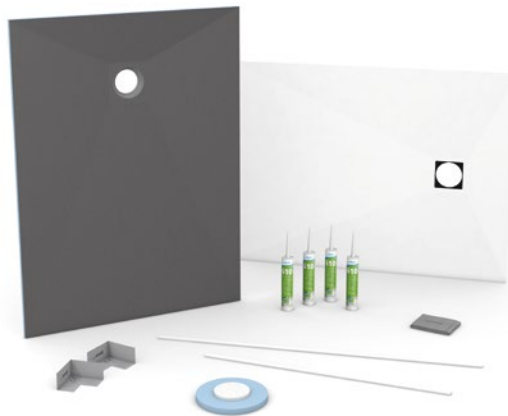

Fundo Plano®

With an installation height of just 65 mm, Fundo Plano is the slimmest complete wedi shower system with integrated DN 40 drainage. Thanks to the low installation height, it is particularly suitable for renovation of old buildings where every millimetre counts. It also offers all the advantages of more than 30 years of tried and tested wedi products – from the guaranteed 100 % watertightness through to the straightforward and time-saving application.

Perfect for renovations

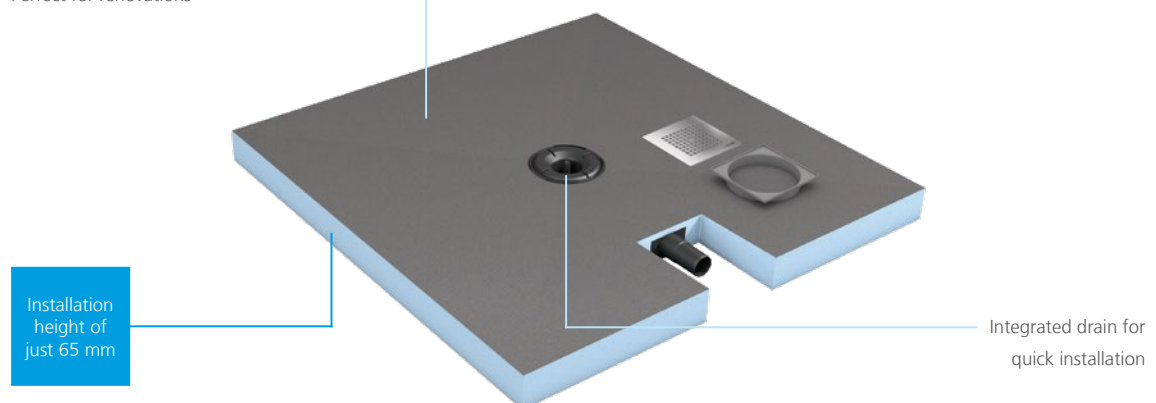



Fundo Integro®

The Fundo Integro is another flush-to-floor shower element with integrated drain technology, featuring a 50 mm water trap height, a drain capacity of 0.8 litres per second, at least 1.5 % even pre-formed gradient and 100 % waterproof material. This complete wedi shower system not only fulfils all relevant standards but offers an overall installation height of just 90 mm! The Fundo Integro is simply the perfect solution for all renovation projects, as well as a reliable and time-saving alternative for every installation.

Maximum reliability thanks to integrated drain technology

Installation height of just 90 mm

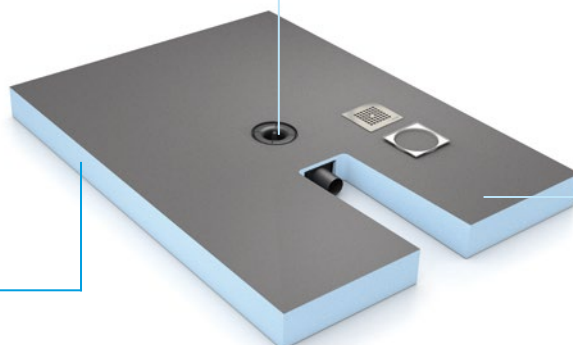

Complies with all current standards and guidelines

Fundo Primo®

The founding member of the Fundo family is available in a wide variety of different sizes for classic point drainage in the shower. Whether square or rectangular, with a central, offset or corner drain, Fundo Primo shower elements offer an ideal solution for any space and can easily be rounded out to form a complete shower area with the help of wedi building boards, for example. The wedi Fundo series also offer a range of drainage (horizontal, horizontal extra-flat and vertical) as well as a selection of designer drain grids.

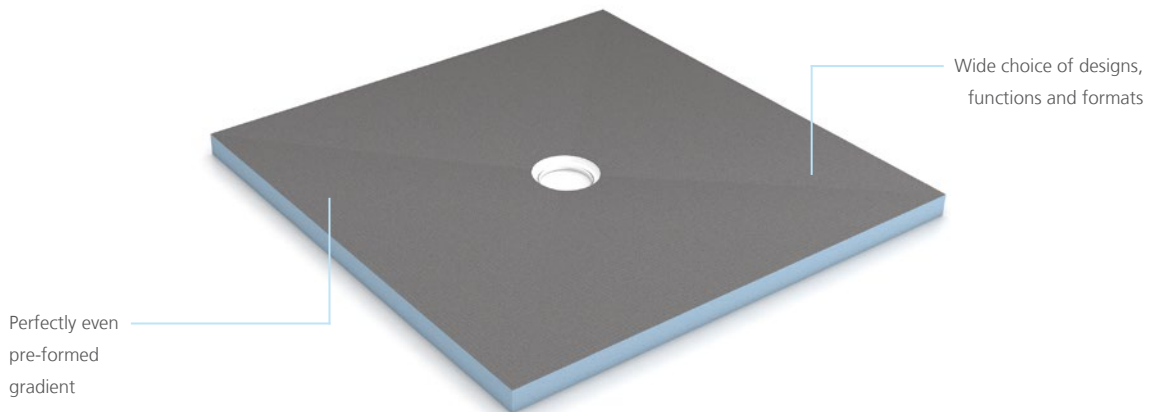

Fundo Ligno®

The Fundo Ligno shower element with outer edges of just 20 mm has been specially developed for use in existing and new builds with wooden floors. In contrast to traditional shower elements, the wedi Fundo Ligno is adapted to the covering wood layer and as a result can be integrated into it wonderfully without cutting into floor joists or building up further height.

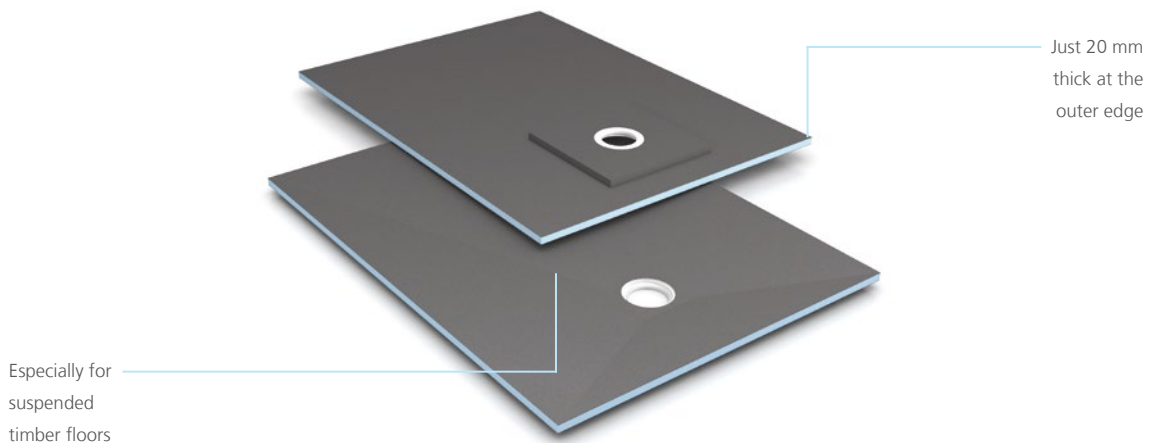

Fundo Borgo®, Trollo® and Nautilo®

Wet rooms offer a visual highlight with high functionality – Fundo designer shower elements, Borgo, Trollo and Nautilo unite creative linear guidance with natural shapes and can also be combined with matching wall elements allowing them to be placed even in the middle of the room! The shower is turned into a feature and becomes the absolute highlight of the bathroom.

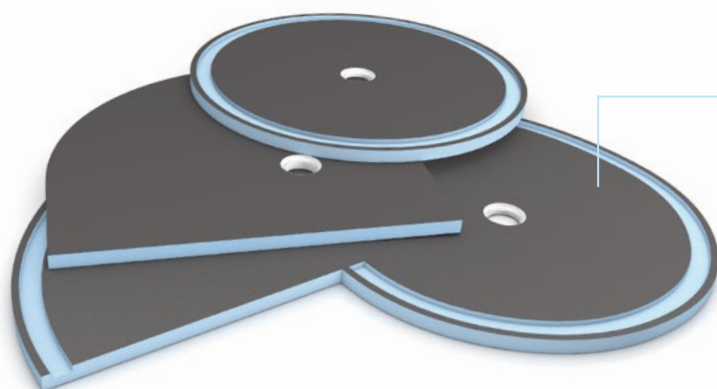

Creative shapes with high functionality



wedi Fundo® drain-substructure element

The wedi Fundo drain-substructure element eliminates any possibility of failure resulting from poor positioning of the drain body. It guarantees reliable support and accurate aligning of the drain and thus time consuming building and filling with mortar and screed is not required.

Quickly and reliably installed

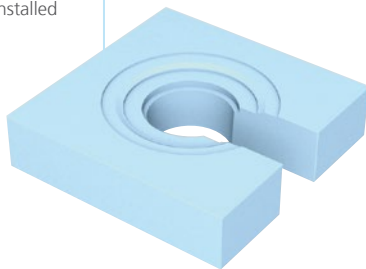

wedi Fundo® substructure set

Flush-to-floor shower elements in the wedi Fundo range can be brought to the right height using the wedi Fundo substructure set. Each set allows for substructure heights of 30, 60 and 90 mm to be created easily and reliably. Exterior dimensions, drain and pipe position can be individually adjusted on site.

Quick and easy to adjust on site

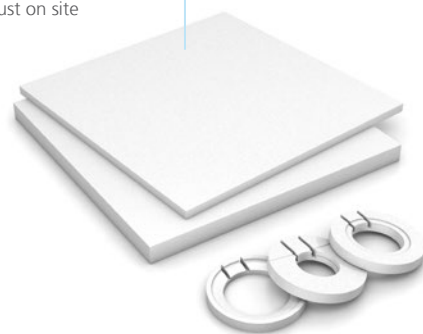

wedi Fundo® sloping board

The wedi Fundo sloping board is used for on-site extension of the Fundo Primo shower elements and therefore expansion of the shower area. It is available in two different thicknesses, the slope is 1.00%.

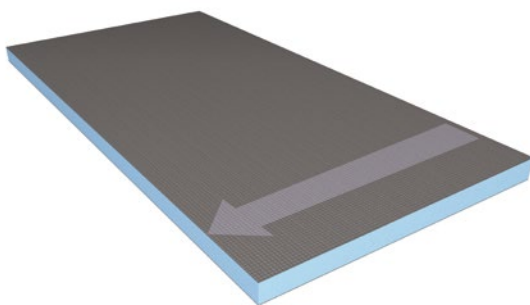

wedi Fundo® point drains

wedi Fundo point drains are available in a range of variants for vertical and horizontal implementation with various diameters and installation heights. Vertical drains with fire protection collar are also available for improved fire protection. A suitable standard drain grid is included in the scope of delivery for all products.

Vertical and horizontal designs



Exclusive drain covers for point drainage

Whether round or square in shape (optionally screw in), as a standard version or in solid stainless steel – the wedi drain grids are the perfect solution for all tile shapes and colours and are always supplied with the appropriate frame, in stainless steel or plastic depending on type. The wedi Fundo drain grid 7.1 with blackened channel is an optical highlight here.

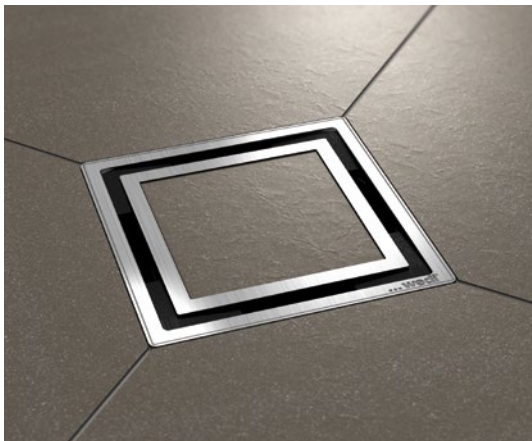

wedi Fundo drain grid 7.1



wedi Fundo drain grid 1.1



wedi Fundo drain grid 2.1



wedi Fundo drain grid 5.1



wedi Fundo drain grid 4.2



wedi Fundo drain grid 3.2

More designs can be found on page 42/43 and in the current wedi price list.



Linear shower systems



Design oriented linear elegance

Linear drainage system configuration

wedi offers all components for the creation of a sophisticated shower area with stylish linear drainage optionally with the drainage channel close to the wall, at a distance from the wall or at the centre. There is a selection of matching drains, channel covers and even surface finishes to choose from. All wedi system components are compatible with one another and 100 % waterproof in the complete system. For long-lasting reliability with a manufacturer's warranty.

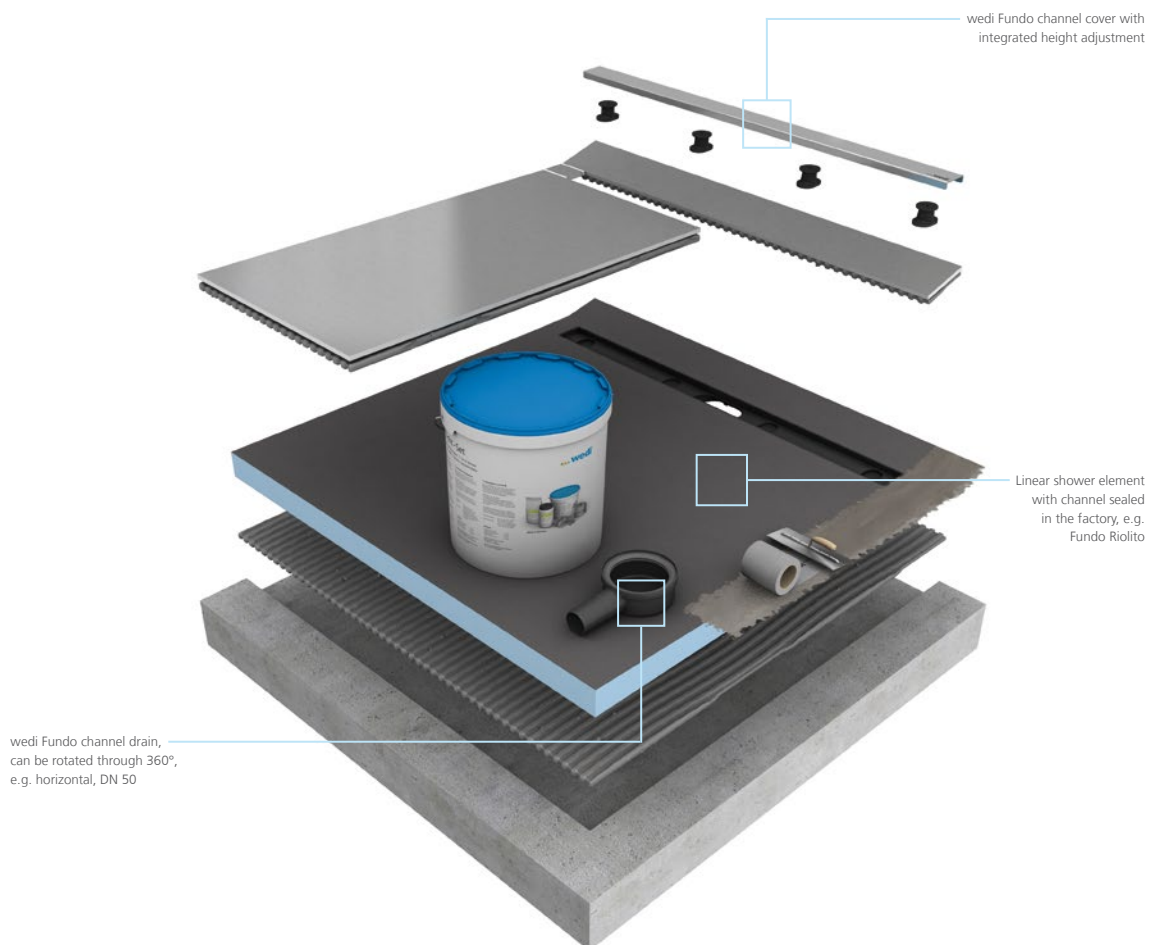



wedi Shower Configurator
Configure. Order.
Install. Finish!



Fundo Plano® Linea

Featuring modern linear drainage, the Fundo Plano Linea offers a total installation height of just 70 mm, a precisely defined slope and 40 mm water trap height. Its linear drainage is positioned very close to the wall and is available in various sizes with either a short or long channel.

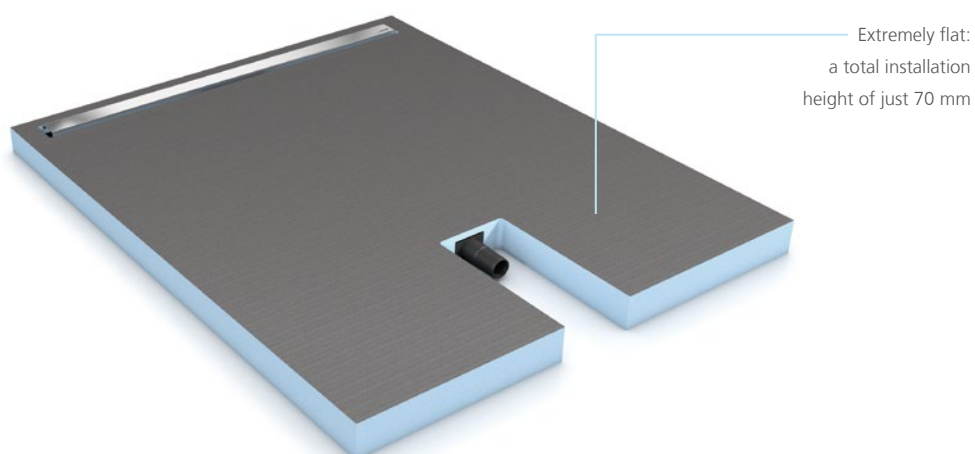

Fundo Riolito® Neo

The Fundo Riolito Neo is a flush-to-floor shower element with a channel drain close to the wall which allows the shower water to run off in a slender line. The gradient required for this is already integrated into the shower elements and enables almost seamless laying of large format tiles in a wide variety of thicknesses (5 – 25 mm).

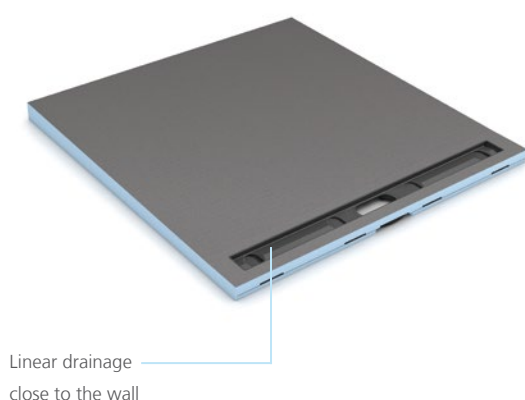

Fundo Riolito®

The Fundo Riolito captivates with its simple elegance – featuring a near-to-wall linear drainage channel that is completed by a height-adjustable channel cover in either standard stainless steel, exclusive or tileable design. A pre-formed even slope is already integrated into the shower element during the manufacturing process.

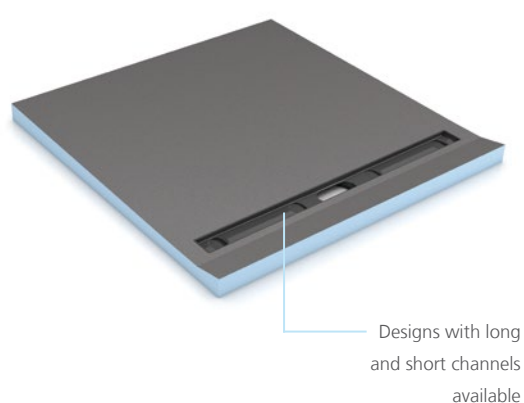

Fundo RioLigno

The flush-to-floor shower element with linear drainage, which is just 25 mm thick at the outer edge, was specially developed for use in suspended timber floors which are sensitive to moisture. In contrast to conventional shower elements, the Fundo RioLigno is tailored to the covering layer of wood and so can easily be integrated into this – without removing additional height and without time-consuming levelling measures.

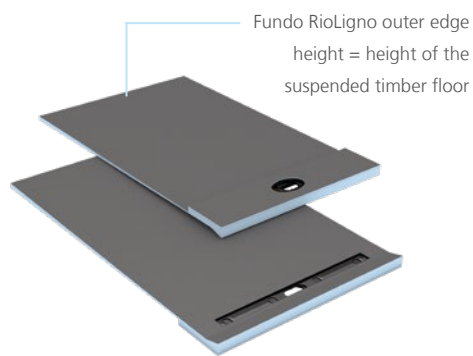

Fundo Riofino®

A different kind of linear drainage – streamlined and centred. Although it does not offer various channel lengths, the Fundo Riofino shower element impresses with its extraordinary design and sophisticated finish. It's available with height-adjustable stainless steel channel covers in standard, exclusive or tileable design.

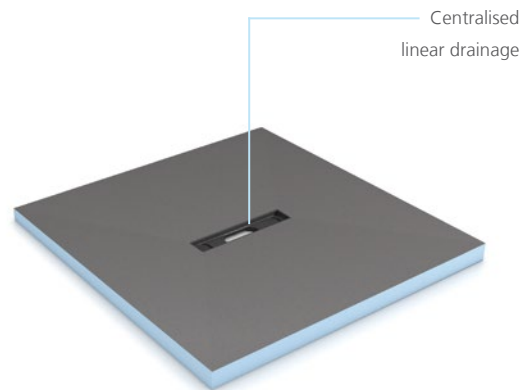

wedi Fundo® slope and end profiles for Fundo Riolito® Neo, Plano® Linea / wedi Fundo® slope profiles for Fundo Riolito®

When installing flush to floor showers, it quickly becomes necessary to adapt the tiles to the gradient of the shower element. Thanks to wedi slope and end profiles, costly chamfering and cutting of wall tiles is a thing of the past. Especially designed for the Fundo Riolito, Fundo Riolito Neo, and Fundo Plano Linea shower elements, wedi profiles are trimmable and allow for a perfect transition in all directions thus provide a high-quality connection to the adjoining floor/wall tiles. The profiles are available in both right and left versions as well as in different heights.

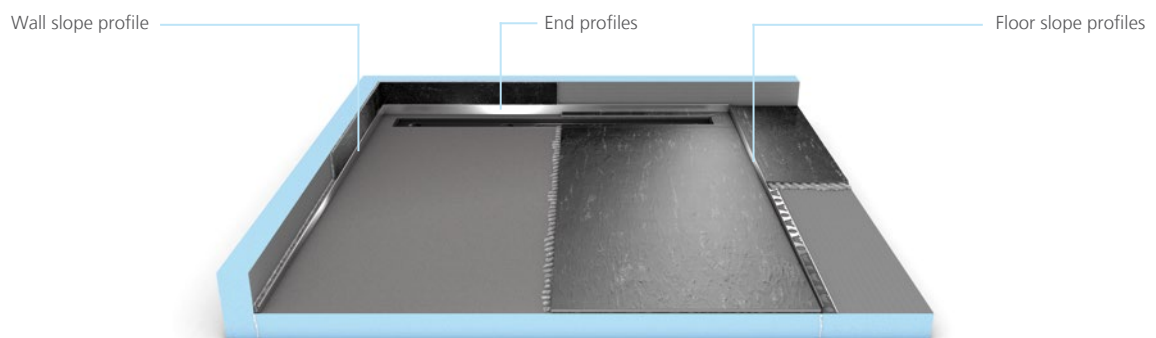

Fundo Discreto® attachment element

The Fundo Discreto is an attachment element that allows the channel to disappear and thus creates an optical illusion of the water draining away into the wall. Especially developed for the Fundo Riolito, Riolito Neo and Plano Linea shower elements, it features a two-sided channel cover offering a stainless steel and a tileable option that can be changed even after installation. Thanks to the technical features, installation is easier than ever and the variation is as great as possible thanks to the additional models with channel lengths of between 300 and 1.100 mm.

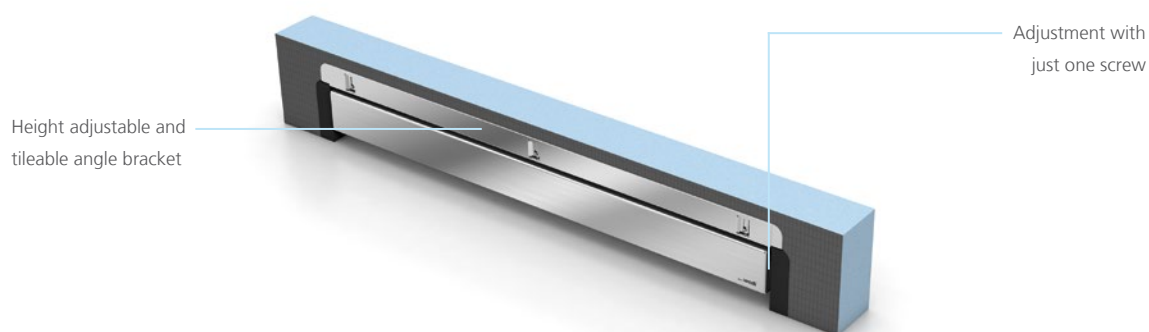

wedi Fundo® channel drain substructure element

The wedi Fundo channel drain-substructure element eliminates any possibility of failure resulting from poor positioning of the drain body. It guarantees reliable support and accurate aligning of the drain and thus time consuming building and filling with mortar and screed is not required.

Quickly and reliably installed

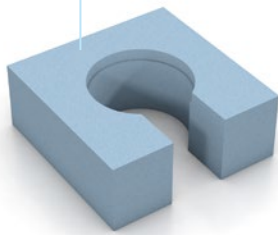

wedi Fundo® substructure set

Flush-to-floor shower elements in the wedi Fundo range can be brought to the right height using the wedi Fundo substructure set. Each set allows for substructure heights of 30, 60 and 90 mm to be created easily and reliably. Exterior dimensions, drain and pipe position can be individually adjusted on site.

Quick and easy to adjust on site

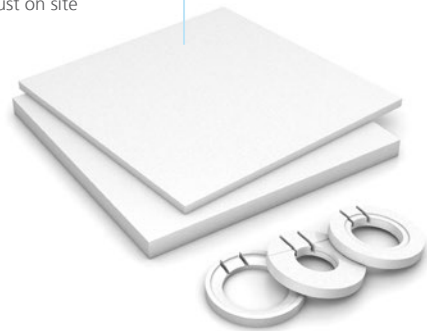

wedi Fundo® sloping board

The wedi Fundo sloping board is used for on-site extension of the Fundo Riolito, Riolito Neo and Riofino shower elements and therefore expansion of the shower area. The slope is 1.70%.

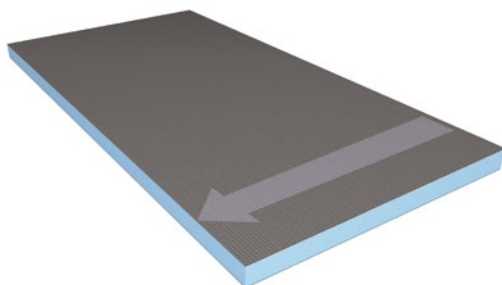

wedi Fundo® channel drains

wedi Fundo channel drains are available in a range of variants for vertical and horizontal implementation with various diameters and installation heights. Vertical channel drains with fire protection collar are also available for improved fire protection. Channel covers must be purchased separately due to variety of sizes and designs.

All channel drains rotatable through 360°



wedi Fundo® channel cover standard plus

An easy-to-install and attractive frame solution which hides open tile edges and enhances the overall look. The wedi Fundo channel frame convinces with its simple yet clever design. Made from brushed stainless steel for easy maintenance and sophisticated finish, it offers a seamless height adjustment for tile thicknesses from 6 to 20 mm. This wedi system component is available in five different sizes either individually or in a set with the matching wedi Fundo standard channel cover.



High quality wedi Fundo® channel covers for linear drainage

A close-to-wall linear drainage system is an aesthetically pleasing, elegant alternative to conventional shower trays. The shower becomes a highlight as the drainage channel is enhanced with wedi channel covers which are available in standard, exclusive and tileable variants.

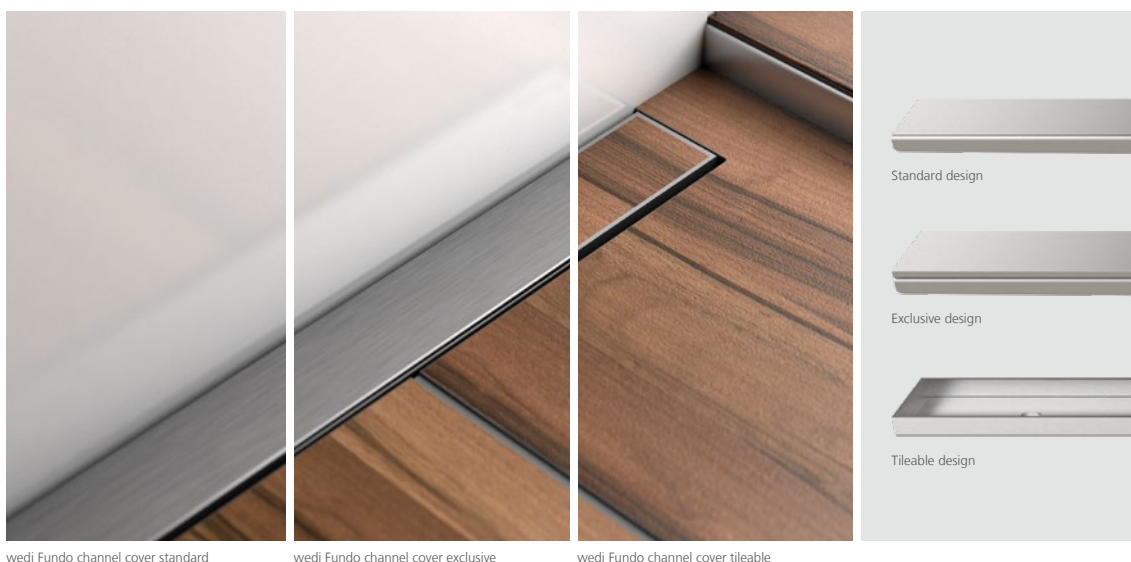

wedi Fundo channel cover standard

wedi Fundo channel cover exclusive

wedi Fundo channel cover tileable

Product overview

Fundo Top Slim-Kit

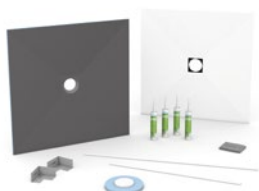

square

900 × 900 × 30 mm
1.200 × 1.200 × 30 mm

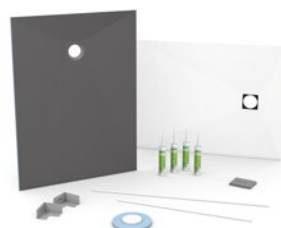

rectangular

1.200 × 900 × 30 mm
1.400 × 900 × 30 mm
1.600 × 1.000 × 30 mm
1.800 × 900 × 30 mm

Fundo Integro



square, central

900 × 900 × 90 mm
1.000 × 1.000 × 90 mm
1.200 × 1.200 × 90 mm



rectangular, offset

1.200 × 900 × 90 mm
1.400 × 900 × 90 mm
1.600 × 1.000 × 90 mm
1.800 × 900 × 90 mm



rectangular, central, short side connection

1.200 × 900 × 90 mm



rectangular, central, long side connection

1.200 × 900 × 90 mm

Fundo Plano



square, central

900 × 900 × 65 mm
1.000 × 1.000 × 65 mm
1.200 × 1.200 × 65 mm



rectangular, offset

1.400 × 900 × 65 mm
1.600 × 1.000 × 65 mm



rectangular, central, short side connection

1.200 × 900 × 65 mm



rectangular, central, long side connection

1.200 × 900 × 65 mm

Fundo Primo**square, central**

800 × 800 × 40 mm
 900 × 900 × 40 mm
 1.000 × 1.000 × 40 mm
 1.200 × 1.200 × 40 mm
 1.500 × 1.500 × 40 mm

**square, corner**

900 × 900 × 40 mm
 1.000 × 1.000 × 40 mm
 1.200 × 1.200 × 40 mm
 1.500 × 1.500 × 40 mm

**rectangular, central**

900 × 750 × 40 mm
 1.200 × 900 × 40 mm
 1.200 × 1.000 × 40 mm
 1.400 × 900 × 40 mm
 1.400 × 1.000 × 40 mm
 1.500 × 900 × 40 mm
 1.500 × 1.000 × 40 mm
 1.800 × 900 × 40 mm

**rectangular, offset**

1.200 × 900 × 40 mm
 1.400 × 900 × 40 mm
 1.600 × 900 × 40 mm
 1.600 × 1.000 × 40 mm
 1.800 × 900 × 40 mm
 2.000 × 1.000 × 40 mm

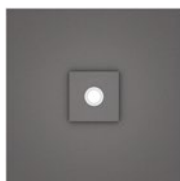
Fundo Ligno**square, central**

900 × 900 × 20/41 mm
 1.000 × 1.000 × 20/41 mm
 1.200 × 1.200 × 20/41 mm
 1.500 × 1.500 × 20/41 mm

**square, corner**

900 × 900 × 20/41 mm
 1.200 × 1.200 × 20/41 mm

**rectangular, offset**

1.200 × 900 × 20/41 mm
 1.200 × 1.000 × 20/41 mm
 1.600 × 900 × 20/41 mm
 1.600 × 1.000 × 20/41 mm

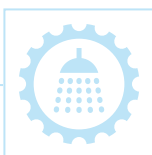

You can plan your shower quickly and easily online with the wedi Shower Configurator. The practical tool guides you through the various possibilities step by step and recommends the right wedi product for your individual initial situation.

www.wedi.de/en/shower-configurator



Fundo Borgo

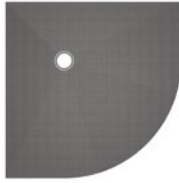

quadrant, offset
900 × 900 × 40 mm
1.000 × 1.000 × 40 mm

Fundo Trollo



round, central
Ø 1.140 × 40 mm

Fundo Nautilo

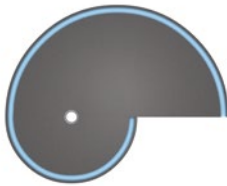

**shell-shaped,
entry right**
1.890 × 1.515 × 50 mm

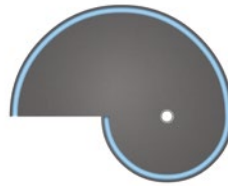

**shell-shaped,
entry left**
1.890 × 1.515 × 50 mm

wedi Fundo substructure



substructure set
900 × 900 × 90 mm
1.200 × 1.200 × 90 mm
1.500 × 1.500 × 90 mm

drain-substructure element
338 × 338 × 82 mm

wedi Fundo sloping board

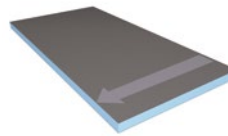

for Fundo Primo
1.200 × 600 × 40/46 mm
1.200 × 600 × 46/52 mm

wedi Fundo point drain



vertical, DN 50/DN 70
Mini Max, horizontal, DN 40
horizontal, DN 50

wedi Fundo point drain fire protection collar



vertical, DN 50/DN 70

wedi Fundo drain grid, stainless steel



1.1
115 × 115 × 5 mm

1.3, screw in
115 × 115 × 5 mm



1.2, round
Ø 115 × 5 mm

wedi Fundo drain grid, stainless steel



2.1
115 × 115 × 5 mm

2.3, screw in
115 × 115 × 5 mm



2.2, round
Ø 115 × 5 mm

wedi Fundo drain grid, stainless steel



3.1
115 x 115 x 5 mm

3.3, screw in
115 x 115 x 5 mm



3.2, round
Ø 115 x 5 mm

wedi Fundo drain grid, solid stainless steel



4.1
115 x 115 x 5 mm



4.2
Ø 115 x 5 mm

wedi Fundo drain grid, solid stainless steel



5.1
115 x 115 x 5 mm



6.1, extraflach
115 x 115 x 2.5 mm

wedi Fundo drain grid, solid stainless steel

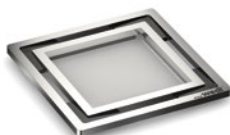

7.1, tileable
115 x 115 x 5 mm

wedi Fundo frame



square
120 x 120 x 10 mm
120 x 120 x 6.2 mm



round
Ø 120 x 9 mm
Ø 120 x 2 mm

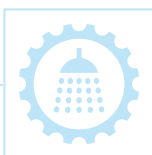

You can plan your shower quickly and easily online with the wedi Shower Configurator. The practical tool guides you through the various possibilities step by step and recommends the right wedi product for your individual initial situation.

www.wedi.de/en/shower-configurator



Fundo Plano Linea

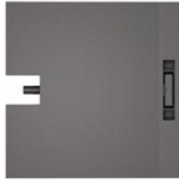

square, close to the wall
channel length 300 mm
900 × 900 × 70 mm



square, close to the wall
channel length 800 mm
900 × 900 × 70 mm

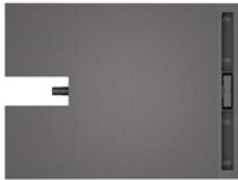

rectangular,
close to the wall
channel length 700 mm
1.200 × 800 × 70 mm

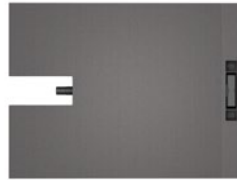

rectangular,
close to the wall
channel length 300 mm
1.200 × 900 × 70 mm

channel length 800 mm
1.200 × 900 × 70 mm

channel length 900 mm
1.200 × 1.000 × 70 mm

Fundo Riolito Neo



square, close to the wall
channel length 300 mm
900 × 900 × 50 mm

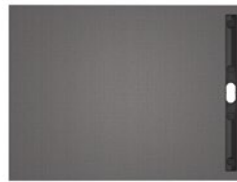

rectangular,
close to the wall
channel length 700 mm
1.200 × 800 × 50 mm
1.400 × 900 × 50 mm



square, close to the wall
channel length 800 mm
900 × 900 × 50 mm
1.000 × 1.000 × 50 mm

channel length 800 mm
1.200 × 900 × 50 mm
1.600 × 1.000 × 50 mm
1.800 × 900 × 60 mm

channel length 1.100 mm
1.200 × 1.200 × 50 mm

channel length 900 mm
1.200 × 1.000 × 50 mm

Fundo Riolito



square, at a distance
from the wall
channel length 300 mm
900 × 900 × 50 mm



rectangular, at a distance
from the wall
channel length 700 mm
1.200 × 800 × 50 mm
1.400 × 900 × 50 mm



square, at a distance
from the wall
channel length 800 mm
900 × 900 × 50 mm
1.000 × 1.000 × 50 mm

channel length 800 mm
1.200 × 900 × 50 mm
1.600 × 1.000 × 50 mm
1.800 × 900 × 60 mm

channel length 1.100 mm
1.200 × 1.200 × 50 mm

channel length 900 mm
1.200 × 1.000 × 50 mm

Fundo Rioligno

**square, at a distance
from the wall**
channel length 700 mm

900 × 900 × 25 mm

channel length 900 mm
1.200 × 1.200 × 25 mm



**rectangular, at a distance
from the wall**
channel length 700 mm

1.200 × 900 × 25 mm

channel length 800 mm
1.600 × 1.000 × 25 mm

Fundo Riofino

square, central
900 × 900 × 50 mm
1.000 × 1.000 × 50 mm
1.200 × 1.200 × 50 mm



rectangular, central
1.200 × 900 × 50 mm
1.800 × 900 × 50 mm

wedi Fundo substructure

substructure set
900 × 900 × 90 mm
1.200 × 1.200 × 90 mm
1.500 × 1.500 × 90 mm

**channel drain
substructure element**
240 × 240 × 82 mm

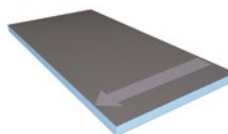
wedi Fundo sloping board

**for Fundo Riolito,
Riolito Neo, Riofino**
1.200 × 600 × 50/60 mm

wedi Fundo channel drain

vertical, DN 50
Mini Max, horizontal, DN 40
horizontal, DN 50

wedi Fundo channel drain fire protection

vertical, DN 50

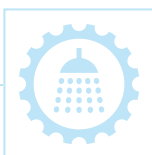

You can plan your shower quickly and easily online with the wedi Shower Configurator. The practical tool guides you through the various possibilities step by step and recommends the right wedi product for your individual initial situation.

www.wedi.de/en/shower-configurator



Fundo Discreto

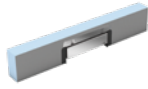

**300 mm,
attachment element**
900 × 154 × 80 mm



**900 mm,
attachment element**
1.000 × 154 × 80 mm



**700 mm,
attachment element**
900 × 154 × 80 mm

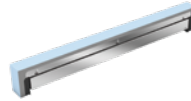

**1.100 mm,
attachment element**
1.200 × 154 × 80 mm



**800 mm,
attachment element**
1.000 × 154 × 80 mm

wedi Fundo channel cover



standard, stainless steel
290 × 45 × 13 mm
690 × 45 × 13 mm
790 × 45 × 13 mm
890 × 45 × 13 mm
1.090 × 45 × 13 mm



**exclusive,
solid stainless steel**
290 × 45 × 13 mm
690 × 45 × 13 mm
790 × 45 × 13 mm
890 × 45 × 13 mm
1.090 × 45 × 13 mm

wedi Fundo channel cover



tileable, stainless steel
290 × 45 × 13 mm
690 × 45 × 13 mm
790 × 45 × 13 mm
890 × 45 × 13 mm
1.090 × 45 × 13 mm

wedi Fundo channel frame



stainless steel
300 × 6 × 6 mm
700 × 6 × 6 mm
800 × 6 × 6 mm
900 × 6 × 6 mm
1.100 × 6 × 6 mm

wedi Fundo channel cover standard plus



**stainless steel
incl. channel frame**
300 mm
700 mm
800 mm
900 mm
1.100 mm

wedi Fundo slope profile for Fundo Riolito Neo, Plano Linea



1.200 × 30 × 8 mm
1.200 × 30 × 10 mm
1.200 × 30 × 11 mm
1.200 × 30 × 12,5 mm

1.600 × 30 × 8 mm
1.600 × 30 × 10 mm
1.600 × 30 × 11 mm
1.600 × 30 × 12,5 mm

1.800 × 30 × 8 mm
1.800 × 30 × 10 mm
1.800 × 30 × 11 mm
1.800 × 30 × 12,5 mm

wedi Fundo slope profile wall for Fundo Riolito Neo, Plano Linea

	1.200 × 30 × 8 mm	1.600 × 30 × 8 mm	1.800 × 30 × 8 mm
	1.200 × 30 × 10 mm	1.600 × 30 × 10 mm	1.800 × 30 × 10 mm
	1.200 × 30 × 11 mm	1.600 × 30 × 11 mm	1.800 × 30 × 11 mm
	1.200 × 30 × 12,5 mm	1.600 × 30 × 12,5 mm	1.800 × 30 × 12,5 mm

wedi Fundo end profile for Fundo Riolito Neo, Plano Linea

	1.000 × 21 mm
	1.200 × 21 mm

wedi Fundo slope profile for Fundo Riolito, RioLigno

	1.200 × 30 × 8 mm	1.600 × 30 × 8 mm	1.800 × 30 × 8 mm
	1.200 × 30 × 10 mm	1.600 × 30 × 10 mm	1.800 × 30 × 10 mm
	1.200 × 30 × 11 mm	1.600 × 30 × 11 mm	1.800 × 30 × 11 mm
	1.200 × 30 × 12,5 mm	1.600 × 30 × 12,5 mm	1.800 × 30 × 12,5 mm

wedi Fundo slope profile wall for Fundo Riolito, RioLigno

	1.200 × 30 × 8 mm	1.600 × 30 × 8 mm	1.800 × 30 × 8 mm
	1.200 × 30 × 10 mm	1.600 × 30 × 10 mm	1.800 × 30 × 10 mm
	1.200 × 30 × 11 mm	1.600 × 30 × 11 mm	1.800 × 30 × 11 mm
	1.200 × 30 × 12,5 mm	1.600 × 30 × 12,5 mm	1.800 × 30 × 12,5 mm

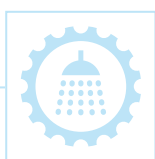

You can plan your shower quickly and easily online with the wedi Shower Configurator. The practical tool guides you through the various possibilities step by step and recommends the right wedi product for your individual initial situation.

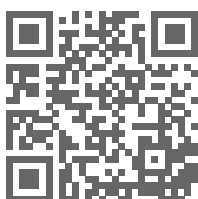

Get started now at: www.wedi.de/en/shower-configurator



wedi design and shape

Design elements for bathroom & wellness areas

wedi design elements in a wide variety of shapes offer unlimited design possibilities. Whether benches of all types, loungers or plumbing and bathroom furniture – the wide variety of designs allow for the creation of stylish and modern bathroom and wellness facilities.

As a seamless alternative to traditional tiling, the wedi Top Line offers panel type design surfaces for walls and matching design surfaces for Fundo shower elements and other wedi functional design elements such as niches or benches for example. The benefits at a glance:

- Modern design, large format and joint-free
- Extensive range, five coordinated colours and textures
- High-quality composite material, coloured all the way through
- Easy-care surfaces, non-slip in the wet area
- Protection against mould and bacteria thanks to a hygienic, anti-bacterial surface
- Quick installation, simultaneously easy and reliable



Design variety at its best

Design elements system configuration

wedi design elements in the form of benches, loungers and bathroom furniture give showers and bathrooms that special touch and impress with both their design and functionality. They can optionally be clad with modern wedi Top design surfaces or individually tiled. All wedi system components are compatible with one another and 100% waterproof in the complete system. For long-lasting reliability with a manufacturer's warranty.

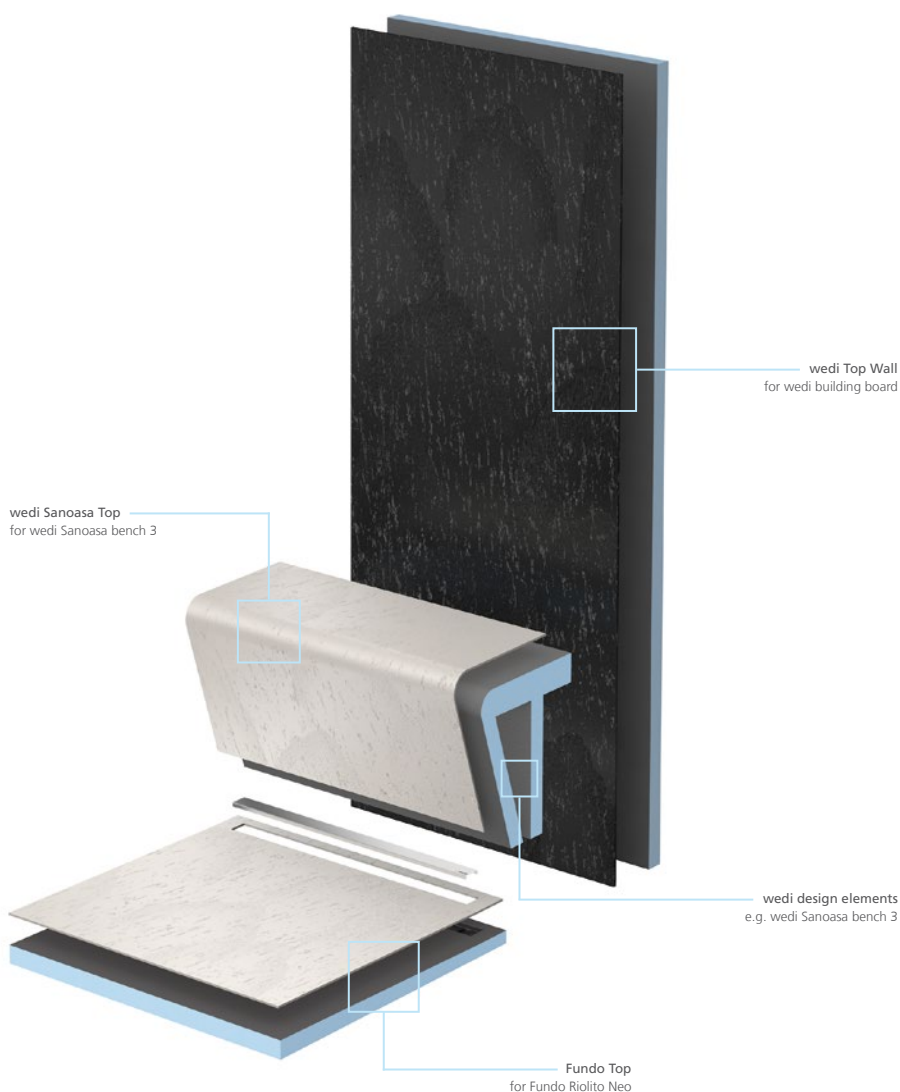



With Hygiene Plus

Protection against mould & bacteria
thanks to anti-bacterial surfaces

Fundo Top® ready-to-use surfaces

The Fundo Top range includes matching design surfaces for the wedi Fundo Primo, Riolito Neo and Plano shower elements that allow you to design an aesthetically pleasing, seamless shower area. The surfaces are available in various designs, are particularly low-maintenance, easy to install and give a pleasant and warm feeling underfoot. In addition to the stone grey, concrete grey, carbon black and sahara beige colour variants in a natural stone look, a pure white colour with a homogeneous surface is also available.



Fundo Top® accessories

There are various Fundo Top accessories to match ready-to-install Fundo Top surfaces: the Fundo Top inlay for the Fundo drain cover 7.1 (point drainage), the channel cover set for wedi Fundo shower systems (line drainage) and the Fundo Top skirting strips for cladding of the visible edges on step-up shower installations. All products are available in matching colours to the Fundo Top shower elements to create a harmonious, attractive shower area.

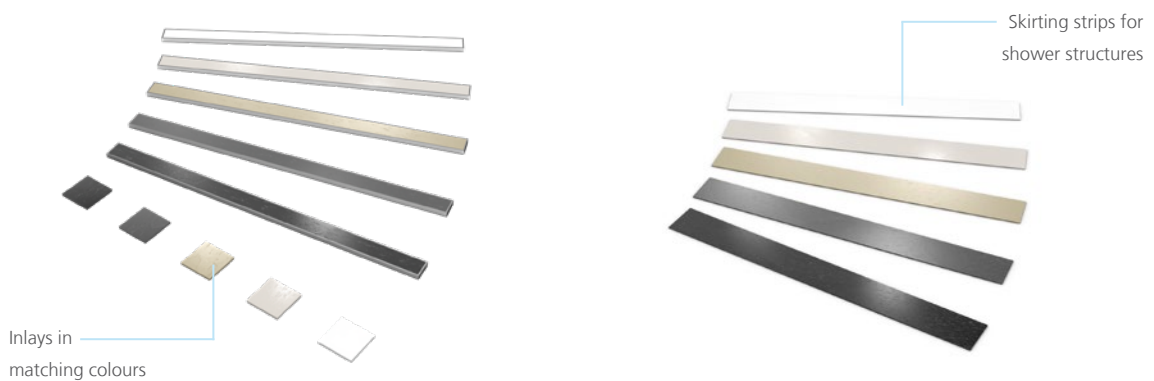

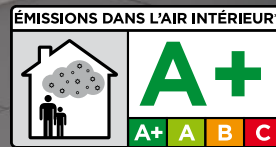

VOC classification

wedi Top Line is very low-emission and non-hazardous

wedi Top® Wall ready-to-use surfaces

The ready-to-install wedi Top Wall design surfaces offer a unique option of seamless thus attractive and low-maintenance wall cladding. They are made from a 6 mm thick high-quality, coloured material and are available in carbon black, concrete grey, stone grey, sahara beige with an aesthetically pleasing natural stone look and in homogeneous pure white to match modern sanitary ware. All colours can be easily cut into desired shapes and organised into characteristic patterns – for an individual surface design.



For seamless wall and surface cladding



wedi Sanoasa® Top ready-to-use surfaces

Anyone who opts for a wedi shower area can fit out not only walls and the shower element but also their bench with the matching wedi Top design surface. The wedi Sanoasa Top makes it possible – tailor-made for the wedi Sanoasa bench 3 and, like all of the functional and design elements in wedi Top Line, available in pure white, stone grey, sahara beige, concrete grey and carbon black.

Specifically designed for
the wedi Sanoasa bench 3



wedi Sanwell® Top ready-to-use surfaces

The wedi Sanwell Top niche was tailor-made for the Sanwell niche and the Sanwell wall element. It allows for joint-free design of shelf and tray elements, e.g. in combination with wedi Top Wall.

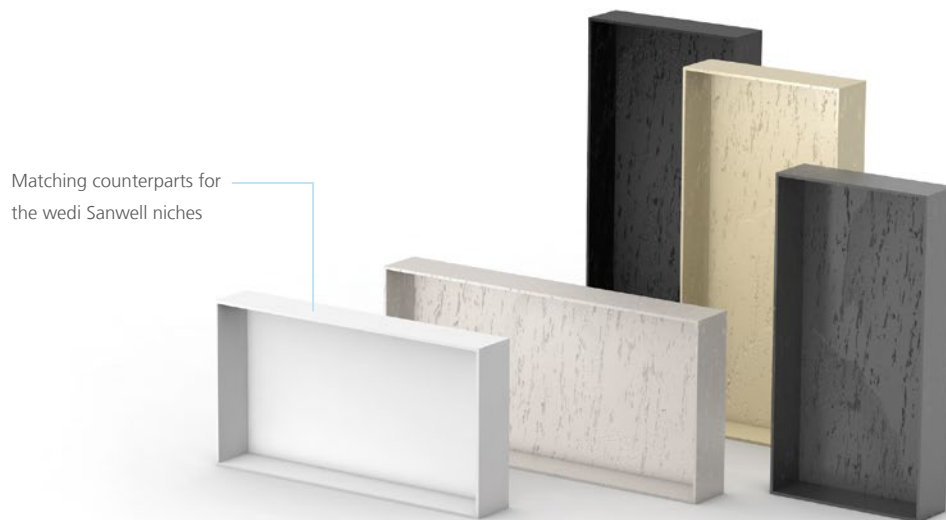

wedi I-Board® Top ready-to-use surfaces

WC retention walls can also be clad quickly and easily with wedi Top design surfaces. Thanks to their antibacterial effect and groutless design they are not only easy to clean but promote hygiene in bathrooms / washrooms.

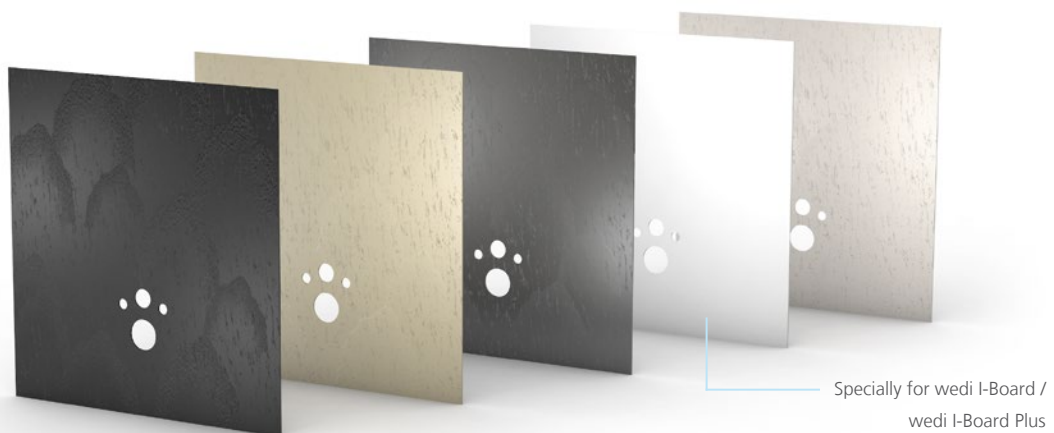

wedi Sanoasa® benches

wedi Sanoasa benches offer plenty of space for relaxation and for comfortable personal care. With a straight, angled or rounded seat edge in a variety of widths or as a floating seat, the right variant is available for every taste and purpose.

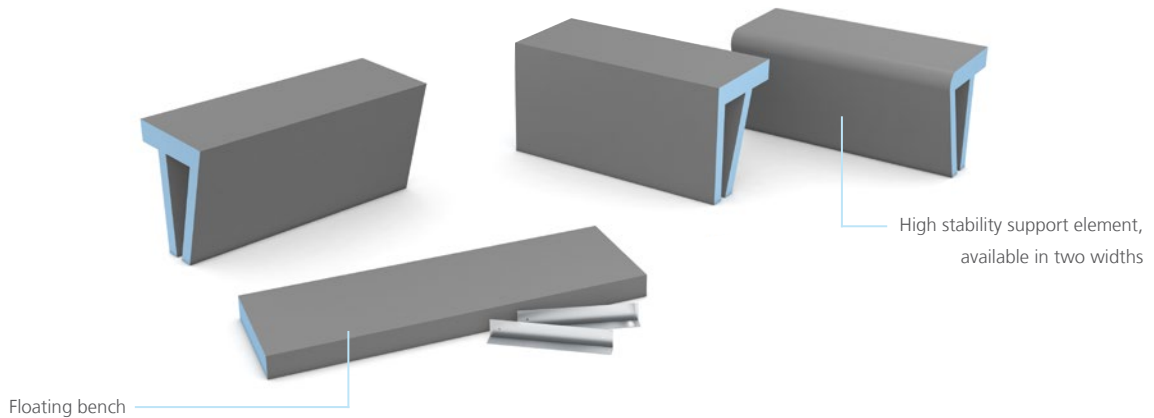

wedi Sanoasa® corner seat element

The floating corner seat element is available in two different sizes and thanks to its triangular, compact shape it is the perfect seating solution for small showers. Installation can be done both on the raw surface as well as later on the finished tiling.

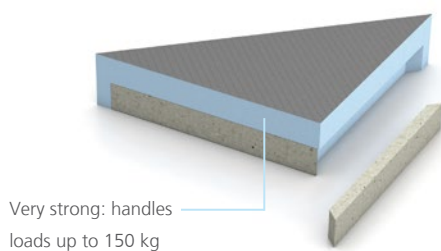

wedi Sanoasa® bench elements

Sanoasa benches in the Comoda and Bellina ranges are available in so many different designs that they enable the construction of almost any seating combination. Whether it be straight, round or corner structures or neat end solutions, they provide a highlight in bathrooms, leisure or wellness facilities.

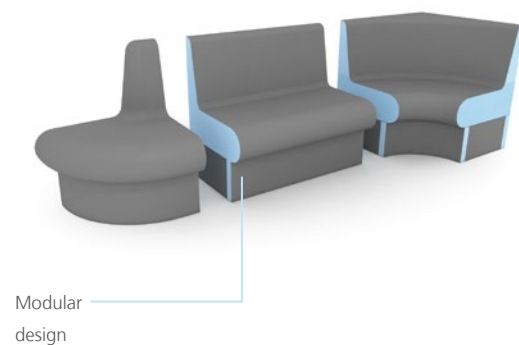



wedi Sanoasa® floating bench

Comfortable seating options in the desired size. The spacious bench in the wedi Sanoasa range is attached on three sides without any substructure thus designed to be floating. The special bit: the length of the tileable bench element can be crafted with millimetre precision between 1.500 and 3.000 mm. A square element is available for the connection of two benches allowing for a corner or a U-shaped seating solution. For even more comfort, a hot water heating system can be integrated into the bench structure. All tools needed for installation are included in the scope of delivery – for a particularly quick and easy installation.

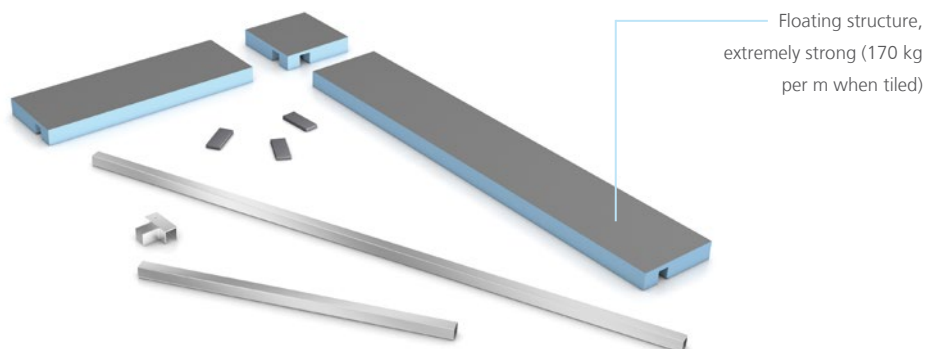

wedi Sanoasa® loungers

wedi Sanoasa loungers stand out due to their distinctive and unique shapes. They are available in five different designs and can be tiled or plastered as desired. All loungers can be ordered with or without integrated heating (either hot water or electric heating).



Distinctive shapes

wedi Sanoasa® Shine loungers

Exclusive wellness loungers with an extravagant design coating. The wedi Sanoasa Shine range offers comfortable loungers in five different shapes for the sophisticated private bathroom or public wellness facility. The high-quality varnish, applied in a multi-layer process, can be produced in approx. 200 UNI colours (RAL) or with a mother-of-pearl effect, makes each lounger a refined designer furniture element. The surfaces are seamless and are therefore particularly hygienic and easy to maintain. The best thing: they can be used as soon as they've been set up – without any installation effort. Thanks to their low weight, they can be moved into the desired position at any time.



approx. **200**
UNI or
mother-of-
pearl colours

wedi Sanbath® floating wash basin with channel

The new floating wash basin is available to order in different widths ranging from 500 mm to 1.300 mm, with various channel lengths of 300/700/800/900 mm. Completing the package, clients have a choice of three channel covers: standard stainless steel, exclusive brushed stainless steel or a tileable to suit.

Floating structure,
load capacity up to 150 kg

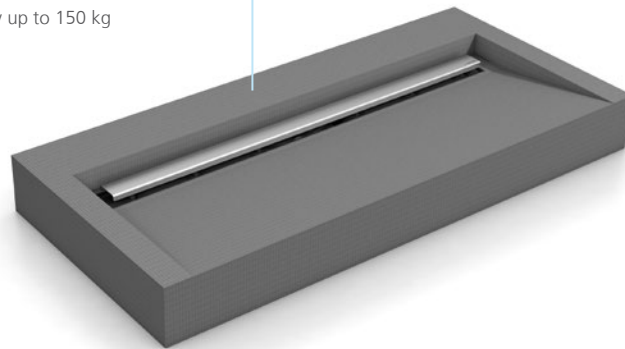

wedi Sanbath® washbasins

The stylish Sanbath Cube and Wave washbasins can be tiled to match the design of the bathroom. They already have all of the necessary recesses for fittings and can therefore be installed easily, quickly and safely.

Prepared for the installation
of fittings and trap

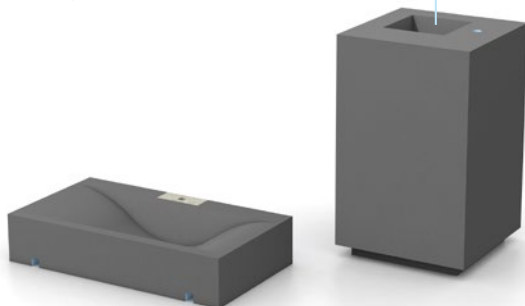

wedi Sanbath® bathtubs

The wedi Sanbath bathtubs in the Cube and Wave ranges stand out with their purist design. They are delivered ready for installation and, directly after positioning and connection, are ready-to be tiled.

Delivered ready
for installation

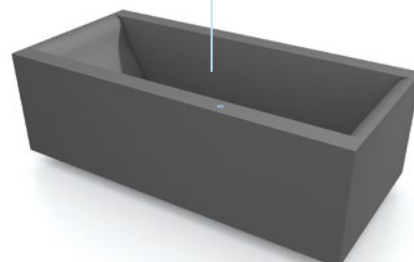

Product overview

Fundo Top for Fundo Primo



square, central
900 × 900 × 6 mm
1.200 × 1.200 × 6 mm

rectangular, central
1.200 × 900 × 6 mm

rectangular, offset
1.200 × 900 × 6 mm
1.400 × 900 × 6 mm
1.600 × 1.000 × 6 mm
1.800 × 900 × 6 mm

Fundo Top for Fundo Plano



square, central
900 × 900 × 6 mm

rectangular, central
1.200 × 900 × 6 mm

rectangular, offset
1.600 × 1.000 × 6 mm

Fundo Top for Fundo Riolito Neo



**rectangular,
close to the wall**
1.200 × 900 × 6 mm
1.600 × 1.000 × 6 mm
1.800 × 900 × 6 mm

Fundo Top Inlay for Fundo drain grid 7.1

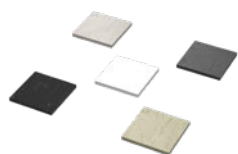

74 × 74 × 6 mm

wedi Fundo channel cover set



790 × 45 × 13 mm

Fundo Top cladding



1.880 × 200 × 6 mm

wedi Top Wall

2.500 × 900 × 6 mm
2.500 × 1.200 × 6 mm

wedi Sanoasa Top for wedi Sanoasa bench 3

1.200 × 380 × 460 mm

wedi Sanwell Top for wedi Sanwell niches

niche 20/40
230 × 430 × 100 mm

niche 30/60
330 × 630 × 100 mm

wedi I-Board Top for wedi I-Board

1.200 × 1.245 × 6 mm

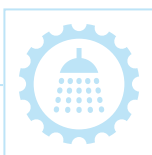

You can plan your shower quickly and easily online with the wedi Shower Configurator. The practical tool guides you through the various possibilities step by step and recommends the right wedi product for your individual initial situation.

www.wedi.de/en/shower-configurator



wedi Sanoasa benches

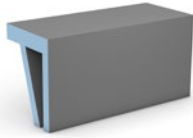

bench 1, straight
 900 × 380 × 454 mm
 1.200 × 380 × 454 mm

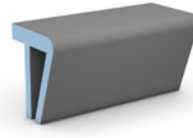

bench 3, rounded
 900 × 380 × 454 mm
 1.200 × 380 × 454 mm



bench 2, angled
 900 × 380 × 454 mm
 1.200 × 380 × 454 mm



bench 4, straight
 1.200 × 380 × 80 mm

wedi Sanoasa corner seat element

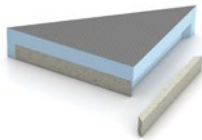

600 × 300 × 100 mm
 800 × 400 × 100 mm

wedi Sanoasa floating bench

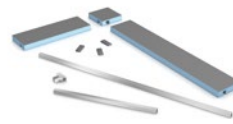

Straight
Corner
U shape
 1.500 – 3.000 mm

wedi Sanoasa Comoda



bench element
 1.000 × 600 × 620 mm
 2.000 × 600 × 620 mm

base element
finish straight
 1.000 × 500 × 250 mm

base element
finish round
 1.000 × 500 × 250 mm

corner bench element
 650 × 650 × 620 mm
 850 × 850 × 620 mm

corner base element
transition straight
 650 × 650 × 250 mm

corner base element
transition rounded
 850 × 850 × 250 mm

end bench element
 600 × 300 × 620 mm
 700 × 600 × 620 mm

end base element
 500 × 200 × 250 mm
 600 × 500 × 250 mm

armrest
 650 × 105 × 870 mm

wedi Sanoasa Bellina

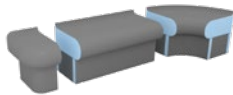

bench element
 1.000 × 486 × 240 mm
 2.000 × 486 × 240 mm

base element
finish straight
 1.000 × 386 × 250 mm

base element
finish round
 1.000 × 425 × 250 mm

corner bench element
 550 × 550 × 240 mm
 736 × 736 × 240 mm

corner base element
transition straight
 550 × 550 × 250 mm

corner base element
transition rounded
 736 × 736 × 250 mm

end bench element
 486 × 300 × 240 mm

end base element
 386 × 200 × 250 mm
 500 × 486 × 250 mm

wedi Sanoasa loungers



Sanoasa lounge chair 1
1.920 x 700 x 672 mm



Sanoasa lounge chair 2
1.442 x 700 x 1.104 mm



Sanoasa lounge chair 3
1.856 x 700 x 764 mm



Sanoasa lounge chair 4
2.014 x 700 x 921 mm



Sanoasa lounge chair 5
1.738 x 700 x 890 mm

wedi Sanoasa Shine loungers *



Sanoasa Shine lounge chair 1
1.920 x 700 x 672 mm



Sanoasa Shine lounge chair 2
1.442 x 700 x 1.104 mm



Sanoasa Shine lounge chair 3
1.856 x 700 x 764 mm



Sanoasa Shine lounge chair 4
2.014 x 700 x 921 mm



Sanoasa Shine lounge chair 5
1.738 x 700 x 890 mm

* Examples only – approx. 200 colours available to order in either plain or mother-of-pearl

wedi Sanbath floating wash basin with channel

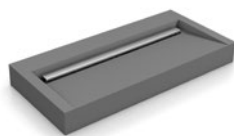

500 – 1.300 x 500 x 120 mm

wedi Sanbath Cube

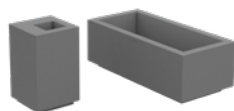

wash stand
570 x 570 x 925 mm

tub
1.800 x 850 x 625 mm

wedi Sanbath Wave

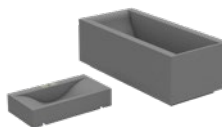

wash basin
1.000 x 550 x 200 mm

tub
1.800 x 850 x 625 mm



wedi building systems

Only the best materials for the best systems

The wedi building board forms the basis for the versatile wedi building systems and is available in a variety of formats: in small or large size for floor and wall applications, as a pre-grooved variant to create curved structures and in the form of functional elements, e.g. for shelf and niche solutions, for the cladding of pipe connections and WC dry wall installations.

- 100 % waterproof in the complete system
- Fully sealed and directly tileable product systems
- Perfect combination of light weight and high stability
- Thermally insulating material to save on energy costs
- Long-lasting protection against moisture and mould
- Quick and easy installation – reliable in the long term

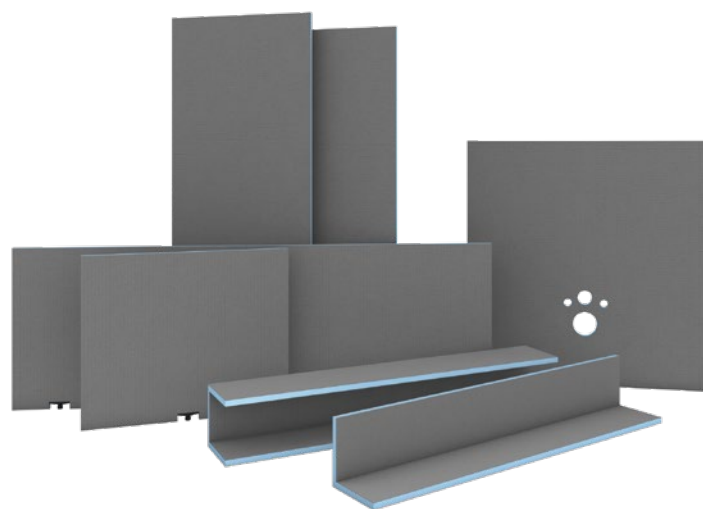

Indispensable under the tiles

Building systems configuration

Functionality and reliability play a key role for all substructures. This is the very reason why tradesmen have been putting their faith in the unique quality of the fully sealed and directly tileable wedi building systems for decades. The base material of wedi building boards is thermally insulating, light and robust all at once, as well as 100 % waterproof in the complete system. For long-lasting reliability with a manufacturer's warranty.

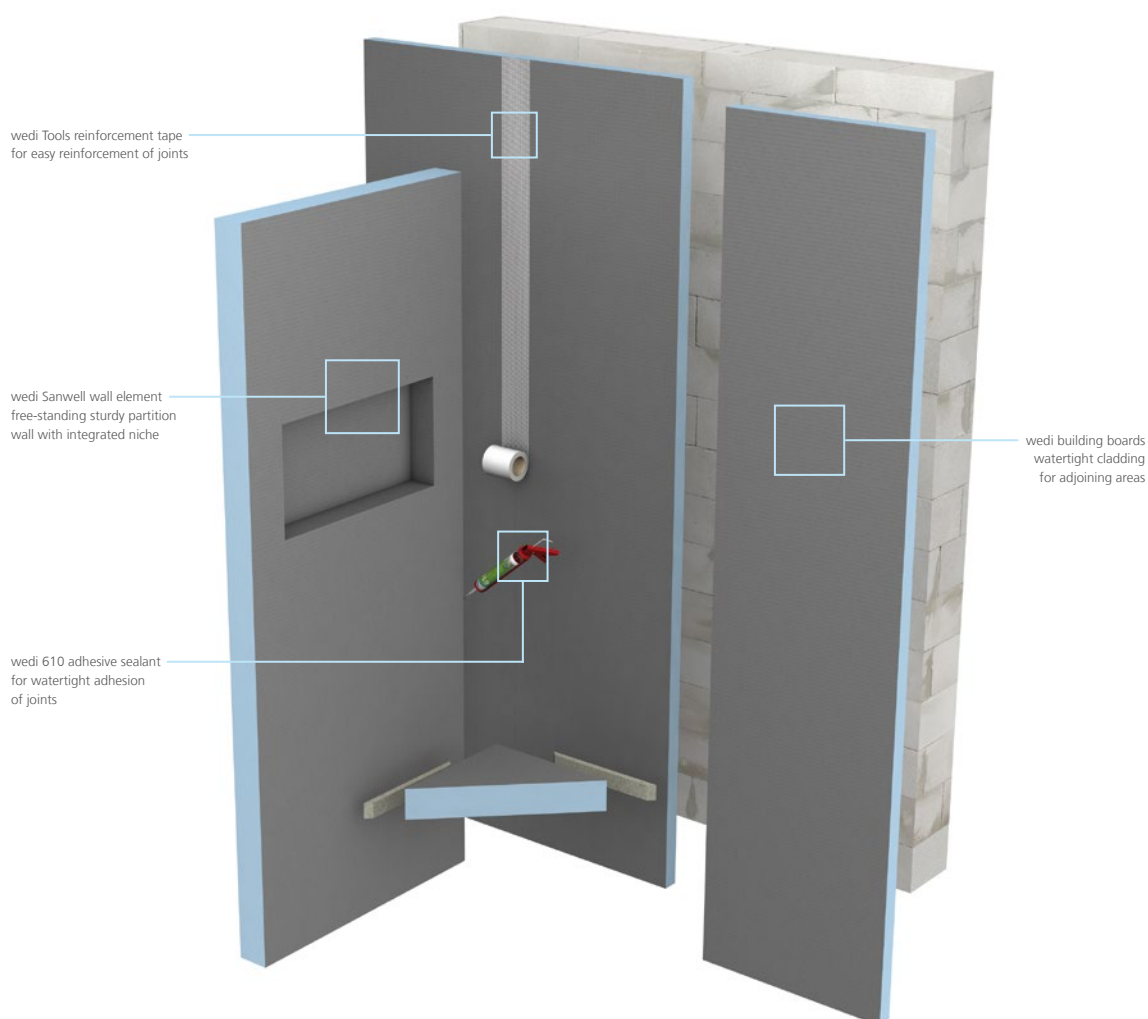



Levelling solution for old wall coverings

wedi building boards in thicknesses of 6 mm can quickly and easily be mounted flush with old tiles creating a neat, even surface. They are also often used as packing/levelling strips under mosaic accent strips and are also very helpful on walls with large format tiling.

Products used

- 1 wedi 320 ▫ for full-surface bonding of building boards to the substrate
- 2 wedi building board ▫ thickness 6 mm, for designing wall solutions
- 3 wedi 610 ▫ adhesive and sealant for the watertight adhesion of joints
- 4 wedi Tools reinforcement tape ▫ for reinforcing joints

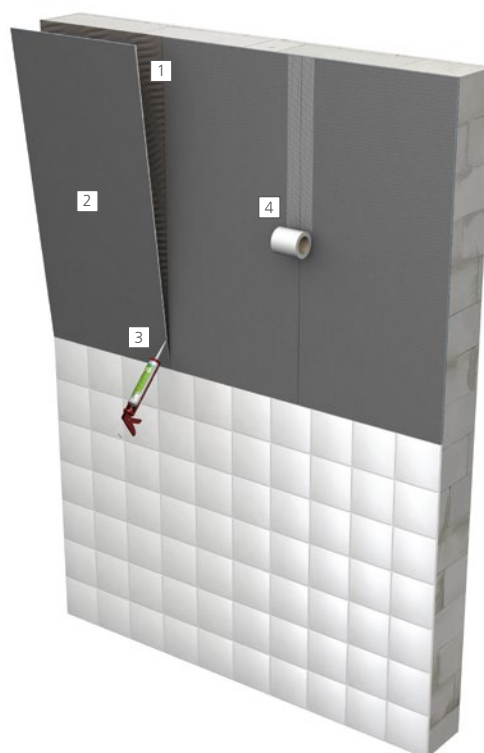

Transition solution for plasterboard walls

wedi building boards in the 12,5 mm thickness connect flush and precisely to plasterboard panels and thus create a practical continuation as sealing in the wet areas of bathrooms.

Products used

- 1 wedi building board ▫ thickness 12,5 mm, for designing wall and partition wall solutions
- 2 wedi Tools reinforcement tape ▫ for reinforcing joints
- 3 wedi 610 ▫ adhesive and sealant for the watertight adhesion of joints and for direct bonding wedi building boards onto stud frames
- 4 wedi Fundo sealing set ▫ for sealing of the perimeter of Fundo shower elements when connecting to adjacent surfaces
- 5 Fundo Primo ▫ shower element, in this case with central point drainage



Levelling solution for uneven walls

wedi building boards in 20 mm thickness, in combination with wedi Tools metal dowels, turn old surfaces which are not or are only partially load-bearing into a load-bearing, even surface – easily, quickly and cost-effectively.

Products used

- 1 [wedi 360](#) ▀ middle bed mortar for thicker adhesive beds
- 2 [wedi building board](#) ▀ thickness 20 mm, for construction of wall solutions on uneven surfaces
- 3 [wedi Tools metal dowels](#) ▀ for affixing building boards to walls
- 4 [wedi Tools sealing tape](#) ▀ for reliable sealing of intersections and butt joints
- 5 [wedi 520](#) ▀ flexible sealant for the sealing of wedi Tools sealing tapes (fleece tapes)

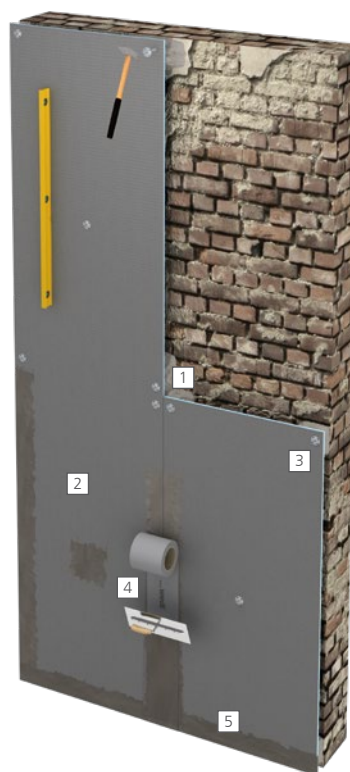

Design solution for round shapes

The wedi Construct building board offers countless possibilities in the design of individual shapes. Whether it's narrow radii or semi-circular solutions, the factory-cut longitudinal and transverse incisions make it possible.

Products used

- 1 [wedi building board](#) ▀ for constructing individual, tailor-made solutions
- 2 [wedi 610](#) ▀ adhesive and sealant for the watertight adhesion of joints
- 3 [wedi Construct](#) ▀ shapeable building board for individual configuration
- 4 [wedi Tools reinforcement tape](#) ▀ for reinforcing joints
- 5 [wedi Subliner Dry & Flex](#) ▀ crack-bridging sealing and decoupling membrane
- [wedi 520](#) ▀ flexible sealant for the sealing of wedi Tools sealing tapes (fleece tapes)
- [wedi Tools sealing tape](#) ▀ for reliable sealing of intersections and butt joints

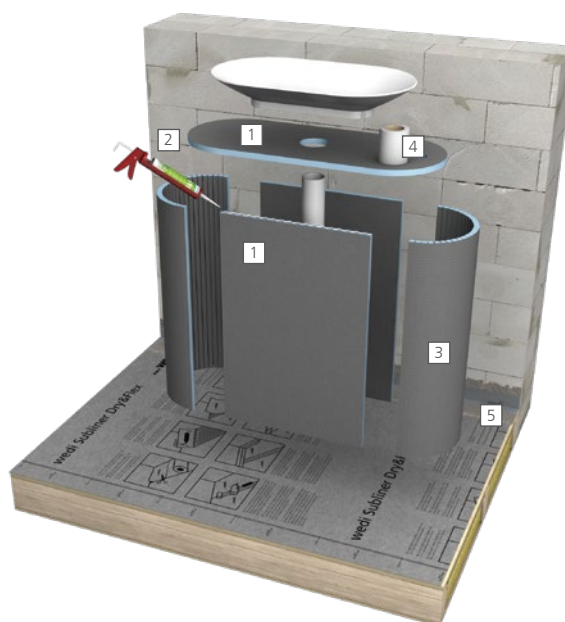

wedi building board

wedi building boards form the basis for all wedi system solutions. They are 100 % waterproof, extremely robust and available in numerous formats. All of them can be cut to the desired size and shape without any loss of function or forfeiture of the guarantee and offer thermal insulation and waterproofing at the same time. Thanks to their versatility they make almost anything possible; from wall/floor cladding, through customised individual items and solutions such as tailor-made washstands or partition walls for example, to the complete floor to ceiling system – a whole bathroom from a single source.

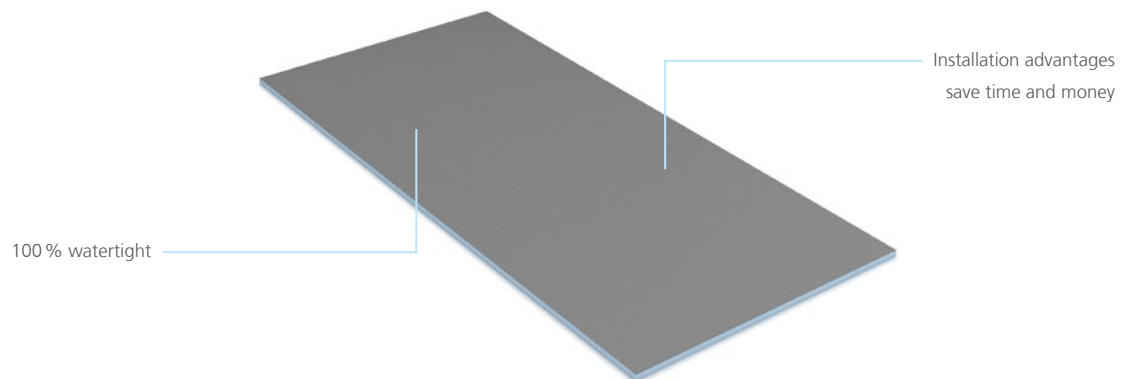

wedi XL and XXL building boards

Large format wedi building boards are particularly notable due to their extraordinary widths of up to 1.20 m. As a result, they are not only ideal for use as free-standing walls, they also reduce the number of joints therefore simplify the installation enormously. The XL and XXL formats offer the same benefits as the standard wedi building boards and despite their size, due to their low weights they are easy to handle.

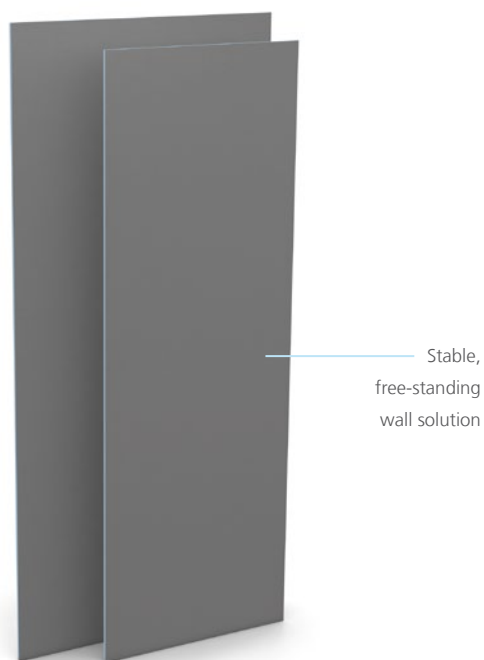

wedi Vapor 85 building board

wedi Vapor 85 building board is an approved, panel type sealing system with structural vapour barrier properties. Owing to its high Sd value of 92 m, it is perfect for applications in wet areas with high humidity for the protection of the structure, e.g. for steam showers, spa & wellness facilities, etc.

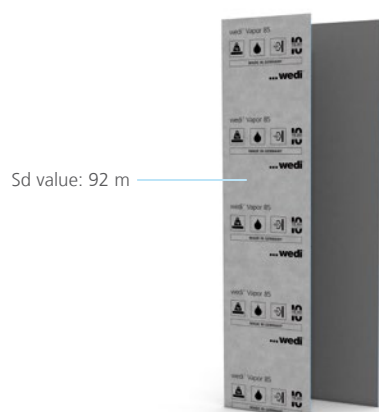

wedi Vapor building board

wedi Vapor is a building board which is used as a vapour barrier for increased requirements. Owing to its very high Sd value of 283 m, it is perfect for extremely demanding applications in areas with constant high humidity for the protection of the structure, e.g. at public swimming pools.

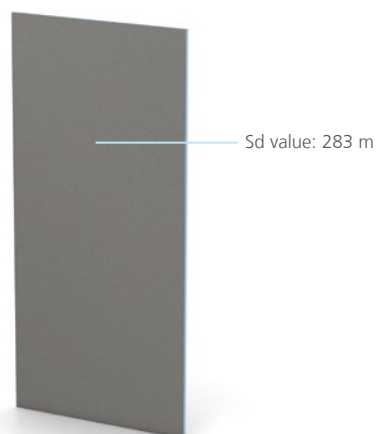

wedi Construct® building board

The wedi Construct offers countless possibilities in the design of individual shapes. Regardless of whether it is narrow radii or semi-circular solutions, thanks to its factory-cut longitudinal and traverse sections, the Construct building board gives free rein to every idea.

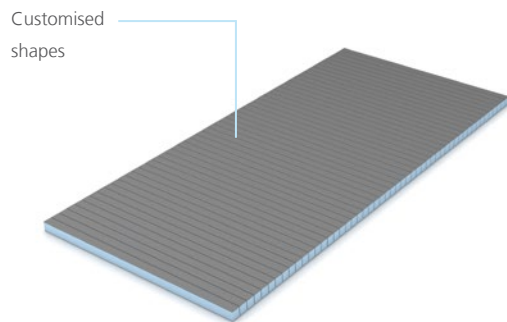

wedi PreLine building board

wedi PreLine is a fully prepared building board element with factory-cut recesses for the easy installation of a hot water heating system. The strong insulation properties of the material reflect the heat back into the room and ensure balanced heat distribution.

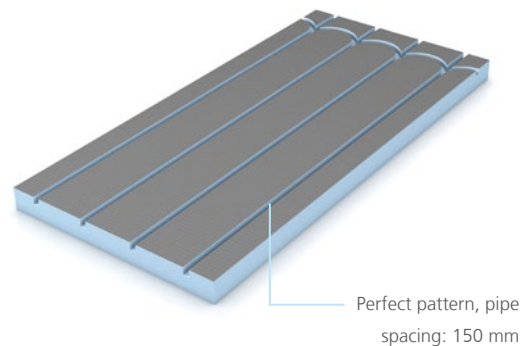

wedi Mensolo® L / U angle unit

The practical Mensolo prefabricated elements in L and U shapes are extremely versatile, for example as pipe cladding or a shelf solution. Subsequent surface design can be done either with wedi Top Wall, with tiles or plaster.

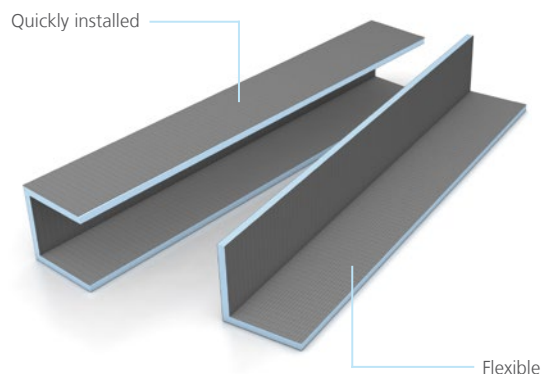

wedi Bathboard® bath cladding

The prefabricated wedi Bathboard bath cladding with a thickness of 20 mm can be used for almost every bath format. Thanks to the height-adjustable feet, uneven areas of up to 10 cm can be safely levelled during the installation.

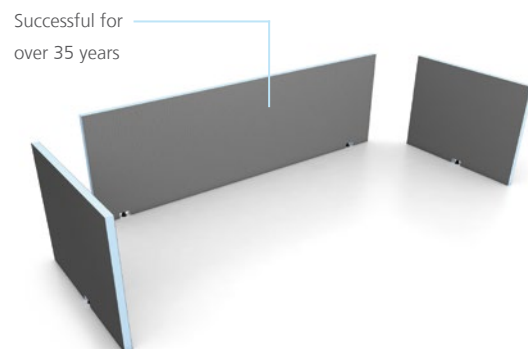



wedi I-Board® and wedi I-Board® Plus WC dry wall installation cladding

wedi I-Board and wedi I-Board Plus are ready-to-use installation boards for cladding of wall-hung toilets. Despite their low weight they are extremely robust and have a very high load-bearing capacity so can be utilised as an additional ledge surface in the toilet area. Furthermore, thanks to its width of 1.200 mm, it can be easily adapted to practically any requirements and, despite its low weight, it is extremely stable and resilient. Thanks to the reinforcement panel integrated in the factory, wedi I-Board Plus can be plastered (plaster thickness ≥ 3 mm) or tiled with mosaic (from 2×2 cm).

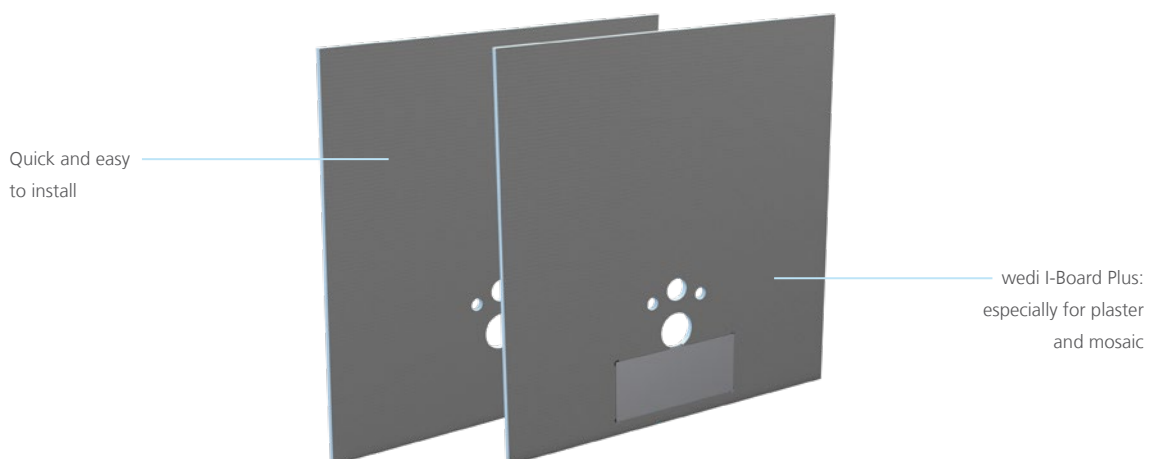



wedi Sanwell® niches

wedi Sanwell niches are perfect, aesthetically pleasing storage solutions for bathrooms or showers. They provide an easy-to-maintain storage space for shower accessories or decorative elements without compromising on floor space. The available range of sizes and formats interlock with all other wedi elements.

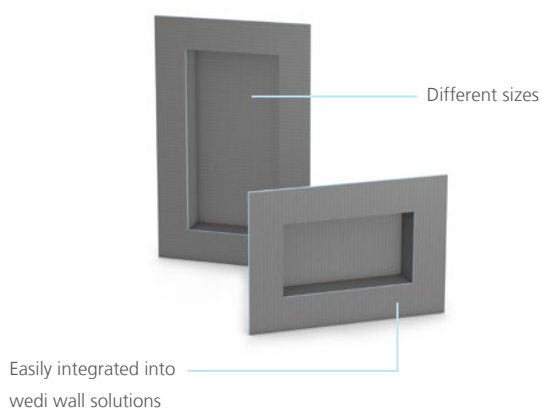

wedi Sanwell® wall element

The Sanwell wall element with a width of 900 mm or 1.200 mm incl. niche is perfect for use as a free-standing wall. Both the size of the wall itself and the size of the integrated niche is customisable to suit and because it is made from waterproof extruded polystyrene rigid foam, it is very easy to handle and fit. Laborious construction and sealing is no longer required.

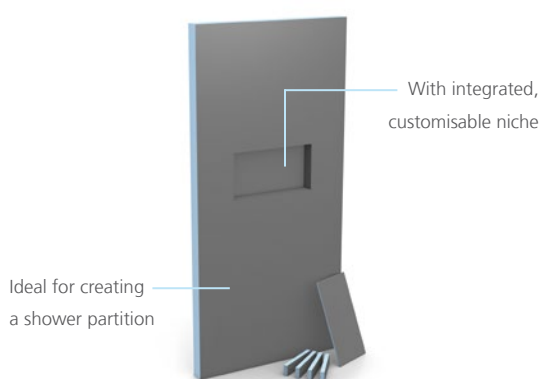

Fundo design showers

Extravagant wall elements in round or spiral shapes combined with appropriate shower elements are perfect as free-standing showers in spacious rooms. They are optionally available with or without supply channels to suit all requirements.

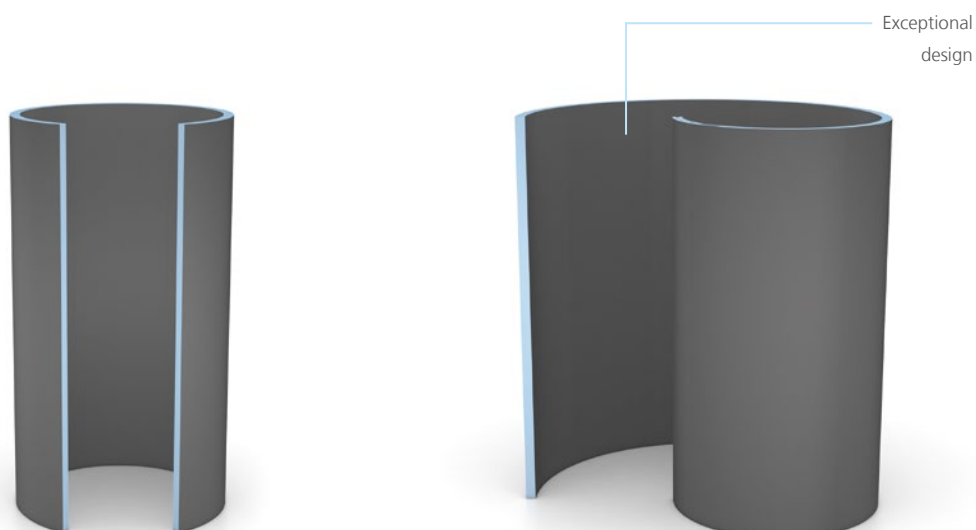

Product overview

wedi building board

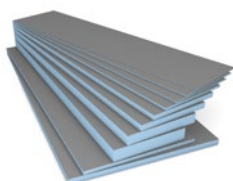

1.250 × 600 × 4 mm	2.500 × 600 × 30 mm	2.600 × 600 × 10 mm
1.250 × 600 × 6 mm	2.500 × 600 × 40 mm	2.600 × 600 × 20 mm
1.250 × 600 × 10 mm	2.500 × 600 × 50 mm	2.600 × 600 × 30 mm
2.500 × 600 × 4 mm	2.500 × 600 × 60 mm	2.600 × 600 × 40 mm
2.500 × 600 × 6 mm	2.500 × 600 × 80 mm	2.600 × 600 × 50 mm
2.500 × 600 × 10 mm	2.500 × 600 × 100 mm	
2.500 × 600 × 12,5 mm	2.500 × 625 × 12,5 mm	
2.500 × 600 × 20 mm		

wedi XL building board

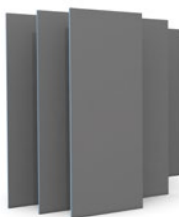

2.500 × 900 × 12,5 mm
2.500 × 900 × 20 mm
2.500 × 900 × 30 mm
2.500 × 900 × 50 mm

wedi XXL building board



2.500 × 1.200 × 10 mm
2.500 × 1.200 × 20 mm
2.500 × 1.200 × 30 mm
2.500 × 1.200 × 50 mm
2.600 × 1.200 × 10 mm
2.600 × 1.200 × 12,5 mm
2.600 × 1.200 × 20 mm

wedi Vapor 85 building board



2.500 × 600 × 12,5 mm
2.500 × 600 × 20 mm
2.500 × 900 × 12,5 mm
2.500 × 900 × 20 mm

wedi Vapor building board



2.500 × 600 × 14 mm
2.500 × 600 × 21.5 mm
2.500 × 600 × 51.5 mm

wedi Construct building board

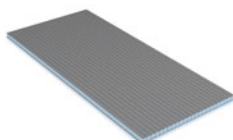

lengthwise
2.500 × 600 × 20 mm
2.500 × 600 × 30 mm
2.500 × 600 × 50 mm

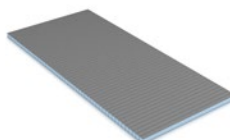

widthwise
2.500 × 600 × 20 mm
2.500 × 600 × 30 mm
2.500 × 600 × 50 mm

wedi PreLine building board

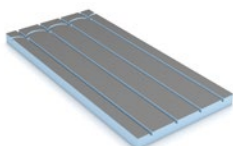

1.240 × 600 × 30 mm
1.240 × 600 × 40 mm
1.240 × 600 × 50 mm
1.240 × 600 × 60 mm

wedi Mensolo L/U angle unit

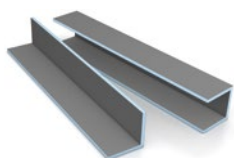
**L angle unit**

2.500 × 150 × 150 mm
 2.500 × 200 × 200 mm
 2.500 × 200 × 400 mm
 2.500 × 300 × 300 mm

2.600 × 150 × 150 mm
 2.600 × 200 × 200 mm
 2.600 × 200 × 400 mm
 2.600 × 300 × 300 mm

U angle unit

2.600 × 200 × 200 mm
 2.600 × 300 × 150 mm

wedi Bathboard bath and shower tray cladding

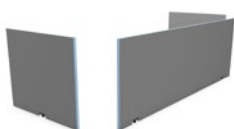
**bath cladding
side panel**

1.800 × 600 × 20 mm
 2.100 × 600 × 20 mm

head piece

770 × 600 × 20 mm

shower tray cladding

900 × 200 × 20 mm
 900 × 300 × 20 mm

wedi I-Board WC dry wall installation cladding



1.200 × 1.245 × 20 mm

wedi I-Board Plus WC dry wall installation cladding



1.200 × 1.245 × 20 mm

wedi Sanwell niche

**niche 20/40**

454 × 654 × 112,5 mm
 454 × 654 × 82,5 mm

niche 30/60

554 × 854 × 112,5 mm
 554 × 854 × 82,5 mm

wedi Sanwell wall element

**XL, with niche 60/30**

2.500 × 900 × 100 mm

XXL, with niche 60/30

2.500 × 1.200 × 100 mm

Fundo Trollo

**wall element**

1.100 × 2.015 mm

extension collar wall

1.100 × 500 mm

**Fundo Trollo libero
wall element**

1.154 × 1.100 × 2.015 mm

extension collar wall

1.154 × 1.100 × 500 mm

Fundo Nautilo

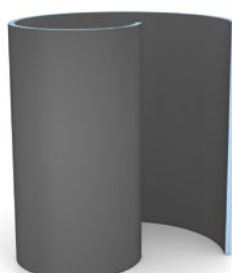
**wall element**

1.850 × 1.475 × 2.015 mm

extension collar wall

1.850 × 1.475 × 500 mm

**Fundo Nautilo libero
wall element**

1.850 × 1.475 × 2.015 mm

extension collar wall

1.850 × 1.529 × 500 mm



wedi
610

wedi
610

wedi

wedi
620

wedi

wedi

wedi

wedi Subliner

wedi system accessories

For simple, reliable and safe sealing

Quick, high-quality with reliability – the versatile range of accessories from wedi offers certified components of wedi sealing systems as well as practical system aids for adhesion and installation. From the tried and tested wedi 610 adhesive sealant through fleece-backed sealing membranes and corners to the comprehensive wedi Fundo sealing set for all professional connections and joints in the shower.

- All products in one place
- Perfectly coordinated
- Quick and easy to use
- For a reliable result – tested and approved



First class technology

Accessory product system configuration

The extensive range of system accessories with all of the necessary components for sealing, adhesion and installation rounds out the wedi portfolio. Every product is perfectly coordinated and comes from a single source – for quick and easy installation, as well as long-term reliability with approval and a manufacturer's warranty.

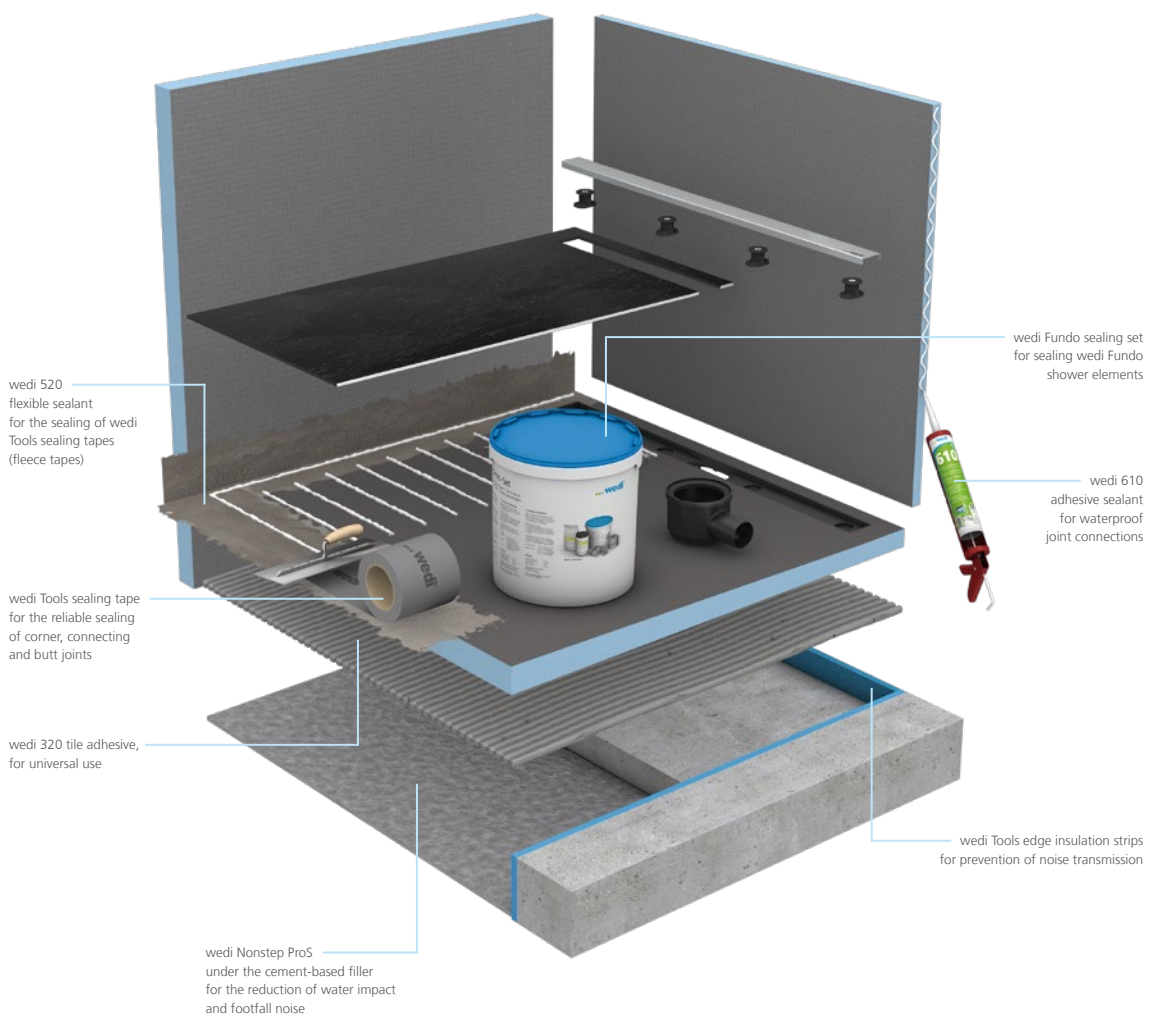



Sealing in the wedi system – everything from a single source

The right solution for every requirement

Sealing is a key theme in the building and renovation of bathrooms, in particular because of the interaction of various trades. That's why wedi has developed its own sealing concept. The sealing details include edge joints on walls and floors, expansion and contraction joints, transitions to the shower area and all types of intersections. wedi offers the right sealing system for every purpose. Tested, approved, perfectly coordinated and quick and easy to implement.



Types of surface sealing

No.	Area	Water impact (in accordance with DIN 18534-1)	Waterproofing type	Recommended sealing systems
1	Wall surfaces in showers	moderate (W1-I)	panel type seal	wedi building boards
			panel type seal	wedi Vapor 85
			liquid seal	wedi 520 flexible sealants
			sheet type seal	wedi Subliner Dry
			sheet type seal	wedi Subliner Dry & Flex
2	Partition shower wall	moderate (W1-I)	panel type seal	wedi building board, Partition wall from 50 mm
3	Flush-to-floor showers	high (W2-I)	panel type seal as a shower element with drain	wedi Fundo shower elements
4	Wall surfaces above bathtubs	moderate (W1-I)	panel type seal	wedi building boards
			panel type seal	wedi Vapor 85
			liquid seal	wedi 520 flexible sealants
			sheet type seal	wedi Subliner Dry
			sheet type seal	wedi Subliner Dry & Flex
5	Floors in rooms without high exposure to water from the shower area	moderate (W1-I)	panel type seal	wedi building boards
			liquid seal	wedi 520 flexible sealants
			sheet type seal	wedi Subliner Dry
			sheet type seal	wedi Subliner Dry & Flex
	Floors in rooms with flush-to-floor showers	high (W2-I)	panel type seal	wedi building boards
			liquid seal	wedi 520 flexible sealants
			sheet type seal	wedi Subliner Dry
			sheet type seal	wedi Subliner Dry & Flex

National standards, data sheets and guidelines should be observed

Components of the wedi sealing systems

wedi sealing system	System components
wedi building boards	wedi 610 adhesive sealant wedi 520 flexible sealant wedi 320 universal tile adhesive wedi Tools sealing tape, corners and sealing gaiters
wedi Vapor 85	wedi 620 sealant wedi 320 universal tile adhesive wedi Tools sealing tape, corners and sealing gaiters
wedi Fundo shower elements	wedi 610 adhesive sealant wedi 520 flexible sealant wedi 320 universal tile adhesive wedi Tools sealing tape, corners and sealing gaiters wedi Fundo sealing set (contains: wedi 520 flexible sealant, wedi Tools sealing tape, corners; designed for sealing of a wedi Fundo shower element)
wedi 520 flexible sealant	wedi 320 universal tile adhesive wedi Tools sealing tape, corners and sealing gaiters
wedi Subliner Dry sealing membrane wedi Subliner Dry & Flex decoupling membrane	wedi 620 sealant wedi 520 flexible sealant wedi 320 universal tile adhesive wedi Tools sealing tape, corners and sealing gaiters
Accessories	wedi Tools butyl bathtub sealing tape wedi Tools cut-resistant tape wedi Tools wall sealing set (contains: wedi Subliner Dry sealing membrane, wedi Tools sealing tape, sealing gaiters, wedi 520 flexible sealant)

wedi 320 tile adhesive

The universal wedi 320 thin-bed mortar based on a hydraulic binding agent is ideal for fixing and laying wedi building boards as well as wall and floor tiles in interior areas.



Waterproof and
for universal use

wedi 360 flexible medium-bed mortar

Highly polymer-modified, hydraulic and quick-drying middle bed mortar for wedi building boards as well as wall and floor coverings. Perfect for 5 – 20 mm mortar bed thickness.



Ideally suited
for indoors

wedi 610® adhesive sealant

As a versatile single-component adhesive sealant, wedi 610 is ideal for easy, reliable and waterproof joint connection between wedi building boards in just one easy step. The combination of wedi building boards and wedi 610 has ETA approval and a general building authority test certificate for highly stressed areas.



Free from solvents,
silicone and PCP

wedi 620 sealant

wedi Tools sealing tapes, sealing corners and sealing gaiters can be bonded and fully waterproofed with wedi 620. It is also used for sealing of wedi Vapor 85 with pre-integrated vapour membrane barrier applied in the factory and of joint areas of the wedi Subliner Dry and wedi Subliner Dry & Flex sealing and decoupling membranes.



Indispensable
in combination
with wedi Vapor 85

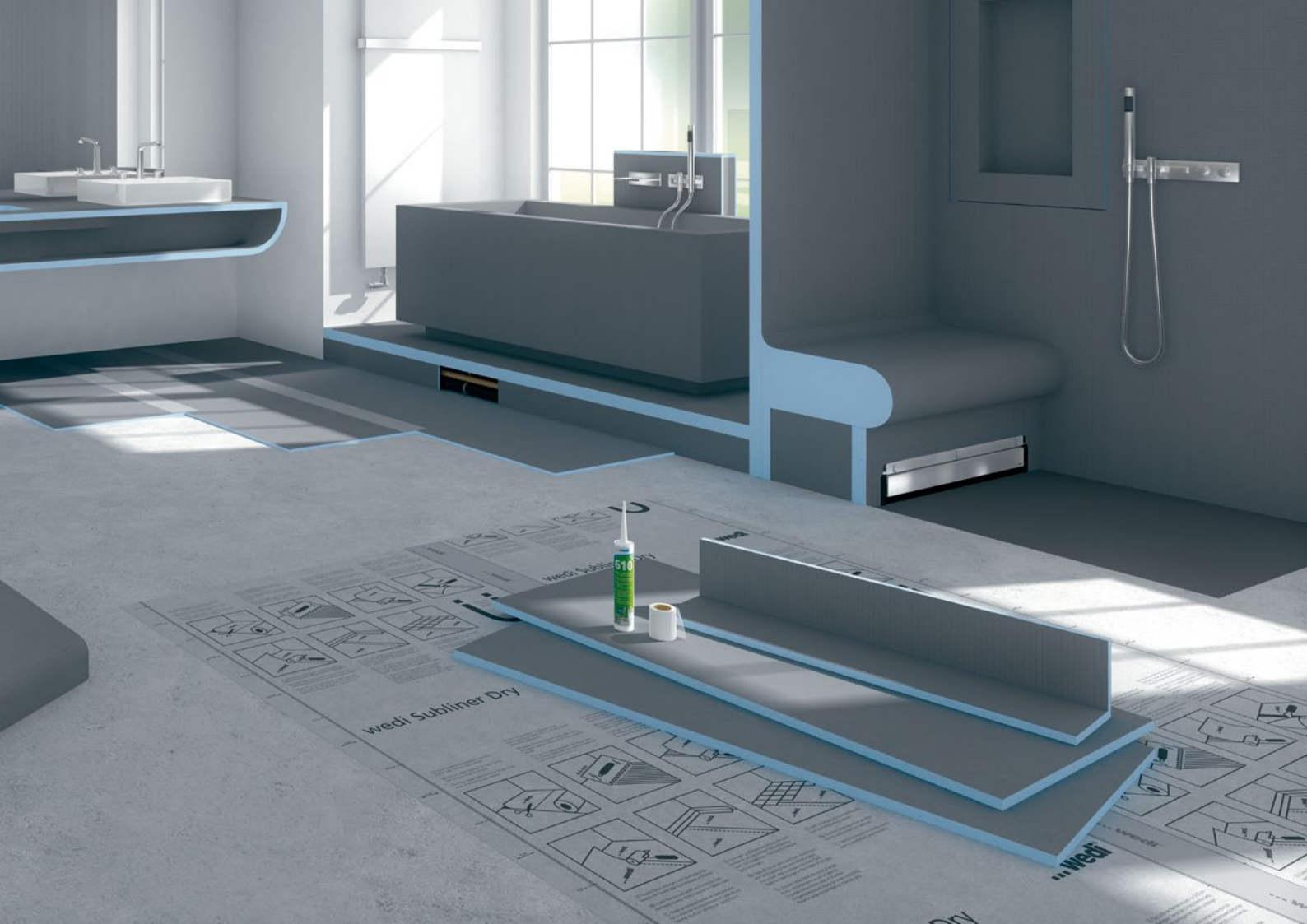

wedi 520 sealant

The flexible and 2-component wedi 520 sealant bridges cracks and guarantees the highest degree of reliability should any surface cracks subsequently develop. Ideal for the sealing of wedi Tools sealing tapes (fleece tapes) and transition joints between wedi and non-wedi surfaces in wet areas.



wedi Fundo® sealing set

The wedi Fundo sealing set consists of wedi 520 sealant, wedi Tools sealing tape and wedi Tools sealing corners, and is especially suitable for waterproof connection of Fundo shower elements to other materials outside of the system, such as floor screed or plasterboard, as well as adjoining wedi sealing systems.



wedi Tools® wall sealing set

The wedi Tools wall sealing set provides all of the components for reliable and long-lasting sealing of the wall surfaces in the shower area. It includes the waterproof and crack-bridging wedi Subliner Dry sealing membrane, the wedi Tools sealing tape for flexible joint sealing, the wedi Tools sealing collars in various sizes for sealing of pipe penetrations and the wedi 520 flexible two-component sealant.



wedi Tools® sealing tape and corners

wedi Tools sealing tape and sealing corners are suitable for reliable sealing of corner, connecting and butt joints. They are made from TPE (thermoplastic elastomers) coated with polypropylene fleece and have very good adhesion properties.

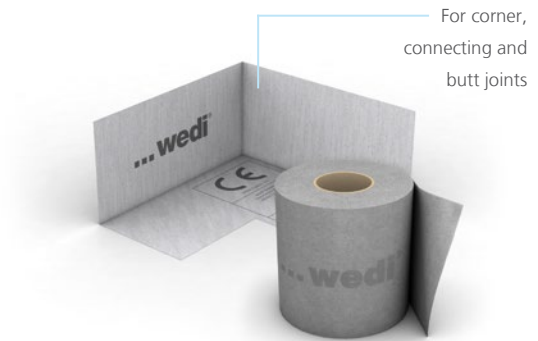

wedi Tools® slope sealing

The three-dimensional sealing corners made from TPE-coated polypropylene fleece are ideal for sealing the joints between the wall and floor and are designed with the different slope gradients of the Fundo Riolito and Riolito Neo shower elements in mind.

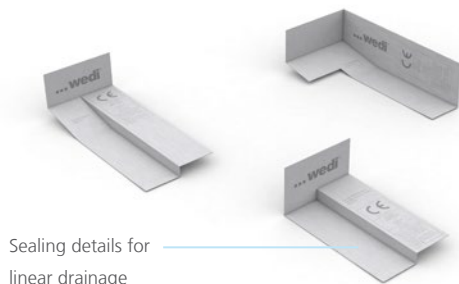

wedi Tools® cut-resistant tape

wedi Tools cut-resistant tape is used in particular for wall/wall and wall/floor joints, as well as for expansion and contraction joints in the floor. The robust material prevents damage to the sealing when cutting out elastic sealants. With a thickness of just 0.90 mm, it can be perfectly integrated into every wedi sealing system.



wedi Tools® sealing gaiters

The flexible and fleece laminated wedi sealing gaiters are suitable for the sealing of pipe penetrations under ceramic flooring in shower and wet rooms. Available for pipe diameters of 10 – 24 mm, 35 – 50 mm, 50 – 75 mm and 90 – 125 mm, they offer a reliable sealing solution for a wide variety of penetration sizes. In addition, wedi offers another sealing gaiter for system-compatible sealing of separate floor drains.

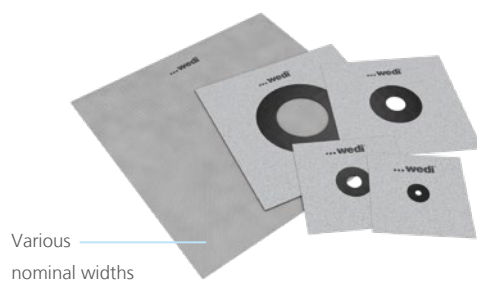

wedi Tools® butyl bathtub sealing tape

The fleece laminated wedi Tools tub sealing tape consists of a TPE-coated polypropylene fleece equipped with butyl strips. It has good adhesion properties and is suitable for secure sealing of tubs and shower trays made from steel enamel, acrylic or similar materials. It is optionally available in a set with the self-adhesive decoupling strip which creates tension compensation between the tub and the adjoining wall.

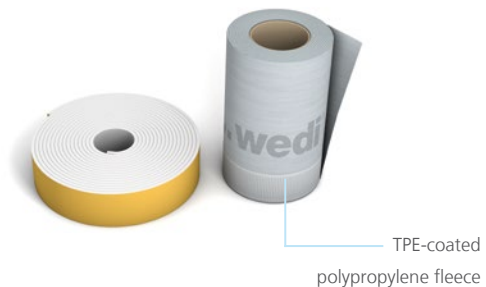



wedi Subliner® Dry & Flex

The flexible, crack-bridging wedi Subliner Dry & Flex sealing and decoupling membrane is made from a highly tear-resistant polyethylene film and is suitable for fast sealing for projects with fixed completion dates in conjunction with ceramic tiles and slabs, as well as with natural stone cladding for walls. The special membrane provides improved tension compensation when sudden temperature changes occur. It is tested and approved for areas of application up to A and C (in accordance with DIN 18534, W2-I).

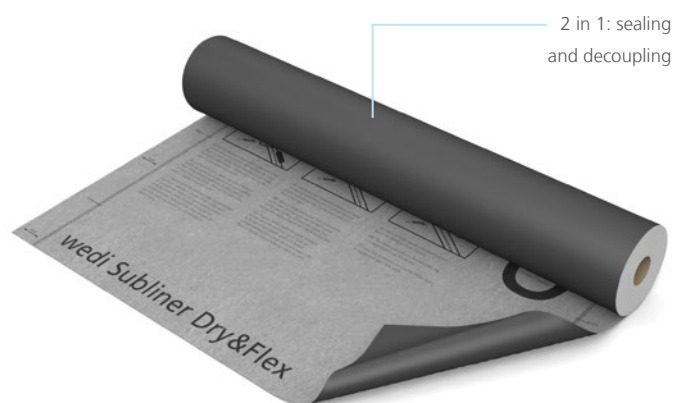

2 in 1: sealing
and decoupling

wedi Subliner® Dry

wedi Subliner Dry is a thin-layered, crack-bridging sealing membrane made from highly tear-resistant polyethylene film which, thanks to its special layer of fleeced material on both sides, provides the optimum anchorage for tile-laying materials. Perfect for combining with the wedi system components, e.g. wedi Tools sealing tape and wedi 520. Tested and approved for areas of application up to A and C (in accordance with DIN 18534, W2-I).



wedi Subliner® Flex

The wedi Subliner Flex crack-bridging decoupling membrane for wall and floor surfaces in indoor areas is made from a robust reinforcement fabric with a special fleece layer on each side that ensures excellent adhesion of tile setting compounds.



wedi Tools® reinforcement tape

The self-adhesive wedi Tools reinforcement tape is a special fabric tape for fixing or bridging of building board joint edges.

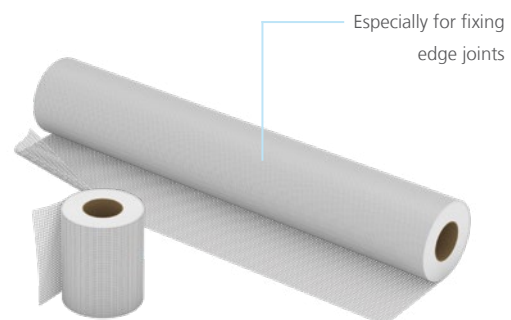

wedi Nonstep® ProS

Improved sound insulation with a lower installation height. wedi Nonstep ProS is a high-quality sound insulation fleece which is used under wedi Fundo shower elements to significantly reduce water impact and footstep noises. The Nonstep ProS not only meets the minimum requirements (DIN 4109) but has also been successfully tested in the wedi system for compliance with the increased sound insulation requirements (VDI 4100). The soft and flexible material easily covers any unevenness in the floor, is moisture and rot-resistant, prevents mould growth and is recyclable.

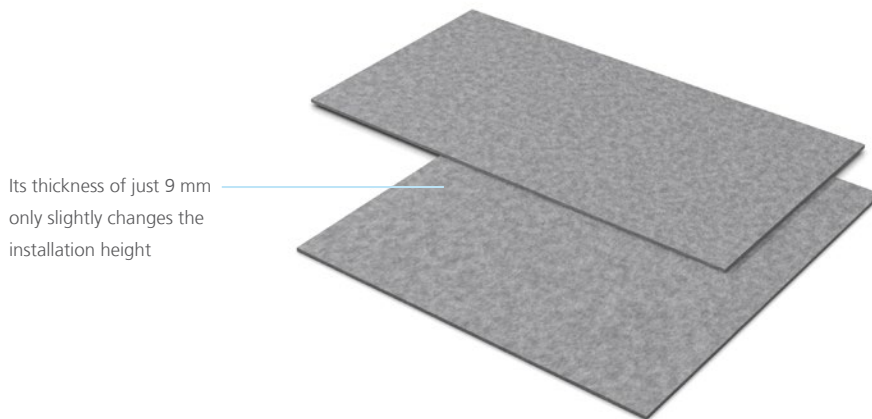

wedi Nonstep® Plan

wedi Nonstep Plan impact sound deadening is a thin-layered rubber granulate mat with a flexible, mineral coating which can be used for decoupling under ceramic floor coverings, laminate or ready-to-lay parquet.

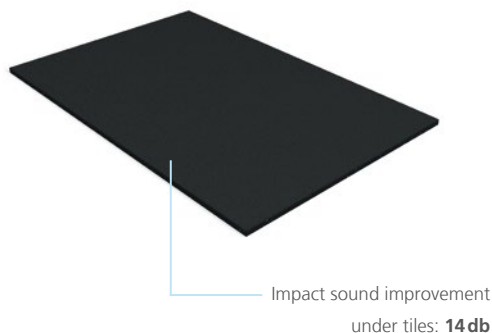

wedi Nonstep® Plus

wedi Nonstep Plus impact sound deadening consists of a 6 mm wedi building board bonded in the factory to a 5 mm rubber mat, creating an overlap. The impact sound deadening board is used for decoupling under ceramic flooring, laminate or ready-to-lay parquet.

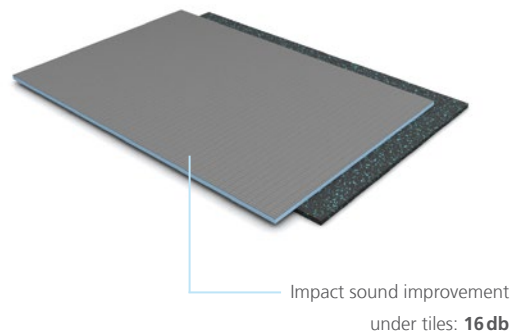



wedi Tools® edge insulation strips

The wedi Tools edge insulation strip prevents the transfer of noise between the wedi Fundo shower element and adjacent areas such as wall, floor or screed etc. thus it is an indispensable complement to the wedi Nonstep ProS sound-insulation mat.

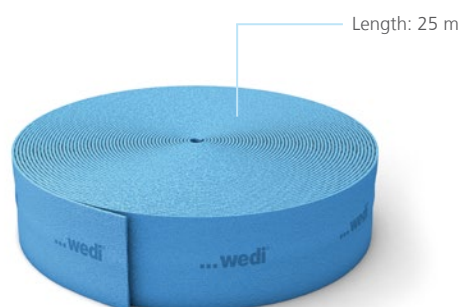

Product overview

wedi 320



universal tile adhesive
25 kg / bag

wedi 360



Flexible medium-bed mortar
25 kg / bag

wedi 610



adhesive sealant
310 ml / cartridge
600 ml / tubular bag

wedi 620



sealant
290 ml / cartridge

wedi 520



flexible sealant
powder component, 20 kg
liquid component, 10 kg

wedi Fundo sealing set



powder component, 2,4 kg
liquid component, 1,2 kg
wedi Tools sealing tape
wedi Tools inside corners

wedi Tools wall sealing set



wedi Subliner Dry
wedi Tools sealing tape
wedi Tools sealing gaiter
wedi 520 flexible sealant

wedi Tools sealing tape



10 m × 120 mm × 1 mm
50 m × 120 mm × 1 mm
50 m × 100 mm × 1 mm

wedi Tools corners



inside
120 × 120 × 60 mm

outside
167 × 167 × 60 mm

wedi Tools sloped lip-end sealing tape corner installation



for Fundo Riolito
226 × 110 × 66.75 mm
276 × 110 × 75.75 mm

wedi Tools sloped lip-end sealing tape, wall/floor

for Fundo Riolito
226 × 100 × 65 mm
276 × 110 × 75 mm

wedi Tools sloped lip-end sealing tape

**for Fundo Riolito Neo,
Plano Linea**
160 × 100 × 65 mm
160 × 100 × 75 mm

wedi Tools cut-resistant tape

10 m × 35 mm × 0,9 mm

wedi Tools sealing gaiters**sealing gaiter**

130 × 130 × 1 mm
Pipe diameter 10-24 mm

150 × 150 × 1 mm
Pipe diameter 35-50 mm

sealing gaiter floor

370 × 370 mm

200 × 200 × 1 mm
Pipe diameter 50-75 mm

250 × 250 × 1 mm
Pipe diameter 90-125 mm

wedi Tools butyl bathtub sealing tape

3.600 × 120 × 1 mm

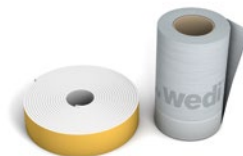
wedi Tools butyl bathtub sealing tape**incl. self-adhesive
decoupling strip**

3.600 × 120 × 1 mm
3.600 × 120 × 1 mm

wedi Subliner Dry & Flex

**sealing and decoupling
membrane**
15 × 1 m × 0.8 mm

wedi Subliner Dry

sealing membrane
5 × 1 m × 0.5 mm
30 × 1 m × 0.5 mm

wedi Subliner Flex

decoupling membrane
30 × 1 m × 0.5 mm

wedi Tools reinforcement tape

25 m × 125 mm
50 m × 600 mm

self-adhesive
25 m × 125 mm
50 m × 600 mm

wedi Tools washer



galvanised metal
35 mm

stainless steel
35 mm

wedi Tools metal dowels



galvanised metal
50 mm, 80 mm, 110 mm,
140 mm, 200 mm

stainless steel
80 mm, 110 mm, 140 mm

wedi Tools cavity dowels set



screws
Ø 4.5 x 60 mm

raw plugs
Ø 6.0 x 35 mm

wedi Top Wall installation set



wedi Tools edge strips



1.600 x 50 x 40 mm
1.800 x 60 x 40 mm
1.800 x 100 x 40 mm

wedi Nonstep ProS

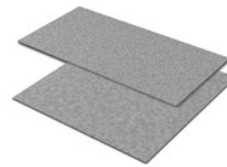

900 x 900 x 9 mm
1.200 x 600 x 9 mm

wedi Nonstep Plan

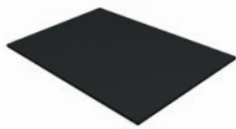

1.196 x 590 x 6 mm

wedi Nonstep Plus

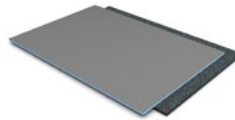

1.200 x 600 x 12 mm

wedi Tools edge insulation strips



25 m x 150 mm x 5 mm

All technical information online

www.wedi.eu

The wedi world of systems contains a multitude of individual elements which can be variably used and modularly expanded. You can find various technical documents which give you an overview of the respective formats, dimensions and technical requirements, as well as internationally usable installation instructions and videos at www.wedi.de/en/downloads so that you can plan efficiently and you are always on the safe side.

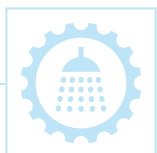
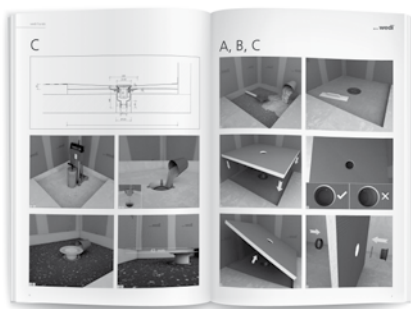

You can plan your shower quickly and easily online with the wedi Shower Configurator. The practical tool guides you through the various possibilities step by step and recommends the right wedi product for your individual initial situation.

www.wedi.de/en/shower-configurator

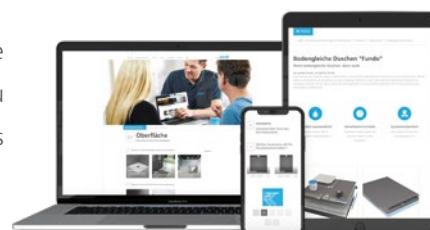



Customised & modular construction

Manufacturing and project competence in one place

We advise you from A to Z – from project planning through technical advice and design to logistical organisation and the construction phase on site. Take advantage of the numerous benefits of our individual, customer-specific modular building systems with integrated technology, high degree of prefabrication and the expertise of our experienced specialists and international partner network:

- 100 % waterproof system
- Base material is simultaneously light and strong
- Precision production of custom elements
- High degree of prefabrication for complex custom components
- Integration of technical elements in the factory
- Simple, quick and safe installation

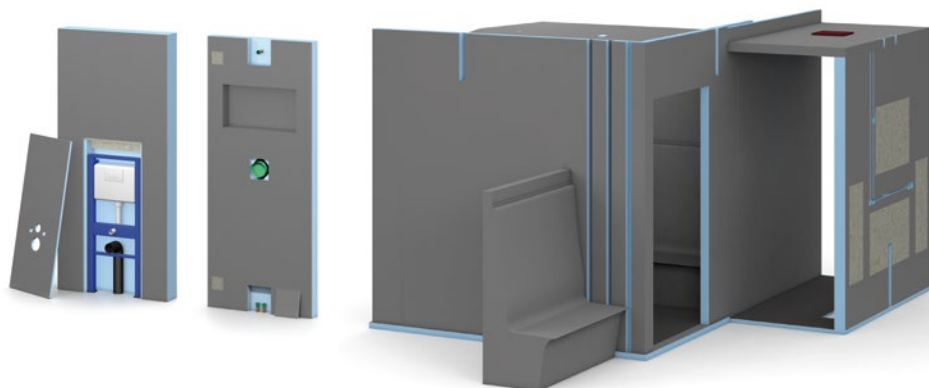

Modular construction

Ready-to-assemble systems for designing and refurbishing

With its modular system components, wedi creates brand new opportunities for designing individual, on-trend bathrooms and wet rooms. Lightweight and at the same time enormously stable wedi modules allow for the realisation of almost anything from the floor to the ceiling and practically everything else in-between: free-standing or partially attached creative partitions, shower solutions, customised bathroom furniture or complete system solutions for spa and wellness areas for example.

Our individually made module components are always tested, load-bearing and 100 % watertight structures – easier, quicker and safer than any other conventional drywall designs. Each module is custom-made. The degree of prefabrication can be freely selected: from power cables and cold and warm water pipes built in at the factory and load-bearing reinforcements, cable ducts and empty conduits through to ready-to-use technical components and fittings. All custom-made items are assembled in the wedi factory and subjected to a thorough test before delivery.





Individual spa & wellness elements

Pool & underwater structures

The experienced wedi project team realises swimming pools, whirlpools and underwater elements, such as steps and benches, exactly according to the client's ideas and specifications. Due to the completely free shaping of all elements, countless design possibilities arise.

If desired, recesses and feed-throughs can already be incorporated at the factory, e.g. for on-site massage jets or lighting technology. This reduces the assembly effort and increases the quality of the installation.

Individually
produced in
the factory

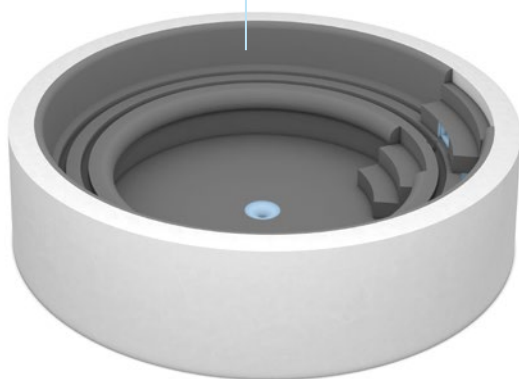

Can be equipped
with LED technology

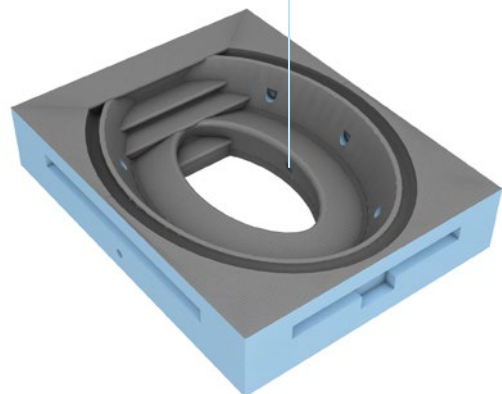

Individual steam baths

wedi offers countless options for designing a steam bath. From the choice of the cabin geometry through the design of the vapour coating on the roof, comfortable seating and bath furniture to the technical equipment and furnishings, a multitude of details can be planned and realised according to the client's requirements. Wall and roof elements can be coated in the factory, milled recesses for cables can be incorporated into the individual modules or lighting and sound technology can be integrated during the manufacturing process. Quick installation is guaranteed thanks to the accuracy of fit and the lightness of the materials from wedi.

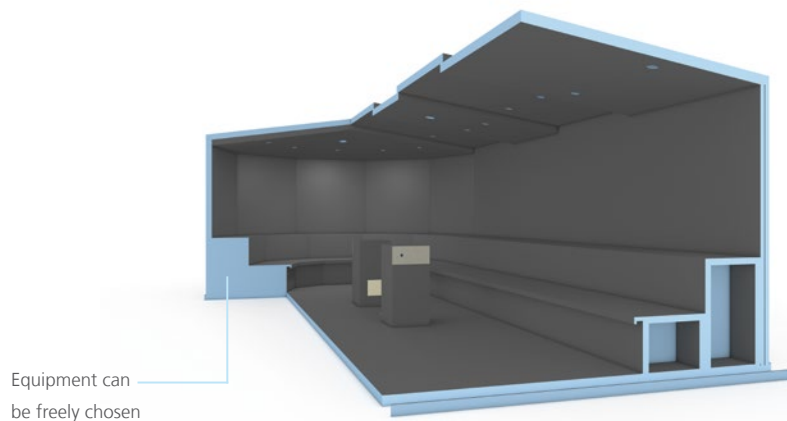



...wedi

01 Oberfläche

Bitte wählen Sie die Art der Oberfläche.

Welche Art der Oberfläche wollen Sie verwenden?



Wünschen Sie eine Punkt- oder Linienabstimmung?

wedi services

Real added value for an unrivalled peace of mind

wedi meets the highest customer expectations with solutions that take economic success, ecological reason and social responsibility into consideration in equal measure.

On the following pages, you will find a compact overview of our services and their benefits to you:

- wedi quality guarantee
- Peace of mind thanks to numerous test certificates
- Responsibility to people and the environment

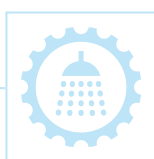

You can plan your shower quickly and easily online with the wedi Shower Configurator. The practical tool guides you through the various possibilities step by step and recommends the right wedi product for your individual initial situation.



wedi.de/en/shower-configurator

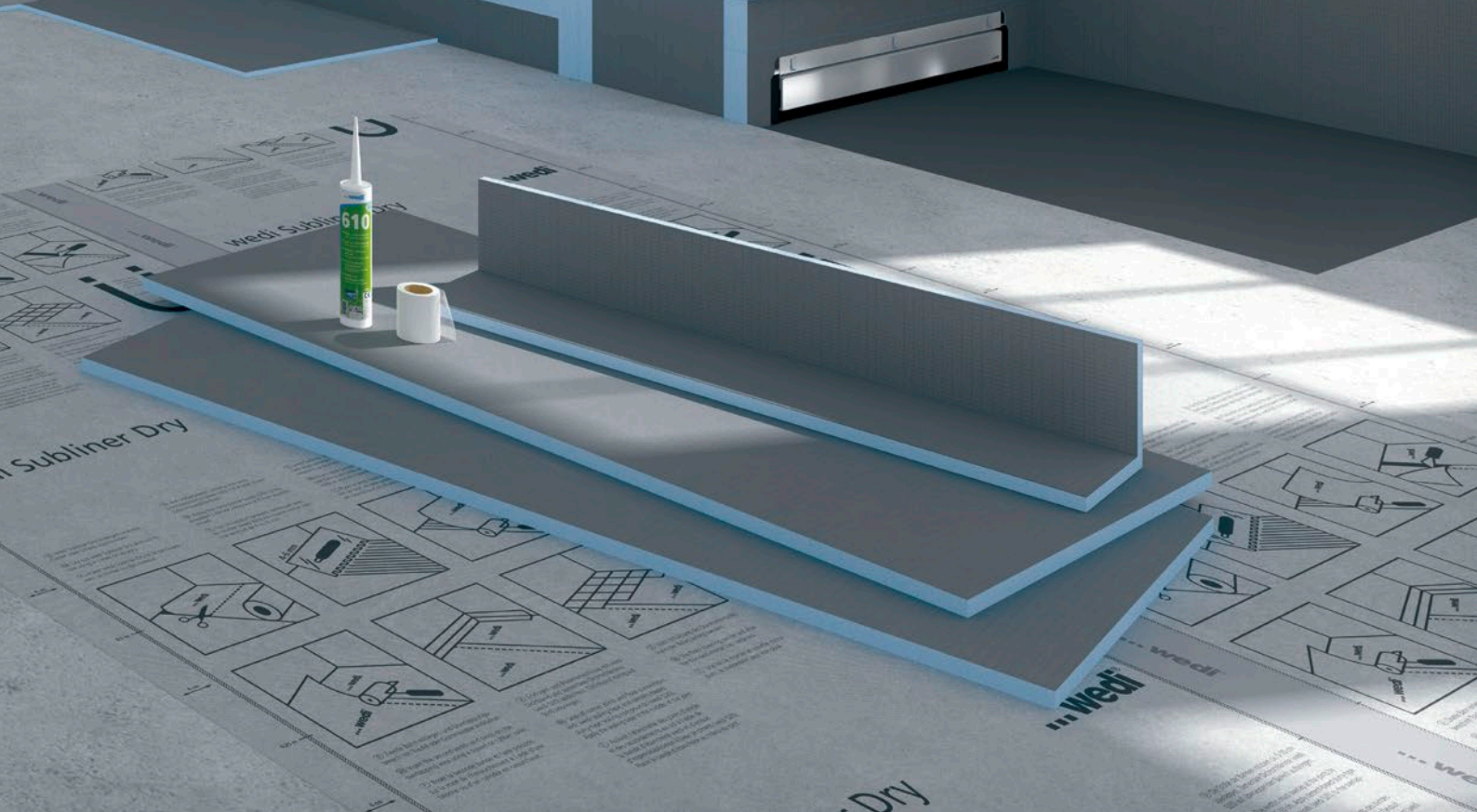
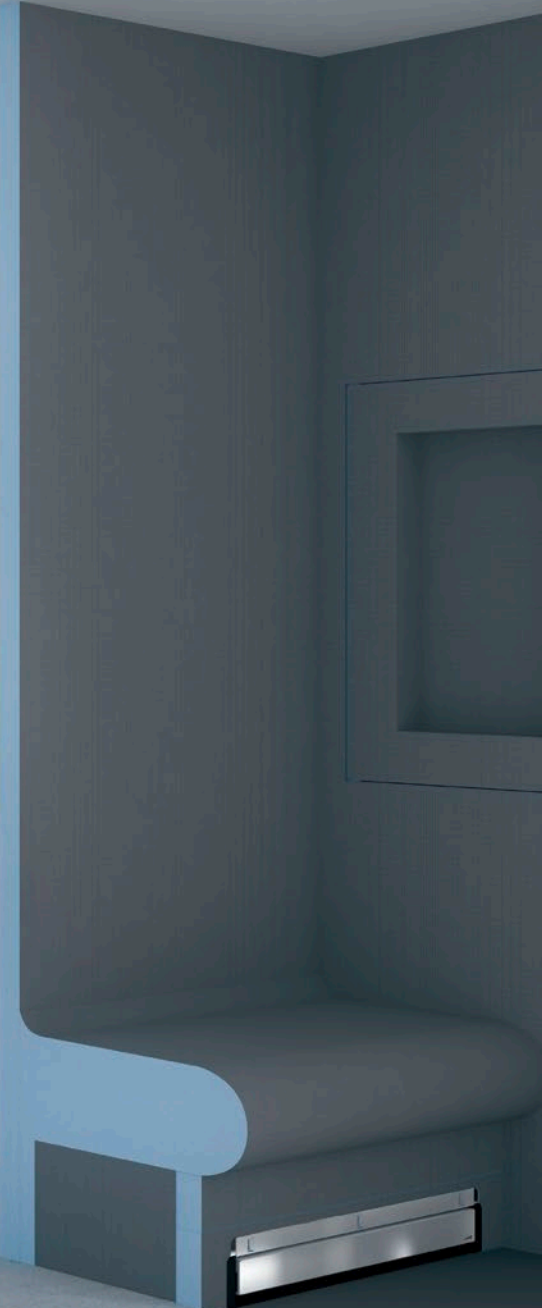
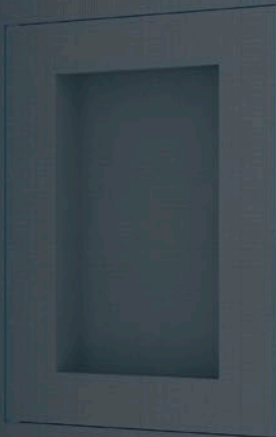
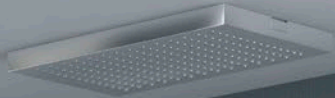

A real guarantee opposed to just a warranty

The wedi quality guarantee

With the extended guarantee services on products and systems, wedi sets new standards in quality leadership. wedi offers not only a statutory warranty, but also a voluntary additional performance commitment in the form of the 10 year quality guarantee.



10 year guarantee
on the entire price list
range from wedi

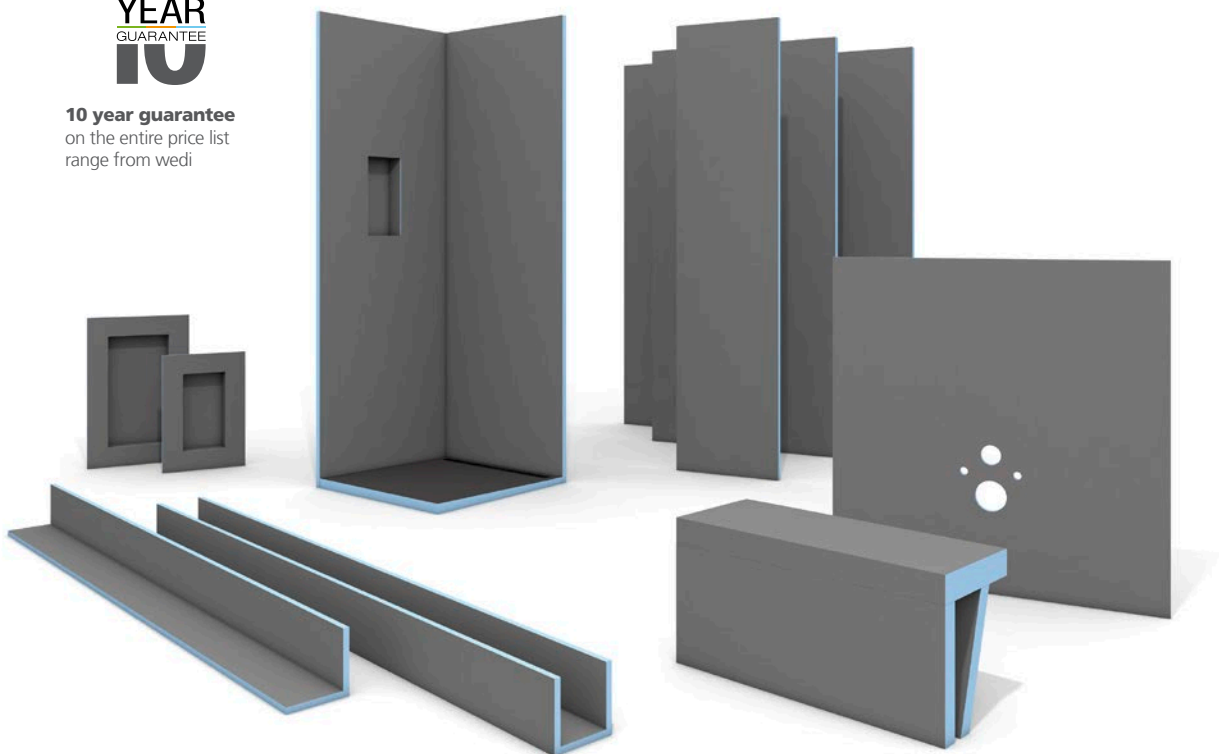

We provide security



0799 (System 2+)

The CE labelling of the wedi products documents their tested and approved use as a sealing system for wet rooms.

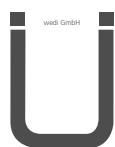

Modular system solutions from wedi have a wide range of differing technical building approvals and test certificates.



The barrier-free wedi products have been tested, assessed and certified for their conformity by DIN CERTCO Gesellschaft für Konformitätsbewertung mbH.



The integrated wedi environmental management system is certified by the independent certification body GUTcert: certified in 2019 in accordance with ISO 14001.



Systems from wedi are labelled in accordance with the French VOC regulations. A+ stands for exceptionally low emission, non-hazardous product systems.



The wedi product systems have been tested and approved in France by the Centre Scientifique et Technique du Bâtiment (CSTB), a technical and scientific institute which deals with issues relating to construction quality and building safety.



The wedi product systems satisfy the construction guidelines and regulations that are applicable in England, Wales, Northern Ireland and Scotland.



The compliance of wedi products and systems with national standards and the construction regulation requirements is tested and approved for the US market by the US testing institute ICC-ES.



The MK test seal qualifies wedi products for use in Denmark in accordance with the country-specific guidelines, norms and standards.



The Norwegian test seal, which corresponds to the European requirements, certifies the high technical quality of the wedi product systems.



The wedi quality management system and the high product quality are indicated by the Finnish eurofins test seal.



The wedi construction systems are labelled with the leading Finnish emissions classification. In this context, M1 stands for the highest quality.

Social and environmental responsibility

Certified environmental management system in accordance with ISO 14001

Environmental responsibility is actively practised at wedi. From the procurement of the raw materials through development and production to sales and the in-house wedi logistics – wedi is committed to complying with all relevant environmental provisions and continuously improving all processes with regard to sustainability and conservation of resources. Coordination of and compliance with the strict guidelines is done through the company-wide environmental management system.

The effectiveness of the holistic wedi environmental management system is attested to here by the independent certification body GUTcert: wedi was certified in accordance with the internationally recognised environmental standard ISO 14001 in 2019. Here, compliance with the standards is not only reviewed annually, it is also continuously managed and monitored by appropriate officers in the company. The wedi products and processes should thus also support customers, partners and suppliers with the sustainable handling of energy and environmental resources.





wedi GmbH

Hollefeldstraße 51
48282 Emsdetten
Germany

Telefon +49 2572 156-0
Telefax +49 2572 156-133

info@wedi.de
www.wedi.eu

