

COLUMBUS-DRIVE

EX60



**Tiara**  
YACHTS

2024 OWNERS MANUAL

## CALIFORNIA PROPOSITION 65 WARNING



### **WARNING**

**WARNING:** Operating, servicing and maintaining a recreational marine vessel can expose you to chemicals including engine exhaust, carbon monoxide, phthalates, and lead, which are known to the State of California to cause cancer and birth defects or other reproductive harm. To minimize exposure, avoid breathing exhaust, service your vessel in a well-ventilated area and wear gloves or wash your hands frequently when servicing this vessel. For more information go to [www.P65warnings.ca.gov/marine](http://www.P65warnings.ca.gov/marine).



Welcome to the family of Tiara Yachts boat owners and congratulations on your purchase of your new Tiara.

We understand there are many choices available to you, and we appreciate the investment that you've made and the subsequent faith and confidence that you've placed into our product. Hopefully, during the selection and buying process, you discovered that each Tiara has been designed, engineered, and built with care and precision.

When our company was started, it was the goal of my father, Leon Slikkers, to provide you with the finest quality boat available. We want to be the best and deliver the best to you. And part of that includes a delightful ownership experience. Everything we have achieved since our humble beginnings has been with this same goal in mind.

The information within this owner's manual was assembled to assist you in understanding how to operate your boat to obtain the maximum enjoyment of your Tiara. So please take time to read the manual completely and please operate your boat safely and courteously.

I would also like to ask you a personal favor. Shortly, you will receive a survey asking for your opinion about the sales process you experienced when you purchased your boat. Approximately nine months later, you'll be sent another survey inquiring about your ownership experience. By taking a few minutes to complete these surveys, you will be providing us with valuable information.

Best wishes for many happy hours aboard your new Tiara Yacht,

A handwritten signature in blue ink, appearing to read "T. Slikkers", with a long horizontal flourish extending to the right.

Thomas B. Slikkers  
CEO/President S2 Yachts

**This page intentionally left blank.**



# LIMITED WARRANTY

## 2024 MODELS TIARA YACHTS, INC. LIMITED WARRANTY COVERAGE

Tiara Yachts, Inc. (Tiara) provides limited warranty coverage on Tiara Yachts products sold for use by retail (non-commercial) customers, as described in this Limited Warranty. For customers in the U.S.: this warranty gives you specific legal rights; you also may have other rights, which vary from state to state. For customers in the European Union: the purchaser may have additional legal rights under applicable national legislation governing the sale of consumer goods, and those rights (if applicable) are not affected by this warranty.

This warranty is provided only to the original purchaser of the boat from an authorized Tiara Yachts dealer but can be transferred to subsequent owners. Contact Tiara's Customer Relations Department if you need information about transferring this warranty. No warranty coverage is provided to subsequent owners unless they follow Tiara's transfer procedures. This warranty does not extend or apply to anyone else. The terms of this written warranty cannot be changed or modified, except by a written agreement signed by an officer of Tiara Yachts, Inc.

### COVERED PRODUCTS AND LIMITATIONS:

Tiara's limited warranty coverage applies only to:

1. Defects in materials and workmanship in the boat and all components and accessories (except for the excluded items described below) for a period of two (2) years;
2. Structural defects in materials and workmanship in the hull and deck for a period of five (5) years;
3. Blistering due to defects in material and workmanship in the gelcoat surface of the hull bottom for a period of five (5) years, provided that the gelcoat surface has not been altered in any way such as sanding, sandblasting or application of a coating other than standard antifouling paint, any of which will void this warranty.

Each of the warranty coverage periods runs from the date of purchase of the boat from an authorized Tiara Yachts dealer and applies only to warranted defects that first manifest themselves and are reported to Tiara within the applicable warranty period. Tiara retains the right to determine to its reasonable satisfaction whether any claimed defect is covered by this warranty.

Certain items are excluded from warranty coverage by Tiara, and this limited warranty coverage does not apply to:

1. Engines, transmissions, generators, air conditioning systems, swim platforms and lifts, seakeeping systems, electronics and batteries, and other components manufactured by other manufacturers. These products may come with separate warranties from their manufacturers; see the Owner Packet for warranty registration requirements and details on these products.
2. Dealer final assembly and pre-delivery commissioning, and dealer installed components.
3. Scratching, chipping, discoloration or flaking of any powder coated or painted surface including engines and hardtop components.
4. Gelcoat stress cracking, chalking, fading or discoloration. This includes bilge gelcoat.
5. Damage caused by accident, wear, storm damage, grounding, towing, commercial use of the boat, or misuse or abuse, or deterioration resulting from normal use (including gaskets, seals, springs, wipers and sealants).
6. Maintenance, adjustments or realignments to any components including latches, hinges, hatches, doors and drive train components.
7. Mold, mildew, upholstery damage or deterioration and cleaning.
8. Damage or deterioration resulting from environmental conditions, including electrolysis, crevice or galvanic corrosion, any deterioration of underwater equipment, or any damage or deterioration resulting from any failure to undertake reasonable, routine maintenance.

9. Any repairs, adjustments, alterations or modifications made by anyone other than an employee of Tiara Yachts, or an authorized Tiara Yachts dealer with Tiara's prior, written authorization.
10. Damage which has occurred as a result of the boat being operated as a demonstrator and/or displayed for sale.
11. Damage or deterioration of the hull or deck structure due to the attachment of hardware or other components.
12. Weight, speed, fuel consumption or other performance characteristics.
13. Damage or deterioration resulting from improper trailering, hauling, launching or storage.
14. Boats purchased or used for commercial or governmental purposes or uses.

### REMEDIES UNDER THIS LIMITED WARRANTY

If a defect covered by this warranty occurs, Tiara (or one of its authorized dealers, as determined by Tiara) will repair and replace the defective component, in its sole discretion. This 'repair or replacement' remedy is the exclusive remedy under this warranty. Tiara has no responsibility or liability for any consequential or incidental damages, such as loss of use, storage charges, interest or finance charges, insurance or depreciation, transportation or lodging charges, or charges for towing or hauling out, etc. which are specifically excluded and disclaimed from this warranty. For customers in the U.S.: some states do not allow the exclusion or limitation of incidental or consequential damages, so the above limitation or exclusion may not apply to you. UNDER CERTAIN APPLICABLE LAWS, THERE MAY BE NO IMPLIED WARRANTIES OR GUARANTEES FROM TIARA APPLICABLE TO YOUR BOAT, AND ALL IMPLIED OR STATUTORY CONDITIONS AND WARRANTIES (INCLUDING ANY WARRANTY OF MERCHANTABILITY OR FITNESS FOR A PARTICULAR PURPOSE) AND GUARANTIES ARE DISCLAIMED WHERE ALLOWED BY LAW. TO THE FULLEST EXTENT ALLOWED BY LAW, ANY AND ALL APPLICABLE IMPLIED WARRANTIES AND GUARANTIES (IF ANY), INCLUDING ANY IMPLIED WARRANTY OF MERCHANTABILITY OR PARTICULAR PURPOSE, ARE LIMITED IN DURATION TO THE DURATION OF THE APPLICABLE PROVISIONS OF THIS WRITTEN WARRANTY. For customers in the U.S.: some states do not allow limitations on how long an implied warranty lasts, so the above limitation may not apply to you.

### RESPONSIBILITY OF PURCHASER

1. No warranty coverage is provided by Tiara unless the customer and dealer complete and return all Vessel Registration and Customer Acceptance Forms to Tiara Yachts, Inc. within seven (7) days after delivery of the boat to the original purchaser.
2. The original purchaser or approved transferee must notify the Tiara Yachts dealer from which the boat was purchased of any claimed defect within fifteen (15) days after first detecting the claimed defect. Warranty work in excess of \$500 requires Tiara's prior written approval.
3. If the dealer fails to satisfactorily repair the claimed defect within fifteen (15) days, written notice must then be promptly given directly to Tiara. Tiara is not responsible for unrepaired warranted defects.
4. The boat, including any claimed defective part, must be returned to the Tiara Yachts dealer from which the boat was purchased (or to another dealer or facility as directed by Tiara Yachts) within the warranty period for inspection and warranty service. The expense of returning and transporting the boat or any part for warranty service, and the expense of returning and transporting it back to the owner after repair or replacement, is the responsibility of the owner, and will not be reimbursed by Tiara.
5. If the dealer from whom the boat was purchased is no longer an authorized Tiara Yachts dealer, contact Tiara for instructions on how to obtain warranty service.

S2 reserves the right to improve its products through changes in design or materials without being obligated to the owners of the boats of similar or the same model of prior manufacture. We may be contacted as follows: Tiara Yachts Customer Relations Department, 725 East 40th Street, Holland, Michigan 49423 (616/394-7460) or CR@tiarayachts.com.



## **SUPPLEMENTAL LIMITED WARRANTY INFORMATION ON FINISHED WOOD COMPONENTS**

Your Tiara Yachts® Boat may be furnished with certain finished wood panels and components that require periodic maintenance and refinishing to maintain their appearance and finish. S2 Yachts, Inc.'s Limited Warranty coverage does not include the matching of wood grains, or the condition or durability of any finishes for such panels and components. This statement supplements S2 Yachts, Inc.'s Limited Warranty with respect to these wood panels and components. All other terms of S2 Yachts, Inc.'s Limited Warranty remain in effect, and you should refer to the Limited Warranty for other terms, conditions and requirements

# Safety Information

---

Your owner's manual was written to include safety instructions to ensure safe operation and maintenance of your boat. This manual uses safety symbols to alert you to potential personal injury hazards.

 **DANGER**

Indicates a hazardous situation which, if not avoided, will result in death or serious injury.

 **WARNING**

Indicates a hazardous situation which, if not avoided, could result in death or serious injury.

 **CAUTION**

Indicates a hazardous situation which, if not avoided, could result in minor or moderate injury.

 **NOTICE**

Indicates a potentially hazardous situation which, if not avoided, may result in property damage.

All instructions in this manual should be viewed from the stern looking toward the bow, with starboard to your right and port to your left. A glossary of boating terms is included.

Your boat produces carbon monoxide (CO) and uses flammable fuel. Carbon monoxide gas (CO) is colorless, odorless and extremely dangerous. CO will cause BRAIN DAMAGE or DEATH.

Every precaution has been taken by S2 Yachts to reduce the risks associated with death, possible injury and damage from fire or explosion. Your own precaution and good maintenance procedures are necessary in order to enjoy safe operation of your boat.

 **DANGER**

Exposure to carbon monoxide will cause death or serious injury. Avoid direct and prolonged exposure to CO.

Gasoline and other fuels are extremely flammable and highly explosive under certain conditions.

- DO NOT smoke or allow open flame or sparks nearby when fueling.
- DO NOT block fuel vents.
- DO NOT store fuel in any containers or compartments which are not designated for storing fuel.





# Table of Contents

---

## Safety Labels

Interior .....	1
Exterior .....	2

## General Information

Engine and General Specifications .....	11
Boat Information .....	12

## Pre-Cruise Checklist

Fire Extinguisher Locations .....	15
Pre-Cruise Checklist.....	15

## Propulsion Systems

1.1 General.....	1-1
1.2 Engine Lubrication.....	1-1
1.3 Propellers .....	1-1
1.4 Engine Instrumentation.....	1-1
1.5 Seakeeper Gyro Stabilization System (optional).....	1-2

## Helm Systems

2.1 General.....	2-1
2.2 Helm Access.....	2-1
2.3 Engine Monitoring Displays.....	2-1
2.4 Engine Throttle and Shift Controls.....	2-1
2.5 Starting Your Engines .....	2-2
2.6 Automatic Fire Suppression System .....	2-3
2.7 Steering System .....	2-3
2.8 Volvo Interceptor Boat Trim System .....	2-4
2.9 Compass .....	2-4
2.10 Joystick.....	2-5

## Fuel Systems

3.1 Fuel System.....	3-1
3.2 Diesel Generator Fuel System .....	3-4
3.3 Fuel System Maintenance.....	3-4

## Electrical Systems

4.1 General.....	4-1
4.2 Power-Up Panel .....	4-1
4.3 24V DC System .....	4-2
4.4 12-Volt DC Helm Switches .....	4-5
4.5 DC Distribution Panel .....	4-6
4.6 Seakeeper Gyro (optional) .....	4-7
4.7 AC System.....	4-7
4.8 Shore Power.....	4-10
4.9 Generator .....	4-11

## Plumbing Systems

5.1 Freshwater System.....	5-1
5.2 Freshwater System Commissioning .....	5-2
5.3 Marine Head System .....	5-5
5.4 Washdowns .....	5-7
5.5 Drainage .....	5-8
5.6 Plumbing System Maintenance .....	5-9

## Ventilation Systems

6.1 Air Conditioning System .....	6-1
6.2 Carbon Monoxide .....	6-1
6.3 Bilge Ventilation .....	6-1
6.4 Maintenance .....	6-1

# Table of Contents

---

## Exterior Equipment

7.1 Forward Deck .....	7-1
7.2 Lighting .....	7-4
7.3 Alfresco Cockpit.....	7-4
7.4 Aft Cockpit .....	7-5
7.5 Exterior Galley .....	7-7
7.6 Stern .....	7-8

## Interior Equipment

8.1 Safety Equipment .....	8-1
8.2 Helm .....	8-1
8.3 Salon and Galley .....	8-2
8.4 Lighting .....	8-3
8.5 Master Stateroom .....	8-3
8.6 Master Head Compartment .....	8-4
8.7 Forward VIP Stateroom .....	8-4
8.8 VIP Head Compartment .....	8-4
8.9 Third Stateroom.....	8-5
8.10 Marine Head System .....	8-5
8.11 Access to Components .....	8-5

## Safety Information

9.1 General.....	9-1
9.2 Engine Alarms .....	9-1
9.3 Neutral Safety Switch .....	9-1
9.4 Engine Stop Switch .....	9-1
9.5 Fire Safety .....	9-2
9.6 Carbon Monoxide Safety .....	9-4
9.7 First Aid.....	9-6
9.8 Required Safety Equipment.....	9-6
9.9 Additional Safety Equipment.....	9-8

## Operation

10.1 General.....	10-1
10.2 Homeland Security Restrictions .....	10-2
10.3 Rules of the Road.....	10-2
10.4 Operating your Boat .....	10-3
10.5 Docking, Anchoring, and Mooring.....	10-5
10.6 Controls, Steering, or Propulsion System Failure .....	10-7
10.7 Collision.....	10-7
10.8 Grounding, Towing, and Rendering Assistance.....	10-7
10.9 Flooding or Capsizing.....	10-8
10.10 Transporting your Boat .....	10-8
10.11 Man Overboard.....	10-8
10.12 Trash Disposal.....	10-9
10.13 Multi-Colored Lighting.....	10-9

## Routine Maintenance

11.1 General .....	11-1
11.2 Exterior Hull and Deck .....	11-1
11.3 Seats and Upholstery .....	11-5
11.4 Cabin Interior .....	11-6
11.5 Bilge.....	11-6
11.6 Engines .....	11-6
11.7 Oil Change System.....	11-7
11.8 Electrical .....	11-7
11.9 Generator.....	11-7

## Seasonal Maintenance

12.1 Winterizing.....	12-1
12.2 Storage and Lay-up .....	12-3
12.3 Recommissioning .....	12-5

# Table of Contents

---

## Appendices

Glossary of Terms.....A-1  
Maintenance Guides.....B-1  
Maintenance Schedule ..... C-1  
Boating Accident Report..... D-1  
Float Plan .....E-1  
Troubleshooting Guide ..... F-1  
Electrical Schematics ..... G-1



# Safety Labels

The following diagrams indicate where safety labels can be found on your Tiara. The numbers correspond to the list in the table that follows. To obtain replacement labels refer to the part number of the label in the table and contact your Tiara dealer. Label placement and content are accurate at the time of printing.

## Interior

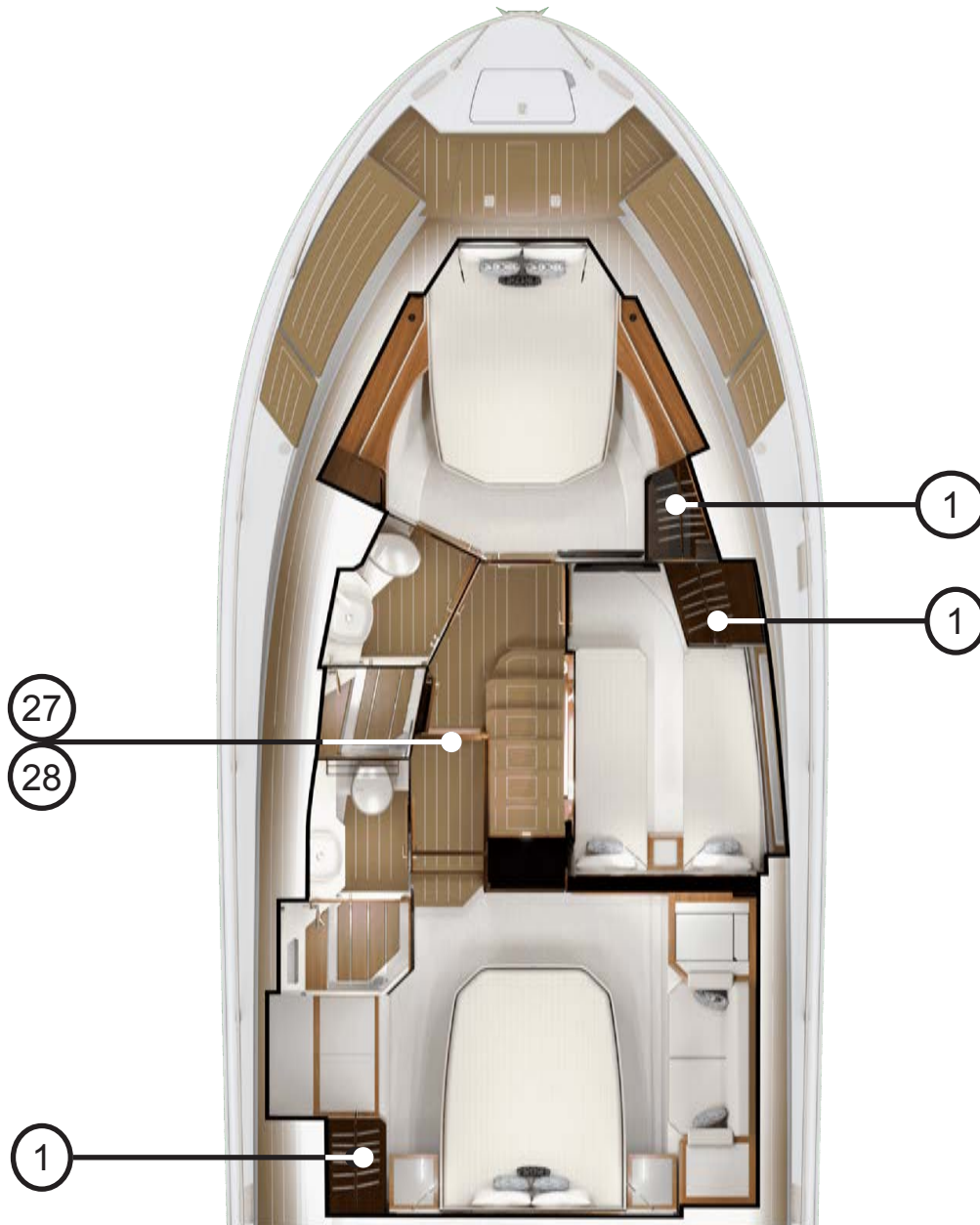

## Exterior

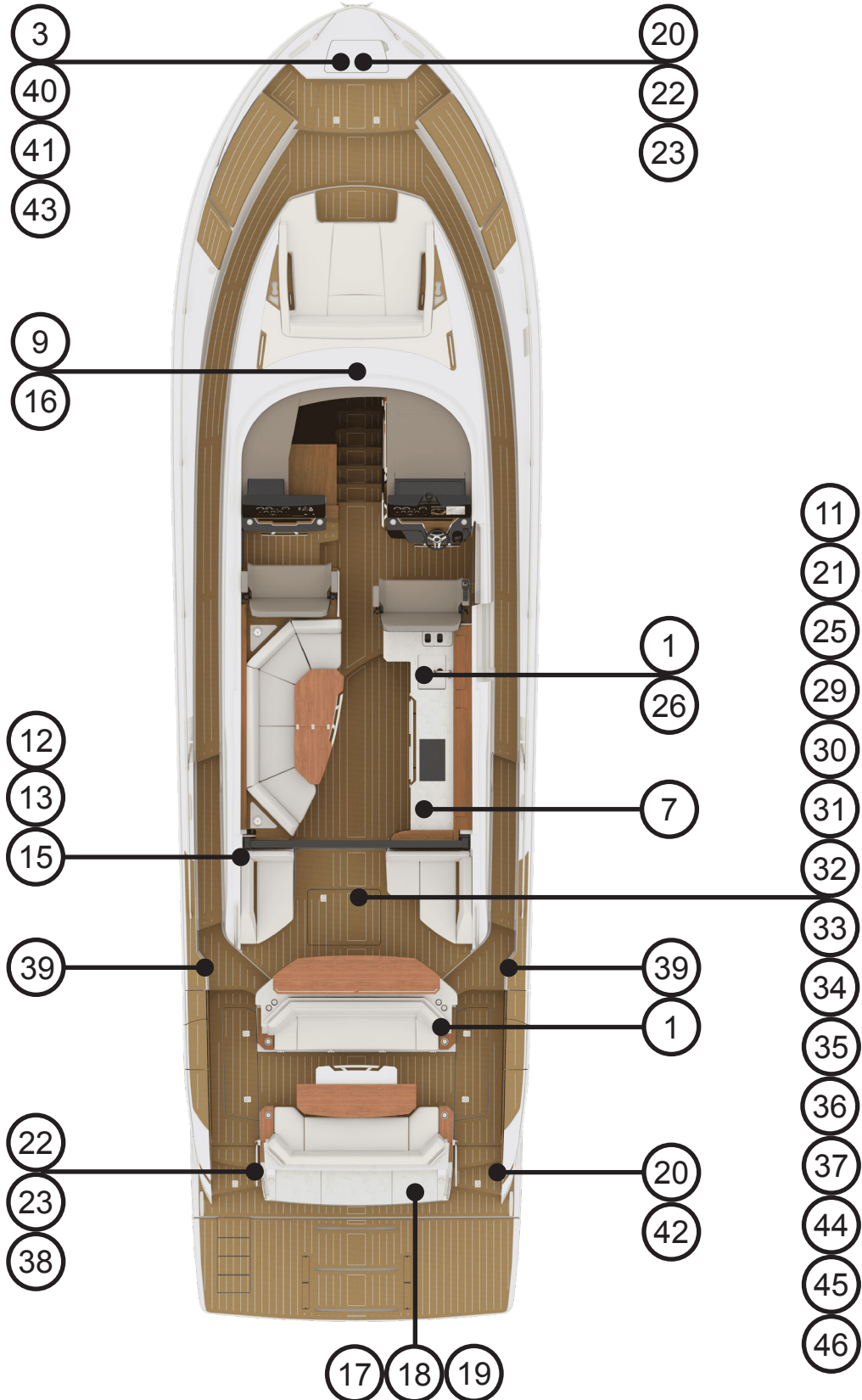





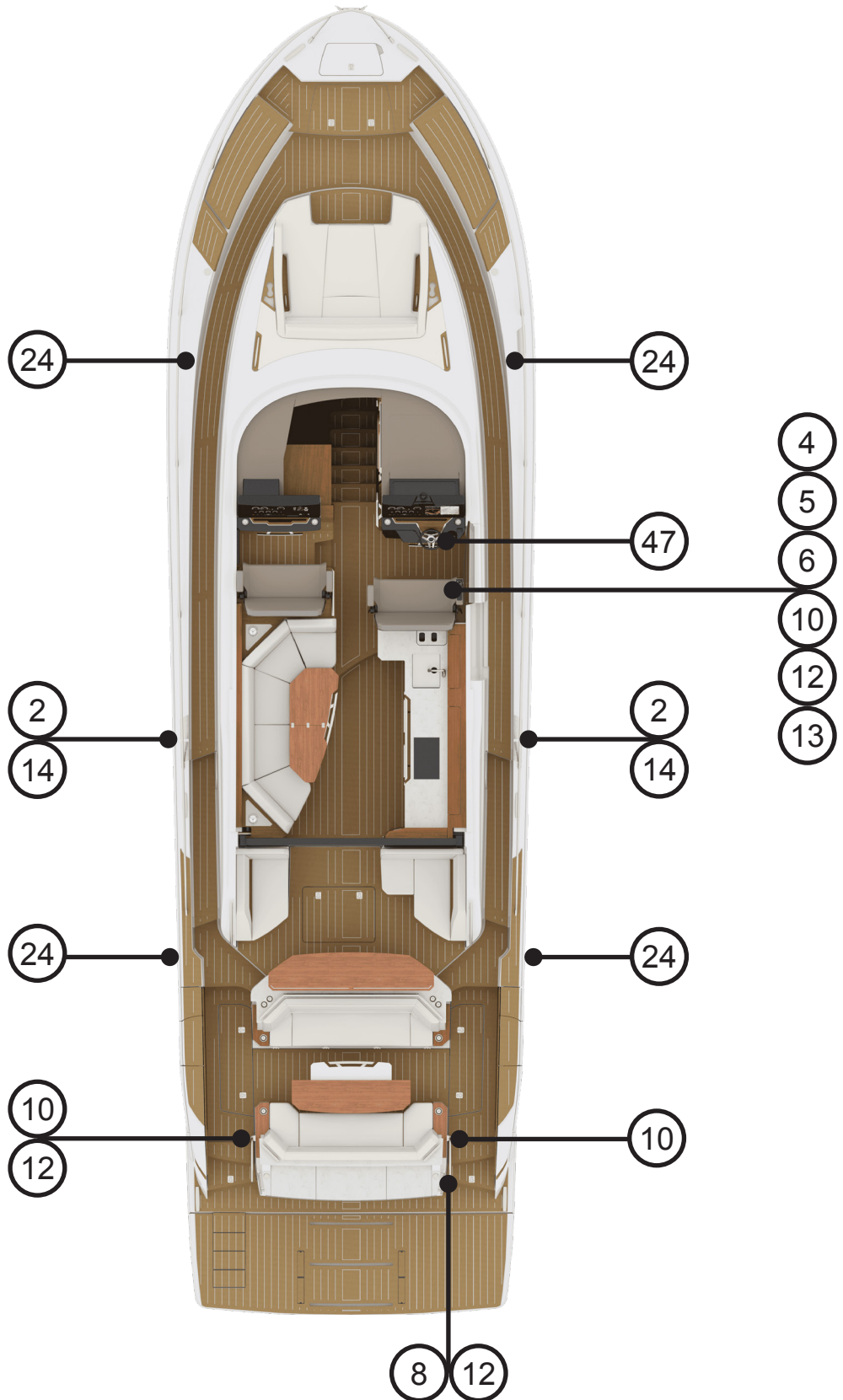

# Safety Labels

---

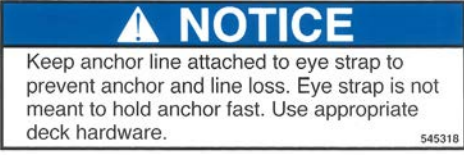

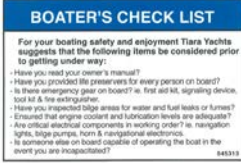

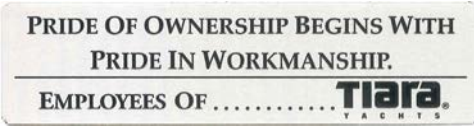
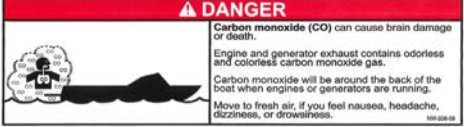



# Safety Labels





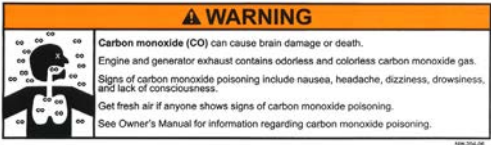

<p>1</p>	<p>FIRE EXTINGUISHER INSIDE P/N: 5452010</p> <p>Locations: master stateroom port hanging locker; VIP and third stateroom starboard hanging lockers; under the starboard galley sink; and the aft cockpit starboard aft-facing seat base.</p>	
<p>2</p>	<p>NO SMOKING P/N: 5451130</p> <p>Location: Port &amp; starboard fuel fills</p>	
<p>3</p>	<p>NOTICE: LINE LOSS P/N: 5453180</p> <p>Location: Underside of anchor locker hatch</p>	
<p>4</p>	<p>NOTICE: FIRE EXTINGUISHING SYSTEM P/N: 5453300</p> <p>Location: Under helm seat</p>	
<p>5</p>	<p>BOATERS CHECK LIST P/N: 5453130</p> <p>Location: Under helm seat</p>	
<p>6</p>	<p>YACHT CERTIFICATION PLATE P/N: 5450570</p> <p>Location: Under helm seat</p>	
<p>7</p>	<p>PRIDE OF OWNERSHIP P/N: 5450058</p> <p>Location: Under the starboard galley switch panel</p>	
<p>8</p>	<p>DANGER: CARBON MONOXIDE P/N: 5453670</p> <p>Location: Starboard side of transom buffet box</p>	





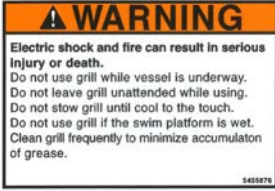



# Safety Labels

9	<p>WARNING: SEAT USE WHILE UNDERWAY P/N: 5455875 Location: Behind the bow lounge under the windshield</p>	 <p><b>WARNING</b> Occupying this seat/lounge while underway can result in serious injury or death. Do not use this seat/lounge while vessel is underway. 5455875</p>
10	<p>WARNING: CLOSE TRANSOM DOOR(S). P/N: 5453220 Location: Under helm seat &amp; aft of the port and starboard transom doors</p>	 <p><b>WARNING</b> Falling overboard can result in serious injury or drowning. Keep transom door(s) and gate closed while boat is under way. 545322</p>
11	<p>WARNING: LEAKING FUEL P/N: 5453150 Location: Engine room hatch</p>	 <p><b>WARNING</b> Leaking fuel is a fire and explosion hazard that can result in serious injury, burns or death. Inspect fuel system for leaks at least once a year. 545315</p>
12	<p>WARNING: ROTATING PROPELLERS P/N: 5455130 Location: Under the helm seat; inside the optional al fresco cockpit joystick box if installed; and on the port and starboard sides of the transom buffet box</p>	 <p><b>WARNING</b> Rotating propellers are dangerous and can cause serious injury or death. Do not use swim platform or ladder while engines are running. Stop engines if swimmers are present or attempting to board. 545513</p>
13	<p>WARNING: CARBON MONOXIDE P/N: 5453690 Location: Under helm seat and inside the port al fresco cockpit cabinet</p>	 <p><b>WARNING</b> Carbon monoxide (CO) can cause brain damage or death. Engine and generator exhaust contains odorless and colorless carbon monoxide gas. Signs of carbon monoxide poisoning include nausea, headache, dizziness, drowsiness, and lack of consciousness. Get fresh air if anyone shows signs of carbon monoxide poisoning. See Owner's Manual for information regarding carbon monoxide poisoning. 545369</p>
14	<p>FILL WITH DIESEL ONLY P/N: 5454580 Location: At port and starboard fuel fills</p>	 <p><b>FILL WITH DIESEL FUEL ONLY</b></p>
15	<p>WARNING: SUNSHADE STOWAGE P/N: 5450054 Location: Above the port al fresco cockpit cabinet</p>	 <p><b>WARNING</b> Excessive wind may cause damage or injury while the sunshade is deployed. The sunshade should be stowed in the hardtop when running above idle speeds or while in windy conditions. 5450054</p>



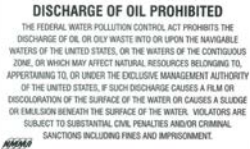
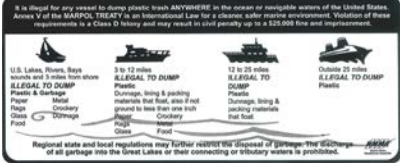

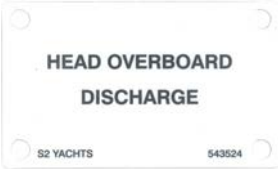
# Safety Labels

16	<p>WARNING: HARDTOP P/N: 5453160 Location: Under exterior windshield</p>	
17	<p>WARNING: FUEL VAPORS P/N: 5453240 Location: Inside trunk base</p>	
18	<p>WARNING: OPEN TRUNK P/N: 5455620 Location: Under transom trunk light</p>	
19	<p>WARNING: GRILL SHOCK AND FIRE P/N: 5455876 or 5455680 Location: Underside of grill lid</p>	 
20	<p>WARNING: HAZARDOUS VOLTAGE P/N: 5451110 Locations: Anchor locker and shorepower connection locker under the starboard transom step</p>	
21	<p>NOTICE: FIXED FIRE EXTINGUISHER SYSTEM P/N 5450132 Location: Engine room hatch</p>	
22	<p>FRESH WATER P/N: 5455490 Locations: Anchor locker and washdown connection under port transom step</p>	



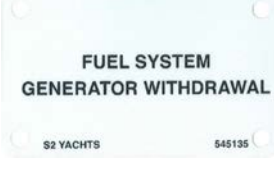
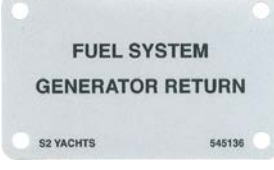

# Safety Labels



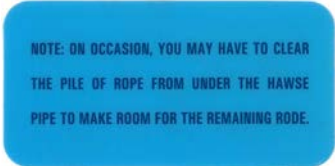

23	<p>RAW WATER P/N: 5455480</p> <p>Locations: Anchor locker and washdown connection under port transom step</p>	
24	<p>SLING P/N: 5450240</p> <p>Locations: Port &amp; starboard hull sides</p>	
25	<p>DISCHARGE OF OIL PROHIBITED P/N: 5450190</p> <p>Location: Underside of engine room hatch</p>	
26	<p>DUMPING TRASH OVERBOARD P/N: 5451640</p> <p>Location: Galley trash cabinet</p>	
27	<p>TAG: OVERBOARD DISCHARGE OF SEWAGE P/N: 5450050</p> <p>Location: Overboard discharge seacock in forward mechanical space beneath the master stateroom hallway sole</p>	
28	<p>TAG: HEAD OVERBOARD DISCHARGE P/N: 5435240</p> <p>Location: Overboard discharge seacock in forward mechanical space beneath the master stateroom hallway sole</p>	
29	<p>TAG: FUEL SYSTEM WITHDRAWAL STBD P/N: 5451290</p> <p>Location: Forward engine room bulkhead</p>	

# Safety Labels

<p>30</p>	<p>TAG: FUEL SYSTEM RETURN STBD P/N: 5451300 Location: Forward engine room bulkhead</p>	
<p>31</p>	<p>TAG: FUEL SYSTEM WITHDRAWAL PORT P/N: 5451310 Location: Forward engine room bulkhead</p>	
<p>32</p>	<p>TAG: FUEL SYSTEM RETURN PORT P/N: 5451320 Location: Forward engine room bulkhead</p>	
<p>33</p>	<p>TAG: FUEL SYSTEM GENERATOR WITHDRAWAL P/N: 5451350 Location: Forward engine room bulkhead</p>	
<p>34</p>	<p>TAG: FUEL SYSTEM GENERATOR RETURN P/N: 5451360 Location: Forward engine room bulkhead</p>	
<p>35</p>	<p>TAG: BATTERY MOUNTING REQUIREMENTS P/N: 5450160 Locations: Batteries in the engine room</p>	
<p>36</p>	<p>WARNING: DO NOT DRILL P/N: 5455830 Locations: Engine room port and starboard bulkheads</p>	

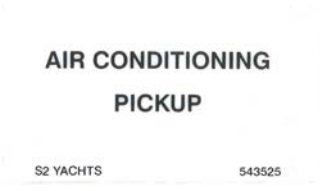
# Safety Labels

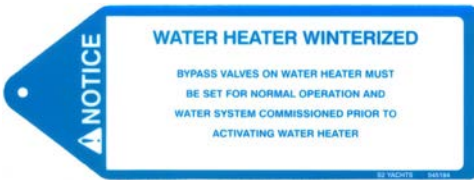
37	<p>NOTICE: WASHDOWN PICKUP  P/N: 5435260  Location: Forward of port engine hose</p>	 <p>A white rectangular label with four corner fasteners. The text reads: <b>WASHDOWN PICKUP</b>. At the bottom, it says 'S2 YACHTS' on the left and '543526' on the right.</p>
38	<p>WARNING: FLOODING OR DROWNING  P/N: 5450133  Location: Dockside water connection under port transom step</p>	 <p>A warning label with an orange header containing a triangle icon and the word <b>WARNING</b>. Below the header, it says <b>Flooding or drowning hazard</b>. The main text reads: 'A water system component failure can cause a flooding or drowning hazard which can cause death or serious injury. Do not leave boat unattended with the dockside water hose connected.'</p>
39	<p>WARNING: OVERLOAD HAZARD  P/N: 5450115  Location: Aft of port and starboard terrace door control buttons</p>	 <p>A complex warning label with an orange header containing a triangle icon and the word <b>WARNING</b>. It features three distinct hazard sections: 1. <b>Overload hazard</b>: 'Avoid serious injury or death from falling overboard! Do not exceed a maximum terrace door capacity of 650 LBS / 295 KG'. It includes a '650 LBS' icon. 2. <b>Falling hazard / Reduced Stability</b>: 'Avoid serious injury or death from falling overboard! Ensure terrace door is fully closed and locked before making way'. It includes a silhouette of a person falling. 3. <b>Pinch point</b>: 'Moving parts can crush and pinch. To avoid injury, keep hands and body clear of moving terrace door'. It includes an icon of a hand being pinched.</p>
40	<p>TAG: ANCHOR ROPE WARNING  P/N: 5455970  Location: Underside of anchor locker hatch</p>	 <p>A blue rounded rectangular label with white text that reads: <b>NOTE: ON OCCASION, YOU MAY HAVE TO CLEAR THE PILE OF ROPE FROM UNDER THE HAWSE PIPE TO MAKE ROOM FOR THE REMAINING ROPE.</b></p>
41	<p>TAG: GELCOAT DAMAGE NOTICE  P/N: 5450720  Location: Underside of anchor locker hatch</p>	 <p>A blue rectangular label with white text that reads: <b>NOTICE</b>  <b>Gelcoat damage may result if anchor is not properly secured.</b></p>
42	<p>TAG: NMMA CERTIFIED BADGE  P/N: 5455250  Location: Outboard of starboard transom steps</p>	 <p>A circular badge with a blue and white design. The outer ring contains the text 'MANUFACTURERS ASSOCIATION • NATIONAL MARINE MANUFACTURERS ASSOCIATION'. The center features the text 'NMMA CERTIFIED' with a red checkmark, and 'using ABYC standards' below it.</p>

<p>43</p>	<p>TAG: LEWMAR WINDLASS WARNING  P/N: 5455960  Location: Underside of anchor locker hatch</p>	
<p>44</p>	<p>TAG: AIR CONDITIONING PICKUP  P/N: 5435250  Location: Aft of the generator, under the sole hatch</p>	
<p>45</p>	<p>TAG: GENERATOR PICKUP  P/N: 5435210  Location: Aft of the generator, under the sole hatch</p>	
<p>46</p>	<p>TAG: WATER HEATER WINTERIZED  P/N: 5451840  Location: Water heater breaker on the AC Main Panel</p>	
<p>47</p>	<p>TAG: CA PROP 65  P/N: 9253280  Location: Steering wheel</p>	

# General Information

---

## Engine and General Specifications

L.O.A. with integrated platform .....	60'3" (18.36 m)
Beam .....	16'11" (5.16 m)
Draft (fully loaded, motors down).....	4'0" (1.22 m)
Clearance with Hardtop (from waterline).....	12'9" (3.29 m)
Approximate Dry Weight.....	57,500 lbs. (26,100 kg)
Fuel Capacity.....	700 U.S. gallons (2,649 L)
Water Capacity .....	150 U.S. gallons (568 L)
Holding Tank Capacity .....	86 U.S. gallons (325.5 L)
Deadrise at Transom .....	14°

## General Information

### Boat Information

Fill out the following information and leave it in your owner's manual. This information will be important for you and Tiara Yacht service personnel to know, if and when you may need to call Tiara Yachts for technical assistance or service.

Boat		
Model: Tiara Yachts EX 60	Hull Identification #:	
Purchase Date:	Delivery Date:	
Ignition Keys:	Registration #:	
Engines		
Port Engine	Center Engine	Starboard Engine
Make:	Make:	Make:
Model:	Model:	Model:
Engine Serial Number:	Engine Serial Number:	Engine Serial Number:
Lower Unit Serial Number:	Lower Unit Serial Number:	Lower Unit Serial Number:
Propellers		
Make:	Diameter / Pitch:	
Blades:	Other:	
Generator		
Make:	Model:	
Serial #:	kW:	
Dealer	Tiara	
Name:	Phone #:	
Phone #:	Representative:	
Sales Associate:	Address:	
Service Manager:		
Address:		

Tiara Yachts reserves the right to make changes and improvements in equipment, design and vendor supplied equipment at any time without notification.



# General Information

---

## Warranty & Warranty Registration Cards

The S2 Yachts, Inc., Limited Warranty Statement is included with this manual. It has been written to be clearly stated and easily understood. If you have any questions after reading the warranty, please contact Tiara Customer Relations.

S2 Yachts, engine manufacturers, and the suppliers of major components maintain their own manufacturer's warranty and service facilities. It is important that you properly complete the warranty registration cards included with your boat and engine(s) and mail them back to the manufacturers to register your ownership. This should be done within 15 days of the date of purchase and before the boat is put into service. A form for recording this information is provided at the beginning of this manual. This information will be important for you and service personnel to know, if and when you may need service or technical information.

The boat warranty registration requires the **Hull Identification Number (HIN)** which is located on the starboard side of the transom, just below the rub rail. The engine warranty registration requires the engine serial number(s). Refer to the engine owner's manual for the location of the serial number(s).

## Federal Boat Safety Act

All boat manufacturers are required by the Federal Boat Safety Act of 1971 to notify first-time owners in the event any defect is discovered "which creates a substantial risk of personal injury to the public." It is essential that we have your warranty registration card, complete with your name and mailing address, in our files so that we can comply with the law if it should become necessary.

## Product Changes

S2 Yachts is committed to the continuous improvement of our boats. As a result, some of the equipment described in this manual or

pictured in the catalog may change or no longer be available.

S2 Yachts **reserves the right to change standard equipment, optional equipment, and specifications without notice or obligation.** If you have questions about the equipment on your Tiara Yacht, please contact Tiara Customer Relations.

## Transferring the Warranty

For a transfer fee, S2 Yachts will extend warranty coverage to subsequent owners of Tiara Yachts models for the duration of the original warranty period. Please refer to the Tiara Limited Warranty Statement for the procedure to transfer the warranty. To take advantage of this program, notification of the change of ownership, including the new owner's name, address, and telephone number together with the appropriate fee, must be sent to Tiara Yachts within 30 days of the date of resale. Contact Tiara Customer Relations for details.

S2 Yachts will confirm, in writing, that the transfer of the warranty has taken place, after which the transferee will be treated as the original purchaser as outlined in the Tiara Limited Warranty Statement.

## Owner/Operator Responsibilities

### Registration and Documentation

Federal law requires all undocumented vessels equipped with propulsion machinery be registered in the state of principal use. A certificate of documentation will be issued upon registration. These registration numbers must be displayed on your boat. The owner/operator of a boat must carry a valid certificate of registration whenever the boat is in use. When moved to a new state of principal use, the certificate is valid for 60 days.

In order to be valid, the numbers must be installed to the proper specifications. Check with your dealer or state boating authority for numbering requirements. The Coast Guard issues the certificate of number in Alaska; all others are issued by the state.

### Insurance

In most states the boat owner is legally responsible for damages or injuries the boat causes. Responsible boaters carry adequate liability and property damage insurance for their boat. You should also protect the boat against physical damage and theft. Some states have laws requiring minimum insurance coverage. Contact your dealer or state boating authority for information on the insurance requirements in your boating area.

### Reporting Boating Accidents

All boating accidents must be reported by the owner or operator of the boat to the proper marine law enforcement authority for the state in which the accident occurred. Immediate notification is required if a person dies or disappears as a result of a recreational boating accident.

If a person dies or there are injuries requiring more than first aid, a formal report must be filed within 48 hours.

A formal report must be made within 10 days for accidents involving more than \$500.00 damage or the complete loss of a boat.

A "Boating Accident Report" form is located near the back of this manual to assist you in reporting an accident. For additional information, visit [www.uscgboating.org](http://www.uscgboating.org).

### Education

If you are not an experienced boater, we recommend that you and other people that normally accompany you enroll in a boating safety course. Organizations such as the

U.S. Power Squadrons, United States Coast Guard Auxiliary, state boating authorities, and the American Red Cross offer excellent boating educational programs. These courses are worthwhile even for experienced boaters to sharpen your skills or bring you up-to-date on current rules and regulations. They can also help in providing local navigational information when moving to a new boating area. Contact your dealer or state boating authority, or visit [www.uscgboating.org](http://www.uscgboating.org) for further information on boating safety courses.

### Required Equipment

U.S. Coast Guard regulations require certain equipment on each boat. The Coast Guard also sets minimum safety standards for vessels and associated equipment. To meet these standards some of the equipment must be Coast Guard approved. "Coast Guard Approved Equipment" has been determined to be in compliance with USCG specifications and regulations relating to performance, construction or materials. The equipment requirements vary according to the length, type of boat, and the propulsion system. Some of the Coast Guard equipment is described in section 9, Safety Information. For more information, visit [www.uscgboating.org](http://www.uscgboating.org) or contact your local marine dealer or retailer.

Some state and local agencies go beyond USCG regulations or impose similar equipment requirements on waters that do not fall under Coast Guard jurisdiction. Contact your dealer or local boating authority for additional information regarding the equipment requirements for that boating area.

### EPA Compliant Fuel System

EPA (Environmental Protection Agency) regulations require additional emissions related components for the fuel tank, fuel fill and fuel vent systems. It is unlawful to remove or intentionally defeat these emission related components.

# Pre-Cruise Checklist

---

## Fire Extinguisher Locations

This boat is equipped with a fire suppression system. See section 9, Safety Equipment, for more information.

There are five (5) fire extinguishers installed on this boat. Make sure they are fully charged at all times. Fire extinguishers are located inside the:

- starboard galley sink cabinet
- lower cockpit aft-facing seat base
- master stateroom port hanging locker
- VIP stateroom starboard hanging locker
- third stateroom starboard hanging locker

## Pre-Cruise Checklist

Before casting off on your voyage, ensure that proper safety gear is aboard. Familiarize yourself with all engine controls, steering operation, starting procedure, and how to interface with the helm multi-function displays (MFDs) and other instrumentation. Understand local regulations and waterways, and review the contents of this owner's manual before casting off.

### Before your voyage:

- Check the weather forecast. Decide if your planned cruise can be made safely.
- Make sure all required documents are onboard.
- Make sure all necessary safety equipment (items like running lights, spotlight, life saving devices, etc.) is onboard and operative. Refer to section 9, Safety Information, for additional information
- Each person onboard must have at least one personal flotation device. Check the U.S. Coast Guard standards for the correct type required for your boat.
- Make sure signal kits are onboard, in good operating condition, and not expired.

- Make sure all fire extinguishers are in position and in good operating condition.
- Make sure you have sufficient water and other provisions for the planned cruise.
- Leave a written message listing details of your planned cruise (Float Plan) with a friend ashore. Include a description of your boat, where you intend to cruise, schedule of your arrival in the cruising area, and when you expect to return. Keep the person informed of any changes in your plan to prevent false alarms. This information can tell authorities where to look and your boat type in the event you fail to arrive.
- Check the amount of fuel onboard. Observe the "rule of thirds": one third of the fuel for the trip out, one third to return and one third in reserve. An additional 15% may be consumed in rough seas.
- Check the water-separating fuel filters for water.
- Turn on the battery switches.
- Check for bilge water and for other signs of potential problems. Monitor for the scent of fuel fumes.
- Test the automatic and manual bilge pump switches to make sure the system is working properly.
- Have a tool kit and spare parts onboard (see below).

### Before starting the engines:

- Make sure the shift control is in NEUTRAL.
- Make sure the emergency engine stop lanyard is attached to the operator and the stop switch.

See section 10, Operation, for additional important information regarding how to safely operate your boat.

## Tool kit

Have a tool kit and spare parts onboard. **The kit should include basic tools:**

- Spark plug wrench
- Hammer
- Spark plug gap gauge
- Electrician's tape
- Screwdrivers
- Lubricating Oil
- Pliers
- Jackknife
- Adjustable wrench
- Vise grip pliers
- Needle nose pliers
- Wire crimping tool
- End wrench set
- Wire connector set

**The spare parts kit should include:**

- Extra light bulbs
- Spark plugs
- Fuses and circuit breakers
- Flashlight and batteries
- Drain plugs
- Engine oil
- Propellers
- Fuel filters
- Propeller nuts
- Fuel hose and clamps

## Propulsion Systems

### 1.1 General

Your Tiara boat is designed to be powered by dual diesel Volvo® IPS engines.

The engine manufacturer provides an owner's information manual. It is important you read and understand the information and become familiar with the warranty, operation and maintenance of the engine and drive systems.

CAUTION

**Engines and equipment in the engine room may be hot to the touch and might burn your skin. Care must be taken to avoid these areas while in the engine room.**

NOTICE

**DO NOT attempt to service boat systems unless you are familiar or qualified to do so. Do not use parts which are not designed for a marine application.**

NOTICE

**Use only the fuel recommended by the engine manufacturer. Use of old, contaminated fuel can cause the engine to malfunction or cause severe damage.**

### 1.2 Engine Lubrication

Use the oil type, grade, and level recommended by the engine manufacturer. Check the oil level before each use and use only the type specified by the engine manufacturer.

Monitor the oil level by checking the gauge on the helm or visually checking the oil level in the tank by using the reference marks on the tanks. Change the oil according to the engine manufacturer's recommendation.

Refer to section 3, Fuel Systems, and the engine owner's manual for additional information.

NOTICE

**Use only the oil recommended by the engine manufacturer, and monitor the oil level. Use of any other type of oil can cause severe damage or engine malfunction.**

### 1.3 Propellers

Repair or replace a propeller immediately if it has been damaged. A damaged propeller can cause vibration that can be felt in the boat and can damage the engine gear case.

Refer to the engine owner's manual for information on propeller removal and installation. We recommend having the propellers installed by your Tiara dealer or other qualified marine service facility.

### 1.4 Engine Instrumentation

The helm is equipped with the Volvo Glass Cockpit System by Garmin®, which includes two multi-function displays (MFD). The MFDs allow the operator to monitor all engine functions, operate the engine most efficiently, and prevent serious costly damage. The instrumentation is unique to the type of engine installed on your boat.

Interface with the MFDs via the touchscreens or the GRID (Garmin Remote Input Device) found on the helm seat armrest aft of the joystick. Refer to the Garmin owners manual for more information.

## Tachometer

The tachometer displays the speed of the engine in revolutions per minute (RPM). This speed is not the boat speed or the speed of the propeller.

 **NOTICE**

**DO NOT exceed maximum recommended engine RPM. Exceeding, maintaining or coming close to maintaining maximum RPM can reduce engine life.**

## Speedometer

The speedometer indicates the speed of the boat in miles per hour (MPH).

## Temperature Warning

The temperature warning indicates the temperature of the engine. A sudden increase in the temperature could indicate an obstructed water inlet or an impeller failure.

 **NOTICE**

**Continued operation of an overheated engine will cause severe engine damage. If the engine overheats, shut off the engine, investigate the problem and correct it.**

## Fuel Gauge

The fuel gauge indicates the approximate fuel level in the fuel tank(s). This gauge is a relative indication of the fuel supply available; it is not a calibrated instrument.

## Voltmeter

The voltmeter displays the voltage for the batteries and the charging system. The normal voltage for a fully charged battery is 12.6 or 24.5 volts with the engine(s) off and 13 to 14.5 or 16 to 28 volts with the engine(s) running.

## Hourmeter

The hourmeter keeps a running total of engine hours of operation.

## Trim Gauge

The trim gauge monitors the position of the trim tabs. The lower range indicates the trim position. Trim is used to adjust the hull angle while operating your boat on plane. Refer to the engine owner's manual for more information on the operation of the trim tabs.

## Engine Alarms

An audible alarm system mounted in the helm area monitors selected critical engine systems and functions. The alarm will sound if one of these systems begins to fail. Refer to the engine owner's manual for information on the alarms installed with your engine.

 **CAUTION**

**If an engine alarm sounds, shut off the engine, investigate the problem and correct it.**

## 1.5 Seakeeper Gyro Stabilization System (optional)

To operate the optional Seakeeper® Gyro Stabilization System, if installed, use the Garmin OneHelm display or the control panel installed in the third stateroom electrical cabinet. Refer to section 4, Electrical Systems, and the Seakeeper user manual for more information.

## Helm Systems

### 2.1 General

The helm controls consist of the engine throttle with shift and integrated trim tab controls, steering wheel, and joystick control.

The manufacturer of each control component provides an owner’s manual with its product. It is important that you read, understand, and become familiar with the proper care and operation of all control systems.

**CAUTION**

Service or repairs to equipment inside your console should be performed by your Tiara Dealer or other qualified marine repair technician. Failure to do so could result in damage to equipment used to safely operate the boat.

### 2.2 Helm Access

The helm stations are hinged at the top to provide service access to the helm equipment by a qualified electrician or Tiara Yachts dealer. Do not open the helm station with engines running; accidental engagement of shift and throttle levers can occur.

**WARNING**

**LOSS OF CONTROL AND UNSAFE BOAT HAZARD**

Improper securing of the helm is hazardous and can cause death or serious injury from sudden loss of control. Make sure the helm is secure before getting underway and when transporting the boat.

**CAUTION**

Service or repairs to equipment inside your console should be performed by your Tiara Yachts dealer or other qualified marine repair technician. Failure to do so could result in damage to equipment used to safely operate the boat.

### 2.3 Engine Monitoring Displays

The helm is equipped with engine-monitoring, multi-function displays (MFDs). Use the MFDs to monitor all engine functions (including fuel level and motor trim), operate the engines most efficiently, and prevent serious, costly damage. The exact instrumentation is unique to the type of outboard engines installed on your boat. Refer to your engine package owner’s manual for information, features, and operation of this device.

Interface with the Garmin® MFDs via the touchscreens or the GRID (Garmin Remote Input Device) found aft of the joystick on the outboard helm seat armrest. Refer to the Garmin owners manual for more information.

### 2.4 Engine Throttle and Shift Controls

The Volvo e-Key control ignition panel, located outboard of the steering wheel, allows you to engage the engines with a single RFID key fob.



Volvo® e-Key control panel



Volvo® e-Key

The specific shift and throttle controls installed on this Tiara Yacht will depend on your boat's engine package. Refer to your engine package owner's manuals for specific information about the controls installed on your boat.

The helm is designed for a binnacle-style control with two throttle levers. Each throttle has a position for neutral (straight up and down), forward position (first detent forward of neutral) and reverse position (the first detent aft of neutral). Advancing the control lever beyond the shift range will advance the throttle, forward or reverse.



## CAUTION

**To avoid possible injury or engine damage when shifting:**

- **Pause in neutral before shifting from FORWARD to REVERSE, or REVERSE to NEUTRAL.**
- **DO NOT shift into reverse while the traveling forward at speed.**
- **Keep the area around the shifter control clear of obstructions.**

### 2.5 Starting Your Engines

Before starting your engines, be sure that you have read your engine owner's manual and performed all the maintenance and safety checks listed in the Pre-Cruise Checklist section of this manual.

#### Before starting the engines:

1. Switch ON all breakers except the OIL CHANGE PUMP breaker on the Master DC Panel in the engine room.

2. Turn ON all breakers on the DC distribution panel with the exception of the waste pumpout breaker (if equipped).
3. Press ON the PORT ON, STBD ON, and HOUSE/GEN ON buttons on the DC Power screen of the power-up panel, installed on the port helm console. (See chapter 4 for information about battery voltage levels.)

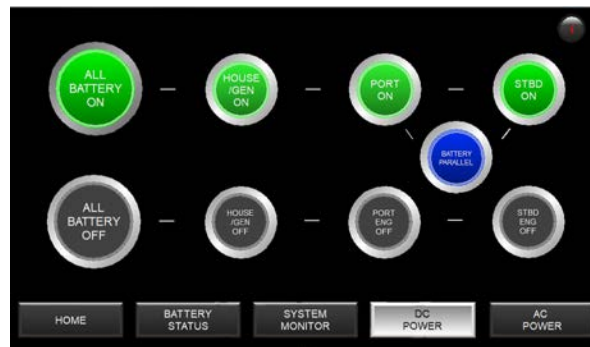

*DC Power screen of power-up panel*

4. Open all hatches to the bilge area(s). Investigate and remedy any fuel vapors that are detected.
5. Check the engine and drive unit oil levels.
6. Check the engine coolant levels.
7. Open the engine raw water seacocks.
8. Open the engine fuel supply and return valves. The fuel valves are located in the engine room.



## CAUTION

**Prior to starting engines, ensure fuel supply and return valves are in the open position. A fuel valve is open when it is parallel to its associated fitting. Failure to open all fuel valves will damage the engine.**

9. Use the ENG ROOM FAN button on the System Monitor screen of the power-up panel or the BLOWER button at the



helm to turn on the engine room blower(s). Run the blower(s) for five minutes prior to starting the engines.

### To start the engines:

1. Make sure the engine control levers are in the neutral position.
2. Hold the Volvo e-Key in front of the Volvo e-Key control panel to unlock the system. A sound confirms the system is unlocked.
3. Press the IGNITION buttons on the e-Key control panel to switch the ignitions ON. Make sure the green light on the IGNITION buttons indicates the ignitions are ON.
4. To start, press each of the two START/STOP buttons.
5. Check the voltage and amperage for each battery bank using the battery status screen on the power-up panel. If the voltage is below 12 or 24 volts, or above 15 or 30 volts, stop the engines and investigate the cause before proceeding.
6. Monitor all engine-related data on the helm multi-function displays. If anything seems abnormal, stop the engines and investigate the cause before proceeding.
7. Let the engines run at idle for several minutes before leaving the slip.

## 2.6 Automatic Fire Suppression System

The Fireboy fire suppression system protects the generator compartment in case of fire. To manually discharge the fire suppression system, remove the pin and pull the red handle of the fire system manual discharge located under the helm seat.

The Fireboy panel, installed in the port helm glovebox, indicates if the system is charged or discharged. If the system is discharged, an audible alert will sound.

After the fire suppression system discharges, use the ENG ROOM FAN button on the System Monitor screen of the power-up panel, or

the BLOWER button at the helm, to run the engine room blower(s) for five minutes before opening the generator. Reset the system using the override button on the generator status panel. Do not operate the boat until the fire suppression system has been recharged by your Tiara Yachts dealer or other qualified professional.



*Fire system manual discharge pull*



*Fire suppression system status panel and override button*

For additional important information, see section 9, Safety Information, and the automatic fire suppression system owner's manual.

## 2.7 Steering System

Your Tiara Yacht is equipped with a steer-by-wire steering system. Refer to your steering system owner's manual for more information.

Steer your boat using the steering wheel, joystick control, or engine controls. For detailed information, see the engine owner's manual.

### Steering Wheel Driving

Steering wheel responsiveness can be quick. Aggressive steering can turn and heel the boat dramatically. While underway, maneuverability is highly responsive to the skipper's command.

Tilt the steering wheel to a comfortable position by pushing the tilt catch on the 6 o'clock position of the wheel base.

The steering wheel sends a digital signal to the Electronic Vessel Control (EVC) computer, which sends commands to the IPS drives to rotate accordingly. The steering wheel will rotate in either direction limitlessly, but a digital stop has been encoded. No matter how many turns the wheel is given in either direction, the drives will stop rotating once the digital stop point has been realized. At higher engine speeds the steering turning degree is more controlled: that is to say, the angles of turning will be limited at higher engine revolutions (RPMs). At higher engine speeds a built-in resistance will interface with the wheel, giving the helmsman the analog feel of force when turning.

The rudder angle indicator on the Multi-Function Displays (MFDs) shows an approximation of the drive angle.

When the ignitions are turned off, the IPS drive units automatically center.

### 2.8 Volvo Interceptor Boat Trim System

The Volvo Penta Interceptor System boat trim system contributes to more straightforward, safer and more comfortable driving. This patented system uses vertical interceptor blades that are made from corrosion-free materials and require virtually no maintenance; the composite material does not cause any galvanic corrosion, and therefore doesn't require protective anodes that have to be replaced. The interceptor blades are programmed to cycle into a self-cleaning mode that minimizes marine growth.

When the interceptor system is deployed, the blades lower into the water vertically and create hydrodynamic pressure which produces lift to the stern, enabling the boat to accelerate to the plane smoothly for a perfect running attitude. The result is less friction with the water and therefore less fuel required to power the boat at speed. Engage with the system using the MFDs and the helm throttle controls.

The system offers three preprogrammed modes designed to provide optimal operation of your Tiara:

- **Auto Trim and List** provides automatic correction of the boat's trim and list, optimizing the performance in all conditions.
- **Auto Trim, List and Coordinated Turn** adjusts the list in turn to keep the boat more upright in sharp turns and allow for a true turn so passengers feel no sideways forces during the turn.
- **Active Ride** utilizes interceptors to effectively diminish pitch and roll motion by up to 60% at cruising speeds, reducing the risk of seasickness.

To operate the system manually, press the button on the back of the throttle and use the trim buttons on the front of the throttle.

For more information, see your Volvo Interceptor owner's manual.

### 2.9 Compass

The compass is located forward of the helm. To adjust the compass, read the instructions on 'Compass Compensation' provided with this manual. The compass cannot be adjusted accurately at the factory; it must be compensated for the influence of the electrical equipment and electronics unique to your boat. The compass should be adjusted by a professional after all electronics and additional electrical accessories are installed and before operating the boat.

## 2.10 Joystick

The Volvo IPS joystick is located on the out-board helm armrest. Before using this system, carefully review the owner's manual for important safety warnings and operating instructions.

The joystick control may be used in place of the steering wheel and shift/throttle levers to control the boat at low speed and during docking maneuvers, or to steer the boat while underway at speed. With its intuitive operation, the joystick allows the operator to move the boat at various slow speeds in any direction, spin the boat on its own axis, and move the vessel sideways. See your engine package owner's manual for more information.



*Volvo joystick*



Fuel Systems

3.1 Fuel System

**! WARNING**

Failure to follow proper fuel system priming procedures will result in damage to the fuel management system. The fuel system should be serviced by qualified personnel only. In the event of absolute fuel depletion to the engines, contact a certified technician.

DO NOT remove the anti-siphon valves from the system. Anti-siphon valves prevent fuel from flowing into the bilge should a fuel hose or fitting leak. If the valve becomes clogged, clean and reinstall or replace it.

Fuel Tank

The fuel tank holds approximately 700 gallons (2,649 liters) of fuel. Fuel pick-up tubes are positioned in the tank to achieve optimum fuel usage, fuel line routing, etc. At certain speeds and hull trim angles, the fuel supply at the withdrawal tube can increase or decrease accordingly. Be extremely careful when attempting to operate the boat when low on fuel. Though some fuel may be in the tank, the trim angle of the boat may cause the fuel to flow away from the pickup tubes.

Fuel Gauge Senders

The fuel gauge senders are more accurate when the boat is stationary and level. Because of the change in attitude when the boat is underway, variations in gauge readings can occur. This system is a relative indication of the available fuel supply and not a calibrated instrument.

Fuel Fills

Diesel fuel fills are located on each gunwale and are labeled DIESEL. Both the starboard and port fuel fills feed the boat's single tank.



*Diesel fuel fill (typical)*

**! DANGER**

**FIRE/EXPLOSION HAZARD**  
 Fuel vapors are highly explosive when exposed to open flame or spark, resulting in death or serious injury.

- Stop engines before fueling.
- DO NOT smoke or allow open flames or sparks nearby, within 50 ft (15 m) of the fueling area.
- Maintain contact between fuel nozzle and fuel tank fill to prevent electrostatic spark. DO NOT use a plastic funnel.
- Fill in an open area.

**! DANGER**

**BURN HAZARD**  
 Fuel floating on water which is ignited can cause death or serious injury. Fuel will float on top of water and can burn. If the boat is abandoned, swim upwind, far enough to avoid fuel that can spread over the surface of the water.

**WARNING**

**Fuel is flammable. Do not smoke. Never fill the tank while the engines, blowers, generator, or other equipment is operating. Do not fill near open flames.**

**WARNING**

**Be sure that the fuel fill is in contact with the fuel nozzle to prevent any static sparks during the fueling operation. Failure to heed this warning could result in a static electricity charge that could lead to injury, damage, or death.**

During refueling, the tank will vent out at both the fuel fill plate and the vent located on the side of the hull. **Note:** There should not be any residual fuel at the vent but there could be residual fuel at the deck fill plate. Do not block or restrict either of these vents.

**CAUTION**

**A no-spill vent system is used so that fuel will not spill out of the vents when filling; however, fuel will exit the fuel fill pipe if overfilling occurs. When filling the fuel tank listen carefully for fuel filling up in the fill pipe.**

Try not to spill fuel. If fuel is spilled, wipe up all traces with dry rags and immediately dispose of the rags properly onshore. DO NOT allow fuel to stay on the finish of the boat, as discoloration and damage to trim can occur. Avoid fueling at night, except under well-lighted conditions. Also, monitor the fuel level to avoid overfilling.

**Fueling Instructions**

1. Make sure the generator is off.
2. Turn OFF all battery switches using the power-up panel (installed on the port helm console).
3. Make sure your boat is securely moored.
4. Close all port lights, hatches, and doors.
5. Estimate how much fuel will be needed to fill the tank.
6. Open the fuel fill by turning it counter-clockwise.
7. Insert the fuel nozzle into the fuel fill and dispense the fuel until the tank is full. Verify that the tank is full by reading the fuel gauge and/or by the sound of the fuel fill filling up. If your tank takes significantly more fuel than expected, investigate the cause immediately.
8. After fueling, screw the cap on in a clockwise direction until the cap is seated. If the cap is lost or damaged, replace only with original equipment; contact Tiara Yachts Customer Relations or your Tiara Yachts dealer.
9. Wash the areas around the fuel fill(s) to help reduce discoloration of the fiberglass or striping. Use only the fuel recommended by the engine manufacturer. Refer to the engine owner's manual for additional information.
10. Check the mechanical space and bilge areas for fuel odors. If you smell fuel, do not start the engines or other electrical equipment. Investigate and correct the problem, and completely ventilate the bilge area before proceeding.

**WARNING**

**Do not start the engines until you are sure there are no fuel fumes in the bilge or engine compartment of your boat. Fuel vapors are explosive and may ignite during engine start-up, causing serious injury or death.**

**! CAUTION**

To reduce the risk of fire, investigate all fuel odors immediately. Do not start the engines, generator or other electrical equipment if fuel odors are present.

If fuel is accidentally added to any other tank, DO NOT attempt to pump the fuel out; these systems are not designed to pump fuel. Fuel must be removed by qualified personnel only. Fuel in other systems will also require replacement of that system and/or multiple components.

**! WARNING**

The Federal Water Pollution Control Act prohibits the discharge of oil or oily waste into or upon the navigable waters of the United States, or the waters of the Contiguous Zone, or which may affect natural resources belonging to, appertaining to, or under the exclusive management authority of the United States, if such discharge causes a film or discoloration of the surface of the water or causes a sludge or emulsion beneath the surface of the water. Violators are subject to substantial civil penalties and/or criminal sanctions, including fines and imprisonment. Report all discharges to the USCG National Response Center at 1-800-424-8802 or to your local U.S. Coast Guard office by phone or VHF radio, Channel 16.

**! NOTICE**

Be careful not to spill any fuel outside the boat into the water. If you do, clean up the fuel immediately in the manner prescribed by your local regulations.

**! NOTICE**

To prevent damage to your fuel system, use only a quality grade of fuel as recommended by the engine manufacturer. Do not use a fuel which contains harsh additives. Damage to your fuel system as a result of using these fuels will not be covered by your warranty.

**Fuel Water Separating Filters**

Fuel filters are located on the forward engine room bulkhead, to port and starboard. There is one water-separator type filter for each engine fuel line. Check filters for water frequently to ensure an adequate supply of clean, dry fuel to the engines. The filter elements should be changed every 500 engine hours, at every other oil change, once a season, or if a power loss is noticed, whichever comes first.



*Fuel water separating filter (typical)*

Turn off all electrical switches before servicing the fuel system and DO NOT drain any fuel into the bilge. Check all fuel lines and fittings for leaks before and after starting the engines, and after any fuel system service.

Refer to the engine and filter owner's manuals for additional information, and see the end of this section for more fuel system maintenance information.

### 3.2 Diesel Generator Fuel System

The engines and generator share the same fuel tank. The generator fuel withdrawal tube is designed to stop drawing fuel when the tank is one quarter (1/4) full with the boat sitting at rest. Cruising attitudes and sea conditions may affect when this occurs. The system was designed in this manner to allow for a margin of safety so the generator does not deplete the engines' fuel supply.

Make sure the fuel valve on top of the fuel tank is in the ON position before attempting to start the generator.

#### Generator Fuel Filter/Water Separator



*Generator water-separator fuel filter*

The generator water-separator fuel filter is installed in the port forward engine room. The fuel filter has a sediment bowl that must be inspected for water frequently to ensure an adequate supply of clean, water-free fuel is supplied to the engine. Inspect the filter periodically and change the element as needed.

### 3.3 Fuel System Maintenance

Spray the valves, fuel tank gauge sender and ground connections with a metal protector.

Inspect the fuel fill cap o-ring seals frequently and lubricate with petroleum jelly or silicone grease. The o-ring seal prevents water from entering the fuel system through the fuel fill cap. If the o-ring is damaged, or you suspect it is damaged, replace it.

Do not allow the boat to sit unused for an extended period with the fuel tank less than 3/4 full. Changes in temperature and weather conditions can cause condensation in the fuel tank. Your Tiara Yachts dealer or the engine manufacturer can provide additional information on fuel degrading and fuel stabilizers recommended for your engine.



## DANGER

### FIRE / EXPLOSION HAZARD

Fuels are extremely flammable and highly explosive under certain conditions. **DO NOT** smoke or allow open flames or sparks nearby when inspecting the fuel system. Check fuel lines and all system components (filters, primer bulbs, clamps and connections) frequently for leaks, damage or deterioration. If you suspect damage, replace as necessary. Surface cracking on a hose indicates wear—replace it.

Improper storage of fuel at marinas, limited boat usage, etc., can cause fuel to become contaminated. Periodically, it may be necessary to pump accumulating water and contaminated fuel from the bottom of the fuel tank. If the fuel system on your boat becomes contaminated, contact your dealer or marina for assistance.

Diesel engine operation requires a good supply of clean, water-free diesel fuel. Algae



can grow in the accumulated water in the diesel fuel tank. This will normally occur in warm climates. Adding a high-quality diesel fuel additive containing an algaecide may be required periodically to control algae in your diesel system, depending on your boating area. Contact your Tiara Yachts dealer or engine manufacturer for additional information regarding fuels and additives.

---

Operator Notes

Ruled area for operator notes consisting of 25 horizontal lines.

Electrical Systems

4.1 General

The electrical systems in your Tiara Yacht have been developed to supply all the boat’s electrical needs at the dock, at anchor, and underway. While this manual will not attempt to describe all of the electrical engineering that went into the system, a basic understanding will help assure trouble-free operation.

Your boat is equipped with DC and AC electrical systems. The DC system draws current from onboard batteries. The AC system can draw current from either dockside (shore power) outlets or the generator.

Electrical schematics are included in Appendix G to assist technicians in the servicing of the electrical systems. Tiara recommends you take your boat to an authorized Tiara Yachts dealer for service or installation of additional electrical equipment. Tiara reserves the right to modify or update the electrical system at any time without notice to the consumer or obligation to make updates to boats built prior to the change.

**WARNING**

**All electric system service work should be performed only by an authorized Tiara Yachts dealer or other qualified marine electrical service facility. Failure to heed this warning may result in personal injury or death.**

4.2 Power-Up Panel

Your Tiara is equipped with a power-up panel, installed on the port helm console, which provides easy-to-use controls for a variety of systems and components.

Tap the information (‘i’) icon in the upper right-hand corner of every screen for additional information.

**The Battery Status screen** allows you to monitor the state of charge of the house battery, port engine battery, and starboard engine battery.



Battery Status screen

**Buttons on the System Monitor screen** allow you to check the levels of the fresh-water and waste tanks; test the bilge alarm; turn on the engine room fan and engine room lights; disable the transom trunk lift actuators (to prevent access to the trunk); and activate the waste tank overboard discharge pump (in boats equipped with an optional overboard discharge seacock). See section 5, Plumbing, for more information before activating the pump.

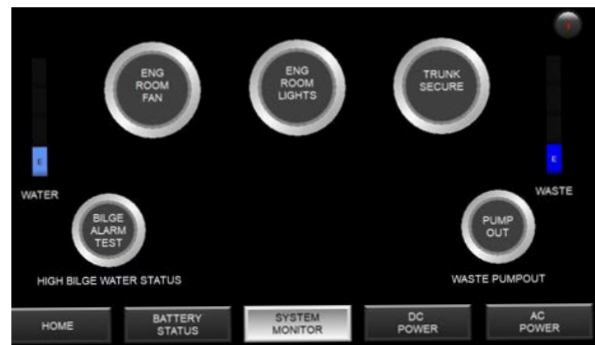

System Monitor screen

The **DC Power screen** allows you to turn the house battery and port and starboard engine batteries on and off. To turn the batteries on or off, press and hold the appropriate button(s) for at least one second.

If any of the battery buttons are orange, indicating low voltage, charge the battery using shore or generator power before starting.

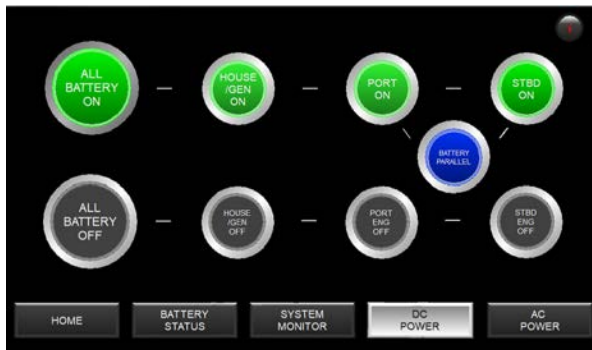

*DC Power screen*

The **AC Power screen** allows you to select and connect to shore power or generator power; monitor the available AC voltage and current draw; and start or stop the generator. See Power Source Selection, later in this chapter, for more information.

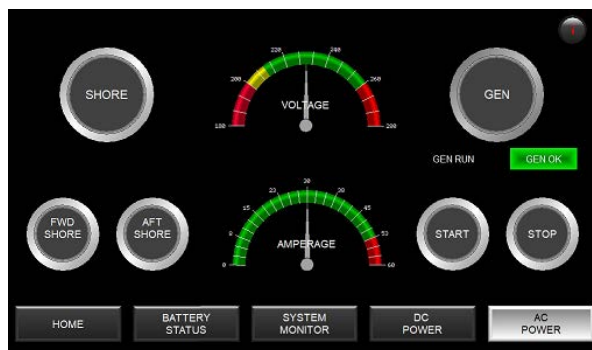

*AC Power screen - Shown with optional FWD*

### 4.3 24V DC System

The DC power system on your boat consists of three 24VDC battery banks. These banks are created by wiring 12VDC batteries in series. The three banks are divided into a house bank and a bank for each of the engines. The house bank provides power to

all DC-powered components and generator starting. The 12VDC battery bank for your boat has been designed to provide optimum performance for engine starting and house loads. The batteries are located in the engine room. Refer to the engine owner's manual for information about the circuit breakers installed on your engines.

The house battery bank supplies power to all the boat's comfort and convenience functions such as lighting, pumps, actuators, stereo, and electronics. The house bank should also be used to power any aftermarket electronics.



## CAUTION

**All aftermarket electrical components should be installed by your Tiara Yachts dealer or other qualified marine electrical service facility. They must be installed to be powered from the house battery bank only. The engine battery banks are strictly reserved for engine power only.**

### Battery Charging

The 12-volt DC system batteries are charged by the engine charging system or by the battery charger(s) when connected to shore power or operating the generator.

Your boat is equipped with one 120 amp battery charger with built-in 3000 watt inverter to charge the house and engine batteries. The charger is calibrated to provide the proper charge levels for each specific battery. Changing the battery specification will require recalibration of the battery chargers. The battery charger is located in the engine room.

It is important that your batteries be kept in a state of full charge as much as possible. Fully charged 24V batteries will indicate a voltage in excess of 28 volts with no load, or while being charged. Consult the DC voltmeter on the battery status screen of the power-up panel, installed on the port helm console.

Prolonged periods of discharge will cause the batteries to deteriorate rapidly, and will result in their inability to hold a charge for the expected amount of time. This can happen easily if excessive DC loads (such as lights) are left on while the battery charger is off.



*Battery charger (typical)*

At dockside, when the boat is connected to shore power, the battery chargers maintain the charge on the engine and house batteries. When operating the generator, the engine and house battery chargers must be on to maintain charge to the batteries.

Leave your boat connected to shore power with the battery chargers ON when leaving for any extended period of time. Make sure the BATTERY CHARGER/INVERTER and BATTERY CHARGER breakers on the Master AC Panel and the ENGINE BATTERY CHARGER breakers on the Master DC Panel are ON. Both Master Panels are located in the engine room.

### 12-Volt Power System

Power to the boat's 12VDC components is provided via buck boost transformers mounted on either side of the Master DC panel in the engine room. These transformers convert 24VDC to 12VDC. The transformers are automatic and need no monitoring or switching.

### DC Distribution

To turn the battery switches off and on remotely, use the power-up panel on the port helm console. A circuit breaker on each engine protects the engine ignition systems and gauges. Refer to the engine owner's manual for information about your engines. See section 4.2 for more information regarding the power-up panel.

When the batteries are turned off, all DC power to the rest of the boat (including the high water alarm) is disconnected. **The only exceptions** are the three automatic bilge pumps. Shutting OFF the yellow main battery switches will not disconnect power to bilge pumps.

Power from each engine battery supplies the respective yellow engine battery switch (STBD, PORT) while power from the house battery supplies power to the yellow HOUSE battery switch on the Master DC Panels, located in the engine room. **The yellow main engine and house switches should only be used as an override in the event of a failure of the power-up panel system.**

### DC Main Breakers

There are a number of breakers on the Master DC box panels, located in the mechanical space, that need to be switched ON for their corresponding components to operate.

For all practical purposes, all breakers on the Master DC Panels should be left in the ON position when the boat is in use **except the OIL CHANGER breaker.**

**Horn breaker:** Supplies power to the helm horn button.

**Engine Room Blower breakers:** Supply power to the BLOWER button on the helm.

**Cablemaster breaker:** Supplies power to the Glendinning Cablemaster shorepower cord retraction reel.

**Trunk Lift (Port and Stbd) breakers:** Supply power to the TRUNK LIFT UP and DOWN buttons installed inboard of the starboard transom steps.

**Trim Tab breaker:** Supplies power to the trim tab panel on the helm.

**Livewell breaker (on boats featuring the Adventure Module):** Supplies power to the livewell.

**House and Engine Battery Charger breakers:** Protect the charge circuits from the battery chargers.

**Wiper Port breaker:** Supplies power to the PORT WIPER and HI/LO buttons on the helm.

**Wiper Stbd breaker:** Supplies power to the STBD WIPER and HI/LO buttons on the helm.

**TV Lift breaker:** Supplies power to buttons used to lift and lower the galley TV.

**Ignition Acc Relay breaker:** Supplies power to the Volvo Accessory Power Relay. This breaker must be on for the buck boost transformers and the terrace to function properly.

**Gyro Control breaker:** Supplies power to the Seakeeper gyro stabilizer, if the optional gyro is installed.

**Gyro Pump breaker:** Supplies power to the optional Seakeeper gyro controller, if installed.

**Table Lift breaker:** Supplies power to the button that controls the breakfast bar, if equipped.

**Cabin Main breakers:** Supply power to the DC distribution panel.

**Washdown Pump breaker:** Supplies power to the pressure-demand raw water wash-down pump. The pump is also protected by

an automatically resetting breaker on the pump motor. Refer to section 5, Plumbing Systems, for more information.

**Sunroof breaker:** Supplies power to the power sunroof controller.

**Bilge Fwd breaker:** Supplies power to the forward bilge pump located under the cabin atrium sole.

**Bilge Mid breaker:** Supplies power to the mid bilge pump located in the forward engine room.

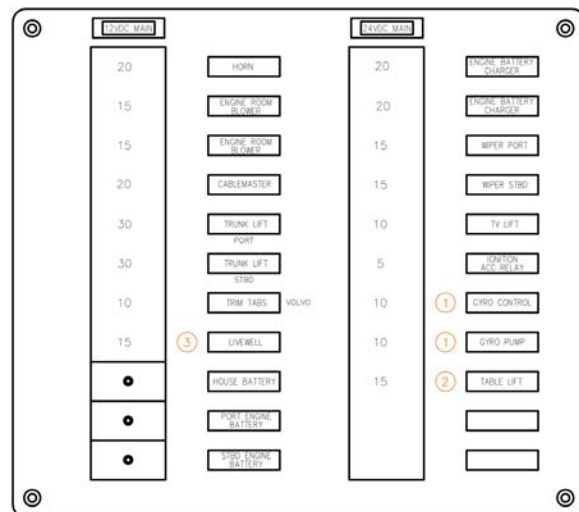

Master DC panel

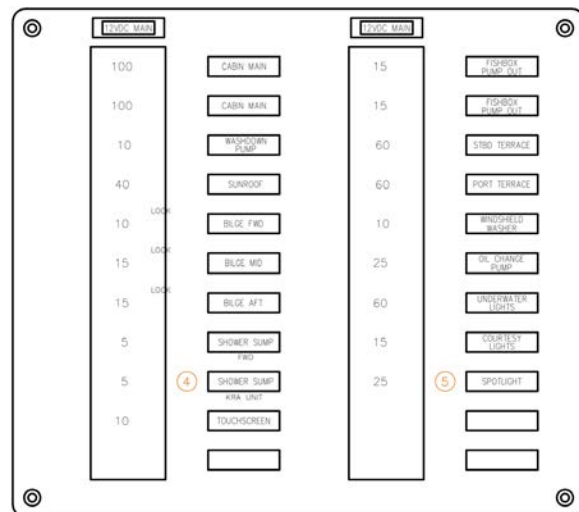

Master DC panel 2

**Bilge Aft breaker:** Supplies power to the aft bilge pump located in the aft engine room.

**Shower Sump (Fwd) breaker:** Supplies power to the shower sump, located in the bilge below the cabin hallway sole.

**Shower Sump (KRA Unit) breaker (optional):** Supplies power to the sump box that removes condensate from the optional coiled cooler box refrigeration unit (KRA).

**Touchscreen breaker:** Supplies power to the power-up panel installed on the port companionway bulkhead.

**Fishbox Pumpout breakers:** Supply power to the FLOOR BOX (PORT and STBD) buttons installed on the port alfresco cockpit switch panel.

**Terrace Door (Starboard and Port) breakers:** Supply power to the terrace up/down buttons in the aft cockpit.

**Windshield Washer breaker:** Supplies power to the port and starboard windshield washer helm buttons.

**Oil Change Pump breaker:** Supplies power to the optional generator oil changer system. See oil changer owner's manual for details.

**Underwater Lights breaker:** Supplies power to the underwater lights. Operate the underwater lights using the Garmin OneHelm display, and only do so when the boat is in the water, since the lights rely on water for cooling.

**Courtesy Lights breaker:** Supplies power to switches that control courtesy lights and exterior indirect lights.

## 4.4 12-Volt DC Helm Switches

There are a number of DC buttons on the helm. For any of the buttons to function, the corresponding circuit breaker on the Master

DC Panel (in the engine room) or the DC distribution panel (in the third stateroom electrical cabinet) must be switched ON.

**Horn button:** Activates the boat horn.

**Nav/ANC Lights button:** Activates the red and green navigation (or 'running') lights and the all-around light on the masthead. Use when operating the boat at night or when visibility is reduced.

 <b>CAUTION</b>
<p><b>Always make sure the aft navigation light is visible. Never obstruct or block the visibility of any of the navigation (NAV) lights.</b></p>

**Panel Dimmer Up/Down button:** Supplies power to the helm console LED accent lighting button.

**ACC buttons:** These unassigned buttons are reserved for user-installed accessories. DO NOT install a component with an operating current that exceeds 10 amps (12VDC).

**Sunroof Close/Open buttons:** Open and close the sunroof.

**Port and Starboard Wiper Hi/Lo/Off buttons:** Activate the windshield wiper and select fast or slow windshield wiper speeds.

**Port and Starboard Wiper Washer buttons:** Spray fresh water on the windshield when the selected wiper is on, using the boat's freshwater system. The freshwater pump breaker on the DC distribution panel must be on for the washers to spray.

**Antennas Down/Up buttons:** Raise and lower the VHF and AM/FM antennas.

**Terrace Door button:** Supplies power to the terrace door up/down buttons in the aft cockpit.

**Windlass Deploy/Retrieve buttons:** Deploy and retrieve the anchor. Refer to the windlass information in section 7, Exterior Equipment.

**Aft Bilge, Mid Bilge, and Fwd Bilge buttons:** Activate the respective aft, mid, and forward bilge pumps. If a pump activates automatically, the bilge pump button will light up.

**Blower button:** Activates the engine room exhaust blower.

#### 4.5 DC Distribution Panel

##### DC Volt Meter

Periodically monitor the voltage (charge) on the house battery from the Battery Status screen on the power-up panel, located on the port helm console. Do not operate the DC system if the voltage is lower than 10.5V or higher than 13V.



*Battery Status screen, power-up panel*

##### DC Distribution Panel

The breakers on the DC distribution panel, located in the third stateroom electrical cabinet, must be switched ON for the corresponding components to function.

**Cabin Lights 1, 2 and 3 breakers:** Supply power to cabin light switches.

**Courtesy Lights breaker:** Supplies power to the switches that control interior indirect lighting and exterior pop-up lights.

**Nav/Anc Lights breaker:** Supplies power to the NAV/ANC LIGHTS helm buttons.

**Engine Room Lights breakers:** Supply power to the engine room light switches.

**Footrest Actuator breaker:** Supplies power to the FOOTREST switch installed outboard of the helm seat cushion.

**Sun shade breaker:** Supplies power to the SUNSHADE OPEN/CLOSE buttons on the switch panel installed outboard of port alfresco cockpit switch panel.

**Blinds breakers:** Supply power to all of the boat's electronic window blinds.

**Stereo breakers:** Supply power to the stereo control panels installed in the foredeck, cockpit, salon, master stateroom, and VIP stateroom.

**Amplifier breakers:** Supply power to the stereo amplifiers.

**Vacuum Pump breakers:** Supply power to the head vacuum flush pump. Must be switched ON in order for the head vacuum flush to function.

**Fresh Water Pump breakers:** Supply power to the fresh water pump(s). Must be turned ON in order to use the shower, sinks, head, windshield washer, and other freshwater system components. Turn OFF when the boat is unattended.

**Head Fan breaker:** Supplies power to the head exhaust fan motor.

**Waste Pumpout breaker (optional) :** Supplies power to the overboard waste discharge pump, if installed. **This breaker should be kept OFF at all times** unless pumping waste overboard in a legal raw sewage discharge area. See section 5, Plumbing Systems, for more information.



**Power Helm Seat breaker:** Supplies power to the power helm seat buttons installed outboard of the helm seat cushion.

**Door Actuator breaker:** Supplies power to the starboard pilot house door buttons, installed on the starboard exterior bulkhead forward of the door and outboard of the starboard helm console.

**Enclosure breaker:** Supplies power to the aft galley bulkhead retracting glass window controller.

**Windlass Control breaker:** Supplies power to the WINDLASS DEPLOY and RETRIEVE helm buttons.

**Electronics breakers:** Supply power to the electronics at the helm.

**Refrigerator breakers:** Supply DC power to the galley refrigerator/freezers.

**Cockpit Refrigerator breaker:** Supplies DC power to the aft cockpit refrigerator.

**USB Chargers breaker:** Supplies power to the USB chargers installed throughout the boat.

**Hardtop TV Actuator breaker (optional):** Supplies power to the TV RAISE/LOWER buttons installed on the port alfresco cockpit switch panel (if equipped with cockpit TV).

## 4.6 Seakeeper Gyro (optional)

Your boat may be equipped with an optional Seakeeper<sup>®</sup> gyroscopic stabilization system, in which case the remote gyro control panel will be installed in the third stateroom electrical cabinet. You may also control the gyro from the Garmin OneHelm<sup>™</sup> display. Please refer to the Seakeeper owner’s manual for information about the operation of this system.

## 4.7 AC System

Either shore power or generator power may be used to supply AC current to the Master AC Panel in the engine room. All AC current is distributed to AC components through individual 120V (230V for CE) circuit breakers located on the AC distribution panel in the third stateroom electrical cabinet.

**DANGER**

**ELECTROCUTION, FIRE OR EXPLOSION HAZARD**

Contact with live wires or working on an energized electrical system can cause electrocution. It can also cause sparks, resulting in fire and/or explosion. Both cases will result in death or serious injury. **DO NOT** work on an energized system or allow unqualified personnel to work on the system.

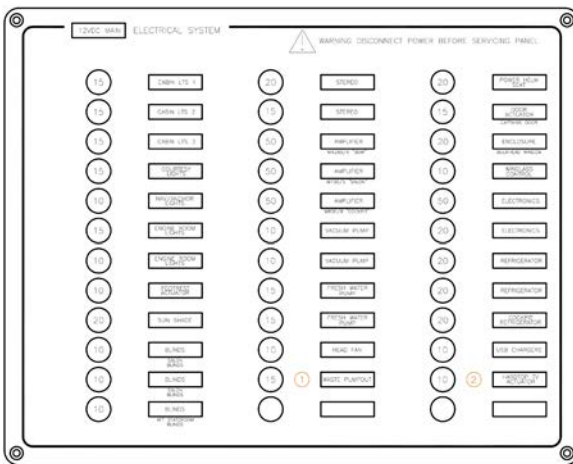

DC distribution panel

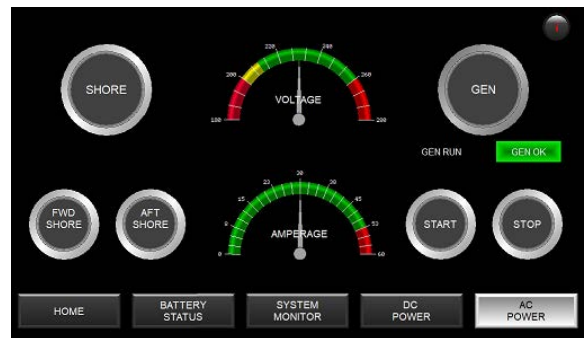

AC Power screen, power-up panel

The AC electrical system operates on a 240V 50A system. The AC system is fed by shore power or by the generator. The boat is equipped with an ELCI (equipment leakage current interrupter) that uncouples the boat's power system from shore power if a problem is detected. Use the ELCI power reset button in the starboard aft shorepower cabinet to restore power if the shorepower circuit breaker has been tripped. The ELCI eliminates the need for a galvanic isolation system and reverse polarity indicator. Refer to the ELCI manual for additional information.

### Power Source Selection

The AC Power screen of the power-up panel, installed on the port helm console, allows selection of shore power or generator power. The use of this controller prevents the shore power source and the generator source from being energized simultaneously and damaging electrical system components. Refer to further information about shore and generator power later in this section.

The shore power (SHORE) and generator (GEN) buttons on the AC Power screen of the power-up panel activate breakers that protect the AC distribution system. These breakers are very sensitive. The resulting power surge that occurs when connecting the dockside cord or starting the generator may cause the main breaker to trip. To avoid this surge, always ensure the buttons are OFF before plugging or unplugging the shore power cord or starting or stopping the generator.

In the event of a power-up panel failure, the AC source (SHORE or GEN) may be selected manually. To manually switch the boat from shore power to generator power, access the contactor box located outboard of the starboard engine in the engine room. A key is attached to the side of the box with a plastic tie. The generator must be running to switch from shore power to generator with the backup key. Insert the key into the key switch on the side of the box. The key switch will manually switch the contactors from shorepower to generator.



*Contactor box*

### GFCI Protection of AC Outlets

All AC outlets installed in your boat are protected by ground fault circuit interrupters, or GFCIs. A GFCI senses any imbalance in the current flowing through the circuit and will interrupt power in order to prevent electrocution. If an outlet isn't working and the appropriate breaker on the AC distribution panel is switched on, check the GFCI panel installed in the engine room and reset if necessary.

If the problem persists, contact your Tiara Yachts dealer or a qualified marine electrician.

### AC Main Breakers

There are a number of breakers on the Master AC box panel, located in the engine room, that need to be switched ON for their corresponding components to operate.

**Chiller breaker:** Supplies power to the air conditioning chiller refrigeration unit. This breaker must be ON in order to use the air conditioning unit(s).

**Air Cond Pump breakers:** Supply power to the chiller raw water and circulation pumps. This breaker must be ON in order to use the air conditioning unit(s).

**Air Cond 1, 2, 3, and 4 breakers:** Supply power to the air handler/blowers. The AIR COND PUMP breakers must be turned ON to operate the air conditioning. See section 6, Ventilation Systems, for climate control panel locations. Refer to the air conditioner owner's manual for additional information.

**Water Heater breaker:** Supplies electrical current to the water heater. The water temperature is automatically controlled by the temperature valve on the water heater. Do NOT turn this breaker ON without having water in the water heater. See section 5, Plumbing Systems, and the water heater owner's manual for more information.

**Cabin:** Supplies power to the AC distribution panel.

**Gyro Stabilizer breaker (optional):** Supplies power to the Seakeeper Gyro stabilizer, if installed.

**Cockpit Cooler breaker (optional):** Supplies power to the port alfresco cockpit seat-base cooler's refrigeration unit, if installed.

**Water Maker breaker:** This breaker is available for aftermarket installation of a water-maker.

**Inverter breaker:** Allows AC current to pass through the inverter when the inverter is not operating. This breaker must be ON for outlets to work.

**Battery Charger/Inverter breaker:** Supplies power to the house battery charger/inverter. The charger/inverter charges the house battery bank when connected to shore or generator power, and uses the house battery bank to supply AC power when shore and generator power are not available.

**Battery Charger breaker:** Supplies power to the battery charger that charges the two engine battery banks.

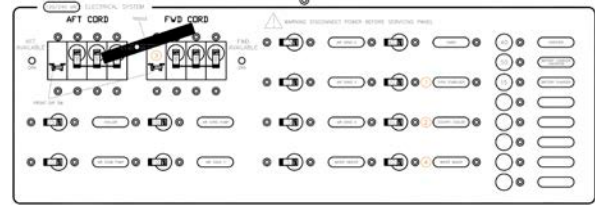

Master AC panel (typical)

## AC Voltmeter

Monitor the available AC voltage periodically, in order to detect abnormal operating conditions early. To check the voltage, consult the voltmeter on the AC Power screen of the power-up panel. The voltmeter will indicate the current voltage of the power source (shore power or generator) and the load currently being applied to that source. If the voltage being supplied while using the 240V-50A connection is lower than 228V or higher than 252V, discontinue use and correct the problem as soon as possible.

## AC Distribution Panel

The AC distribution panel is located in the third stateroom electrical cabinet.

There are a number of breakers on the AC distribution panel which need to be switched ON for their corresponding components to operate:

**Outlets 1, 2, 3 and 4 breakers:** Supply electrical current to the boat's electrical outlets and protect against short circuits and overloads.

**Microwave breaker:** Supplies electrical current directly to the microwave/convection oven. See the oven owner's manual for more information.

**Deck Grill breaker:** Supplies electrical current to the aft galley grill. This breaker should be on ONLY when the grill is being used. See the grill owner's manual for more information.

**Refrigerator breakers:** Supply AC electrical current to the galley refrigerator/freezers.

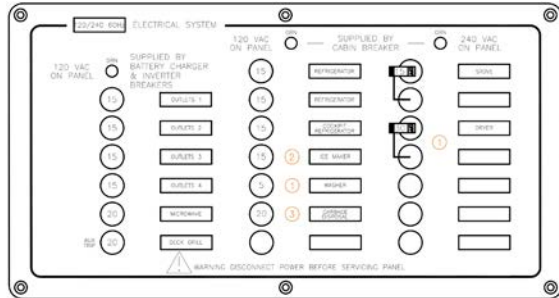

AC distribution panel (typical)

**Cockpit Refrigerator breaker:** Supplies AC electrical current to the aft cockpit refrigerator.

**Ice Maker breaker (optional):** Supplies electrical current to the cockpit ice maker, if installed.

**Washer breaker (optional):** Supplies power to the master stateroom washing machine, if installed.

**Garbage Disposal breaker (optional):** Supplies power to the galley garbage disposal, if installed.

**Stove breaker:** Supplies power to the galley stove.

**Dryer breaker (optional):** Supplies power to the master stateroom dryer, if installed.

#### 4.8 Shore Power

Use 240V-50A shore power whenever available to allow full functionality of your boat's AC system. A 240V-50A shore power cable is located in the aft cockpit starboard shore power locker, and is connected to a powered cable recoil system. To pay out or retrieve the cord, the CABLEMASTER breaker on the DC distribution panel must be ON.

The shorepower system is designed to be connected to one 240V/50A dockside outlet. Before every use, check the shorepower cord(s) for cracks and chafing of the insulation, and check cord terminals for corrosion or heat damage.

Shorepower connections are installed in the lower aft transom starboard step and in the forward anchor locker.

Your boat is equipped with an equipment leakage current interrupter (ELCI), installed next to the shorepower inlet circuit breaker.

Even in a properly grounded boat, some current can leak into the water via the connection between the AC grounding system and the boat's bonding system. Electrical current leaking into the water can be very dangerous to anyone swimming around the boat. Leakage will also cause accelerated corrosion of submerged metal.

The ELCI makes sure that all the electricity sent from a shorepower pedestal returns to it. The ELCI detects any current leaking into the water by monitoring any imbalance in the amount of current traveling on the hot and neutral wires. If less current comes back on the neutral (white) wire than in on the hot (black) wire, a leak exists. The ELCI detects the danger and trips the circuit protection (shorepower circuit breaker) device.



**DANGER**

#### ELECTROCUTION HAZARD

Exposure to high voltage will cause death or serious injury. **DO NOT attempt to correct wiring yourself. DO NOT swim in marinas or near boats connected to shore power. Keep children away from any electrical cables or equipment and use grounded appliances onboard only.**

**! WARNING**

Do not make connections in wet weather, with wet hands, or with wet cables and connections. Always use a 3-wire electrical system connected to a ground. Do not use worn or damaged cables. Failure to heed this warning can result in an electrical shock injury or death.

**! CAUTION**

When routing electric cables and dockside water hoses to the dock, be sure to allow sufficient slack so the cables and hoses will not be strained in any way as the boat moves within its slip. Do not allow cables or hoses to dangle into the water.

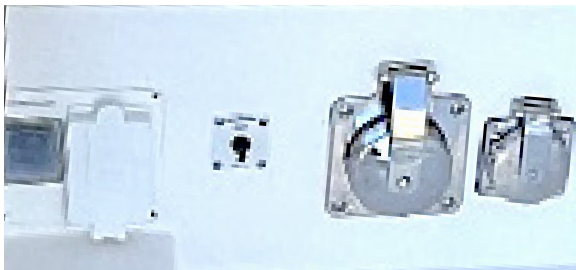

*Aft starboard shorepower locker*

**To connect to shore power:**

1. Unscrew the shorepower cord cover.
2. Move the recoiler switch to the OUT position.
3. Dispense the necessary length of cord to reach the shorepower post on the dock.
4. Move the recoiler switch to the middle (OFF) position.
5. Connect the cord to the power outlet on the dock.
6. Turn the breaker at dock outlet ON.
7. The SHORE button on the power-up panel (installed on the port helm con-

sole) will illuminate BLUE, the gauge will indicate the voltage available, and the AC panel will automatically power up.

**To disconnect from shore power:**

1. Turn off breaker at the shorepower outlet.
2. Disconnect the shore cord.
3. Move the recoiler switch to the IN position.
4. Guide the cord into the hawse pipe to prevent tangling of cord.
5. When the cord fully retracts into the hawse, the motor will stop automatically.
6. Move the recoiler switch to middle (OFF) position.
7. Replace the cover on hawse.

**4.9 Generator**

The diesel generator is located in an enclosure in the engine room. Fuel-injected generators require bleeding of air from the fuel delivery system prior to initial start-up. Bleeding of the fuel system will also be required if the generator is allowed to run out of fuel. Continued attempts to start the generator without bleeding the fuel system under these circumstances can lead to engine damage or erratic operation. This procedure must be completed by your servicing dealer.

The generator is equipped with an automated start-up sequence to prevent over-cranking (which can lead to engine damage) and to ensure that the generator is up to operating temperature before the electrical load is applied. The display on the generator control panel, installed near the Master DC Panel on the forward engine room bulkhead, provides detailed information on the operating status of the generator, including warnings, alarms, and error messages. Refer to the generator owner’s manual for instructions on operation and interpretation of the displayed data.

It is important to activate the house battery charger to maintain the house batteries whenever the generator is running. Because

of the number of DC systems on this boat, a significant drain on the batteries can occur. Depending on the RPM and the duration of operation of the engines, the engines' charging systems may not be able to keep up with the DC electrical demand, particularly when the engines are run at low RPM for extended periods. To ensure that the batteries remain at peak charge, Tiara strongly recommends that the generator be run whenever the boat is in use (and not connected to shore power).



*Remote generator display*



### WARNING

Do not start the generator until you are sure there are no fuel fumes in the bilge or mechanical space. Fuel vapors are explosive and may ignite during generator start-up, causing serious injury or death.



### CAUTION

If the generator fails to start after 60 seconds of cranking, cease operation. Before attempting to crank again, drain the water from the generator's muffler. Failure to do so could result in raw water contamination of the generator's cylinders and damage the engine.



### CAUTION

Before starting the generator, ensure the fuel supply and return valves are open. A fuel valve is open when it is parallel to its associated fitting. Failure to open all fuel valves will damage the generator.



### CAUTION

To reduce the risk of fire, investigate all fuel odors immediately and do not start the engines, generator, or other electrical equipment if fuel odors are present.



### CAUTION

DO NOT start the generator with the power-up panel GEN button illuminated. Allow the generator to warm-up three to four minutes before transferring the electrical load. After warm-up, press the GEN START button to start the generator.



### NOTICE

DO NOT allow the generator to run out of fuel. Fuel injected generators require air to be removed from the fuel delivery system before initial start-up or if the generator is allowed to run out of fuel. Continued attempts to start the generator with air in the fuel system can lead to engine damage or erratic operation. Air must be purged by your servicing dealer only.

To start the generator:

1. Open all hatches to the bilge area. Investigate and remedy any fuel vapors that are detected.

2. Check the generator oil and coolant levels.
3. Open the generator raw water seacock.
4. Open the diesel fuel supply valve. The fuel valve is located on the fuel tank in the port forward engine room.
5. If the batteries are not already on, engage the ALL BATTERY ON button on the DC Power screen of the power-up panel. Make sure the GEN button on the AC Power screen of the power-up panel (located on the port helm console) is off. The button is ON if it is illuminated in blue.
6. Use the ENG ROOM FAN button on the System Monitor screen of the power-up panel to start the engine room blower.
7. Press the GEN START button once and verify the generator cranks and starts. (The generator can also be started using the generator display installed in the engine room on the master DC panel)
8. Verify the green GEN RUN indicator is illuminated. **NOTE:** the generator must be running and the GEN RUN indicator on in order to switch to GEN power.
9. Press the GEN button. The GEN button will light up blue and the SHORE button will turn gray, indicating that the boat's AC system is now being powered by the generator.

### To stop the generator:

Press the GEN STOP button on the power-up panel's AC Power screen and verify the generator has stopped. The generator can also be stopped using the generator display installed in the third stateroom electrical cabinet.

## Electrical System Maintenance

### DC Electrical System Maintenance

At least semi-annually, spray all exposed electrical components behind the helm and in the plugs with a protector specific for electrical connections.

Make sure to check that all below-deck wiring is properly supported, the insulation is sound, and there are no loose or corroded terminals. Clean any corroded terminals thoroughly with sandpaper, or replace them. Tighten securely and spray with a metal and electrical protector. Inspect all engine wiring.



*AC Power screen of the power-up panel, indicating that the generator is running.*

DANGER

FIRE OR EXPLOSION HAZARD

Explosion or fire from hydrogen gases produced by lead acid batteries will cause death or serious injury. **DO NOT** smoke or bring a flame near the battery storage area. If ignited by a spark or flame, gas may explode violently, causing spraying of battery acid or fragmentation of the battery.

Check the electrolyte level in the batteries regularly and add distilled water as necessary. If the batteries are frequently charged by a battery charger, check the electrolyte level more often. The correct fluid level in the cells is approximately 1/4 to 1/2 inch above the plates. If fluid is needed, fill to the proper level with distilled water **ONLY**. **DO NOT** over-fill. Some batteries are sealed and cannot be filled.

Keep the tops of any battery clean and dry. Dirt and water can conduct electricity from one post to the other and can cause battery discharge or engine warnings.

Keep the battery posts free of corrosion. DO NOT use wing nuts to attach battery cables. Remove the cables and clean the posts and cable clamps with a battery post cleaner or sandpaper as required. Coating the battery posts and cable clamps with petroleum jelly or silicone grease will help protect them and reduce corrosion. Battery cables, both positive and ground, must be replaced when they show signs of corrosion or fraying. Deteriorated cables cause a considerable voltage loss when high currents are drawn, such as when starting the engine. See the battery owner's manual for maintenance information.

### AC Electrical System Maintenance

Inspect all wiring insulation for nicks, chafing, brittleness, improper support, etc., periodically. Inspect portable appliance cords and plugs.

DANGER

**ELECTROCUTION, FIRE OR EXPLOSION HAZARD**

**Contact with live wires or working on an energized electrical system will cause electrocution. It can also cause sparks, resulting in fire and/or explosion. Both cases will result in death or serious injury. DO NOT work on an energized system or allow unqualified personnel to work on the system.**

Examine the shorepower cord for cracks in the insulation and corrosion in electrical connectors. Spray receptacles and electrical connections with an electrical contact cleaner or a metal and electrical protector to help reduce corrosion and improve electrical continuity.

### Generator Maintenance

The engine maintenance required on the generator is similar to that required for the main engines. The most important factors affecting

the generator's longevity are proper ventilation and the maintenance of the AC alternator and the fuel, ignition, cooling and lubrication systems. Maintenance schedules and procedures are outlined in your generator owner's manual; follow them exactly.

### General Precautions

- Whenever possible, have electrical work done by a qualified electrician or your Tiara Yachts dealer.
- DO NOT work on an energized system; make sure all power sources are off.
- DO NOT allow unqualified personnel to perform electrical maintenance; only a qualified marine electrician should work on the electrical system.
- DO NOT work in a wet area.
- Use caution when connecting wires, in order to avoid reversing polarity.
- DO NOT alter wires or connectors, or use inferior parts. Use OEM replacement parts only.

Corrosion on the electrical connectors can cause poor connections, shorts and ground faults, and/or poor ground connections. Check at least annually and clean as required. DO NOT allow corrosion to build on connections.

Inspect all terminals and make sure they are tight.

Have the entire AC circuitry and the shorepower cord tested every season by an experienced marine electrician. This will detect any shorts, open wires, or ground faults. Also, have the polarity indicator system inspected for proper operation.

Test all outlets periodically by pressing the test/reset buttons in the center of the face plate to ensure proper operation.



Plumbing Systems

5.1 Freshwater System

The freshwater system consists of one potable water tank, distribution lines, and a distribution pump. The pump is equipped with an automatic pressure switch.

The tank is filled through the labeled deck fill on the port gunwale. Use the provided winch handle to remove and replace the desk fill.



Fresh water pump (typical)

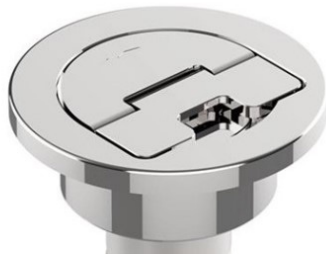

Water tank(s) deck fill

Operation

DO NOT confuse other deck fills with the freshwater fill. If toxic fluids or fuel is added to a freshwater tank, the system will be contaminated. DO NOT attempt to pump fuel out; this system is not designed to pump fuel. Fuel must be removed by qualified personnel only. Fuel in the freshwater systems will also require replacement of that system and/or many components.

**! DANGER**

**FIRE OR EXPLOSION HAZARD**  
 Fuel and their vapors are highly explosive when exposed to open flame or spark, resulting in death or serious injury. Do not confuse deck fills.

**! WARNING**

**HEALTH HAZARD**  
 Disinfect the entire fresh (potable) water system prior to first use, and annually at the beginning of each season. Failure to do so can result in developing coliform bacteria or other disease-causing organisms (pathogens) in the water system. Consumption of contaminated water could result in severe personal injury or death.

Follow the instructions in section 5.2, Freshwater System Commissioning, to disinfect the system at the beginning of each season. Once the system is commissioned, to refill the water supply tank(s), use a dockside hose and fill the tank(s) slowly through the freshwater fill. The tank should be filled until water runs out of the vent located on the hull side just below the fill. After filling the tank(s), partially open all faucets. Switch ON the FRESH WATER PUMP breaker on the DC distribution panel, located in the third stateroom electrical cabinet. Allow the pump to run until all of the air is purged from the system and a steady stream of water is flowing from each outlet. Next, turn off the faucets one by one. As the pressure builds, the pump will automatically shut off.

When properly primed and activated, the water system will operate like the water system in a home. An automatic pressure sensor keeps the system pressurized. If the system has been recently filled or has not been used

for an extended period, air may accumulate at the pump and the system may have to be re-primed.

Whenever the boat is left unattended, turn the FRESH WATER PUMP breaker OFF.

 <b>CAUTION</b>
<p><b>DO NOT allow the fresh water pump to run dry; damage to the pump can occur. The fresh water pump works on demand and WILL NOT shut off when the tank is empty. Turn the water pump switch OFF when the system is not in use. Operating any pump from a low-charged battery can lead to a pump failure. Keep the batteries properly charged. The fresh water system must be properly winterized prior to winter lay-up. Refer to winterizing directions in section 12, Seasonal Maintenance.</b></p>

### Sink and Shower Operation

To use the sinks or showers, switch ON the FRESH WATER PUMP breaker on the DC distribution panel. Some minor variations in the water temperature and pressure may occur as the pump cycles.

The sinks drain overboard. Shower water drains to a sump pump system located in the bilge below the cabin sole. An automatic float switch in the shower sump controls the pump. After showering, let the cold water flow for a period of time to flush the drainage system of soap residue. The shower drain strainers should be cleaned regularly and the sump inspected periodically for accumulated debris that needs to be removed.

### Water Heater

The water heater is located outboard in the port engine room. The water heater uses an AC element that is thermostatically controlled at the heater. A high pressure relief valve protects the system from excessive pressure.

To use the water heater, the WATER HEATER breaker on the Master AC Panel (installed in the engine room) must be ON. Make sure all air is purged from the water heater and lines before activating the water heater breaker. Refer to the water heater manual for additional information.

 <b>CAUTION</b>
<p><b>DO NOT turn on the water heater until it is filled and primed; damage to the heater will result.</b></p>

 <b>CAUTION</b>
<p><b>DO NOT change or modify the shore water inlet connector without contacting Tiara Yachts Customer Relations or your dealer. Modification to or use of the wrong type of connector can damage the fresh water system.</b></p>

### 5.2 Freshwater System Commissioning

The freshwater system must be disinfected before first use, and annually at the beginning of each season. A clean, sanitized freshwater system will greatly reduce the risk of developing coliform bacteria or other disease-causing organisms (pathogens), and will help protect the health of everyone onboard.

The freshwater tank is located below the mid-cabin sole.

#### To drain the system of antifreeze (if used):

1. Open all sink and shower faucets (hot & cold). Set single faucets to the warm position.
2. Switch ON the FRESH WATER PUMP breaker(s), located on the DC distribution panel (installed in the third stateroom electrical cabinet). The pump is self-priming.

3. When anti-freeze stops flowing out of the faucets, switch the FRESH WATER PUMP breaker OFF. Do not close faucets.
4. Fill the freshwater tank(s) with clean, fresh water. The fill fitting for the water tank(s) is on the port gunwale, labeled WATER. The tank(s) should be filled until water runs out of the vent located on the hull side just below the fill.
5. Keeping all faucets open, switch ON the FRESH WATER PUMP breaker and empty the water tank(s). When the water tank(s) is empty turn the pump breaker(s) OFF.
6. Repeat steps 5 and 6 until all nontoxic potable water antifreeze is removed from the system.

nontoxic antifreeze before storage, drain it following the instructions provided previously.

2. Close all faucets.
3. Prepare a chlorine sanitizing solution: in a container with 1 gallon of fresh water, mix 1/4 cup of Clorox® or Purex® regular unscented household bleach (5% sodium hypochlorite solution) for each 15 gallons of water tank(s) capacity.

<i>Tank capacity vs. cups of bleach</i>	
<b>Water Tank Capacity</b>	<b>Cups of Bleach</b>
15 Gal	1/4 Cup
30 Gal	1/2 Cup
45 Gal	3/4 Cup
60 Gal	1 Cup
75 Gal	1-1/4 Cups
90 Gal	1-1/2 Cups
105 Gal	1-3/4 Cups
120 Gal	2 Cups
135 Gal	2-1/4 Cups
150 Gal	2-1/2 Cups

**WARNING**

**HEALTH HAZARD**

**Disinfect the entire fresh (potable) water system prior to first use and annually at the beginning of each season. Failure to do so can result in developing coliform bacteria or other disease-causing organisms (pathogens) in the water system. Consumption of contaminated water could result in severe personal injury or death.**

**CAUTION**

**Notify all persons aboard that the fresh water system is being sanitized. Do not allow anyone to drink from the fresh water system during the sanitizing process.**

**To disinfect and commission the fresh-water system:**

1. Ensure the water system, including the water heater and pump, is drained completely. If the system was filled with

4. Fill the freshwater tank(s) halfway with clean, fresh water.
5. Pour the sanitizing solution into the water tank(s) through the deck WATER fill fitting.
6. Fill the freshwater tank(s) with clean, fresh water. The fill fitting for the water tank(s) is on the port gunwale, labeled WATER. The tank(s) should be filled until water runs out of the vent located on the hull side just below the fill.
7. Switch ON the FRESH WATER PUMP breaker(s) on the DC distribution panel, located in the third stateroom electrical cabinet.
8. At each faucet, run about 1/2 gallon of water out of each tap (hot and cold), then close the tap. You should be able to smell chlorine out of each tap.

9. Switch OFF the FRESH WATER PUMP breaker(s).
10. **Allow the chlorine sanitizing solution to sit in the system for three (3) hours.** A shorter time period will require a greater concentration of chlorine sanitizing solution to disinfect the water system.
11. Switch ON the FRESH WATER PUMP breaker(s).
12. Drain the chlorine sanitizing solution: open all faucets (hot & cold), set single faucets to the warm position, and empty the water tank(s). Ensure the water system, including the water heater and pump, is drained completely. When the water tank(s) is empty turn the pump breaker(s) OFF.
13. Fill the freshwater tank(s) with clean, fresh water (see step 6). The tank(s) should be filled until water runs out of the vent.
14. Keeping all faucets open, switch ON the FRESH WATER pump breaker(s) and empty the water tank(s). When the water tank(s) is empty turn the pump breaker(s) OFF.
15. Fill the tank(s) again, until water runs out of the vent. Switch ON the FRESH WATER pump breaker and empty the tank(s). Switch the breaker back OFF.
16. Final fill: Fill the freshwater tank(s) with clean, fresh water. The tank(s) should be filled until water runs out of the vent on the hull side just below the WATER fill.
17. Switch ON the FRESH WATER PUMP breaker(s) and open all faucets. When a smooth flow of water is observed from each hot and cold tap, close the faucet. When all faucets are closed, the pump(s) will shut off as the system pressure increases. Any air should now be purged from the system.

The freshwater system is now commissioned and ready for use.

**To remove excessive chlorine taste or odor that might remain in the system, do the following:**

1. Ensure the water tank(s) has enough available capacity to accept 10 additional gallons. If there is ample room in the tank(s), proceed to step 3, below. If not, continue to step 2.
2. Drain at least 10 gallons of water from the system to make room for the vinegar solution (step 3). To do this, switch ON the FRESH WATER PUMP breaker(s) on the DC distribution panel, located in the third stateroom electrical cabinet, and open a faucet. When at least 10 gallons have been drained, close the faucet and turn the pump breaker OFF.
3. Prepare a solution of one (1) quart vinegar to five (5) gallons fresh water.
4. Pour the vinegar solution into the water tank(s) through the deck WATER fill fitting on the port gunwale.
5. Allow the vinegar solution to agitate in the tank(s) for 24 hours.
6. Switch ON the freshwater pump breaker and drain the vinegar solution by opening all faucets (hot & cold), setting single faucets to the warm position, and emptying the water tank(s). When the water tank(s) is empty turn the pump breaker(s) OFF.
7. Close all faucets.
8. Fill the freshwater tank(s) with clean, fresh water. The fill fitting for the water tank(s) is located in the water connection locker under the port gunwale. The tank(s) should be filled until water runs out of the vent located on the hull side just below the fill.
9. Switch ON the freshwater pump breaker(s) and open each faucet. When water flows smoothly from the hot and cold tap, close the faucet. When all faucets are closed, the pump will shut off as the system pressure increases. Any air should now be purged from the system
10. Repeat if necessary.

## 5.3 Marine Head System

Your boat is equipped with a VacuFlush® marine head system. This system uses a small amount of water and a vacuum, which is powered by a 12-volt vacuum pump, to flush. The toilet is connected to the pressurized freshwater system. Fresh water is used to reduce odor in the head compartment.

Before using the toilet, switch ON the VACUUM PUMP and FRESH WATER PUMP breakers on the DC distribution panel (installed in the third stateroom electrical cabinet). To use the toilet, lift the foot flush lever slightly to wet the bowl with the desired water level. Depress the flush lever all the way for approximately three seconds or until the bowl is clear. A sharp popping noise is normal when the vacuum seal is broken and flushing action begins. It is also normal for a small amount of water to remain in the bowl after flushing.

### NOTICE

**DO NOT operate the macerator dry; damage to the pump can occur. In some waters it is illegal to discharge waste overboard. Remove the sea-cock handle or use another method to prevent accidental discharge.**

The waste is directed to the holding tank until it is pumped out by a waste dumping station or the overboard macerator discharge system. The waste moves through a small opening in the toilet base. Incoming air mixes with and fragments the waste as it passes through the base opening. This process eliminates the need for a macerator or mechanical motors in the toilet base.

The vacuum generator, located on top of the waste tank below the cabin atrium sole, contains a stored vacuum and is connected to the holding tank. The system vacuum is monitored by a vacuum switch, which is located

on the vacuum generator tank. When the switch senses a drop in vacuum pressure in the system, it automatically signals the pump to energize and bring the vacuum back to operating level. This process is normally completed in less than a couple minutes.

It is normal for the stored vacuum to leak down slightly between flushes, causing the vacuum pump to run for a short period. After the last flush, the pump should not run more than once every three hours to recharge the system. Refer to the head owner's manual for more information on the operation of the system.

### Holding Tank

The holding tank is installed under the cabin sole and is accessible via the atrium floor hatch.

Monitor the holding tank level using the holding tank monitor on the System Monitor screen of the power-up panel (located on the port helm console), and have the tank pumped out before it is completely full.

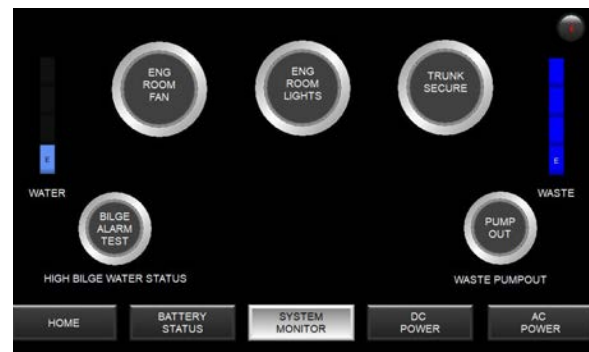

*Waste holding tank monitor (far right)*

**If the tank is allowed to overflow, the waste will overflow out the tank vent and overboard.**

### To empty the waste tank:

1. At a marine facility pump-out station, remove the cap from the WASTE deck plate, located on the starboard gunwale,

- using a winch handle. Turn counter-clockwise until the cap is loose; remove the cap and set it in a safe place.
2. Insert the pump-out station hose into the WASTE deck plate opening.
  3. Turn the pump-out station pump equipment on. Remove all waste from the holding tank (check the tank monitor for progress).
  4. Insert the pump-out station's water hose into the WASTE deck plate opening. Fill the tank with clean water and repeat steps 2 and 3.
  5. Replace the deck plate cap and tighten with the winch handle.



Waste pump-out deck plate

**To pump waste overboard (if your boat is equipped with the optional overboard discharge seacock):**

1. Ensure your vessel is in a legal raw sewage discharge area.
2. The overboard waste discharge seacock may be accessed by lifting the master stateroom hallway sole hatch. **Note: The overboard discharge seacock is wired to the closed position at the factory.**
3. Remove the cable tie securing the overboard discharge seacock.
4. Open the discharge seacock by pulling the handle to the vertical position.
5. Press the PUMP OUT button on the System Monitor screen of the power-up panel (located on the port helm console). Allow the discharge pump to run until the waste tank is empty. The sound

of the pump's motor load and speed will change when the tank becomes empty.

- Note:** Should the pump not activate, check to see that the seacock is in the OPEN position and that the WASTE deck plate cover is tightened securely. If not, the discharge system will not operate properly.
6. When the tank is empty, press the PUMP OUT button again to turn the pump off.
  7. Close the overboard discharge seacock by pushing the handle to the horizontal position, and secure it. The overboard discharge seacock **MUST** be closed to prevent water from being forced back into the system.



Overboard waste discharge seacock (typical)



## NOTICE

**It is illegal to discharge raw sewage from a vessel within a three mile limit of the territorial waters of the United States of America. It is illegal to discharge raw sewage from a vessel within the navigable waters and rivers of the United States including the Great Lakes. When in international waters it is the responsibility of the vessel owner/operator to follow all local laws and restrictions.**

**NOTICE**

Some local regulations require overboard discharge systems to be physically secured in a closed position during use of the boat in waters designated as “no discharge” areas. Check with local boating regulations. Refer to the system owner’s manual for additional information.

**Holding Tank Maintenance**

The tank vent air filter is installed on top of the holding tank and may be accessed by lifting the cabin atrium floor hatch. Replace the holding tank vent air filter annually for the most effective odor control.



*Tank vent filter (typical)*

Clean and inspect the head for leaks regularly. Periodically add chemicals to the head to help control odor and to chemically break down the waste. Refer to the head owner’s manual for additional operating and maintenance information.

**NOTICE**

The head and macerator systems must be winterized before winter lay-up; refer to section 12, Seasonal Maintenance.

**5.4 Washdowns**

The fresh water washdown uses water from the freshwater tank. The raw water washdown system pump is supplied by hoses connected to a ball valve and a thru-hull fit-

ting located in the aft mechanical space. The raw water washdown draws sea water from a thru-hull installed in the hull bottom.

**CAUTION**

When routing electric cables and dockside water hoses from the boat to the dock, be sure to allow sufficient slack so cables and hoses will not be strained in any way as the boat moves within its slip. Do not allow cables or hoses to dangle into the water.

**Raw Water Washdowns**

To use a raw water washdown, connect a hose to the labeled connection in the anchor locker or water connection cabinet (located under the port aft cockpit step). Make sure the ball valve is open before attempting to operate the raw water washdown system. Activate the pump by turning ON the WASH-DOWN PUMP breaker on the Master DC distribution panel in the engine room. As pressure builds in the washdown hose, the pump will shut off.

When the washdown hose is in use and the pressure drops, the pump will turn on. Turn the WASHDOWN breaker off when the washdown is not in use. The raw water washdown system is equipped with a sea strainer on the intake side of the pump, located in the engine room; check it frequently and clean as necessary.



*Fresh and raw washdown inlets are installed in the water connection locker under the aft transom port step and in the upper anchor locker*



Typical raw water strainer (left) and pump

### Priming the System

Open the ball valve and switch ON the WASHDOWN breaker on the Master DC Panel (installed in the engine room). Run the pump until all air is purged from the system. Close the thru-hull ball valve before the boat is hauled from the water to eliminate any air lock in the system. It may be necessary to re-prime the raw water system if the system is not used for an extended period.



### CAUTION

**DO NOT** operate the high-pressure pump when dry, or damage to the pump will result. Turn the WASH-DOWN PUMP breaker OFF when leaving the boat unattended.

### 5.5 Drainage

Some of the drain thru-hull fittings are equipped with ball valves that are always open under normal operating conditions. Check and operate the drain valves at least once a month to make sure they are in good condition and operating properly. Also, check the drain system to ensure it is free flowing and that the hoses on the thru-hull fittings are secure and not leaking.

Review and become familiar with the location of your boat's thru-hull drain valves.

In the event of an emergency, close the valves to prevent sea water from entering the boat through the drainage system. **NOTE:** Having one or more drain valves closed can be dangerous to the boat and all onboard. If this occurs, distribute PFDs and take all necessary safety precautions, including notifying the Coast Guard or local agency, until the source of the problem is determined and corrected.

### Bilge Drainage

The aft bilge pump is located in the aft mechanical space, the mid pump is located in the forward engine room, and the forward pump is located under the cabin atrium sole.

The remote pump for the forward bilge pump may be accessed via the master stateroom hallway floor hatch. The forward bilge pump pick-up is remotely mounted under the removable floor panel in the master stateroom hanging locker.

All bilge pumps pump water out of thru-hulls located above the waterline in the hull. The high water bilge alarm monitors excessive bilge water levels and signals a high water condition through a visual and audible alarm.



Bilge pump (typical)



Under this condition, the bilge pumps will be automatically activated and the boat horn will sound until the bilge water falls to a safe level. Check the high water alarm display on the System Monitor screen of the power-up panel, installed on the port helm console. See section 4, Electrical Systems, for additional information on bilge pump and high water bilge alarm operations.

Excess water in the bilge area will adversely affect the handling and maneuverability of the boat and can cause personal injury. Use the BILGE buttons at the helm to manually activate the bilge pumps briefly each time the boat is used to ensure pumps are operating properly. There is a delay built into the bilge pump's float switch before the pump will activate. Refer to the bilge pump and float switch owner's manuals for details.

Power is supplied to the automatic float switches on each bilge pump whenever the batteries are connected. Debris can prevent the pumps from operating or make it operate continuously. Make sure no debris is blocking the bilge pump float switches.

Inspect the bilge areas frequently for evidence of excessive water. Continuous operation of a bilge pump can indicate that there is excess water in the bilge or a leak, or that a drain plug is installed incorrectly. Test the bilge pumps at regular intervals. Bilge pumps and bilge pumping systems are not designed for damage control.

DO NOT allow the bilge pump to operate after all the water has been cleared from the bilge area, or damage to the pump will occur. When water has been cleared, turn OFF the BILGE buttons at the forward helm.

Any oil spilled in the bilge must be thoroughly removed and properly disposed of before operating the bilge pump. The discharge of oil from the bilge is illegal and subject to fine.

When the boat is out of the water, the bilge can be drained by unplugging the thru-hull

drain located in the hull bottom near the transom. It is important to check the drain plug regularly to make sure it is tight. A loose drain plug will allow sea water to enter the bilge and cause the boat to sink. Check the drain plug frequently to make sure it is secure.

NOTICE

**The US Federal Water Pollution Control Act prohibits the discharge of oil or oily waste into or upon the navigable waters of the United States or the waters of the contiguous zone if such discharge causes a film or sheen upon, or a discoloration of the surface of the water, or causes a sludge or emulsion beneath the surface of the water. Violators are subject to a penalty of \$10,000.**

### Exterior Drains

The cockpit sink drains by gravity to overboard thru-hulls.

The anchor locker drains overboard through a drain fitting located in the hull side at the bottom of the anchor locker. Floor boxes in the alfresco and aft cockpit also contain drain fittings. It is important to inspect all drains frequently to remove any accumulated debris.

## 5.6 Plumbing System Maintenance

Refer to your water system components owner's manuals for additional operation and maintenance information.

### Freshwater System

Perform these routine maintenance procedures to maintain your freshwater system:

- Remove filter screens from faucet spouts and eliminate any accumulated debris. A debris build-up can cause the water pump to cycle excessively.

- Check and clean the freshwater system strainer (located on the intake line near the pump) at least annually.
- Test each bilge pump's float switch by holding two fingers over the raised circular areas of the switch for approximately 10 seconds to activate the pump.
- Remove the lid on the shower sump assembly periodically. The shower sump is installed under the master stateroom hallway sole. Clean debris from the sump and flush with clean water. Activate the float switch to test the pump. Spray the pumps and metal components with a metal protector periodically.
- Add a commercially available potable water conditioner to the water tank(s) to keep it fresh.
- Make sure the FRESH WATER PUMP breaker on the DC distribution panel is switched OFF when leaving the boat unattended or when not in use.

**CAUTION**

Turn the DC distribution panel **FRESH WATER PUMP** breaker(s) OFF when leaving the boat unattended or when the fresh water system is not in use.

The water system must be winterized before storage. Refer to section 12, Seasonal Maintenance.

**Raw Water System**

Perform these routine maintenance procedures to maintain your raw water system:

- Check all hoses, and especially the sea water hoses, for signs of deterioration.
- Remove and clean the air conditioner and washdown pump sea water strainers, as needed. Spray the pumps and thru-hull valves with a metal protector periodically.
- Operate all thru-hull valves at least once a month to keep them operating properly.

If a hose ruptures or leaks, turn off the wash-down pump, using the WASHDOWN PUMP breaker on the Master DC Panel, immediately. Keep the thru-hull valve closed when performing service on a sea water system.

**CAUTION**

If a hose ruptures, turn the **WASH-DOWN PUMP** breaker on the Master DC panel, located in the engine room, OFF. Close the thru-hull valve before performing maintenance on the sea water pump. Operating any pump from a low-charged battery can lead to a pump failure. Keep the batteries properly charged. The raw water system must be properly winterized prior to winter lay-up. Refer to section 12, Seasonal Maintenance.

**CAUTION**

Maintain a proper charge on the batteries; operating the pressure pump from a battery with a low charge could lead to pump failure.

**Raw Water Intake Strainers**

The engine raw water intakes, generator raw water intake, air conditioning raw water intake, and raw water washdown pump intake (if installed) are equipped with strainers. Check the strainers each time you use the boat to ensure that no debris has accumulated that may block the flow of water.

**To clean clogged strainers:**

1. Turn OFF the related engine or pump.
2. Close the raw water seacock, in the hull bottom, to stop the flow of water to the strainer.
3. Remove the filter basket cap by unscrewing it counterclockwise. A spanner wrench has been provided for this purpose.



Water strainer (typical)

4. Lift the filter basket out by the top handle.
5. Remove any debris from the filter basket and rinse with clean water.
6. Use only mild soapy water to clean the sight glass.
7. Check to be sure that the o-ring under the cap is intact and replace if necessary.
8. Apply a waterproof grease that is silicon- or Teflon-based (do not use petroleum-based grease) to the cap threads and o-ring seasonally, to assure easy cap loosening for inspections and cleaning.
9. Install the filter basket.
10. Install the cap, and tighten by hand.
11. Snug the cap with the spanner wrench.
12. Open the seacock.
13. Start the related engine or pump, and check the system for leaks.
14. If the strainer is leaking, immediately close the related seacock and verify the filter cap is installed correctly with a good o-ring.

The raw water system must be winterized before storage. For more information, refer to section 12, Seasonal Maintenance.

## Drainage Systems

Perform these routine maintenance procedures to maintain your drainage system:

- Clean the cockpit drain rails with a hose and water to remove all debris.

- Clean the hardtop leg drain holes, especially before winter storage.
- Clean the bilge pump of any debris.
- Check the bilge for debris that can block the function of the automatic switch.
- Test each automatic bilge pump float switch each time the boat is used, for proper operation. Hold two fingers over the raised circular areas of the switch for approximately 10 seconds to activate the pump. Alternatively, add water to the bilge until the water level is high enough to activate the pump.

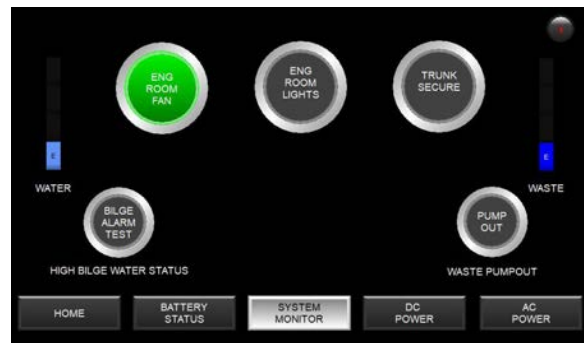

Bilge Alarm Test button on the power-up panel

- Test the high water alarm each time the boat is used. Press the BILGE ALARM TEST button on System Monitor page of the power-up panel, located on the port helm console.
- Flush all gravity drains with fresh water periodically, to keep them clean and free-flowing.
- Clean and inspect the shower and sink drain sump system periodically; the shower sump may be accessed by lifting the master stateroom hallway floor hatch. Remove accumulated debris and flush with fresh water.
- Operate the thru-hull valves once a month and service as required.
- Check the drain system regularly to ensure it is free-flowing and that the hoses on the thru-hull fittings are secure and not leaking.
- Keep the o-ring on the insert end of the washdown hoses lubricated. Apply a mild liquid soap such as a liquid dish

soap or boat wash to the insert on the hose end. For a long-term lubrication solution, apply petroleum jelly such as Vaseline. Apply a light coat to the hose connection and insert it into the wash-down port. Depending on your location and usage, a monthly application may be necessary.



### **CAUTION**

**DO NOT use harsh chemical drain cleaners in drain systems; permanent damage to the hoses, fittings and system can result. Drains and pumps must be properly winterized before winter lay-up.**

## Ventilation Systems

Ventilation is supplied by opening portlights or using the air conditioning system.

### 6.1 Air Conditioning System

Your Tiara is equipped with a chiller system (installed in the aft mechanical space) that chills and circulates a glycol solution to air handlers throughout the boat. Two air handler/blower units are installed above the aft salon headliner; one is installed below the helm; and the fourth is installed outboard of the port aft master stateroom hanging locker.

To operate the unit(s), first turn ON the AIR COND and AIR COND PUMP breakers on the Master AC panel (installed in the engine room). The temperature is controlled using the climate control panels in the master aft hanging locker; the VIP stateroom forward hanging locker; the forward salon galley cabinet; and the helm glovebox.

The air conditioner is self-contained and sea water cooled. The raw water pump, installed in the aft mechanical space, supplies sea water to the unit, which cools the unit and is discharged overboard.

NOTICE

**Air conditioners use surface water to cool. DO NOT operate the air conditioner out of the water or without the raw water supply, or else damage to the system will occur. Confirm a water supply before operating the air conditioning. The lack of a water supply can also trip the circuit breaker.**

Sea water is supplied to the pump from a thru-hull fitting located in the hull near the pump. A sea strainer between the pump and

thru-hull fitting protects the system from contaminants that can damage the pump or the air conditioning system. Periodically clean the sea strainer basket to make sure the sea water pump receives adequate water.

### 6.2 Carbon Monoxide

Read about carbon monoxide, its hazards, and carbon monoxide detectors in section 9, Safety Information.

### 6.3 Bilge Ventilation

Air flow into the bilge is supplied by a vent on the transom and through use of the engine room blower. To activate, use the ENGINE ROOM FAN button on the power-up panel (installed in the port helm console) or the BLOWER button on the helm.

### 6.4 Maintenance

- Periodically lubricate all hinges and latch assemblies with a light oil. Clean and coat gasket materials with silicone to help keep them pliable.
- The opening portlights are made of acrylic plastic. Acrylic can scratch easily. DO NOT use a dry cloth or glass cleaning solutions; use a soft cloth, mild soap and water for routine cleaning. Solvents and products containing ammonia can permanently damage acrylic. Refer to the acrylic plastic information in section 11, Routine Maintenance, for directions for properly maintaining acrylic.
- Carbon monoxide detectors have a limited life span. The End of Life (EOL) date, five (5) years after the manufactured date, can be found on a sticker adhered to the body of the unit. Plan on replacing this unit prior to the EOL date. See the carbon monoxide detector owner's manual for more information.



Exterior Equipment

7.1 Forward Deck

 **CAUTION**

Unsecured open exterior doors and/or hatches can slam closed and cause injury or damage the boat. Most doors and hatches are equipped with fasteners, hatch lifters, snaps and/or straps to secure them open; make sure they are properly secured while they are open.

Rails and Deck Hardware

Rails and deck hardware perform specific functions. Do not use for securing fenders or mooring lines, which must be secured to the cleats. Make sure mooring lines are clear of rails or stanchions, or damage can result.

Cleats are flush-mounted and must be raised prior to use.

DO NOT use cleats or any other hardware for the purpose of towing or being towed. Inspect all hardware periodically for loosening, wear or damage. Repair or replace immediately.

 **WARNING**

The cleats on your boat have not been designed for, and are not intended to be used for, towing. Using them for this purpose could result in personal injury or damage to your boat. Refer to *Chapman Piloting & Seamanship* for proper towing procedures.

Anchor/Rope Locker

The anchor locker at the bow of the boat can be accessed through the forward deck hatch. An anchor chute and roller assembly is integrated into the bow stem. The chute and

roller assembly is designed for a Delta plow type anchor. A chain snubber is provided to secure the anchor during storage. Use the snubber to ensure the anchor chain is secure before getting underway. The anchor locker is drained by a thru-hull fitting in the hull side near the bottom of the locker. Check it frequently and keep it clean and free flowing.

The anchor must be securely stowed when not in use.

 **CAUTION**

Secure the anchor when it is stored in its locker and make sure it does not rest against the hull sides. If the anchor is loose, it will bounce and damage the boat. Damage from the anchor bouncing in the locker is not covered by the Tiara Yachts warranty.

Windlass

The windlass is located in the foredeck lower anchor locker. The anchor is stored in the chute through the bow and is raised and lowered by the windlass. The anchor line is stored below the windlass and routed out through the windlass to the chain and anchor. The anchor locker is equipped with a receptacle for the windlass remote control.

 **WARNING**

**MOVING PARTS OR ENTANGLEMENT HAZARD**  
Contact with moving parts can entangle and cut, resulting in loss of body parts, strangulation, and/or severe loss of blood, causing serious injury or death. Stay clear of moving parts.

Become familiar with the safe operation of the windlass before using it. Refer to the windlass owner’s manual for operating instructions. Specifics regarding the proper techniques,

equipment, and conditions for safe anchoring can be found in the book *Chapman Piloting & Seamanship*, or through a boating safety course.

To operate the windlass, switch ON the WINDLASS CONTROL breaker on side of the Master DC Panel box in the engine room.

The anchor is lowered by releasing the anchor from the cleat or chain snubber in the locker, and activating the windlass using the remote switch in the anchor locker or the WINDLASS DEPLOY switch at the helm. After the anchor is set, do not allow the windlass to take the force from the anchor line; secure the rode to the cleat in the anchor locker.

Boats at anchor in high swell conditions will snub on the anchor line. This can cause slippage or apply excessive loads to the windlass.

Windlasses are not designed to hold high loads while a boat is at anchor. When the windlass is not in use and the boat is at anchor, the rope rode must be properly tied off to the cleat inside the anchor locker. If your boat is equipped with the optional all-chain rode, the rode must be secured using the chain stopper that is mounted forward of the windlass.

The anchor is retrieved by releasing the line from the bow cleat and activating the windlass using the remote switch in the anchor locker or the WINDLASS RETRIEVE button at the helm. Once the anchor is retrieved, secure the anchor to the chain snubber or bow cleat to prevent it from being released while underway.



### CAUTION

**DO NOT use the windlass as the only method of securing the anchor in the bow pulpit. Secure the anchor line to a cleat or chain snubber before operating your boat.**



*Windlass and anchor rode cleat (typical)*

DO NOT use the windlass as a winch to move the boat over the anchor. Move the boat under its own power to the anchor and to break the anchor loose.

### Foredeck Lounge

The upper foredeck bow locker houses dock line storage space and optional forward shorepower and cable TV connections, if equipped.

The foredeck lounge features a chaise lounge with integrated drink holders. Port and starboard lockers are provided for storing fenders, optional sunshade poles, and provided five-gallon buckets. The middle aft seat cushion can be flipped over to create a tabletop. USB charging ports are installed on both sides of the chaise lounge and a stereo remote control is installed on the port side.



*Bow storage lockers*



Weather covers are provided to protect the lounge and electronics when the boat is not in use. Snap the covers into place before leaving the boat. Remove and securely stow the covers before operating the boat.

### Forward Mediterranean-Style Sunshade (optional)

An optional forward Mediterranean-style sunshade provides shade over the forward lounge. See the manufacturer's owner's manual for additional information.

#### To set up the sunshade:

- Locate the canvas shade and sunshade poles, stored in the starboard bow storage locker.
- Locate the shade pole receptacles on the forward gunwales and at the bow.
- Remove the receptacle cover plate and slide the pole into the receiver.
- Attach the sunshade canvas to the underside of the forward hardtop overhang.
- Attach the sunshade canvas to the cords attached to the shade poles.
- Cinch the cords to tighten the sunshade.

Stow the sunshade and poles during high winds or inclement weather, when underway above idle speeds, before transporting the boat overland, and before storing the boat.

### Windshield

Your boat is equipped with a custom aluminum-framed, tempered glass windshield.

### Hardtop

#### Hardtop

The hardtop is designed to accommodate radio antennas, navigation lights, optional thermal night vision camera, optional satellite TV, and the horn. Four stereo speakers are housed in the forward hardtop visor. The FLIR camera can be operated using the Garmin displays. See the camera owner's manual for more information.

The hardtop is not designed to support the additional weight of items like an instrument locker or a life raft. Do not mount any antennas or equipment to the brow area. The hardtop frame is not designed to support the weight of accessories in this area and can be damaged.

The hardtop warranty will be voided if the top is modified in any way or heavy accessories like radar antennas, spotlights and other accessories are mounted in the wrong location. If you intend to add equipment or make modifications to the hardtop, contact Tiara Customer Relations to make sure the equipment you would like to add or the intended modification will not void the hardtop warranty. Do not climb on the hardtop.

## WARNING

**The hardtop is not a weather deck. Falling from the hardtop can result in serious personal injury or death. Stay off the hardtop.**

## CAUTION

**Care should be exercised to prevent damage to powder coated surfaces. If the surface is scratched, chipped or worn exposing the aluminum, it should be resealed to prevent corrosion from forming. If corrosion is allowed to form, it could cause the powder coating to bubble and lift away. Contact your dealer for repair service.**

### Powered Sunroof

The hardtop features a sunroof above the helm. Press and hold the SUNROOF OPEN and CLOSE buttons on the helm to operate.

In the event power to the sunroof is lost or the motor malfunctions, pull down the headliner panel on centerline (immediately aft of the

sunroof opening) and use a hex key wrench to manually close the sunroof. See section 8, Interior Equipment, for more information.

### Makefast Sun Shade

The Makefast® sun shade is electrically powered and extends to shade the aft cockpit. Activate the sun shade using the SUNSHADE OPEN and CLOSE buttons on the port alfresco cockpit switch panel. The SUNSHADE breaker on the DC distribution panel (installed in the third stateroom electrical cabinet) must be switched ON.

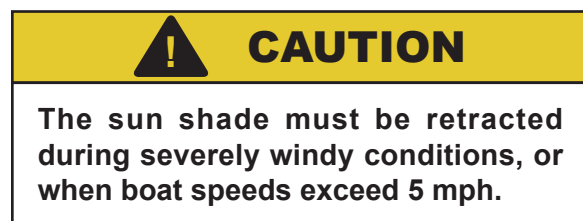

## 7.2 Lighting

Your Tiara is equipped with a Shadow-Caster LED lighting system that can be controlled using the Garmin® OneHelm™ system. The system allows you to set brightness and color for multiple zones and set up and save unique 'lighting scenes.' Control the lights using the Garmin OneHelm display. See on-screen instructions and the lighting system owner's manual for more information.

The Shadow-Caster system allows you to control the following lighting zones:

- LED pin lights installed in the headliner, which can be dimmed or switched from white to red
- courtesy lights
- bow seating
- underwater lights
- exterior multi-color accent rope lighting
- boarding and exit lighting

### Boarding and Exit Lighting

Turning the battery switch off will activate pre-programmed exit lighting: all courtesy lights and some exterior rope lighting will be

illuminated for three minutes to make exiting the boat safer and easier.

The light system remote control may be used to activate the pre-programmed boarding lights, illuminating all courtesy lights and some exterior rope lighting. To override the lighting remote, turn the key fob off and back on.



*Shadow-Caster controls on the Garmin OneHelm*

## 7.3 Alfresco Cockpit

The disappearing bulkhead forward of the alfresco area can be opened to create a seamless flow between interior and exterior. See section 8, Interior Equipment, for operating instructions.

The alfresco cockpit features two aft-facing lounges with insulated cooler boxes underneath the seats. If equipped, the optional port refrigerator box temperature can be set using a control panel installed inside the aft port salon lounge drawer.

The alfresco cockpit also features either a forward-facing lounge with storage or a breakfast bar. If equipped, the breakfast bar can be raised to standing bar height or lowered to seated dining height using the buttons on the switch panel installed outboard of the port aft-facing seat. If equipped, the breakfast bar module also includes ottomans that may be stowed below the bar.

## Alfresco Cockpit Switch Panel and Cabinet

The switch panel installed outboard of the port alfresco cockpit aft-facing seat includes buttons for raising and lowering the breakfast bar (if equipped); deploying and retracting the Makefast sunshade; turning the hardtop lights on and off; raising and lowering the optional cockpit TV; and activating the floor box pumps.

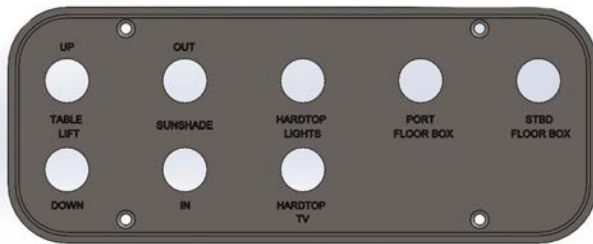

*Schematic of switch panel installed in the port alfresco cockpit*

A stereo control panel and remote joystick are installed in a cabinet aft of the switch panel, outboard of the port alfresco cockpit aft-facing seat.

## Engine Room Access and Light

The center floor hatch in the alfresco cockpit provides access to the engine room.

The switch plate for operating the engine room lights is installed on the lip of the engine room hatch opening. To operate the engine light using the engine light button:

- Press once: light stays on for 15 minutes before shutting off automatically
- Press twice: light stays on for 30 minutes before shutting off automatically
- Press three times: light stays on for one hour before shutting off automatically
- Press four times to turn lights off manually

Two minutes before the engine light turns off automatically, it will start to flash. To override and keep the light on for another 15 minutes, press the button once.

The main battery switches and the Engine Room Light breaker(s) on the DC distribution panel must be ON for the engine room lights to operate.

## 7.4 Aft Cockpit

### Aft-Facing Seat

The aft cockpit includes an aft-facing seat with storage space under the seat cushions and integrated drink holders. A fire extinguisher is stored under the seat.

### Boarding Doors

The hullside port and starboard boarding doors, integrated into the terraces, should be kept secured in the closed position at all times when not in use or when underway. When open, latch the doors in the open position to keep them from swinging and causing injury.



*Hullside boarding doors, shown in the open position*

### Folding Terrace

DANGER

**Read all warnings and operational information prior to attempting deployment of the folding terrace. Failure to do so could result in serious injury or death.**

**DANGER**

The engines should not be started with the folding terrace in the deployed position. Failure to comply could result in serious injury, death or property damage.

**DANGER**

With the exception of the operator, the area near the folding terrace should remain clear of persons and belongings. Failure to comply could result in serious injury, death, or property damage.

**WARNING**

The folding terrace should be deployed **ONLY** in an open water area that is a safe distance from any structure such as a dock or seawall. Failure to comply could result in serious injury, death, or property damage.

**WARNING**

Sea and weather conditions should be considered before attempting to deploy the folding terrace. Failure to comply could result in serious injury, death, or property damage.

Each hullside features a fold-down terrace that expands cockpit space and enhances water access and play. Familiarize yourself with the following instructions before deploying the terraces.

**To deploy the folding terrace:**

1. Secure the integrated hullside boarding door in the closed position.
2. Ensure that no swimmers, boats, or other objects are in the water near the boat.
3. Turn off all engines before deploying the terrace. Do not operate the terrace mechanism while engines are running.
4. Press the TERRACE DOOR button on the helm switch panel to activate the system. The switch will illuminate indicating that the terrace hydraulic system is active. **NOTE:** The engine ignition button at the helm must be OFF before the folding terraces will operate. The terrace DOWN button will not illuminate unless the ignition button is OFF.
5. Press and hold the DOWN button on the terrace switch panel on the outboard gunwale just forward of the terrace. An alarm will begin to sound and will continue to sound as long as the UP or DOWN button is depressed.
6. The terrace will not move immediately, even though the motor will be running. A three-second delay allows the terrace locking pin to retract.
7. Keep the down button depressed until the folding terrace is in the fully deployed position.

Do not operate the engines when the terrace is in the deployed position.

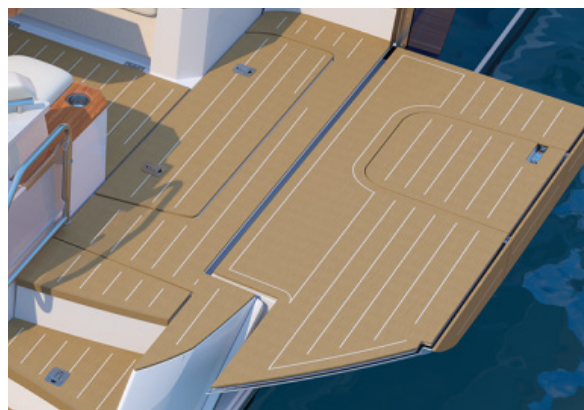

*Hullside terrace deployed*

## To retrieve the folding terrace:

1. Be sure that all persons and belongings are removed from the terrace surface.
2. Press and hold the UP button on the outboard gunwale switch panel. The alarm will begin to sound immediately and the folding terrace will begin to retract.
3. Hold the UP button while the terrace returns to the full and upright position, until the locking pin is fully extended. When the locking pin is in the fully locked position, the pump motor and alarm will stop.
4. When the folding terrace has returned to its full upright and locked position and the motor has stopped, depress the TERRACE DOOR button on the helm switch panel to deactivate the system.

**DANGER**

**Before attempting to retrieve the folding terrace, ensure that all persons and belongings are removed from the terrace surface. Failure to comply could result in serious injury, death, or property damage.**

## Television and Stereo

Raise and lower the optional cockpit TV, if installed, using the buttons on the port alfresco cockpit switch panel. A television antenna is installed on the hardtop.

Your Tiara is equipped with three stereo systems. The salon stereo control head operates the foredeck, interior salon, alfresco cockpit, and aft cockpit speakers. The foredeck lounge and alfresco cockpit are equipped with remote units that may also be used to control the salon and cockpit stereo system.

The boat's three stereo systems and all the boat's speakers may be networked together using the Garmin OneHelm™ or the Fusion-Link™ app on your mobile device. Refer to the Fusion stereo system user's manual for additional operating information.

## Floor Boxes

Insulated port and starboard floor boxes are equipped with macerator pumps for removing water. Press and hold the buttons on the port alfresco cockpit switch panel to operate either pump. The floor boxes contain drain fittings that should be inspected frequently to remove any accumulated debris.

## Aft Cockpit Weather Covers

Weather covers are provided to protect the aft cockpit seating when the boat is not in use. Snap the covers into place before leaving the boat. Remove and securely stow the covers before operating the boat.

## 7.5 Exterior Galley

The aft cockpit buffet features a sink, refrigerator, grill, and optional ice maker.

### Refrigerator

To operate the dual-voltage drawer refrigerator, switch ON the COCKPIT REFRIGERATOR breakers on the AC and DC distribution panels, installed in the third stateroom electrical cabinet.

The refrigerator temperature is controlled using the thermostat inside the unit. Refer to the refrigeration system owner's manual for more information.

### Ice Maker (optional)

An ice maker may be installed in the aft galley. To operate, the ICEMAKER breaker on the AC distribution panel must be switched ON.

### Grill

A 120/230V electric grill is installed on the buffet countertop; the grill cover opens and locks into place.

To use the grill, the DECK GRILL breaker on the AC distribution panel must be ON. Turn the breaker OFF whenever the grill is not being used.

Never clean the grill with any form of pressurized water or other types of cleaners. Use only a cloth and a stainless steel or glass surface cleaner. This grill, like all appliances, has the potential to create safety hazards through careless or improper use. Observe all of the safety precautions listed in the grill owner's manual.

### To operate the electric grill:

- Raise the lid.
- Switch ON the DECK GRILL breaker on the AC distribution panel.
- Turn the grill ON using the controls built into the grill unit.

When finished, let the grill cool, clean the top, empty the drip pan contents, and lower the lid. Lowering the lid on the grill activates a safety switch that turns the DECK GRILL breaker OFF.

The grill breaker is protected by a ground fault circuit interrupter, or GFCI, which will cut off power to the grill if it identifies a change in the amount of electricity flowing through the circuit, thereby preventing electrocution. If the DECK GRILL breaker on the AC distribution panel is turned on but the grill is not powered, check the GFCI and reset if necessary.

On boats equipped with the aft lounge module, the grill GFCI is installed inboard of the grill under the center countertop in the transom storage compartment. On boats equipped with the adventure module, access the grill GFCI by pulling the sliding wastebasket out and opening the starboard cabinet inside. Refer to the grill owner's manual for more information.

## WARNING

**Severe burns can occur from the improper use of this device. Do not leave the grill unattended when it is hot. Close supervision is required when the grill is being used or is hot. Do not use the grill while underway.**

## NOTICE

**After cooking, clean the grill surface. Empty the contents of the drip pan located below the grill. Lift the grill grate up and carefully remove the fully cooled drip pan. Allow the grill to cool off before closing the lid. Failure to do so could result in damage to the grill or grill area.**

## NOTICE

**Do not close the grill lid over a warm grill. Allow the grill to cool completely before covering. Failure to do so could result in damage to the lid and grill.**

### Sink

The cockpit sink drains by gravity to overboard thru-hulls. All of the boat's drain fittings should be inspected frequently to remove any accumulated debris. See section 5.

### 7.6 Stern

#### Transom Doors

Do not use the transom doors when the boat is in motion. DO NOT leave the transom doors unlatched. Always latch the doors in the fully CLOSED position while the boat is underway. Latch them in the fully OPEN position or fully CLOSED position when the boat is not underway.

## CAUTION

**Periodically inspect transom doors/gates fittings for wear, damage or loose fit. Repair or replace before using your boat.**

**NOTICE**

Acrylic plastic scratches easily. Use a soft cloth and mild soap and water for routine cleaning. **DO NOT** use a dry cloth, abrasives, or glass cleaning solutions on acrylic. Solvents and products containing ammonia can permanently damage acrylic plastic.



Water connection cabinet

The transom doors feature a clear acrylic panel. Use a soft cloth and mild soap and water for routine cleaning. **Do not use abrasive cleaners. Solvents and products containing ammonia, such as Windex®, can permanently damage acrylic plastic.**

**Shorepower Cabinet**

The aft shorepower cabinet is located under the lower starboard transom step. The cabinet contains the shorepower breaker, ELCI power reset button, Glendinning power cable reel switch, shore power cable, and dockside cable TV inlet. The ELCI (equipment leakage current interrupter) uncouples the boat's power system from shore power if a problem is detected. Use the ELCI power reset button to restore power if it has been tripped. See chapter 4 for electrical systems information.

Use the Glendinning power recoil switch to release or retrieve the shorepower cable. Place the switch in the middle position when not moving the cable. See section 4, Electrical Systems, for more information about connecting to shore power.

**CAUTION**

When routing electric cables and dockside water hoses from the boat to the dock, be sure to allow sufficient slack so cables and hoses will not be strained in any way as the boat moves within its slip. Do not allow cables or hoses to dangle into the water.

**Water Connection Cabinet**

The aft water connection cabinet is installed under the lower port transom step. The cabinet contains the dockside fresh water connection, fresh water washdown connection, and raw water washdown connection. To use a washdown connection, the WASHDOWN PUMP on the DC distribution panel must be ON.

The fresh water washdown uses water from a dockside water source. When a hose from the dock is attached and pressurized, your boat's fresh water system will be supplied using water from the dock, not the onboard fresh water tank. The fresh water inlet has a built-in regulator.

The raw water washdown draws sea water from a thru-hull installed in the hull bottom. See section 5, Plumbing, for more information.

**Transom Shower**

**DANGER**

**CARBON MONOXIDE POISONING AND/OR ROTATING PARTS HAZARD**  
 Poisonous CO gases are present at the rear of the boat when an engine is running. A rotating propeller can cut or entangle swimmers. Either of these hazards will cause death or serious injury. **DO NOT** use the swim/boarding platform when the engine is running.

A fresh water shower is located outboard of the port transom gangway. It is supplied hot and cold water by the fresh water system and water heater.

To operate, switch ON the FRESH WATER PUMP breaker(s) on the DC distribution panel in the third master stateroom electrical cabinet and the WATER HEATER breaker on the Master AC Panel in the engine room. Pull the shower wand out of the holder and twist to start the flow of water and adjust the temperature. Before placing the wand back in the holder, ensure the wand is shut OFF completely. Failure to do so will cause the fresh water pump to run and water to leak into the bilge.

### Transom Storage Trunk

The transom storage trunk is located under the transom buffet. Lines, fenders, and other items may be accessed quickly by raising the countertop.

The trunk contains additional storage space; an AC power outlet; access to the hydraulic swim platform lift system pump; the Volvo® IPS drive units (via the port and starboard floor hatches in the trunk); and access to the aft mechanical space and bilge pump (via the center trunk's center floor hatch).



### NOTICE

**Oil to the refrigerator compressor unit will not circulate when the transom buffet is raised, which may result in compressor failure. Turn off power to the refrigerator and optional ice maker, if installed, before raising the transom buffet for any length of time.**

To access the buffet trunk:

- Be certain all people (including the operator), pets, and items are cleared away from and not positioned aft of the transom buffet. The hatch will open aft and up.

- Turn off power to the aft galley refrigerator and optional ice maker, if installed. NOTE: Refrigeration compressor oil will not circulate when the transom buffet is raised. To prevent compressor damage, turn off power to the refrigerator and ice maker (if installed) before raising the transom buffet. To do so, switch OFF the COCKPIT REFRIGERATOR breaker and ICE MAKER breaker (if installed) on the AC distribution panel and the COCKPIT REFRIGERATOR breaker on the DC distribution panel.
- Use the TRUNK LIFT UP and DWN buttons, installed inboard of the starboard transom steps, to raise and lower the buffet to access the trunk.

The transom trunk light will automatically turn on and off when the transom buffet is raised and lowered.



### WARNING

**Fuel vapors are a fire and explosion hazard that can result in serious injury, burns, or death. Do not store containers of fuel or other flammable liquids in the transom storage compartment or the engine room.**



### CAUTION

**When raising the transom storage hatch make sure no items are placed on the buffet. Make sure nobody is standing aft of the transom storage compartment. Failure to do so could result in damage or injury.**

### Hydraulic Swim Platform

Your boat is equipped with a hydraulic swim platform lift system that raises and lowers the swim platform. Always be sure the swim platform is in the UP and LOCKED position prior to getting underway.



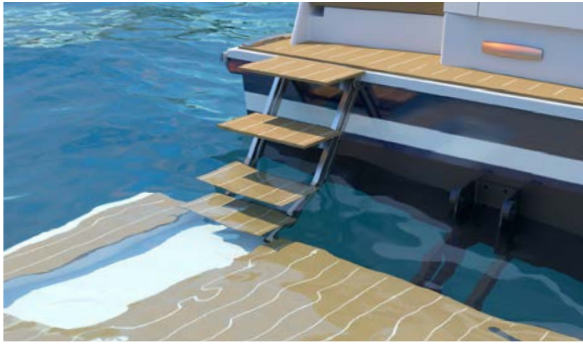

*Hydraulic swim platform with stairway*

The swim platform hydraulic power unit is located inside the transom storage trunk. Before operating the swim platform lift system, switch ON the HYDRAULIC SYSTEM breaker on the side of the Master DC panel box in the engine room.

Raise and lower the swim platform using the SWIM LIFT UP and DWN buttons installed inboard of the starboard transom steps. **NOTE:** Before operating this switch, be certain all people (including the operator), pets, and items are cleared away from and not standing on the swim platform. Be aware of pinch points and people and objects located around the swim platform. Refer to the platform owner's manual for more information.

The integrated disappearing stairway automatically deploys when the platform is lowered.

DO NOT use the swim platform or stairway while engines are running. All engines must be OFF when swimmers are in the water and before allowing anyone to enter or exit the boat.



## DANGER

**CARBON MONOXIDE POISONING AND/OR ROTATING PARTS HAZARD**  
Poisonous CO gases are present at the rear of the boat when an engine is running. A rotating propeller can cut or entangle swimmers. Either of these hazards will cause death or serious injury. **DO NOT** use the swim/boarding platform when the engine is running.

### Stern Cleats

Cleats and/or pop-up cleats are installed at the stern of your boat. The cleats are designed to handle the loads associated with mooring your boat. **Do not use these cleats for towing.**



## WARNING

The cleats on your boat have not been designed for, nor are they intended for, towing. Using them for this purpose could result in personal injury or damage to your boat. Refer to *Chapman Piloting & Seamanship* for proper towing procedures.



Interior Equipment

8.1 Safety Equipment

Familiarize yourself with the safety equipment found in the cabin. Fire extinguishers are stored in the master stateroom port hanging locker, the forward VIP stateroom starboard hanging locker, and the third stateroom starboard hanging locker. A carbon monoxide detector and smoke detector are installed in each berth.

Read about carbon monoxide, its hazards, and the carbon monoxide detector in section 9, Safety Information.

 <b style="font-size: 1.2em; margin-left: 10px;">WARNING</b>
<p><b>The carbon monoxide monitoring system is only a supplemental safety aid. Make sure you follow all safety procedures found in this manual. Carbon monoxide is a lethal, toxic gas that will cause death at certain levels.</b></p>

8.2 Helm

Helm Console

The helm console is the main operating position on your boat. See section 2, Helm Systems, for more information. A lower glovebox on the port side of the helm console houses the Fireboy status indicator and override button (see section 2 for more information); climate control panel; and USB charging ports.

Helm Seat

The helm seat and footrest can be adjusted using the switches installed outboard of the seat cushion. Use the fore/aft switch to adjust the helm seat position, and the up/down switch to position the footrest.

The outboard helm seat armrest houses the joystick and Garmin GRID; see section 2 for more information. The starboard armrest slides fore and aft to accommodate different

driving positions. Push the armrest button to release the slide and move the armrest forward or aft until it locks into position.



*Armrest with positioning button to inboard*

Electrically Actuated Pilot House Door

The starboard pilot house door can be opened or closed to provide increased ventilation or protection from weather. Buttons for controlling the door are installed just outboard of the starboard helm console and on the starboard exterior bulkhead just forward of the door. Use either aft button to open the door and either forward button to close the door.

Power to the door motor will be automatically shut off if the unit senses an obstruction. Remove the obstruction, press the appropriate button to move the door a bit in the opposite direction, then open or close the door as desired.

Powered Sunroof

The hardtop features a sunroof above the helm. Press and hold the SUNROOF OPEN and CLOSE buttons on the helm to operate.

In the event power to the sunroof is lost or the motor malfunctions, pull down the headliner panel on centerline (immediately aft of the sunroof opening) and use a hex key wrench to manually close the sunroof.

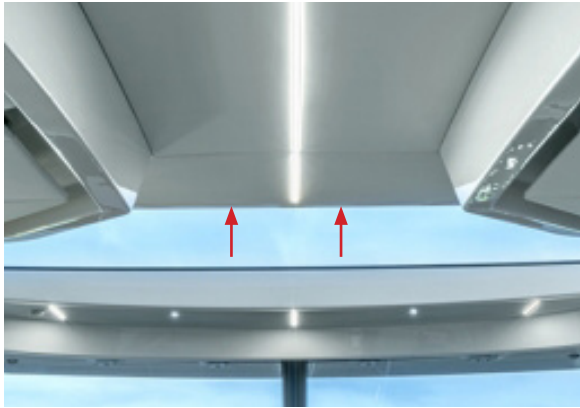

*Arrows indicate the sunroof headliner panels to remove to operate the sunroof in case of power outage*

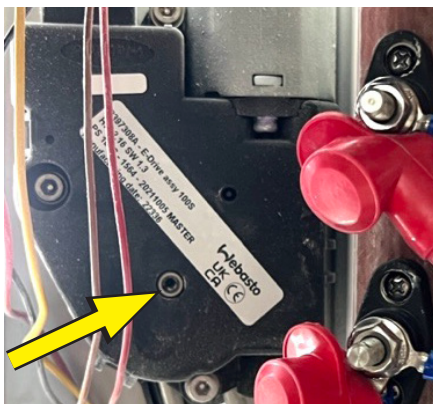

*Insert hex key wrench to manually close the sunroof*

### VHF Radio

The VHF radio is located on the starboard side of the helm console.

### Air Conditioning

The helm air conditioning can be controlled using the control panel installed in the port helm glovebox. Refer to the climate control information in section 6, Ventilation Systems.

## 8.3 Salon and Galley

The port side lounge features seating with storage below and a leafing dinette table. The end table lamps may be operated using switches installed outboard of the forward lamp.

Salon and galley windows are equipped with electronic blinds that may be raised or lowered using the provided remote control(s).

The starboard galley includes a sink, microwave/convection oven, induction cooktop, dual-drawer refrigerator/freezer units, solid surface countertop, storage drawer, wastebaskets, and TV. If installed, the optional garbage disposal can be operated using the switch found on the aft face of the flip-top cabinet outboard of the sink. A storage space in the galley backsplash houses power outlets and HDMI connections to connect gaming and video devices to the TV.

### Induction Cooktop

Use only induction-compatible cookware on the cooktop. Refer to the cooktop user's manual for usage and cleaning instructions.

### Refrigerator/Freezers

To operate the dual-voltage drawer refrigerator/freezers, switch ON the REFRIGERATOR breakers on the AC and DC distribution panels, installed in the third stateroom electrical cabinet.

Each drawer unit may be used as either a refrigerator or a freezer; control the temperature using the thermostat inside each unit. Refer to the refrigeration system user's manual for more information.

### Television

A television mounted on a hi-lo actuator is installed in the starboard galley. Deploy by pressing the TV LIFT button on the starboard galley bulkhead.

### Stereo

Your Tiara is equipped with three stereo systems. The salon stereo control head operates the foredeck, interior salon, alfresco cockpit, and aft cockpit speakers.

The boat's three stereo systems and all the boat's speakers can be networked by using the Garmin OneHelm™ or the Fusion-Link™ app on your mobile device. Refer to the Fusion stereo system user's manual for additional operating information.

## Air Conditioning

The salon air conditioning system may be controlled using the thermostat installed in the forward galley cabinet. Refer to the climate control information in section 6, Ventilation Systems.

## Vertically Retracting Glass Window

The glass partition separating the salon and galley from the exterior alfresco cockpit consists of a starboard window panel and three centerline door panels. To raise or lower the vertical glass, use the buttons installed on the galley's forward-facing bulkhead.

To open the door from inside the galley, push the knob to release the door. To lock the door, rotate the locking lever counter-clockwise from the vertical position to the horizontal position. To open the door from the exterior, pull the knob to release the door. To lock the door, use the provided key in the outside knob keyhole.

### CAUTION

**Keep the aft bulkhead panel doors latched in the open or closed position at all times. If the panels are unlatched, they could slide unexpectedly as the boat rocks, causing injury or damage.**

## 8.4 Lighting

Galley and salon lighting may be controlled using the switches at the top of the cabin stairway and on the starboard aft galley bulkhead. Hardtop and accent lighting may be controlled using the Garmin OneHelm dis-

play. See on-screen instructions for more information.

Switches installed in the starboard galley control the dimmable overhead salon and galley lights; press to switch the lights on or off, and press and hold to adjust brightness.

Light switches on the companionway staircase starboard bulkhead may be used to control the dimmable salon overhead lighting, galley courtesy lighting, atrium overhead lighting, and companionway accent lighting.

Light switches on the port forward-facing wall of the cabin atrium control stairway access lighting, atrium lights, and forward and aft stateroom lights.

Indirect handrail lighting may be controlled using switches at the top of the cabin stairway.

## 8.5 Master Stateroom

The master stateroom features a storage compartment below the berth, which includes space for the provided Dyson vacuum cleaner and charger. To access the compartment, lift the aft end of the mattress base.

Hullside windows are equipped with powered blinds, which may be operated using the provided remote controls.

Turn the mirror's lights on and off using the lighted blue on/off button on the mirror. To disable the blue on/off light, use the switch in the upper area of the port side master stateroom hanging locker (near the stereo and air conditioning control). This switch will disrupt power to the mirror so it will no longer light (and the blue on/off light will not be visible).

Atrium lighting may be controlled using the switches at the top of the stairway, and in the master and VIP staterooms.

Master stateroom lighting may be controlled using switches on the inboard hallway bulkhead and either side of the berth.

Touch-activated reading lights are installed on each side of the berth; touch to select white or red light or to turn off.

Wireless charging pads are located on each nightstand. The round, black pads may be used to charge compatible devices.

The climate control pad in the master stateroom port aft hanging locker may be used to control the master stateroom, master head compartment, and VIP head compartment air conditioning. See section 6, Ventilation Systems, for more information.

### Television and Stereo

A television is installed in the starboard master stateroom. Refer to the TV user's manuals for operating information. A television antenna is installed on the hardtop.

The Fusion® stereo control head installed in the master stateroom port hanging locker may be used to operate the master stateroom speakers. To network all the boat's speakers together, use the Garmin OneHelm™ or the Fusion-Link™ app on your mobile device. Refer to the Fusion stereo system user's manual for additional operating information.

### Vacuum

A Dyson stick vacuum and charger are stored under the master berth; lift the aft end of the mattress base to access.

### Washer and Dryer (Optional)

If equipped, a washer and dryer are installed in the master stateroom. See the provided user's manuals for more information.

## 8.6 Master Head Compartment

The master head compartment is equipped with a toilet, fresh water sink with faucet, shower, exhaust fan, operable port light, storage, and waste basket. Secure the head compartment door in the closed position whenever the boat is underway to prevent damage to the door.

A GFCI-protected AC duplex outlet is provided in the head compartment. See section 4, Electrical Systems, for more information.

An opening portlight provides daylight and ventilation. The countertop may be made of Corian®. Refer to section 11, Routine Maintenance, for Corian care information.

When the FRESH WATER PUMP breaker (s) on the DC distribution panel is on, the water system will operate much like a home water system. Refer to section 5, Plumbing Systems, for more information on operating the system. For care and cleaning information, refer to section 11, Routine Maintenance.

## 8.7 Forward VIP Stateroom

Light switches are located on the starboard bulkhead and on either side of the berth.

An inductive cellphone charging pad is located on each nightstand. The round, black pad may be used to charge compatible devices.

Use the climate control pad in the upper port cabinet to control the VIP stateroom air conditioning. See section 6, Ventilation Systems, for more information.

### Television and Stereo

A TV is installed on the forward stateroom starboard bulkhead. The television antenna is installed on the hardtop.

The Fusion® stereo control head installed in the VIP stateroom upper port cabinet may be used to operate the VIP stateroom speakers. To network all the boat's speakers together, use the Garmin OneHelm™ or the Fusion-Link™ app on your mobile device. Refer to the Fusion stereo system user's manual for additional operating information.

## 8.8 VIP Head Compartment

The VIP head compartment is equipped with a toilet, fresh water sink with faucet, shower, exhaust fan, operable port light, storage, and

waste basket. Secure the head compartment door in the closed position whenever the boat is underway to prevent damage to the door.

The climate control panel in the master stateroom port aft hanging locker may be used to control the VIP head air conditioning. An opening portlight provides daylight and ventilation. A GFI-protected duplex outlet is provided in the head compartment.

The countertop may be made of Corian®. Refer to section 11, Routine Maintenance, for Corian care information.

When the FRESH WATER PUMP breaker(s) on the DC distribution panel is on, the water system will operate much like a home water system. Refer to section 5, Plumbing Systems, for more information on operating the system. For care and cleaning information, refer to section 11, Routine Maintenance.

## 8.9 Third Stateroom

The third stateroom features two twin berths (with storage compartments below) that slide together to form a full-size berth. Use the button on the forward face of the inboard berth to combine and separate the berths: press, release, and slide the berth, and lock into place using the latch.

Light switches are located forward of the starboard hanging locker and between the berths. An inductive cellphone charging pad is located on the nightstand. The round, black pad may be used to charge compatible devices.

The climate control pad in the VIP stateroom controls the third stateroom air conditioning. See section 6, Ventilation Systems, for more information.

## Electrical Cabinet

The boat's AC and DC distribution panels are located in the third stateroom aft overhead cabinet. See section 4, Electrical Systems, for more information.

## Television

A TV is installed on the third stateroom's forward bulkhead. The television antenna is installed on the hardtop.

Refer to the TV owner's manuals for operating information.

## 8.10 Marine Head System

Your boat is equipped with a VacuFlush® electric flush marine head system. Before using the toilet, ensure the VACUUM PUMP breaker(s) on the DC distribution panel is ON. For more information, see section 5, Plumbing Systems, and the head system owner's manual.

## Holding Tank Monitor

The holding tank monitor is located on the System Monitor screen of the power-up panel, installed on the port helm console. The indicators on this panel display the fresh water and waste holding tank levels. See the head owner's manual for more information.

## 8.11 Access to Components

The shower sump box, holding tank overboard discharge valve, and the pump for the forward bilge pump may be accessed via the master stateroom hallway floor hatch. The forward bilge pump pick-up is remotely mounted under the removable floor panel in the master hallway hanging locker.

The Vacuflush system pumps, waste holding tank, and holding tank vent filter may be accessed via the floor hatch in the cabin atrium. See section 5, Plumbing Systems, for more information.





Safety Information

9.1 General

Your boat and outboard engines have been equipped with safety equipment designed to enhance the safe operation of the boat and to meet U.S. Coast Guard safety standards. The Coast Guard and state, county, and municipal law enforcement agencies require certain additional accessory safety equipment on each boat. This equipment varies according to length and type of boat and type of propulsion. Most of the accessory equipment required by the Coast Guard is described in this section. Some local laws require additional equipment. Read *A Boat-er's Guide to the Federal Requirements for Recreational Boats*, published by the US Coast Guard and included with this manual, and obtain copies of state and local laws, to make sure you have the required equipment for your boating area. Visit [www.uscgboating.org](http://www.uscgboating.org) for more information. We also strongly recommend reading the latest edition of the book *Chapman Piloting & Seamanship*.

Your boat may be equipped with engine alarms and cabin monitoring equipment. These systems are designed to increase your boating safety by alerting you to potentially serious problems in the primary power systems, the engine compartment and the cabin. Alarm systems are not intended to lessen or replace good maintenance and a pre-cruise system check. Refer to the *Pre-Cruise Checklist* at the start of this manual, and sections 11 and 12 for maintenance information.

This section describes safety-related equipment that could be installed on your boat, depending on the type of engines and other options installed by you or your dealer.

9.2 Engine Alarms

Most outboards are equipped with an audible alarm system mounted in the helm area that monitors selected critical engine systems. The alarm will sound if one of these systems begins to fail. Refer to the engine owner's

manual for information on the alarms installed with your engines, as well as additional operating and maintenance information.

If the alarm sounds:

- Throttle the engines back to idle immediately.
- Shift to neutral.
- Monitor the engine gauges to determine the cause of the problem.
- If necessary, shut off the engines and investigate until the cause of the problem is found.
- If the boat is equipped with water sensors in the fuel filters, make sure to check them for excessive water.

9.3 Neutral Safety Switch

Every throttle/shift control system has a neutral safety switch. The switch allows the engines to be started in NEUTRAL only. If engines will not start, make sure controls are in NEUTRAL. Refer to section 2 for neutral safety switch information.

9.4 Engine Stop Switch

Your Tiara Yacht is equipped with an engine stop switch, clip and lanyard. When the lanyard is pulled, it will shut off the engines.

 <b>WARNING</b>
<p><b>LOSS OF CONTROL AND UNSAFE BOAT HAZARD</b></p> <p><b>An engine stop switch system that is not used or does not function correctly can cause death or serious injury. DO NOT operate the boat if the stop switch system does not function properly.</b></p>

The stop switch will stop an engine whenever the lanyard is pulled far enough to disconnect the clip from the switch. Attach the lanyard to the boat operator whenever an engine is running, but be aware of loss of engine power if the switch is activated.

If the operator is thrown from the seat, or moves too far from the helm, the lanyard will disconnect the clip from the switch, shutting off the engine.

To attach a lanyard, connect the clip to the emergency stop switch and the hook to a strong piece of clothing on the operator, such as a belt loop.

If the engines will not start, check to see if the clip isn't inserted into the engine stop switch properly or the control is not in neutral. Make sure the clip is properly attached to the engine stop switch before attempting to start the engine.

Always carry a spare stop switch clip and lanyard and instruct at least one other person onboard regarding the operation of the stop switch and location of the spare.

## 9.5 Fire Safety

### Fire Extinguishers

Coast Guard-approved fire extinguishers are hand-portable, either B-I or B-II classification, and have a specific marine-type mounting bracket. It is recommended the extinguishers be mounted in a readily accessible position. Your Tiara Yacht comes equipped with the fire extinguishers inside the:

- starboard galley sink cabinet
- aft cockpit starboard aft-facing seat base
- master stateroom hanging locker
- VIP stateroom hanging locker
- third stateroom hanging locker

Check fire extinguishers at the start of each season and have them charged or replaced as necessary.

#### Fire extinguishers require regular inspections to ensure:

- Seals and tamper indicators are not broken or missing.

- Pressure gauges or indicators read in the operable range.
- There is no obvious physical damage, corrosion, leakage or clogged nozzles.

For information on the type and size fire extinguisher required for your boat, visit [uscgboating.org](http://uscgboating.org) or refer to *A Boater's Guide to Federal Requirements for Recreational Boats*, provided with this manual.

Information about halon or agent FE-241 extinguishers is provided by the manufacturer. It is extremely important that you learn about and understand and know how this system works; refer to the manufacturer's literature.

### Automatic Generator Fire Extinguishing System

If your boat is equipped with a generator, an automatic fire extinguishing system is installed. It is extremely important that you learn about and understand how this system works; refer to the manufacturer's owner's manual for additional information.



## WARNING

**If a mechanical space fire should occur, turn off all main electrical switches and shut down the generator. Do not open the engine access hatch. Allow the fire extinguisher chemical to soak the engine compartment for at least fifteen (15) minutes.**

The generator fire suppression system is located overhead in the mechanical space, just aft of the generator, and operates automatically. The extinguisher has been chosen and located to provide sufficient coverage of the generator compartment. While the system helps ensure bilge fire protection, it does not eliminate the U.S. Coast Guard requirement for hand held fire extinguishers.

The manual discharge pin is located below the center helm seat, on the forward face of the seat box. To manually discharge the fire suppression system, remove the pin and pull the red handle.



*Fire system manual discharge pull*

After the fire suppression system discharges, turn on the BLOWER switch at the helm and operate the generator blower for five minutes. Open the mechanical space to evacuate the fire suppression agent and find and fix the problem.

To restart the engines, press the override button on the helm-mounted Fireboy system status indicator. Refer to the system owners manual for more information.



*Fire system status indicator and override button*

## WARNING

**FIRE/EXPLOSION HAZARD**

The gas of the fire extinguisher system displaces oxygen to “smother” the fire. **DO NOT** open the hatch. Oxygen can feed a fire and flashback can occur, which can cause death or serious injury. If the onboard fire system discharges, wait at least 15 minutes before opening engine hatch.

The system is equipped with an engine shutdown circuit to automatically shut down the generator. The red light on the Fireboy status indicator (on the helm) will light and an alarm will sound if this should occur. Shut down all engines immediately. Turn off all electrical systems and powered ventilation, and extinguish all smoking materials. **DO NOT** open the engine compartment hatch, because this will feed oxygen to the fire and allow a flashback to occur. Allow the extinguishing agent to soak the generator compartment for at least 15 minutes and wait for hot metals or fuels to cool before inspecting for cause or damage. Have an approved portable fire extinguisher at hand and ready for use and **DO NOT** breathe fumes or vapors caused by the fire.

## Bilge And Fuel Fires

Fuel compartment and bilge fires or explosions are dangerous because of the presence of fuel. You must make the decision to fight the fire or abandon the boat. If the fire cannot be extinguished quickly or it is too intense to fight, abandoning the boat may be your only option. You must consider your safety, the safety of your passengers, the intensity of the fire, and the possibility of an explosion in your decision.

If you find yourself in this situation, make sure all passengers have a life preserver, go over the side, and swim well upwind of the boat, to keep clear of any burning fuel that could be released and spread on the water as the boat burns or in the event of an explosion. When clear of the danger, check and account for all passengers who were onboard. Give whatever assistance you can to anyone in need or in the water without a buoyant device. Keep everyone together for morale and to aid rescue operations.

## 9.6 Carbon Monoxide Safety

### Carbon Monoxide Detector

A carbon monoxide detector is installed near the headboard of each berth. CO detectors warn occupants of dangerous accumulation of CO gas. If a carbon monoxide detector is activated, this indicates the presence of CO, which can be fatal. Evacuate the cabin immediately. Make sure all passengers are accounted for. DO NOT enter the cabin until you know it is safe to do so and the problem found and corrected.

The CO detector is powered by a 9V battery. A power light indicates that the detector is powered and working. Test the detector and replace the battery on a regular basis. Make sure the indicator light is on whenever the cabin is occupied.

This device uses a micro controller to continuously measure and accumulate CO levels. Should a very high level of CO exist, the alarm will sound within a few minutes. If small quantities are present or high levels are short-lived, the detector will accumulate the information and determine when an alarm level has been reached.

While a CO detector enhances your protection from CO poisoning, it does not guarantee it will not occur. Do not use CO detectors as a replacement for ordinary precautions or periodic inspections of equipment. Never rely on alarm systems to save lives; common sense is still the best form of protection. Remember, the boat operator carries the ultimate responsibility to make sure the boat is properly ventilated and passengers are not exposed to dangerous levels of CO. Be alert to the symptoms and early warning signs of carbon monoxide.

CO detectors are very reliable and rarely sound false alarms. If the alarm sounds, DO NOT think it is false. If anyone has been exposed to CO, move them into fresh air immediately.

Contact the detector manufacturer, Tiara Yachts Customer Relations, or your local fire department for assistance in finding and correcting the situation. Never disable the CO detector because you think the alarm may be false.

### Carbon Monoxide Hazards

Carbon monoxide (CO) is a by-product of combustion, is invisible, tasteless and odorless, and is produced by all engines and most heating and cooking appliances. It exists wherever fuels are burned to generate power or heat.

The most common sources of CO on boats are combustion engines, auxiliary generators, and propane or butane stoves. These produce large amounts of CO and should never be operated while sleeping. High concentrations of CO can be fatal within minutes. Many cases of CO poisoning indicate that while victims are aware they are not well, they become so disoriented they are unable to save themselves by either exiting the area or calling for help. Young children, elderly persons, and pets may be the first affected. Drug or alcohol use increases the effect of CO exposure. Individuals with cardiac or respiratory conditions are very susceptible to the dangers of CO. Carbon monoxide poisoning is especially dangerous during sleep while victims are unaware of any side effects.

Low levels of CO over an extended period of time can be just as lethal as high doses over a short period. Therefore, low levels of CO can cause the carbon monoxide detector to sound before persons notice any symptoms.

### Carbon Monoxide Symptoms

All engines and fuel burning appliances produce CO as exhaust. Direct and prolonged exposure to CO will cause BRAIN DAMAGE or DEATH.

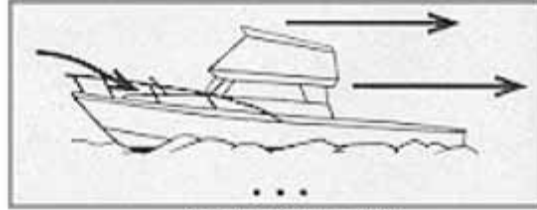

OPERATING SAFELY

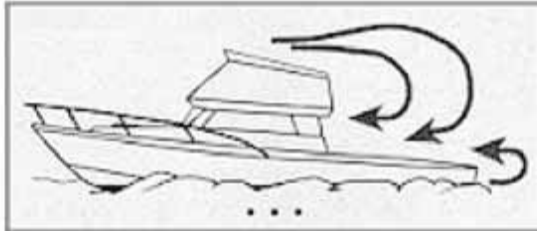

BACK DRAFTING / STATION WAGON EFFECT

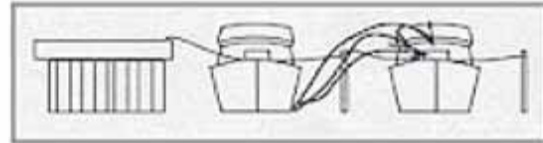

NEARBY BOAT GENERATOR EXHAUST

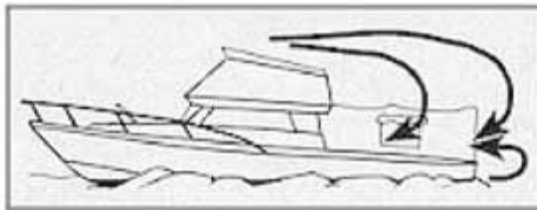

BACK DRAFTING / STATION WAGON EFFECT

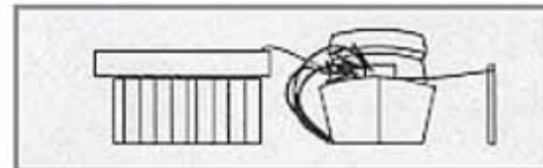

ONBOARD BOAT GENERATOR EXHAUST

Carbon monoxide (CO) poisoning is lethal and should not be confused with seasickness, intoxication, or heat exhaustion. If someone complains of irritated eyes, headache, nausea, weakness, or dizziness, or you suspect carbon monoxide poisoning, immediately move the person to fresh air, investigate the cause, and take corrective action. Seek medical attention if necessary.

Other symptoms that may signal exposure to CO: dizziness, flushed face, ears ringing, headaches, tightness of chest or hyperventilation, drowsiness, fatigue or weakness, inattention or confusion, lack of normal coordination, nausea, and unconsciousness. The victim's skin also may turn red. A slight buildup of CO in the human body over several hours causes headache, nausea, and other symptoms similar to food poisoning, motion sickness, or the flu. Anyone with these symptoms should immediately be moved to an area of fresh air. Have the victim breath

deeply and seek immediate medical attention. To learn more about CO poisoning, contact your local health authorities.

**DANGER**

**CARBON MONOXIDE (CO) HAZARD**  
**Exposure to CO will cause death or serious injury. CO is colorless, odorless and extremely dangerous. Avoid CO exposure and make sure the CO detector is working properly.**

**Preventing Carbon Monoxide Poisoning**

In certain situations, boats can have a problem due to the "station wagon effect" where engine exhaust fumes are captured in the vessel by the vacuum or low pressure area (usually the cockpit, helm, and cabin) that can be created by the forward speed of the

boat. When underway, all aft facing port-holes, hatches, and doors should be closed. Forward-facing deck hatches should be open whenever possible to help pressurize living spaces of the boat. Sleeping, particularly in aft cabins, should not be permitted while underway. Proper ventilation must be maintained at the helm by opening a forward window or windshield to drive fumes away from the occupants.

Use extreme caution when operating an auxiliary power generator while anchored or in a slip. Fumes can enter the boat easily on nights with calm wind. Inspect the exhaust systems of propulsion and the auxiliary generators, if equipped, frequently for possible leaks. High concentrations of CO in your boat can originate from an adjacent boat through open hatches or windows.

Failure to properly ventilate the boat while the engines are running can cause CO to accumulate within the cabin. Make sure to ventilate the boat and to avoid CO from accumulating in the boat whenever an engine is running.

Read the pamphlet *Carbon Monoxide Poisoning: What You Can't See*, included with this manual, and the owner's manual supplied by the CO detector manufacturer for additional information regarding the hazards and symptoms of CO gas, CO poisoning, and operation instructions. If you did not receive these manuals, contact Tiara Yachts Customer Relations.

CO detectors have a limited life span; follow the CO detectors manufacturers recommendations on when the detector must be replaced.

### 9.7 First Aid

It is the boat operator's responsibility to be familiar with proper first-aid procedures and able to care for minor injuries or illness of your passengers. In an emergency, you could be far from professional medical assistance,

so be prepared. We recommend you be prepared by receiving training in basic first aid and CPR, through classes given by the American Red Cross or your local hospital.

Equip your boat with at least a simple marine first-aid kit and a first-aid manual. The marine first-aid kit should be designed for the marine environment and be well supplied. Keep it accessible so each person onboard knows where it is located. As supplies are used, replace them.

Ask a medical professional about the supplies you should carry and the safe shelf life of prescription drugs or other medical supplies you carry. Some common drugs and antiseptics can lose their strength or become unstable as they age. Replace old supplies whether they have been used or not.

In many emergency situations, the US Coast Guard can provide assistance in obtaining medical advice for treatment of serious injuries or illness. If you are within VHF range of a Coast Guard station, make the initial contact on channel 16 and follow their instructions.

### 9.8 Required Safety Equipment

In addition to items installed by Tiara Yachts, certain other equipment is required by the U.S. Coast Guard to help ensure passenger safety. Items like a sea anchor, working anchor, extra dock lines, flare pistol, life vests, or a line permanently secured to your ring buoy could at some time save your passengers' lives, or save your boat from damage. Visit [www.uscgboating.org](http://www.uscgboating.org) for a more detailed description of the required equipment and for information about boat safety courses. Check your local and state regulations as well.

The Coast Guard Auxiliary offers a courtesy inspection that will help ensure your boat is equipped with all of the necessary safety equipment. Visit [uscgboating.org](http://uscgboating.org) for details.

The following is a list of the accessory equipment required on your boat by the U.S. Coast Guard. Requirements are subject to change.

### Personal Flotation Devices (PFDs)

PFDs must be Coast Guard approved, in good and serviceable condition, and of appropriate size for the intended user. Wearable PFDs must be readily accessible, meaning you must be able to put them on in a reasonable amount of time in an emergency. Though not required, the Coast Guard emphasizes that PFDs should be worn at all times when the vessel is underway. Throwable devices must be immediately available for use. All boats must be equipped with at least one Type I, II or III PFD for each person onboard, plus one throw-able device (Type IV).

### Visual Distress Signals

All boats used on coastal waters, the Great Lakes, territorial seas, and those waters connected directly to them, must be equipped with Coast Guard approved visual distress signals. These signals are either Pyrotechnic or Non-Pyrotechnic devices.

### Pyrotechnic Visual Distress Signals

Pyrotechnic visual distress signals must be Coast Guard approved, in serviceable condition and readily accessible. They are marked with a date showing the service life, which must not have expired. A minimum of three are required. Some pyrotechnic signals meet both day and night use requirements. They should be stored in a cool, dry location. They include:

- Pyrotechnic red flares, hand held or aerial.
- Pyrotechnic orange smoke, hand-held or floating.
- Launchers for aerial red meteors or parachute flares.

Pyrotechnics are universally recognized as excellent distress signals. However, there is potential for injury and property damage if not handled properly. These devices produce a very hot flame and the residue can cause burns and ignite flammable material. Pistol launched and hand-held parachute flares and meteors have many characteristics of a firearm and must be handled with caution. In some states they are considered a firearm and prohibited from use. Make sure you are careful and follow the manufacturer's instructions when using pyrotechnic distress signals.

**WARNING**

**FIRE/EXPLOSION HAZARD**

**Pyrotechnic signaling devices can cause fire and/or explosion, death, serious injury and property damage if misused. Follow the manufacturer's directions in the use of these signaling devices.**

**WARNING**

**BURN HAZARD**

**Fuel floating on water which is ignited can cause death or serious injury. Fuel will float on top of water and can burn. If the boat is abandoned, swim upwind, far enough to avoid fuel that can spread over the surface of the water.**

### Non-Pyrotechnic Devices

Non-Pyrotechnic visual distress signals must be in serviceable condition, readily accessible, and certified by the manufacturer as complying with U.S. Coast Guard requirements. They include:

### Orange Distress Flag, Day Use Only

The distress flag is a day signal only. It must be at least 3 x 3 feet with a black square and ball on an orange background. It is most distinctive when attached and waved from a paddle or boat hook.

### Electric Distress Light for Night Use

The electric distress light is accepted for night use only and must automatically flash the international SOS distress signal. Under Inland Navigation Rules, a high intensity white light flashing at regular intervals from 50-70 times per minute is considered a distress signal.

### Sound Signaling Devices

The navigation rules require sound signals to be made under certain circumstances. Recreational vessels are also required to sound fog signals during periods of reduced visibility. Therefore, you must have some means of making an efficient sound signal.

### Navigation Lights

Recreational boats are required to display navigation lights between sunset and sunrise and other periods of reduced visibility (fog, rain, haze, etc.) Navigation lights are intended to keep other vessels informed of your presence and course. Your Tiara Yacht is equipped with the navigation lights required by the U.S. Coast Guard at the time of manufacture. It is up to you to make sure they are visible, operational and turned on when required.

## 9.9 Additional Safety Equipment

Besides meeting the legal requirements, prudent boaters carry additional safety equipment. This is particularly important if you operate your boat offshore. You should consider the following items, depending on how you use your boat.

### Satellite EPIRBs

EPIRBs (Emergency Position Indicating Radio Beacon) operate as part of a worldwide distress system. When activated, EPIRB's will send distress code homing beacons that allow Coast Guard aircraft to identify and find them quickly. The satellites that receive and relay EPIRB signals are operated by the National Oceanic and Atmospheric Administration (NOAA) in the United States. The EPIRB should be mounted and registered according to the instructions provided with the beacon, so the beacon's unique distress code can be used to quickly identify the boat and owner.

### Additional equipment to consider:

- VHF Radio
- Life Raft
- Spare Anchor
- Spare Keys
- Heaving Line
- Fenders
- First Aid Kit
- Portable Radio
- Flashlight and Batteries
- Mirror
- Searchlight
- Sunburn Lotion
- Tool Kit
- Ring Buoy
- Whistle or Horn
- Anchor
- Chart and Compass
- Boat Hook
- Spare Propellers
- Mooring Lines
- Food and Water
- Binoculars
- Sunglasses
- Marine Hardware
- Extra Clothing
- Spare Parts



Operation

10.1 General

Before operating your boat, become familiar with the various component systems and their operation, and perform the Pre-Cruise Checklist found near the beginning of this manual. A thorough understanding of the component systems and their operation is essential to operate the boat safely. This owner’s manual and the associated manufacturers’ owner’s manuals have been provided to enhance your knowledge of your boat. Read them carefully.

We also recommend reading the latest edition of the book *Chapman Piloting & Seamanship*, which describes the best procedures for leaving and returning to the dock. Your boat must have the necessary safety equipment onboard and be in compliance with the U.S. Coast Guard, local and state safety regulations. There should be one Personal Flotation Device (PFD) for each person. Non-swimmers and small children should wear PFDs at all times.

You should know and understand the “Rules of the Road” and have had an experienced operator brief you on the general operation of your new boat. At least one other person should be instructed on the proper operation of the boat in case the operator is suddenly incapacitated.

For information about boating safety, regulations, and navigation rules, download the Boating Safety Mobile App from the US Coast Guard. Visit [www.uscgboating.org](http://www.uscgboating.org) for more information.

The operator is responsible for his or her safety and the safety of his passengers. When boarding or loading the boat, always step onto the boat, never jump. While maneuvering around the dock, have all guests on board remain in the cockpit or cabin areas, if they are not involved in the handling of mooring lines.

DO NOT allow passengers to sit on the seat backs, gunwales, bows, transoms, or sunpads when the boat is underway. Passengers should be seated to properly balance the load and must not obstruct the operator’s view, particularly to the front.

 <b>WARNING</b>
<p><b>DROWNING OR LOSS OF CONTROL HAZARD</b></p> <p>Ejection or sudden loss of control can cause death or serious injury from improper use of seating. <b>DO NOT stand while driving above engine idle speeds and make sure cockpit seating is locked/secured and all passengers are seated when boat is underway.</b></p>

Overloading and improper distribution of weight can cause the boat to become unstable and are significant causes of accidents. Know the weight capacity and horsepower rating of your boat. Do not overload or overpower your boat.

 <b>WARNING</b>
<p><b>OVERLOAD HAZARD</b></p> <p>Overloading the boat beyond maximum load or altering the stability, buoyancy or center-of-gravity can result in death or serious injury. <b>DO NOT exceed the maximum load or alter the center-of-gravity of the boat.</b></p>

Remember, it is the operator’s responsibility to use good common sense and sound judgment in loading and operating the boat.

 <b>WARNING</b>
<p><b>SLIPPERY SURFACE HAZARD</b></p> <p>Wet surfaces can generate slippery conditions which can result in death or serious injury. <b>Use caution on wet surfaces.</b></p>

## 10.2 Homeland Security Restrictions

**Recreational boaters have a role in keeping our waterways safe and secure. Violators of the restrictions below can expect a quick and severe response:**

- Do not approach within 100 yards, and slow to minimum speed within 500 yards of any U.S. Naval vessel. If you need to pass within 100 yards of a U.S. Naval vessel, for safe passage you must contact the U.S. Naval vessel or the Coast Guard escort vessel on VHF-FM channel 16.
- Observe and avoid all security zones.
- Avoid commercial port areas, especially those that involve military, cruise-line or petroleum facilities.
- Observe and avoid other restricted areas near dams, power plants, etc.
- Do not stop or anchor beneath bridges or in channels.

### America's Waterway Watch

America's Waterway Watch, a combined effort of the Coast Guard and its Reserve and Auxiliary, wants your help in keeping America's waterways safe and secure. America's Waterway Watch urges you to adopt a heightened sense of sensitivity toward unusual events or individuals you may encounter in or around ports, docks, marinas, riversides, beaches or waterfront communities. To report suspicious activities, call the USCG National Response Center at 1-800-424-8802. If there is immediate danger to life or property call 911 or hail the Coast Guard on marine radio channel 16.

## 10.3 Rules of the Road

As in driving an automobile, there are a few rules you must know for safe boating operation. The following information describes the basic navigation rules and action to be taken by vessels in a crossing, meeting or overtaking situation while operating in inland waters.

These are basic examples and not intended to teach all the rules of navigation. For further information contact the Coast Guard, Coast Guard Auxiliary, Department of Natural Resources, or your local boat club. These organizations sponsor courses in boat handling, including rules of the road. We strongly recommend such courses. Books on this subject are also available from your local library.

### Crossing Situations

CAUTION

**Avoid collisions by following navigation rules. If a collision appears unavoidable, both vessels must act. Prudence takes precedence over right-of-way rules if a crash is imminent. Less maneuverable boats generally have the right of way. Steer clear of the right-of-way boat and pass to its stern.**

In the illustration below, the boat on the right has the right of way and should maintain its course and speed. The other vessel should slow down and permit it to pass. Both boats should sound appropriate signals.

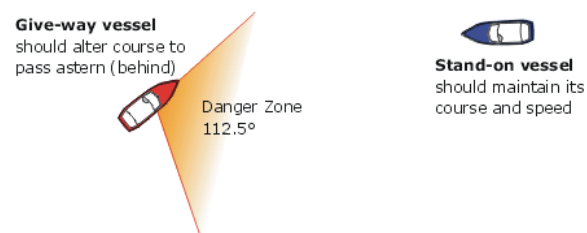

### Overtaking Situations

When one motorboat is overtaking another motorboat, the boat being passed has the right of way. The overtaking boat must make adjustments necessary to provide clearance for a safe passage of the other vessel and should sound appropriate signals.

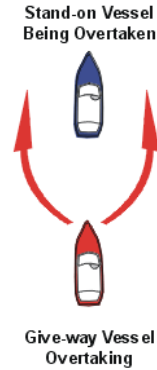

**Meeting in Head-On or Nearly-So Situations**

When two motorboats are approaching each other head-on or nearly head-on, neither boat has the right of way. Both boats should reduce their speed and turn to the right, passing port side to port side, providing enough clearance for safe passage. Both boats should sound appropriate signals.

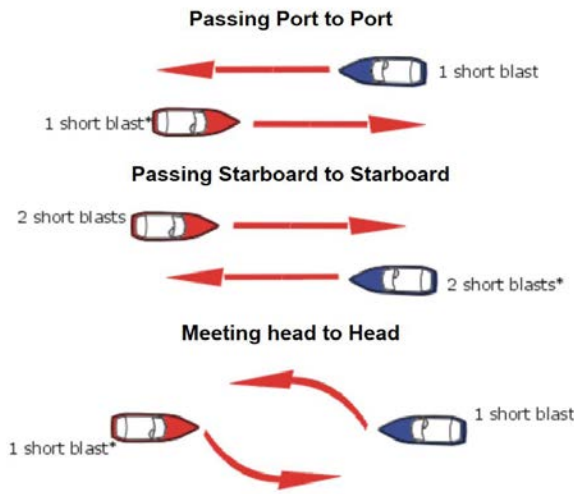

\*Response not sounded on International Waters

**The General Prudential Rule**

In obeying the Rules of the Road, due regard must be given to all dangers of navigation and collision and to any special circumstances, including the limitations of the vessels, which may justify a departure from the rules in order to avoid immediate danger or a collision.

**Navigation Aids**

Aids to navigation are placed along coasts and navigable waters as guides to mark safe water and to assist mariners in determining their position in relation to land and hidden dangers. Each aid to navigation is used to provide specific information. Become familiar with these and any other markers used in your boating area.

**Port Side Lateral System**  
As seen entering from seaward  
(Green Light Only  
Odd Numbered Aids)

**Starboard Lateral System**  
As seen entering from seaward  
(Red Light Only  
Even Numbered Aids)

	<b>Green Light</b> Chart Symbol "1" Fl G 6s		<b>Red Light</b> Chart Symbol "2" Fl R 6s
	<b>Green Lighted Buoy</b> Chart Symbol G "9" Fl G 4s		<b>Red Lighted Buoy</b> Chart Symbol R "8" Fl R 4s
	<b>Can</b> Chart Symbol G C "7"		<b>Nun</b> Chart Symbol R N "6"
	<b>Daymark</b> Chart Symbol G "1"		<b>Daymark</b> Chart Symbol R "2"

**CAUTION**

**Storms and waves can move buoys, do not rely on buoys alone to determine your position.**

**10.4 Operating your Boat**

Familiarize yourself with the procedures outlined in the Pre-Cruise Checklist near the beginning of this manual. Be seated and ready with the controls (steering/throttle) when the engine is started or running.

**After starting the engines:**

- Check engine gauges. Make sure all are reading normally.
- Visibly check engines to be sure there are no apparent water, fuel, or oil leaks.

- Check operation of engine cooling systems.
- Check controls and steering for smooth and proper operation.
- Allow engines to warm up for 10 to 15 minutes before operating them above idle speeds.
- Make sure all lines, cables, anchors, etc. for securing the boat are onboard and in good condition. All lines should be coiled, secured, and off the decks when underway.

**REMEMBER:**

When operating a boat, you accept the responsibility for the boat and the safety of passengers and others out enjoying the water.

- Alcohol and any mind-altering chemicals can severely reduce your reaction time and affect your better judgment.
- Alcohol reduces the ability to react.
- Alcohol makes it difficult to judge speed and distance or track moving objects.
- Alcohol reduces night vision and the ability to distinguish red from green.

**STAY ALERT.** The use of alcohol or any other mind-altering chemicals that impair judgment pose a serious threat to you and others. The boat operator is responsible for their consequences and the behavior of passengers.

 <b>WARNING</b>
<p><b>IMPAIRED OPERATION HAZARD</b>  <b>Operating any boat while intoxicated or under the influence of other drugs can cause death or serious injury. DO NOT operate any boat under the influence of any mind-altering chemical.</b></p>

Avoid sea conditions that are beyond the skill and experience of you and your crew.

Make sure at least one other person onboard is instructed in the operation of the boat and it is operated in compliance with all state and local laws.

**DO NOT** operate the boat unless it is completely assembled. Make sure all fasteners are tight and adjustments are to specifications.

Before operating the boat for the first time, read the engine break-in procedures. Refer to the engine owner’s manual and have your dealer describe the operating procedures for your boat. For more information, refer to the engine owner’s manuals.

If the drive unit hits an underwater object, stop the engine. Inspect drive unit for damage. If damaged contact your dealer for a complete inspection and repair of the unit.

For more instructions on safety, equipment and boat handling, enroll in one of the several free boating courses offered. For information on the courses offered in your area, visit the US Coast Guard Auxiliary website, [cgaux.org](http://cgaux.org), and download the Boating Safety Mobile App from the US Coast Guard, [www.uscgboating.org](http://www.uscgboating.org).

**After stopping the boat:**

- Allow engines to drop to idle speed.
- Shift controls to NEUTRAL.

 <b>CAUTION</b>
<p><b>Turn off engines at idle speed. Racing the engine before switching it off can draw water into the engine through the exhaust, resulting in internal damage.</b></p>

If the engines have been running at high speed for a long period of time, allow them to cool by running at idle for 3 to 5 minutes.

- Turn the ignition OFF.
- Raise the trim tabs to full UP position.

## After operation:

- If operated in saltwater, wash the boat and all equipment with soap and water. Flush the engines using fresh water. Refer to the engine owner's manual for instructions on flushing.
- Check the bilge area for debris and excess water.
- Fill the fuel tanks to near full to reduce condensation. Allow room in the tanks for the fuel to expand without being forced out the vent.
- Turn off all electrical equipment except the automatic bilge pumps.
- If you are going to leave the boat unattended for a long period of time, put the battery main switches to OFF and close all seacocks.
- Make sure the boat is securely moored.

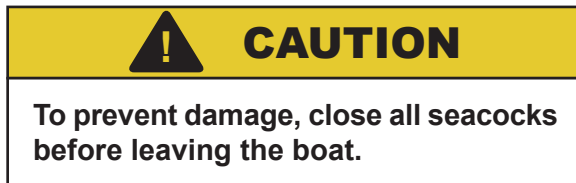

## 10.5 Docking, Anchoring, and Mooring

### Docking and Docklines

Maneuvering a boat near a dock and securing it requires skill and techniques that are unique to water and wind conditions and the dock layout. If possible, position a crew member at the bow and stern to assist with the lines and docking. While maneuvering close to the dock, compensate for wind and current, and anticipate how you can use them to help docking. Practice in open water using an imaginary dock to develop a sense for how the boat handles in different scenarios. You must be able to understand docking techniques before problems occur.

Approaching a dock or backing into a slip in high winds or strong currents requires skill. If you are new to handling a boat, take les-

sons from an experienced pilot and learn to maneuver in tight quarters in less-than-ideal conditions. Also, practice away from the dock during windy conditions.

Dock lines are generally twisted or braided nylon. Nylon is strong and stretches to absorb shock. Nylon also has a long life and is soft and easy on the hands. The size of the line will vary with the size of the boat. Typically a 30-to-40 foot boat will use 5/8-inch line and a 20-to-30 foot boat will use 1/2-inch line. The number of lines and their configuration will vary depending on the dock, the range of the tide, and other factors. Usually a combination of bow, stern and spring lines is used to secure the boat.

### Maneuvering to the Dock

Approach the dock slowly at a 30-to-40 degree angle. When possible, approach against the wind or current. Turn the engines straight and shift to neutral when you feel you have enough momentum to reach the dock. Use reverse to slow the boat and pull the stern toward the dock as the boat approaches. If you approached properly, the boat will lightly touch the pilings at the same time forward momentum is stopped. Have the dock lines ready and secure the boat as soon as it stops. Use fenders to protect the boat while it is docked. Keep the engines running until the lines are secured.

If your boat is equipped with joystick docking, consult your engine package owner's manual for additional instructions.

### Backing into a Slip

Approach the slip with the stern against the wind or current and the engines straight ahead. Use the engines and turn the steering wheel to maneuver the boat into alignment with the slip. Reverse the engines and slowly back into the slip. Shift from reverse to neutral frequently at idle to prevent the boat from gaining too much speed. Move the stern right and left by shifting the engines in and out of

gear or turning the wheel. When nearly in the slip all the way, straighten the engines and shift to forward to stop. Keep the engines running until the lines are secured.

### Securing Docklines

Securing a boat alongside the dock typically requires a bow and stern line and two spring lines. The bow and stern lines are usually secured to the dock at a 40 degree angle aft of the stern cleat and forward of the bow cleat. The after bow spring line is secured to the dock at a 40 degree angle aft of the after bow spring cleat. The forward quarter spring is secured to the dock at a 40 degree angle forward of the stern cleat. The spring lines keep the boat square to the dock and reduce fore and aft movement while allowing the boat to move up and down with the tide.

Securing a boat in a slip is somewhat different. It typically requires two bow lines secured to pilings on each side of the bow, two stern lines secured to the dock and two spring lines that prevent the boat from hitting the dock. The bow lines are typically secured with enough slack to allow the boat to ride the tide. The stern lines are crossed. One line runs from the port aft boat cleat to the starboard dock cleat and the other line runs from the starboard aft boat cleat to the port cleat on the dock. The stern lines center the boat, control the forward motion and allow the boat to ride the tide. Two forward quarter spring lines typically are secured to the stern cleats and to mid ship pilings or cleats. The spring lines keep the boat from backing into the dock while allowing it to ride the tide.

### Leaving the Dock

Start the engines and let them warm up for 10 to 15 minutes before releasing the lines. Boats steer from the stern and it is important you achieve enough clearance at the stern to maneuver the boat as quickly as possible. Push the stern off and maneuver to gain stern clearance quickly. Proceed slowly until the boat has cleared the dock and other boats.

### Mooring

Approach the mooring buoy heading into the wind or current. Shift to neutral when you have just enough headway to reach the buoy. Position a crew member on the bow to retrieve the buoy with a boat hook and secure the line. Keep the engines running until the line is secure.

### Leaving a Mooring

Start the engines and let them warm up before releasing the mooring line. The boat will already be headed into the wind, so move it forward enough to loosen the line and untie it. Back the boat away until you can see the buoy and slowly move away.

### Anchoring

Make sure the bitter end of the anchor rode is attached to the boat before dropping the anchor. Bring the bow into the wind or current and put the engine in neutral. When the boat comes to a stop, lower the anchor over the bow using the windlass. See section 7, Exterior Equipment. Allow enough rode so that it is at least 5 to 7 times the depth of the water and secure the line to a cleat. Use caution to avoid getting your feet or hands tangled in the line. Additional scope of 10 times the depth may be required for storm conditions. Check landmarks on shore to make sure the anchor is not dragging. If it is dragging, start over. It is prudent to use two anchors if you are anchoring overnight or in rough weather.



## WARNING

**SINKING OR DROWNING HAZARD**  
Anchoring at the stern can pull a boat under water. **DO NOT** anchor at the stern.

### Releasing the Anchor

Release the anchor by traversing to the point where the anchor line becomes vertical. It

should release when you pass that point. If the anchor does not release, stop the boat directly above the anchor and tie the line to a cleat as tight as possible. The up and down movement of the boat will usually loosen the anchor. Make sure the anchor is secured and stowed before getting underway.

**10.6 Controls, Steering, or Propulsion System Failure**

The engine covers are machinery guards and must be in place whenever the engines are running. DO NOT operate the boat without the covers in place unless you are performing a check or maintenance.

If the propulsion, control, or steering system fails while you are operating the boat, bring both throttles to idle and shift to neutral. Determine if the boat should be anchored to prevent the boat from drifting or to hold the bow into the seas. Investigate and correct the problem if possible. Make sure the engines are off before investigating the problem. If you are unable to correct the problem, call for help.

**WARNING**

**MOVING PARTS HAZARD**

**Contact with moving parts can entangle, cut, and cause death or serious injury. DO NOT come close enough to make contact with any running machinery moving parts, i.e., engine or propeller. Contact can result in loss of body parts, strangulation, burns and/or severe loss of blood resulting in serious injury or death.**

In case of engine failure, you can operate the boat on one engine. Do not to apply too much power to the running engine. When running one engine to power a twin- or triple-engine boat, the engine will be ‘over propped’ and can be overloaded if too much throttle is applied. Contact your dealer or the engine

manufacturer for the maximum power settings when running on one engine.

**10.7 Collision**

If your boat is involved in a collision with another boat, dock, piling or a sandbar, your first priority is to check passengers for injuries and administer first aid if necessary. Once all passengers’ situations are stabilized, thoroughly inspect the boat for damage. Check below decks for leaks and ensure all control systems for proper operation. Plug all leaks or make the necessary repairs to the control systems before proceeding. Operate slowly and carefully, taking all necessary precautions to be safe. Request assistance if necessary. Haul the boat and make a thorough inspection of the hull, lower unit, and control system for damage.

**10.8 Grounding, Towing, and Rendering Assistance**

The law requires the owner or operator of a vessel to render assistance to any individual or vessel in distress, as long as his vessel is not endangered in the process.

If your boat should become disabled, or if another craft that is disabled requires assistance, be careful. The stress applied to a boat during towing can become excessive. Excessive stress can damage the structure and create a safety hazard for all onboard.

Freeing a grounded vessel or towing a disabled boat requires specialized equipment and knowledge. Line failure and structural damage caused by improper towing have resulted in fatal injuries. We recommend that towing be done by those with the right equipment and knowledge, e.g., the U.S. Coast Guard or a commercial towing company.

The mooring cleats or bow/stern eyes on your boat are not designed or intended to be used for towing or lifting. These cleats are designed as mooring cleats for securing the boat to a dock, pier, etc. only. DO NOT use

these fittings for towing, lifting, or attempting to free a grounded vessel.

When towing operations are underway, have everyone on both vessels stay clear of the tow line and surrounding area. DO NOT allow anyone to be in line with the tow rope; a dangerous recoil can occur if the rope should break or pull free.

Running aground can cause serious injury to passengers and damage the boat and its underwater gear. If your boat runs aground, evaluate the damage, then proceed at low speed to the nearest service facility and have an immediate inspection made before further use. A damaged boat can take on water; keep all life-saving devices close while heading to a dock area. If the boat cannot be immediately removed from the water, thoroughly inspect the bilge area for leaks.

### 10.9 Flooding or Capsizing

Boats can become unstable if they become flooded or completely swamped. Always be aware of the position of the boat to the seas and the amount of water in the bilge. Water entering the boat over the transom can usually be corrected by turning the boat into the waves. If the bilge is flooding because of a hole in the hull or the engine bracket, or a defective hose, you may be able to plug it with rags, close the thru-hull valve, or assist the pumps by bailing with buckets. Put a mayday call into the Coast Guard or nearby boats and distribute life jackets as soon as you discover your boat is in trouble.

If the boat becomes swamped and capsizes, you and your passengers should stay with the boat as long as you can. It is much easier for the Coast Guard, aircraft, or other boats to spot a capsized boat than people in the water.

### 10.10 Transporting your Boat

Your boat is large and should only be trailered by professionals with the right equipment and knowledge to transport large boats without

causing damage. Contact your dealer or the Tiara Yachts Customer Relations Department if you are planning to transport your boat and have any questions in regard to the proper equipment and support for the hull.

Damage from trailers can occur if the boat hull is not supported properly. Make sure the trailer bunks and pads are adjusted so they provide enough support for the hull and are not putting excessive pressure on the lifting strakes. Hull damage resulting from improper trailer support is not covered by the Tiara Yachts warranty.

### 10.11 Man Overboard

If someone falls overboard, be prepared to react quickly, especially when you are offshore.

**The following procedures will help you in recovering a person that has fallen overboard:**

1. Immediately stop the boat, sound a 'man overboard' alarm and have all passengers point to the person in the water.
2. Circle around quickly and throw a throwable PFD, cushion, or life jacket to the person and, if possible, throw another to use as a marker.
3. Keep the person on the driver side of the boat to keep them in sight.
4. Approach the person from the downwind side and maneuver the boat so the propellers are well clear of the person in the water.
5. Turn off the engines when the person is alongside, and assist them to the boat using a ring buoy, boat cushion with a line attached, paddle, or boathook.
6. Pull the person to the boat and assist onboard.
7. Check for injuries and administer first aid if necessary. If the injuries are serious, call for help immediately.



Refer to section 9, Safety Information, for more information on first aid and requesting emergency medical assistance.

Read *A Boater's Guide to Federal Regulations for Recreational Boating*, provided with this manual, and visit [www.uscgboating.org](http://www.uscgboating.org) to learn about US federal regulations regarding trash disposal. Note that local laws may vary; it is your responsibility to understand the regulations in effect in your location.

DANGER

**CARBON MONOXIDE POISONING AND/OR ROTATING PARTS HAZARD**

Poisonous CO gases are present at the rear of the boat when an engine is running. A rotating propeller can cut or entangle swimmers. Either of these hazards will cause death or serious injury. **DO NOT** use the swim/boarding platform when the engine is running.

**10.13 Multi-Colored Lighting**

Your vessel may be equipped with multi-colored LED cockpit accent lighting and/or underwater lights. **NOTE:** Caution should be taken when using multi-colored lights at night away from the dock. Red or green lights used at night could be confusing for other boats navigating nearby. On the water, blue lights are reserved exclusively for law enforcement vessels. The use of blue lights at night in open water, combined with boat movement, could cause confusion in a potential emergency situation, and may result in a fine.

**10.12 Trash Disposal**

Under the MARPOL agreement and U.S. federal law, it is illegal for any vessel to discharge plastic or garbage that contains plastics into any waters. It is also illegal to discharge garbage in the navigable waters of the United States including the Great Lakes.

Regional, state, and local restrictions on garbage discharges also may apply. Vessels of 26 feet or longer must display, in a prominent location, a durable placard at least 4 by 9 inches notifying the crew and passengers of the discharge restrictions. Responsible boaters store refuse in bags and dispose of it properly on shore. Make sure your passengers are aware of the local waste laws and the trash management procedure on your boat.

NOTICE

Any person who violates waste disposal requirements is liable for a civil penalty of up to \$25,000, a fine of up to \$50,000, and imprisonment for up to five years for each violation. Regional, state, and local restrictions on garbage discharges also may apply.

Under the MARPOL agreement and U.S. federal law, it is illegal for any vessel to discharge plastic or garbage containing plastics into any waters. Additional restrictions on dumping non-plastic waste are outlined below. *All* discharge of garbage

is prohibited in the Great Lakes or their connecting or tributary waters. Each knowing violation of these requirements may result in a *fine* up to \$500,000, and up to 6 years imprisonment.

3 nautical miles from shore and anywhere in U.S. Lakes, Rivers, Bays, Sounds.

**ILLEGAL TO DUMP Plastic**  
All other trash



3 to 12 nautical miles offshore

**ILLEGAL TO DUMP Plastic**  
Dunnage, lining & packing materials that float. All other trash if not ground to less than one inch.

12 to 25 nautical miles offshore

**ILLEGAL TO DUMP Plastic**  
Dunnage, lining & packing materials that float.

Outside 25 nautical miles offshore

**ILLEGAL TO DUMP Plastic**



State and local regulations may further restrict the disposal of garbage.

**LET'S ALL DO OUR PART TO PROTECT THE OCEANS!**



Routine Maintenance

11.1 General

 **WARNING**

**FIRE/EXPLOSION/ASPHYXIATION HAZARD**

Cleaning agents and paint ingredients can be flammable and/or explosive, or dangerous to inhale. Make sure ventilation is adequate, wear proper personal protection, and dispose of rags properly ashore.

Vapors from flammable solvents can cause fire, explosion, or asphyxiation, resulting in death or serious injury. Keep open flame or spark away from work area. **DO NOT** paint unless in a well-ventilated area.

Before using a cleaning product, refer to the product directions and specifications.

If urethane foam was used in the construction of your boat, be careful with high temperatures or flames in these areas. Urethane foam can ignite. **DO NOT** smoke, weld, or burn. Avoid the use of space heaters and lights in areas where urethane foam is present. If ignited, urethane foam burns rapidly, produces extreme heat, releases hazardous gases, and consumes much oxygen.

11.2 Exterior Hull and Deck

The exterior of your Tiara Yacht is made up of many different materials and finishes. Each material should be maintained by following the recommendations in the appropriate user manual.

After each use:

- Rinse the boat exterior with clean, fresh water.
- Wash all exterior surfaces and hardware with a sponge or soft bristle brush and

a solution of fresh water and mild detergent. Nonskid areas may be scrubbed with a stiff bristle brush.

- Rinse the boat with fresh water.

Apply a premium marine wax to all smooth (gel coat and/or painted) fiberglass surfaces at least once a year. Follow the directions supplied with the wax.

 **NOTICE**

**Do not use abrasive cleaners on smooth fiberglass surfaces. They will dull the surface and allow dirt to penetrate the surface.**

Most of the shiny white surfaces on your Tiara Yacht are gel coated. The deck, hardtop exterior and swim platform are a few examples. Depending on the build of your boat, the hull sides may be gel coated with a painted boot line or entirely painted. If you are unsure about your boat's finishes, contact your Tiara Yachts dealer.

Gel Coat

Time and exposure to sunlight may cause the gel-coated surfaces to fade, dull, or chalk. Regular applications of a premium marine wax will minimize this. If you find a noticeable chalking of the gel coat you may choose to have it buffed to bring back the original luster. We recommend contacting your Tiara Yachts dealer or other marine service facility if your finish needs attention.

 **CAUTION**

**Experience is required to buff your boat. Do not buff your boat unless you have been properly trained and are using an industrial strength buffer with the appropriate pads and polishing materials.**

After buffing, apply a coat of premium marine wax to all smooth surfaces, following the instructions included with the wax. Refer to the gel coat care card that came with your boat.

If the fiberglass or gel-coated surface should need repair, contact your Tiara Yachts dealer or another qualified marine service facility.

### **Axalta Marine Finish (optional)**

Axalta® polyurethane marine finishes provide superior protection against the elements your boat will face throughout its long life. To ensure you maximize the benefits of the finish, use the following guide. If you are unsure about your boat's finishes, contact your Tiara Yachts dealer.

#### **To maintain your painted hull finish:**

- During the first 30 days following the boat's manufacture, when the finish is still fresh, clean the boat with a water rinse only.
- Do not wax for the first 60 days following the boat's manufacture.
- Do not use a pressure washer for the first 60 days following the boat's manufacture. Using high pressure while the paint is still fresh could affect the finish. Also avoid high pressure too close to areas with visible chips or cracks.
- Wash your boat often, especially when exposed to dusty, acidic or alkaline environments.
- When washing your boat, use non-abrasive, neutral pH (non acidic or alkaline) detergent. Do not use solvent-based solutions for washing.
- Do not wash the boat with extremely hot water or while the surface is hot.
- Avoid washing with stiff bristles. Soft cloth and soft brushes are recommended.
- Do not allow spilled gasoline, oil, anti-freeze, hydraulic fluid, or windshield washer fluid to sit on the paint or gel coat; remove immediately by rinsing with

water. With some oils and hydraulic fluids, the allowable exposure time before staining occurs is significantly shortened if the fluid or the painted surface is hot.

- Have any paint chips, nicks, or scratches repaired as soon as they occur to protect against future degradation.
- Should your boat's finish become damaged, have it repaired as soon as possible. Contact your Tiara Yachts dealer or a marine service facility and specify the same polyurethane marine finish as used for the original finish.

### **Bottom Painting**

If your boat has not been ordered with factory-applied bottom paint, and will be kept in the water for three weeks or more at a time, the bottom should be painted with an antifouling paint. Because of variations in water temperature, marine growth and pollution in different regions, your Tiara Yachts dealer and/or a qualified boat yard in your area should be consulted when deciding what bottom paint system to apply to your hull, because pollution and marine growth can damage fiberglass hulls.

If your boat is equipped with a factory-applied first coat of bottom paint, a second coat should be applied over the first, just before launching. Paint has been provided by Tiara for this purpose. Follow the paint manufacturer's recommendations for preparation and application. Applying the second coat right before launching maximizes the paint's anti-fouling properties.

Sanding or sandblasting the hull bottom will damage the fiberglass. When preparing the hull for bottom paint, use only standard antifouling paints and fiberglass wax removers and primers recommended by the antifouling paint manufacturer. Sanding or sandblasting and the use of a coating other than standard antifouling paint or epoxy barrier coatings are not recommended and will void the hull blister warranty.

DO NOT allow antifouling paint to contact the outboard engines. Most antifouling paints contain copper which will cause severe galvanic damage to the motor. Leave a 1/2" (12.7 mm) barrier between the hull bottom paint and outboard engine.

Most bottom paints require maintenance, especially when the boat is in saltwater or not used for extended periods, or after dry storage. If the hull bottom has been painted with antifouling paint, contact your dealer for the recommended maintenance procedures.

### Sacrificial Anodes

Sacrificial zinc anodes are installed on the trim tabs, transom, and outboard engines. The transom anode is connected to the bonding system and protects the underwater hardware that is bonded.

The anodes are less noble than copper-based alloys and aluminum and will deteriorate first, protecting the more noble underwater hardware against galvanic corrosion. Anodes should be checked monthly and changed when they are 75% of their original size. When replacing the anodes, make sure the contact surfaces are clean, shiny metal and free of paint and corrosion. Never paint over the anode or protect it.

Boats stored in saltwater will require anodes to be replaced at least every 6 months to one year. Anodes requiring replacement more frequently may indicate a stray current problem within the boat or at the slip or marina. Anodes that do not need to be replaced after one year may not be providing the proper protection. Loose or low quality anodes could be the problem. Contact your Tiara Yachts dealer for the proper size and type of anodes to be used and the specific installation procedure.

### Fiberglass Gelcoat Surfaces

Normal maintenance requires only washing with mild soap and water. A stiff brush can

be used on the nonskid areas. Kerosene or commercially prepared products will remove oil and tar which could be a problem on trailered boats. DO NOT use harsh abrasive and chemical cleaners because they can damage or dull the gelcoat, reducing its life and making it more susceptible to stains. When the boat is used in saltwater, wash it thoroughly with soap and water after each use.

Sudden changes in temperature can affect gelcoat. When planning on moving your boat from outdoors to a heated location, allow the change of temperature to be gradual. Warm the location slowly after the boat is brought inside to allow the boat to change temperature slowly as the location is warmed. Or, if you are moving your boat from a warmer area to a colder one, wait for the temperature to be closer to the temperature of the warmer area or allow the warmer area and the boat to cool down.

At least once a season, wash and wax all exposed fiberglass surfaces. Use a high quality automotive or boat wax. Follow the procedure recommended by the wax manufacturer. Washing and waxing of your boat will have the same beneficial effects as they have on an automobile finish. The wax will fill minute scratches and pores, which helps prevent soiling and will extend the life of the gelcoat.

After the boat is exposed to the direct sunlight for a period of time, the color in the gelcoat will tend to fade, dull, or chalk from oxidation of the gel. This condition will be more apparent with dark colors, which require more frequent maintenance. A heavier buffing is required to bring the gelcoat back to its original luster. For power cleaning, use a light cleaner. To clean the boat by hand, use a heavier automotive cleaner. Before cleaning the surfaces, read the instructions given with the cleaner. After cleaning the surfaces, apply wax and polish all fiberglass surfaces except the nonskid areas.

If the fiberglass should become damaged and need repair, contact your Tiara Yachts dealer or an authorized repair person.



## WARNING

### SLIPPERY SURFACE HAZARD

**Cleaning surfaces can generate slippery conditions which can result in death or serious injury. Use caution when cleaning with detergents. Rinse thoroughly.**

Be careful when walking on wet gelcoat surfaces.

DO NOT wax nonskid surfaces, which could make them slippery and increase the possibility of injury.

### Stainless Steel Hardware

When using the boat in saltwater, wash hardware with soap and water after each use. When your boat is used in a more highly corrosive environment—such as saltwater, water with a higher sulfur content, or polluted water—stainless steel may develop surface rust stains. This is normal under these conditions.

Clean and protect by using a high quality boat or automotive wax or a commercial metal cleaner and protectant. DO NOT use citrus-based or abrasive materials such as sandpaper, bronze wool, or steel wool on stainless steel, or damage will result.

### Powder Coated (Painted) Aluminum Surfaces

Regular care is necessary to maintain the appearance of the powder coat finish. Build-up of salt and grime can hold moisture and damage powder coatings. This buildup can cause a corrosive condition that can damage the coating, especially in a salt air or coastal environment.

- Wash the finish regularly with warm water containing a pH neutral detergent (i.e. mild dish soap).
- Use a non-abrasive fiber cloth
- Rinse thoroughly after cleaning

### Chrome Hardware

Rinse with fresh water and wipe dry with a towel or chamois after each use. Use a good chrome cleaner and polish on all chrome hardware. Clean and wax chrome prior to extended storage. In saltwater or other harsh environments, clean and wax more often.

### Acrylic Plastic

Acrylic plastic scratches easily. DO NOT use a dry cloth or glass cleaning solutions on acrylic. Use a soft cloth and mild soap and water for routine cleaning. Solvents and products containing ammonia (including glass cleaners such as Windex®) can permanently damage acrylic plastic.

Fine scratches can be removed with a fine automotive clear-coat polishing compound. A coat of automotive or boat wax is beneficial to protect the surface.



## NOTICE

**Acrylic plastic scratches easily. Use a soft cloth and mild soap and water for routine cleaning. DO NOT use a dry cloth, abrasives, or glass cleaning solutions on acrylic. Solvents and products containing ammonia can permanently damage acrylic plastic.**

### DO NOT use the following on acrylic plastic:

- Abrasive cleaners
- Acetone
- Alcohol
- Cleaners containing ammonia
- Glass cleaners
- Solvents

## Engines

Proper engine maintenance is essential to the performance and reliability of your outboard engines. Maintenance schedules and procedures are outlined in your engine owner's manual; follow them exactly.

Flush the system when the boat is out of the water. Flush daily if used in saltwater.

The age of the gasoline in your tank can affect engine performance. Chemical changes occur as the gasoline ages, causing deposits and varnish in the fuel system and reducing the octane rating of the fuel. Degraded fuel can damage the engine and boat fuel tank and lines. If your boat does not require at least one full tank of fresh fuel a month, add a fuel stabilizer to the gasoline to protect the fuel from degradation. Use only a fuel stabilizer recommended by your Tiara Yachts dealer or the engine manufacturer. Operate the boat at least 15 minutes after adding the stabilizer to allow the treated fuel to reach the engine. Your dealer or engine manufacturer can provide additional information on fuel degradation. For more recommendations for your specific area, check with your local Tiara Yachts dealer.

Avoid using fuels with alcohol additives. Gasoline, extended with an alcohol blend, will absorb moisture from the air which can reach such concentrations that "phase separation" can occur, where the water and alcohol mixture becomes heavy enough to settle out of the gasoline to the bottom of the tank. Since the fuel pick-up tube is near the bottom of the tank, phase separation can cause the engine to run poorly or not at all. This condition is more severe with methyl alcohol and will worsen as the alcohol content increases. Water or a jelly like substance in the fuel filters is an indication of possible phase separation from the use of alcohol blended fuels.

Contact your Tiara Yachts dealer or engine manufacturer for additional information regarding fuels and additives.

## Corian Surfaces

Corian® is resistant to heat, but you should always use a hot pad or a trivet with rubber feet to protect it. Avoid exposing Corian to strong chemicals, such as paint removers, oven cleaners, etc. If contact occurs, flush the surface with water immediately. Soapy water or ammonia-based cleaners will remove most dirt and stains from all types of finishes.

DO NOT use the Corian countertop as a cutting board.

Minor damage, scratches, general or chemical stains, scorching or burns and minor impact marks can be repaired on-site with a light abrasive cleanser and a product such as a Scotch-Brite® pad. For heavier damage, light sanding may be necessary. Heavy damage should be repaired by a Corian-licensed professional.

## 11.3 Seats and Upholstery

### Seat Slides and Swivel Bases

#### Perform the following periodically:

- Inspect and tighten mounting screws between seat slides and seat bottom.
- Inspect and tighten the mounting screws attaching the seat bases to the boat.
- Keep a light film of grease on manual seat slides.
- Keep a light film of grease on manual seat-adjusting mechanisms.
- Clean electric seat slides. DO NOT use harsh chemicals or abrasives. Lubrication is not required.

### Vinyl Upholstery

The vinyl upholstery used on the exterior seats and bolsters and the cabin headliner should be cleaned with soap and water periodically. Stains, spills or soiling should be cleaned up immediately to prevent the possibility of permanent staining. When cleaning, rub gently. DO NOT use products containing ammonia, powdered abrasive cleaners, steel

wool, strong solvents, acetone, and lacquer solvents or other harsh chemicals as they can permanently damage or shorten the life of vinyl. Never use steam heat, heat guns, or hair dryers.

Stronger cleaners, detergents, and solvents may be effective in stain removal, but can cause either immediate damage or slow deterioration. Lotions, sun tan oil, waxes, and polishes, etc., contain oils and dyes that can cause stiffening and staining of vinyls. To clean common stains, follow these recommendations:

- Dry soil, dust and dirt: remove with a soft cloth.
- Dried-on dirt: wash with a soft cloth dampened with water.
- Variations in surface gloss: wipe with a water-dampened soft cloth and allow to air dry.
- Stubborn dirt: wash with a soft cloth, dampened with a delicate laundry soap and water. Rinse with clean water.
- Stubborn spots and stains: spray with Fantastik Cleaner® or Tannery Car Care Cleaner® and rub with a soft cloth. Rinse with clean water.
- Liquid spills: wipe with a clean absorbent cloth immediately. Rinse with clean water.
- Food grease and oily stains: spray with Fantastik Cleaner or Tannery Car Care Cleaner, wiping with a soft cloth immediately. Be careful not to extend the area of contamination beyond its original boundary. Rinse with clean water.

#### 11.4 Cabin Interior

Clean the cabin interior just like you would clean a home interior. Use wood cleaner on teak woodwork and a vacuum cleaner on carpeting.

Air and sunlight are very good cleansers. Periodically, place cushions, bedding, etc., on deck, under the sun and in the fresh air to dry and air out. If cushions or equipment

get wet with saltwater, remove and use clean, fresh water to rinse off the salt crystals. Salt retains moisture and will cause damage. Dry thoroughly and reinstall.

If you leave the boat for a long period of time, open all interior cabin and locker doors and hang a commercially available mildew protector in the cabin. Read the label on the mildew protector carefully and follow instructions. Remove the protector from the cabin and allow the cabin to ventilate completely before using the cabin again.

#### 11.5 Bilge

To keep the bilge clean and fresh, use a commercial bilge cleaner regularly. Follow the directions carefully. All exposed pumps and metal components should be sprayed with a protector periodically to reduce the corrosive effects of high humidity.

	WARNING
<p><b>FIRE/EXPLOSION OR ASPHYXIATION HAZARD</b></p> <p><b>Fumes from flammable solvents can cause fire, explosion, or asphyxiation resulting in death or serious injury. DO NOT use flammable solvents to clean the bilge.</b></p>	

#### 11.6 Engines

Check your engine, transmission, and generator fluids every time you use the boat, and daily on long trips (see chapter 5 for more information). If the engines and Volvo® IPS units (if installed) are kept clean, leaks and other problems are easier to spot. Review and follow the oil, coolant, and filter change intervals outlined in your engine and generator user manuals. Have all engine, IPS units, and generator maintenance performed by your Tiara Yachts dealer or other qualified marine service facility.



**11.7 Oil Change System**

An oil change system for the main engines, transmissions, and generator is installed in the engine room. Refer to the oil change system user manual for use and maintenance information.

**Note:** Be certain to clean up any oil spilled in the bilge during oil changing operations. Failure to do so can allow the bilge pumps to transfer oil into the surrounding water. Properly dispose of any oil-contaminated rags per local environmental requirements.

 **CAUTION**

**Always return the oil change system valves to the closed position after using the system. Failure to do so can result in transfer of oil between the engines and/or generator due to crankcase pressures.**

**11.8 Electrical**

The AC and DC electrical systems require routine maintenance. See section 4, Electrical Systems, for more information.

**11.9 Generator**

The engine maintenance required on the generator is similar to an inboard engine. The engine incorporates a pressure-type lubrication system and a fresh-water-cooled engine block which is thermostatically controlled. The most important factors affecting the longevity of the generator are proper ventilation and maintenance of the fuel system, ignition system, cooling system, lubrication system, and AC alternator.

Maintenance schedules and procedures are outlined in the generator owner’s manual; follow them exactly.

 **WARNING**

**The Federal Water Pollution Control Act prohibits the discharge of oil or oily waste into or upon the navigable waters of the United States, or the waters of the Contiguous Zone, or which may affect natural resources belonging to, appertaining to, or under the exclusive management authority of the United States, if such discharge causes a film or discoloration of the surface of the water or causes a sludge or emulsion beneath the surface of the water. Violators are subject to substantial civil penalties and/or criminal sanctions, including fines and imprisonment. Report all discharges to the National Response Center at 1-800-424-8802 or to your local U.S. Coast Guard office by phone or VHF radio, Channel 16.**

 **CAUTION**

**Always use the correct amount and type of oil recommended by the equipment manufacturer. Failure to do so can result in premature equipment failure and loss of equipment warranty.**



**Operator Notes**

Lined area for operator notes, consisting of 25 horizontal lines.

**Seasonal Maintenance**

**12.1 Winterizing**

**Engines**

Refer to the engine owner’s manual for detailed information on preparing the engines for storage.

**Fresh Water System**

The entire fresh water system must be completely drained. Disconnect all hoses, check valves, etc., and blow all the water from the system. Make sure the water heater and fresh water tank are completely drained. Use only very low air pressure when blowing water from the system in order to prevent damage to components. The check valve mechanism built in the fresh water pump will not remove the water from the pump. Remove the outlet hose on the pump, turn it on, and allow it to pump out any remaining water (approximately a cupful).

Before storing your boat, the water system needs to be drained and winterized.

 **WARNING**

**Hot water will cause burns. Do not drain the freshwater system until water in the water heater tank (if installed) is cool.**

 **CAUTION**

**Do not operate the water heater without water in the water heater tank. Failure to do so could damage the water heater.**

**To drain the fresh water system:**

1. Switch OFF the WATER HEATER breaker on the Master AC Panel in the engine room.

2. Open all fresh water faucets (hot and cold). Leave the faucets open.
3. Switch ON the FRESH WATER breaker(s) on the DC distribution panel.
4. Allow the water to run until the tank is empty. The tank is empty when all faucets no longer produce a stream of water.
5. Switch OFF the FRESH WATER breaker(s).
6. Remove the hoses from the input and output sides of the fresh water pump(s), and let the pump(s) and hoses drain into the bilge. The fresh water pump(s) are located in the mechanical space.
7. Switch ON the FRESH WATER breaker(s) for 3-5 seconds to remove the water from the bottom of the pump housing(s). Turn OFF the FRESH WATER breaker(s).
8. If installed, drain all water from the water heater. Refer to section 5, Plumbing Systems, and the water heater user manual for the draining procedure.

**Next, flush the system with potable water antifreeze:**

1. Close all fresh water system faucets.
2. Reconnect the hoses to the water pumps.
3. If an optional ice maker is installed:
  - Disconnect the ice maker water supply and plug the supply line.
  - Switch ON the ICE MAKER breaker on the AC distribution panel, if installed.
  - Allow the unit to run for an hour.
  - Remove any cubes that may have been ejected during this period.
  - Switch OFF the breaker and prop the ice maker door open to let the unit defrost.
  - After the ice maker has defrosted, wipe it dry. **NOTE: At no time should potable water antifreeze be allowed to enter the ice maker. Follow the ice maker user manual for winterization procedure.**

4. Pour five (5) gallons of potable water antifreeze into the water tank via the WATER fill fitting(s) on the gunwale(s).
5. Turn both water heater valves (if installed) fully counter-clockwise to the bypass position.
6. Switch ON the FRESH WATER breaker(s) on the DC distribution panel.
7. Open all faucets in the system (hot and cold), one at a time, until the antifreeze begins to come out, and then close.
8. Switch OFF the FRESH WATER breaker(s).

An alternate method is to use commercially available nontoxic, fresh water system antifreeze. After draining the potable water tank, lines and water heater (if installed), pour the antifreeze mixture into the fresh water tank, then prime and operate the pump until the mixture flows from all fresh water faucets. Be sure to open ALL faucets, including the water supply valve for the head. Make sure antifreeze has flowed through all of the fresh water drains. Allow the antifreeze to fill the sink traps.

The shower/cabin drain sump system must be winterized also. Clean debris from the drain and sump and flush for several minutes with fresh clean water. After the system is clean, pump the drain sump as dry as possible. Then pour a potable water antifreeze mixture into the shower drain until antifreeze has been pumped through the entire system and out of the thru-hull.

For additional information, refer to section 5, Plumbing Systems.

### Raw Water System

Drain the raw water systems completely. Disconnect all hoses and blow the water from the system. Use only very low air pressure when blowing water from the system to prevent damage to components. The check valve mechanism built into the raw water washdown pump will not remove the water

from the pump. Remove the outlet hose on the pump, turn it on, and allow it to pump out any remaining water (approximately a cupful).

An alternate method is to use commercially available nontoxic, potable water system antifreeze. If antifreeze is used, pour the mixture into a pail and put the raw water intake lines into the solution. Turn on the raw water washdown pump using the WASHDOWN PUMP breaker on the Master DC panel in the engine room. Run the pump until the antifreeze solution is visible at all raw water faucets, discharge fittings, and drains. Make sure antifreeze has flowed through all of the raw water drains.

### Generator Raw Water Systems

If a generator is installed on your Tiara Yacht, drain the sea strainer, heat exchangers, and raw water supply and discharge lines for the generator raw water supply pumps. Make sure all sea water has drained from the exhaust system. Some generator engine mufflers have a drain plug that must be removed to properly drain the muffler.

Once the exhaust system has been drained, pour a nontoxic marine engine antifreeze mixture into a large pail and put the generator raw water intake lines into the solution. Run the generator until the antifreeze solution is visible at the exhaust port, then shut the engine off.

Winterize the generator engine and fuel system by following the generator manufacturer's winterizing procedures. Refer to generator's owner's manuals or contact a Tiara dealer.

### Fuel System

Leave the fuel tank nearly full to reduce condensation that can accumulate in the tank. Allow enough room for fuel to expand without leaking from the vents.

Algae can grow in the accumulated water in diesel fuel tanks, especially in warm climates.

Adding a high quality diesel fuel additive containing an algaecide may be required to control algae during storage.

### Marine Toilet

Pump out the head. Flush the holding tank using clean soap, water, deodorizer, and pump-out cleaning solution.

Refer to the toilet owner's manual and winterize the toilet following the procedures exactly. Drain the intake and discharge hoses completely using low air pressure if necessary. The head holding tank and macerator discharge pump must be pumped dry. Pour one gallon of potable water antifreeze into the tank through the deck waste pumpout fitting. After the antifreeze has been added to the holding tank, open the overboard discharge valve and activate the macerator pump until the antifreeze solution is visible at the discharge thru-hull.

### Air Conditioner

Disconnect and drain the air conditioner intake and discharge hoses. Remove all water from the sea strainer and thru-hull fitting. Allow all water to drain from the system. An alternate method is the use of commercially available nontoxic, potable water system antifreeze. If antifreeze is used, drain the sea strainer and pour the mixture into a pail and put the raw water intake line into the solution. Run the air conditioner until the antifreeze solution is visible at the discharge fitting on the hull side.

Air conditioner components must be winterized also; follow winterizing procedure in the air conditioner owner's manual.

### Bilge

The bilge pumps and bilge pump lines must be completely free of water and dried out when the boat is laid up for the winter in climates where freezing occurs. Compartments in the bilge that will not drain completely should be pumped out and then sponged until

completely free of water. Dry the hull bilge and self-bailing cockpit troughs. Water freezing in these areas could cause damage. Coat all metal components, wire busses, connector plugs (in the bilge), strainers, seacocks, and steering components with a protecting oil. Wipe the bilge areas clean and dry.

### Covering for Winter Storage

Proper storage is very important to prevent serious damage to the boat. If the boat is stored outside, support and secure a storage cover properly over the boat. It is best to have a frame built over the boat to support the cover. It should be a few inches wider than the boat so the cover will clear the rails and allow passage of air. If this cover is fastened too tightly there will be inadequate ventilation, which can lead to mildew, moisture accumulation, etc. Fasten the cover down securely so wind cannot remove it or cause chafing of the hull superstructure. DO NOT store the boat in a damp storage enclosure. Excessive dampness can cause electrical problems, corrosion, and excessive mildew.

DO NOT use the bimini top or convertible top cover in place of the winter storage cover. The life of these tops can be shortened if exposed to harsh weather elements for long periods.

DO NOT use an electric or fuel burning heating unit in the bilge area.

If the boat is to be stored indoors, make sure the building has enough ventilation and there is enough ventilation both inside the boat and around the boat. If the boat is to be stored indoors or outdoors, open all drawers, clothes lockers, cabinets, and interior doors a little. If possible, remove the upholstery, mattresses, clothing, and rugs.

## 12.2 Storage and Lay-up

It is essential that care be used when lifting your boat. Make sure the spreader bar at each sling is at least as long as the distance

across the widest point of the boat that the sling will surround. The sling positions are marked with small labels on each side of the boat under the rubrails. Tie fore and aft slings together to prevent slings from sliding on the hull.

Elevating lifts are commonly used to store boats for extended periods. To provide proper support, the bunks that support the hull should be aligned with and run parallel to the hull stringers. The bow and stern eyes, if equipped, should not be used as sole support for storage.

Your boat can be damaged from improper lifting and rough handling when being transported by lift trucks. Care and proper handling procedures must be used when using a lift truck to move your boat. DO NOT attempt to lift the boat with a substantial amount of water in the bilge.



**CAUTION**

**Failure to follow the proper lifting procedures while lifting your boat may result in structural damage to the hull and deck or underwater gear.**

Severe gelcoat cracking or more serious hull damage can occur during hauling and launching if pressure is created on the gunwales (sheer) by the slings. Use flat, wide slings and spreaders long enough to keep pressure from the gunwales. DO NOT allow your boat to be hauled when the spreaders on the lift are not wide enough to take the pressure off the gunwales.

#### To prepare the boat for storage:

- Remove the bilge drain plug(s), if installed.
- Thoroughly wash the fiberglass exterior, especially the antifouling portion of the bottom. Remove as much marine growth as possible. Lightly wax the exterior fiberglass components.

- Remove all oxidation from the exterior hardware and apply a light film of moisture-displacing lubricant.
- Remove propellers and grease the propeller shafts using light waterproof grease.
- Remove batteries and clean using clear, clean water. Make sure batteries have sufficient water and terminals are clean. Keep the batteries charged and stored in a cool, dry place and safe from freezing. See section 4, Electrical Systems, and the battery owner's manual for more information.
- Follow the AC and DC electrical systems maintenance instructions in section 4, Electrical Systems.
- Coat all faucets and exposed electrical components in the cabin and cockpit with a protecting oil.
- Thoroughly clean the interior of the boat; vacuum all carpets and dry-clean upholstery.
- Remove cushions
- Open the refrigerator/cooler door and as many locker doors as possible. Leaving as many of these areas open as possible will improve fresh air ventilation during the storage period.
- Place a mildew preventive system in the cabin area before it is closed for storage.
- Clean the exterior upholstery with a good vinyl cleaner, and dry thoroughly. Spray the weather covers and boat upholstery with a spray disinfectant. Enclosed areas such as the refrigerator, shower basin, storage locker areas, etc., should also be sprayed with a disinfectant.

#### Supporting the Boat for Storage

A trailer, elevating lift, or well-made cradle is the best support for your boat during storage. When storing the boat on a trailer for a long period:

- Make sure the rollers and pads support the hull of the boat and the trailer is on a level surface with the bow high enough so water will drain from the bilge and

cockpit. The trailer must properly support the hull. The bunks and rollers should match the bottom of the hull and should not put pressure on the lifting strakes.

- Make sure the hitch is properly supported.
- Check the tires once each season. Add enough air for the correct amount of inflation for the tires.
- Make sure the engines are in the down position.

Custom-made cradles, with protective padding on the bunks, are available through your Tiara Yachts dealer.

### When storing the boat on a lift or cradle:

- The cradle must be specific for boat storage. Make sure the lift or cradle is well-supported with the bow high enough to provide proper drainage of the bilge. The cradle or lift must be in the proper fore and aft position to properly support the hull. When the cradle or lift is in the correct location, the bunks should match the bottom of the hull and should not be putting pressure on the lifting strakes.
- Make sure the engines are in the down position.
- Make sure bunks and rollers are adjusted so they are not putting pressure on the lifting strakes and are providing enough support for the hull. Hull damage resulting from improper cradle or trailer support is not covered by the Tiara warranty.

## 12.3 Recommissioning

DO NOT operate the boat unless it is completely assembled. Keep all fasteners tight. Keep adjustments according to specifications.

Before launching the boat, make sure to install hull drain plug(s).

### Recommissioning the boat after storage:

- Charge and install the batteries.
- Install hull drain plug(s).
- Check the bilge area and all thru-hulls and seacocks to ensure there are no leaks.
- Open all seacocks and make sure the hoses and fittings are not leaking.
- Verify all bilge pumps are operational by manually activating the float switch at each pump.
- Check the engines and generator for damage and follow the manufacturer's instructions for recommissioning.
- Check the mounting bolts of engines to make sure they are tight.
- Perform all routine maintenance.
- Check all hose clamps for tightness.
- Pump antifreeze from any systems winterized with antifreeze and flush several times with fresh water. Make sure all antifreeze is flushed from the water heater (if installed) and it is filled with fresh water before it is activated. Disinfect the fresh water system. Refer to section 5, Plumbing Systems, for instructions.
- Check and lubricate the steering system.
- Clean and wash the boat.
- Install all upholstery, cushions, and canvas.

### After launching:

- Check all water systems and the engine mounting bolts for leaks. Operate each system one at a time and check for leaks and proper operation.
- Make sure all BILGE pump switches are ON.
- When the engines start, check the cooling system port below the engine cowling for a strong stream of water to ensure cooling pump is operating.
- Carefully monitor the gauges and check for leakage and abnormal noises.
- Operate the boat at slow speeds until the engine temperature stabilizes and all systems are operating normally.





**Aft:** In, near, or toward the stern of a boat.

**Aground:** A boat stuck on the bottom.

**Amidships:** In or toward the part of a boat midway between the bow and stern.

**Anchor:** A specially shaped heavy metal device designed to dig efficiently into the bottom under a body of water and hold a boat in place.

**Anchor locker:** a locker, usually located in the bow of a boat, used for stowing the anchor line or chain

**Anchorage:** An area specifically designated by governmental authorities in which boats may anchor.

**Ashore:** On shore.

**Astern:** Behind the boat, to move backwards.

**Athwartship:** At right angles to the center line of the boat.

**Barnacles:** Small, hard-shelled marine animals which are found in salt water attached to pilings, docks and bottoms of boats.

**Beam:** The breadth of a boat usually measured at its widest part.

**Beamy:** boats of greater than normal beam

**Bearing:** The direction of an object from the boat, either relative to the boat's direction or to compass degrees.

**Berth:** A bunk or a bed on a boat.

**Bilge:** The bottom of the boat below the flooring.

**Bilge Pump:** A pump that removes water that collects in the bilge.

**Boarding:** Entering or climbing into a boat.

**Boarding Ladder:** Set of steps temporarily fitted over the side of a boat to assist persons coming aboard.

**Boat Hook:** Short shaft of wood or metal with a hook fitting at one end shaped to aid in extending one's reach from the side of the boat.

**Bow:** The front end of a boat's hull.

**Bow Line:** A line that leads forward from the bow of the boat.

**Bow Rail:** Knee high rails of solid tubing to aid in preventing people from falling overboard.

**Bridge:** The area from which a boat is steered and controlled.

**Bridge Deck:** A deck forward and usually above the cockpit deck.

**Broach:** When the boat is sideways to the seas and in danger of capsizing; a very dangerous situation that should be avoided.

**Bulkhead:** Vertical partition or wall separating compartments of a boat.

**Cabin:** Enclosed superstructure above the main deck level.

**Capsize:** When a boat lays on its side or turns over.

**Chapman's:** Chapman Piloting & Seamanship, by Chapman and Jonathon Eaton; published by Hearst.

**Chain locker:** See anchor locker.

**Chock:** A deck fitting, usually of metal, with inward curving arms through which mooring or anchor lines are passed so as to lead them in the proper direction both onboard and off the boat.

**Cleat:** A deck fitting, usually of metal with projecting arms used for securing anchor and mooring lines.

**Closed Cooling System:** A separate supply of fresh water that is used to cool the engine and circulates only within the engine.

**Coaming:** A vertical piece around the edges of cockpit, hatches, etc., to stop water on deck from running below.

**Cockpit:** An open space, usually in the aft deck, outside of the cabin.

**Companionway:** Opening in the deck of a boat to provide access below.

**Compartment:** The interior of a boat divided off by bulkheads.

**Cradle:** A framework designed to support a boat as she is hauled out or stored.

**Cutlass Bearing:** A rubber bearing in the strut that supports the propeller shaft.

**Deck:** The floor-like platform of a boat that covers the hull.

**Displacement:** The volume of water displaced by the hull. The displacement weight is the weight of this volume of water.

**Draft:** The depth of water a boat needs to float.

**Drydock:** A dock that can be pumped dry during boat construction or repair.

**Dry Rot:** A fungus attack on wood areas.

**Electrical Ground:** A connection between an electrical connector and the earth.

**Engine Beds:** Sturdy structural members running fore and aft on which the inboard engines are mounted.

**EPIRB:** Emergency Position Indicating Radio Beacon. Operates as a part of a worldwide satellite distress system.

**Even Keel:** When a boat floats properly as designed.

**Fathom:** A measure of depth. One Fathom = 6 feet.

**Fender:** A soft object of rubber or plastic used to protect the topsides from scarring and rubbing against a dock or another vessel.

**Fend off:** To push or hold the boat off from the dock or another boat.

**Flying Bridge:** A control station above the level of the deck or cabin.

**Flukes:** The broad portions of an anchor which dig into the ground.

**Following Sea:** A sea that comes up from the stern and runs in the same direction that the boat is going.

**Fore:** Applies to the forward portions of a boat near the bow.

**Foundering:** When a boat fills with water and sinks.

**Fuel pump:** feeds fuel under pressure

**Freeboard:** The height from the waterline to the lowest part of the deck.

**Galley:** The kitchen of a boat.

**Grab Rail:** Hand-hold fittings mounted on cabin tops or sides for personal safety when moving around the boat, both on deck and below.

**Ground Tackle:** A general term including anchors, lines, and other gear used in anchoring.

**Grounds:** A boat touches the bottom.

**Gunwale:** The upper edge of a boat's side.

**Hand Rail:** Rail mounted on the boat, for grabbing with your hand, to steady you while walking about the boat.

**Harbor:** An anchorage which provides reasonably good protection for a boat, with shelter from wind and sea.

**Hatch:** An opening in the deck with a door or lid to allow for access down into a compartment of a boat.

**Head:** A toilet on a boat.

**Heat Exchanger:** Used to transfer the heat that is picked up by the closed cooling system to the raw cooling water.

**Helm:** The steering and control area of a boat.

**Hull:** The part of the boat from the deck down.

**Inboard:** A boat with the engine mounted within the hull of the boat. Also refers to the center of the boat away from the sides.

**Inboard/outboard:** Also stern drive or I/O. A boat with an inboard engine attached to an outboard drive unit.

**Keel:** A plate or timber plate running lengthwise along the center of the bottom of a boat.

**Knot:** Unit of speed indicating nautical miles per hour. 1 knot = 1 nautical mile per hour (1.15 miles per hour). A nautical mile is equal to one minute of latitude: 6076 feet. Knots times 1.15 equals miles per hour. Miles per hour times .87 equals knots.

**Lay-up:** To decommission a boat for the winter (usually in northern climates).

**Leeward:** The direction toward which the wind is blowing.

**Length On The Waterline (LWL):** A length measurement of a boat at the waterline from the stern to where the hull breaks the water near the bow.

**Length Overall (LOA):** a length measurement of a boat from the fore part of the stem to the after part of the stern

**Life Preserver:** provides additional buoyancy to keep a person afloat when he/she is in the water

**Limber Hole:** A passage cut into the lower edges of floors and frames next to the keel to allow bilge water to flow to the lowest point of the hull where it can be pumped overboard.

**Line:** The term used to describe a rope when it is on a boat.

**Lists:** A boat that inclines to port or starboard while afloat.

**Locker:** A closet, chest or box aboard a boat.

**Loran:** An electronic navigational instrument which monitors the boat's position using signals emitted from pairs of transmitting stations.

**Lunch hook:** A small light weight anchor typically used instead of the working anchor. Normally used in calm waters with the boat attended.

**Marina:** A protected facility primarily for recreational small craft.

**Marine Ways or Railways:** Inclined planes at the water's edge onto which boats are hauled.

**Midships:** The center of the boat.

**Moored:** A boat secured with cables, lines or anchors.

**Mooring:** An anchor permanently embedded in the bottom of a harbor that is used to secure a boat.

**Nautical Mile:** A unit of measure equal to one minute of latitude. (6076 feet)

**Nun Buoy:** A red or red-striped buoy of conical shape.

**Oil Pump:** Supplies lubricating oil where needed within the engine.

**Outboard:** A boat designed for an engine to be mounted on the transom. Also a term that refers to objects away from the center line or beyond the hull sides of a boat.

**Overhead:** the ceiling of a cabin or compartment,

**Pad Eye:** A deck fitting consisting of a metal eye permanently secured to the boat.

**Personal Flotation Device (PFD):** For example, a life preserver or throwable device.

**Pier:** A structure which projects out from the shoreline.

**Pile or Piling:** A long column driven into the bottom to which a boat can be tied.

**Pitch:** The measure of the angle of a propeller blade. Refers to the theoretical distance the boat travels with each revolution of the propeller.

**Pitching:** The fore and aft rocking motion of a boat as the bow rises and falls.

**Plenum:** a chamber for directing air flow, as in engine intake air plenum

**Port:** The left side of the boat when facing the bow.

**Porthole (port):** The opening in the side of a boat to allow the admittance of light and air.

**Propeller:** A device having two or more blades that is attached to the engine and used for propelling a boat.

**Propeller Shaft:** Shaft which runs from the back of the engine gear box, aft, through the stuffing box, shaft log, struts, and onto which the propeller is attached.

**Pyrotechnic Distress Signals:** Distress signals that resemble the brilliant display of flares or fireworks.

**Raw Water Cooled:** Refers to an engine cooling system that draws sea water in through a hull fitting or engine drive unit, circulates the water in the engine, and then discharges it overboard.

**Reduction Gear:** Often combined with the reverse gear so that the propeller turns at a slower rate than the engine.

**Reverse Gear:** Changes the direction of rotation of the propeller to provide thrust in the opposite direction for stopping the boat or giving it sternway.

**Roll:** A boat's sideways rotational motion in rough water.

**Rope Locker:** See anchor locker.

**Rubrail:** Railing (often rubber or hard plastic) that runs along the boat's sheer to protect the hull when coming alongside docks, piers, or other boats.

**Rudder:** A movable flat surface that is attached vertically at or near the stern for steering.

**Sea anchor:** An anchor that does not touch the bottom. Provides drag to hold the bow in the most favorable position in heavy seas.

**Scupper:** An opening in the hull side or transom of the boat through which water on deck or in the cockpit is drained overboard.

**Seacock:** Safety valves installed just inside the thru-hull fittings and ahead of the piping or hose running from the fittings.

**Shaft Log:** Pipe through which the propeller shaft passes.

**Sheer:** The uppermost edge of the hull.

**Sling:** A strap which will hold the boat securely while being lifted, lowered, or carried.

**Slip:** A boat's berth between two pilings or piers.

**Sole:** The deck of a cockpit or interior cabin.

**Spring Line:** A line that leads from the bow aft or from the stern forward to prevent the boat from moving ahead or astern.

**Starboard:** The right side of a boat when facing the bow.

**Steerageway:** Sufficient speed to keep the boat responding to the rudder or drive unit.

**Stem:** The vertical portion of the hull at the bow.

**Stern:** The rear end of a boat.

**Stern line:** a line that leads aft from the stern of the boat

**Stow:** To pack away neatly.

**Stringer:** Longitudinal members fastened inside the hull for additional structural strength.

**Strut:** Mounted to the hull which supports the propeller shaft in place.

**Strut Bearing:** See "cutlass bearing."

**Stuffing Box:** Prevents water from entering at the point where the propeller shaft passes through the shaft log.

**Superstructure:** Something built above the main deck level.

**Swamps:** When a boat fills with water from over the side.

**Swimming Ladder:** Much the same as the boarding ladder except that it extends down into the water.

**Taffrail:** Rail around the rear of the cockpit.

**Thru-hull:** A fitting used to pass fluids (usually water) through the hull surface, either above or below the waterline.

**Topsides:** The side skin of a boat between the waterline or chine and deck.

**Transom:** A flat stern at right angles to the keel.

**Travel Lift:** A machine used at boat yards to hoist boats out of and back into the water.

**Trim:** Refers to the boat's angle or the way it is balanced.

**Trough:** The area of water between the crests of waves and parallel to them.

**Twin-Screw Craft:** A boat with two propellers on two separate shafts.

**Underway:** When a boat moves through the water.

**Wake:** Disrupted water that a boat leaves astern as a result of its motion.

**Wash:** The flow of water that results from the action of the propeller or propellers.

**Waterline:** The plane of a boat where the surface of the water touches the hull when it is afloat on even keel.

**Water pump:** circulates cooling water

**Watertight Bulkhead:** Bulkheads secured so tightly so as not to let water pass.

**Wharf:** A structure generally parallel to the shore.

**Windlass:** A winch used to raise and lower the anchor.

**Windward:** Toward the direction from which the wind is coming.

**Working Anchor:** An anchor carried on a boat for most normal uses. Refers to the anchor used in typical anchoring situations.

**Yacht Basin:** A protected facility primarily for recreational small craft.

**Yaw:** Side-to-side movement, usually caused by rough seas.

---

Operator Notes

---

---

---

---

---

---

---

---

---

---

---

---

---

---

---

---

---

---

---

---

---

---

---

---

---

---

---

---

---

---

## Owner's Guide: Care & Upkeep of Fiberglass Products

As the world's premier gel coat supplier, Polynt Composites has provided this brochure as a guide to properly maintain and care for your gel coat surface.

Gel Coats provide a protective layer against weathering on a surface. Over time, exposure to sunlight, water, dust and chemicals cause wear and tear on the gel coat surface. This results in chalking, discoloration, yellowing or loss of gloss. By following simple, regular maintenance procedures, you can minimize these effects.

### Basic Maintenance

When not in use, keep the gel coat surface out of the sun or covered with a canvas tarp. Do not use plastic sheeting or other non-porous materials as they trap moisture between the cover and the surface, causing damage to the gel coat.

For best results, use a cleaner recommended for use with fiberglass and follow label instructions. Alternatively, you can wash the surface with a mild detergent, such as dishwashing soap.

DO NOT use automatic dishwasher detergent, abrasive cleaners, bleach, strong acids or bases (i.e. TSP or ammonia). Only use pH neutral cleaners.

Wax at least twice a year to restore gloss and protect the finish. Only use a wax that is recommended for gel coat surfaces and follow instructions carefully. NEVER wax a gel coat surface in direct sunlight.

### Corrective Procedures\*

#### Chalking

A fine rubbing compound as well as a mild detergent will reduce the weathering and chalking accumulated on the surface. Use only a fine grit compound and follow label directions carefully. DO NOT apply rubbing compound in direct sunlight. For best results, wax after applying compound. When applying wax, remove excess compound and apply a thin layer of wax using a clean cloth. It is recommended to use a wax designed for fiberglass.

#### Scratches, Nicks and Stains

Most scratches and nicks can be removed by using a rubbing compound followed by waxing as described above. Deep marks or gouges should be professionally repaired.

Most stains can be removed by washing with mild detergent. For stubborn stains, use a fine abrasive household cleanser designed for fiberglass products, followed by waxing to restore its original luster.

Non-water soluble stains such as grease and oil, rubber heel marks, etc., can be removed by using a solvent such as acetone, rubbing alcohol, toluene or xylene, followed by a mild detergent. If these solvents are not effective, try a rubbing compound or fine sanding followed by a rubbing compound and then waxing.

If you have questions, consult your local dealer.



**Polynt Composites USA**  
99 E. Cottage Ave  
Carpentersville, IL 60110

800-322-8103

*\*Always try a test spot first*





Maintenance	Each Use	Weekly	Monthly	Semi Annually	Yearly	As Needed
Clean hull below the waterline				X		
Bottom paint					X	X
Check sacrificial anodes			X			
Replace sacrificial anodes					X	
Wash boat canvas & hardware	X		X			
Wax exterior gelcoat				X		X
Clean & protect hardware						X
Polish & protect plastic glass					X	X
Clean exterior upholstery	X					X
Clean cabin & interior upholstery						X
Flush engine with fresh water	X					
Spray metal components in bilge with a protector			X			
Clean bilge				X		X
Check bilge for leaks	X		X			
Inspect & operate thru-hull valves			X			
Inspect steering & control systems	X					
Service steering & control systems				X		
Inspect fuel system for leaks	X					
Inspect & service fuel system				X		
Inspect fuel tank vents & screens					X	
Replace fuel filters					X	
Lubricate fuel fill o-rings			X			
Inspect fire extinguisher			X			
Test bilge pump auto switches	X					
Inspect & protect electrical components, wire & battery connections				X		
Check battery electrolyte & service			X			
Test and inspect AC electrical system & shore power cord				X		
Inspect water systems for leaks				X		
Check neutral safety switch	X					
Check trim tab fluid level			X			







DEPARTMENT OF HOMELAND SECURITY U.S. Coast Guard <b>RECREATIONAL BOATING ACCIDENT REPORT</b>		OMB Control Number: 1625-0003 Expires: 07/31/2022
<b>INSTRUCTIONS:</b> Use "Report required because" section below to determine if a report is required for your accident. If required, please have each vessel owner or operator involved in the accident submit a report to their state reporting authority. Each boat operator/owner involved in an accident should submit a separate report. For each question below, please provide answers if applicable and if known; otherwise leave blank.		
<b>Privacy Act Notice</b>		
<b>Authority:</b> 46 U.S.C. 6102 and 33 CFR 173 & 174 authorize the collection of information on boating accidents. <b>Purpose:</b> The Coast Guard uses this information for statistical purposes, chiefly to inform the public, to measure the Program's efforts, and to regulate issues relating to boating safety. <b>Routine Uses:</b> The Coast Guard shares this information within the agency, and if state and federal law permit it, to the public.		
<b>REPORT SUBMISSION</b>		
<b>Report required because (select all that apply):</b> <input type="checkbox"/> At least one person in this accident <i>died</i> . If so, how many? <input style="width: 50px;" type="text"/> <input type="checkbox"/> At least one injured person in this accident <i>required or was in need of treatment beyond first aid</i> . If so, how many? _____ <input type="checkbox"/> At least one person in this accident <i>disappeared</i> and has not yet been recovered. If so, how many? _____ <input type="checkbox"/> All boat and other property damage (e.g., fishing/hunting gear) caused by this accident <i>totaled (or likely totaled) \$2,000 or more</i> : Approximate value of damage to <i>your</i> boat: \$ _____ Approximate value of damage to <i>your</i> other property: \$ _____ <input type="checkbox"/> Your or another <i>boat</i> in this accident was (or likely was) a <i>total loss</i>		<b>To be submitted within:</b> 48 hours (if injury, disappearance or death) 10 days (if boat/property damage only)  To be submitted to: (Local State Reporting Authority)  Phone: You may submit any comments concerning the accuracy of the burden estimate or any suggestions for reducing the burden to: Commandant (CG-BSX-21), U.S. Coast Guard, Washington, DC 20593-0001 or Office of Management and Budget, Paperwork Reduction Project (1625-0003), Washington, DC 20503. Questions relating to the collection of this data should be sent to the Coast Guard.
<b>Report submitted by (select all that apply):</b> <input type="checkbox"/> Boat Operator (required if possible) <input type="checkbox"/> Boat Owner (if operator unable, or same as operator) <input type="checkbox"/> Other (describe): _____		<b>For State Agency Use Only</b>
First Name	Last Name	Phone
		Primary Cause of Accident
<b>ACCIDENT SUMMARY</b>		
<b>WHEN</b> Date: (mm/dd/yyyy)      Time: am <input type="checkbox"/> pm <input type="checkbox"/> (select one)		<b>ACCIDENT DESCRIPTION:</b> Briefly describe this accident (attach extra pages if necessary)
<b>WHERE</b> Body of Water Name		
Location (on water) description		<b>DAMAGE TO YOUR BOAT:</b> Briefly summarize any damage to your boat
Nearest city/town		
County:	State:	
<b>YOUR BOAT – PEOPLE</b>		<b>DAMAGE TO YOUR OTHER PROPERTY: (NOT BOAT)</b> Briefly summarize any damage to your other property (not boat)
# people on board (including operator):		
# people being towed (e.g., on tubes, skis):		
# people wearing lifejackets (on board or towed):		
<b>OTHER BOATS INVOLVED IN ACCIDENT</b>		
# of other boats involved:		

For each question below, please provide answers IF APPLICABLE AND IF KNOWN, otherwise leave blank.													
<b>YOUR BOAT</b>													
<b>BOAT IDENTIFICATION</b>													
Your Boat Name:						Manufacturer:							
Model Name:						Model Year:							
Registration #:						Documentation #:							
Hull Identification # (HIN):						Rented: <input type="checkbox"/> Yes <input type="checkbox"/> No							
<b>SIZE ESTIMATES</b>													
Length: ft.		Depth from transom (stern) to keel (bottommost point): ft.				in.		Beam width at widest point: ft.					
<b>HULL MATERIAL</b>													
Type of Hull Material (select one)													
Fiberglass			Wood			Rubber/vinyl/canvas			Other (describe):				
Aluminum			Steel			Plastic							
<b>BOAT TYPE</b>													
Boat Type (select one)						Available Propulsion (select all that apply)							
Cabin motorboat		Inflatable boat		Personal watercraft (PWC) (e.g., Wave Runner™, Jet Ski™, Sea-Doo™)		Paddlecraft:		Propeller		Air thrust			
Open motorboat		Houseboat				Canoe		Sail		Other (describe):			
Auxiliary sail		Sail (only)		Air boat		Kayak		Manual					
Pontoon boat		Rowboat		Other (describe):		Standup Paddleboard		Water jet					
<b>ENGINE</b>													
# Engines:			Engine type and horsepower (select one)						Fuel type (select all that apply)				
Manufacturer			Outboard		Sterndrive		Inboard		Pod drive		Gas		Electric
Total horsepower: hp			No engine		Other:				Diesel		Other:		
<b>SAFETY MEASURES</b>													
Organizations that have conducted a vessel safety check (VSC) on board your boat within the past year (including carriage of safety equipment, e.g., lifejackets, anchor and line, fire extinguishers):													
US Coast Guard Auxiliary: VSC Decal? <input type="checkbox"/> Yes <input type="checkbox"/> No				Federal Agency (Name):									
US Power Squadrons: VSC Decal? <input type="checkbox"/> Yes <input type="checkbox"/> No				State Agency (Name):									
				Other Agency (Name):									
# Life jackets on board:		# Fire extinguishers on board:		Type of fire extinguishers (e.g., ABC):									
		# Fire extinguishers used:											
<b>ACCIDENT DETAILS – EXTERNAL CONDITIONS</b>													
<b>WEATHER</b>													
Overall weather was (select one)				It was (select one)		Visibility was (select one)			Wind was (select one)				
Clear		Raining		Day		Good			0 mph (none)				
Cloudy		Snowing		Night		Fair			Over 0, up to 12 mph (light)				
Foggy		Hazy					Poor			Over 12, up to 25 mph (moderate)			
Other (describe):				Approximate air temperature:		°F			Over 25, up to 55 mph (strong)				
									Over 55 mph (stormy)				
<b>WATER</b>													
Overall water conditions (select one):						Other water conditions:							
Up to 6 in. waves (calm)						Approximate water temperature:			°F				
Over 6 in., up to 2 ft. waves (choppy)						Strong current?			Yes		No		
Over 2 ft., up to 6 ft. waves (rough)						Hazardous waters? (e.g., rapid tidal flow, currents)			Yes		No		
Over 6 ft. waves (very rough)						Congested waters?			Yes		No		

For each question below, please provide answers IF APPLICABLE AND IF KNOWN, otherwise leave blank.			
<b>ACCIDENT DETAILS – ACTIVITIES AND OPERATIONS ON YOUR BOAT</b>			
<b>OPERATOR/PASSENGER ACTIVITIES</b>			
Operator/passenger activities on <i>your</i> boat at time of accident:			
Activities were (select one)		Operator/Passenger activities (select all that apply)	
<input type="checkbox"/> Recreational	<input type="checkbox"/> Fishing	<input type="checkbox"/> Tubing	<input type="checkbox"/> Starting engine
<input type="checkbox"/> Commercial	<input type="checkbox"/> Hunting	<input type="checkbox"/> Water Skiing	<input type="checkbox"/> Making repairs
	<input type="checkbox"/> White water activity (e.g., rafting)	<input type="checkbox"/> Relaxing	<input type="checkbox"/> Other (list):
<b>BOAT OPERATIONS</b>			
Your boat operations at time of accident (select all that apply)			
<input type="checkbox"/> Cruising (underway under power)	<input type="checkbox"/> Drifting	<input type="checkbox"/> Racing	<input type="checkbox"/> Towing another vessel
<input type="checkbox"/> Changing direction	<input type="checkbox"/> At anchor	<input type="checkbox"/> Rowing/paddling	<input type="checkbox"/> Launching
<input type="checkbox"/> Changing speed	<input type="checkbox"/> Being towed	<input type="checkbox"/> Docking/undocking	<input type="checkbox"/> Tied to dock/mooring
<input type="checkbox"/> Sailing	<input type="checkbox"/> Other (list):		
<b>ACCIDENT DETAILS – CONTRIBUTING FACTORS ON YOUR BOAT</b>			
<b>CONTRIBUTING FACTORS</b>			
Indicate factors on <i>your</i> boat which may have contributed to this accident (select all that apply)			
<input type="checkbox"/> Alcohol use	<input type="checkbox"/> Improper lookout	<input type="checkbox"/> Dam/lock	<input type="checkbox"/> Starting in gear
<input type="checkbox"/> Drug use	<input type="checkbox"/> Operator inattention	<input type="checkbox"/> Force of wake/wave	<input type="checkbox"/> Sharp turn
<input type="checkbox"/> Excessive speed	<input type="checkbox"/> Operator inexperience	<input type="checkbox"/> Hazardous waters	<input type="checkbox"/> Restricted vision (e.g., fog)
<input type="checkbox"/> Improper anchoring	<input type="checkbox"/> Language barrier	<input type="checkbox"/> Heavy weather	<input type="checkbox"/> Mission/inadequate aids to navigation (e.g., buoy, daymarker)
<input type="checkbox"/> Improper loading	<input type="checkbox"/> Navigation rules violation	<input type="checkbox"/> Ignition of fuel or vapor	<input type="checkbox"/> Inadequate on-board navigation lights
<input type="checkbox"/> Overloading	<input type="checkbox"/> Failure to vent	<input type="checkbox"/> Hull failure	<input type="checkbox"/> People on gunwale, bow or transom
<input type="checkbox"/> Other (describe):			
<b>ACCIDENT DETAILS – YOUR BOAT</b>			
<b>MACHINERY/EQUIPMENT FAILURE</b>			
Failure of the following machinery/equipment on <i>your</i> boat contributed to this accident (select all that apply)			
<input type="checkbox"/> Engine	<input type="checkbox"/> Onboard lights	<input type="checkbox"/> Shift	<input type="checkbox"/> Sound equipment (e.g., horn, whistle)
<input type="checkbox"/> Electrical system	<input type="checkbox"/> Seats	<input type="checkbox"/> Radio	<input type="checkbox"/> Auxiliary equipment
<input type="checkbox"/> Fuel system	<input type="checkbox"/> Steering	<input type="checkbox"/> Fire extinguisher	<input type="checkbox"/> Other (list):
<input type="checkbox"/> Sail/mast	<input type="checkbox"/> Throttle	<input type="checkbox"/> Ventilation	
<input type="checkbox"/> Onboard navigation aids (e.g., GPS)			
<b>ACCIDENT DETAILS – EVENTS ON YOUR BOAT</b>			
<b>ACCIDENT EVENTS</b>			
Types of events occurring to/on <i>your</i> boat during accident (select all that apply)			
<input type="checkbox"/> Collision with recreational boat	<input type="checkbox"/> Flooding/swamping	<input type="checkbox"/> Person fell overboard	
<input type="checkbox"/> Collision with commercial boat (e.g., tug, barge)	<input type="checkbox"/> Fire/explosion – fuel	<input type="checkbox"/> Person fell on/within boat	
<input type="checkbox"/> Collision with fixed object (e.g., dock, bridge)	<input type="checkbox"/> Fire/explosion – non-fuel	<input type="checkbox"/> Sudden medical condition	
<input type="checkbox"/> Collision with submerged object (e.g., stump, cable)	<input type="checkbox"/> Carbon monoxide exposure	<input type="checkbox"/> Person struck by boat	
<input type="checkbox"/> Collision with floating object (e.g., log, buoy)	<input type="checkbox"/> Mishap of skier, tuber, wake boarder, etc.	<input type="checkbox"/> Person struck by propeller or propulsion unit	
<input type="checkbox"/> Capsizing	<input type="checkbox"/> Person left boat voluntarily	<input type="checkbox"/> Person electrocuted	
<input type="checkbox"/> Grounding	<input type="checkbox"/> Person ejected from boat (caused by collision or maneuver)		
<input type="checkbox"/> Sinking	<input type="checkbox"/> Other (describe):		

For each question below, please provide answers IF APPLICABLE AND IF KNOWN, otherwise leave blank.									
<b>ACCIDENT DETAILS – YOUR BOAT- INJURED PEOPLE RECEIVING OR IN NEED OF TREATMENT BEYOND FIRST AID</b>									
<i>Report only injured people on, struck by, or being towed by your boat, receiving or in need of treatment beyond first aid. Do not report injured people on, struck by, or being towed by another boat or no boat (e.g., swimmers, people on a dock). If more than one injured person to report, attach additional copies of this page. If none, SKIP INJURED PEOPLE section.</i>									
<b>INJURED PERSON</b>									
First Name			MI		Last Name				
Street									
City			State			Zip			
Phone			Date of Birth (mm/dd/yyyy)			Age			
<b>INJURY DETAILS</b>									
<b>Injury caused when person (select all that apply)</b>					<b>Nature of most serious injury (select one)</b>				
Struck the (e.g., boat, water):					Scrape/bruise		Dislocation		
Was struck by a (e.g., boat, propeller):					Cut		Internal organ injury		
Was exposed to carbon monoxide poisoning					Sprain/strain		Amputation		
Received an electric shock					Concussion/brain injury		Burn		
Other (describe):					Spinal cord injury		Other (describe):		
Person was wearing lifejacket?			Yes	No	Broken/fractured bone				
Person received treatment beyond first aid?			Yes	No	Body part of most serious injury (e.g., head, trunk, leg):				
Person was admitted to a hospital?			Yes	No					
<b>ACCIDENT DETAILS – YOUR BOAT – DEATHS/DISAPPEARANCES</b>									
<i>Only report deaths/disappearances of people on, struck by, or being towed by your boat. If more than one death/disappearance to report, attach additional copies of this page. If none, SKIP DEATHS/DISAPPEARANCES section.</i>									
<b>PERSON WHO DIED/DISAPPEARED</b>									
First Name			MI		Last Name				
Street									
City			State			Zip			
Phone			Date of Birth (mm/dd/yyyy)			Age			
<b>DETAILS OF DEATH/DISAPPEARANCE</b>									
<b>Injury caused when person (select all that apply)</b>					<b>Nature of death/disappearance (select one)</b>				
Struck the (e.g., boat, water):					Death – by drowning				
Was struck by a (e.g., boat, propeller):					Death – other likely cause (describe)				
Was exposed to carbon monoxide poisoning									
Received an electric shock					Disappeared and not yet recovered				
Other (describe):					Person was wearing lifejacket?		Yes	No	



For each question below, please provide answers IF APPLICABLE AND IF KNOWN, otherwise leave blank.							
<b>ACCIDENT DETAILS – YOUR BOAT OPERATOR</b>							
<b>OPERATOR INSTRUCTION</b>				<b>OPERATOR SAFETY MEASURES</b>			
Boating safety instruction completed <i>(select all that apply)</i>				On board, prior to accident, was operator wearing:			
None				A lifejacket?		Yes	No
State course				An engine cut-off switch <i>(Lanyard or wireless device)</i> if equipped?		Yes	No
USCG Auxiliary course				On board, prior to accident, was operator using:			
US Power Squadrons course				Alcohol?		Yes	No
Internet <i>(name of sponsoring organization)</i>				Drugs?		Yes	No
Other <i>(describe)</i>				Operator arrested for Boating Under the Influence?		Yes	No
				Weather reports consulted prior to accident?		Yes	No
<b>OPERATOR EXPERIENCE</b>							
Experience operating this type of boat <i>(select one)</i>							
0 to 10 hours		Over 10, up to 100 hours		Over 100, up to 500 hours		Over 500 hours	
<b>ACCIDENT DETAILS – OTHER KEY PEOPLE</b>							
Only report other key people not already documented as injured, died, disappeared or operator/owner of your boat. If more than two other key people to report, attach additional copies of this page.							
<b>NAME/ADDRESS</b>							
This other key person was a(n) <i>(select all that apply)</i>							
<input type="checkbox"/> Other boat operator <input type="checkbox"/> Other boat owner <input type="checkbox"/> Owner of other damaged property <input type="checkbox"/> Passenger on your boat <input type="checkbox"/> Witness							
First Name			MI	Last Name			
Street							
City			State	Zip	Phone		
Other boat name <i>(if any)</i>				Other boat registration # <i>(if any)</i>			
<b>NAME/ADDRESS</b>							
This other key person was a(n) <i>(select all that apply)</i>							
<input type="checkbox"/> Other boat operator <input type="checkbox"/> Other boat owner <input type="checkbox"/> Owner of other damaged property <input type="checkbox"/> Passenger on your boat <input type="checkbox"/> Witness							
First Name			MI	Last Name			
Street							
City			State	Zip	Phone		
Other boat name <i>(if any)</i>				Other boat registration # <i>(if any)</i>			

For each question below, please provide answers IF APPLICABLE AND IF KNOWN, otherwise leave blank.					
<b>YOUR BOAT OPERATOR</b>					
<b>NAME/ADDRESS</b>					
First Name	MI	Last Name			
Street					
City	State	Zip			
<b>AGE/GENDER/PHONE</b>					
Date of Birth <small>(mm/dd/yyyy)</small>	Age	Gender	Male	Female	Phone
<b>YOUR BOAT OWNER</b>					
If same as <i>your boat operator</i> SKIP rest of YOUR BOAT OWNER section.					
<b>NAME/ADDRESS/PHONE</b>					
First Name	MI	Last Name			
Street					
City	State	Zip	Phone		
<b>PERSON SUBMITTING THIS REPORT</b>					
If same as <i>your boat operator</i> OR <i>owner</i> , SKIP rest of PERSON SUBMITTING THIS REPORT section.					
<b>NAME/ADDRESS/PHONE/ROLE</b>					
First Name	MI	Last Name			
Street					
City	State	Zip	Phone		
<b>I was a(n) (select one)</b>					
<input type="checkbox"/>	Other person on board <i>this</i> boat				
<input type="checkbox"/>	Accident witness <i>not</i> on board <i>this</i> boat				
<input type="checkbox"/>	Other ( <i>describe</i> ):				
<b>SIGNATURE OF PERSON SUBMITTING THIS REPORT</b>					
<b>Your signature</b>				<b>Date (mm/dd/yyyy)</b>	
<p>An Agency may not conduct or sponsor and a person is not required to respond to an information collection, unless it displays a currently valid OMB Control Number.</p> <p>The Coast Guard estimates that the average burden for this report form is 30 minutes. You may submit any comments concerning the accuracy of this burden estimate or any suggestions for reducing the burden to: Commandant (CG-BSX-21), U.S. Coast Guard, Washington, DC 20593-0001 or Office of Management and Budget, Paperwork Reduction Project (1625-0003), Washington, DC 20503.</p>					



www.cgaux.org

# FLOAT PLAN

INSTRUCTIONS: Complete this plan before you go boating and leave it with a reliable person who can be depended upon to notify the Coast Guard, or other rescue agency, should you not return or check-in as planned. If you have a change of plans, or will be delayed, notify the person holding your Float Plan. Finally, close your plan by notifying the holder you have arrived home safely and if the holder has reported you overdue, notify all applicable rescue authorities of your safe return.



www.uscgboating.org

**Do NOT file this plan with the Coast Guard**

## VESSEL

### IDENTIFICATION:

Name & Hailing Port \_\_\_\_\_  
 Document / Registration No. \_\_\_\_\_ HIN \_\_\_\_\_  
 Year, Make & Model \_\_\_\_\_  
 Length \_\_\_\_\_ Type \_\_\_\_\_ Draft \_\_\_\_\_ Hull Mat. \_\_\_\_\_  
 Hull & Trim Colors \_\_\_\_\_  
 Prominent Features \_\_\_\_\_

### COMMUNICATION:

Radio Call Sign / Number \_\_\_\_\_  
 DSC MMSI No. \_\_\_\_\_  
 Radio-1: Type \_\_\_\_\_ Ch. / Freq. Monitored \_\_\_\_\_  
 Radio-2: Type \_\_\_\_\_ Ch. / Freq. Monitored \_\_\_\_\_  
 Cell / Satellite \_\_\_\_\_  
 Email \_\_\_\_\_

### PROPULSION:

Primary-- Type \_\_\_\_\_ Eng. \_\_\_\_\_ Fuel Capacity \_\_\_\_\_  
 Auxiliary--Type \_\_\_\_\_ Eng. \_\_\_\_\_ Fuel Capacity \_\_\_\_\_

### NAVIGATION: (Check all onboard)

Compass  Radar  GPS / DGPS  Depth Sounder  
 Charts  Maps  \_\_\_\_\_

## SAFETY & SURVIVAL

### VISUAL DISTRESS SIGNALS:

Electric Distress Light (night only)  
 Flag (day only)  
 Flare, Aerial (day & night)  
 Flare, Handheld (day & night)  
 Signal Mirror (day only)  
 Smoke (day only)

### AUDIBLE DISTRESS SIGNALS:

Bell  
 Horn  
 Whistle

### EPIRB:

UIN\* \_\_\_\_\_

### ADDITIONAL GEAR:

Anchor - Line length \_\_\_\_\_  Food for \_\_\_\_\_ days / person  
 Dewatering device  Water for \_\_\_\_\_ days / person  
 Exposure suits  \_\_\_\_\_  
 Fire Extinguisher  \_\_\_\_\_  
 Flashlight / Searchlight  \_\_\_\_\_  
 Raft / Dinghy  \_\_\_\_\_

## PERSONS ONBOARD

### OPERATOR:

Name \_\_\_\_\_  
 Address \_\_\_\_\_  
 City \_\_\_\_\_ State \_\_\_\_\_ Zip Code \_\_\_\_\_  
 Age \_\_\_\_\_ Gender \_\_\_\_\_ PFD  PLB UIN\* \_\_\_\_\_  
 Note \_\_\_\_\_  
 Float Plan Note \_\_\_\_\_

Has experience with:  this vessel;  the boating area(s).  
 Home Phone \_\_\_\_\_  
 Vehicle (Year, Make & Model) \_\_\_\_\_  
 Vehicle License No. \_\_\_\_\_ Trailer   
 Vehicle parked at \_\_\_\_\_

### PASSENGERS / CREW: (Identify all on board)

Name	Home Phone	Age	Gender	PFD	Note
1. _____	_____	_____	_____	<input type="checkbox"/>	_____
2. _____	_____	_____	_____	<input type="checkbox"/>	_____
3. _____	_____	_____	_____	<input type="checkbox"/>	_____
4. _____	_____	_____	_____	<input type="checkbox"/>	_____
5. _____	_____	_____	_____	<input type="checkbox"/>	_____
6. _____	_____	_____	_____	<input type="checkbox"/>	_____
7. _____	_____	_____	_____	<input type="checkbox"/>	_____
8. _____	_____	_____	_____	<input type="checkbox"/>	_____
9. _____	_____	_____	_____	<input type="checkbox"/>	_____
10. _____	_____	_____	_____	<input type="checkbox"/>	_____
11. _____	_____	_____	_____	<input type="checkbox"/>	_____
12. _____	_____	_____	_____	<input type="checkbox"/>	_____

Passenger PLB UIN\*  
 (Not listed in a specific order)

If you have a genuine concern for the safety or welfare of the persons onboard this vessel that have not returned or checked-in, in a reasonable amount of time, then follow the step-by-step instructions on the Boating Emergency Guide™ located on the last page of this Float Plan.

(\*) EPIRB and PLB registration required by Federal regulations. [www.beaconregistration.noaa.gov](http://www.beaconregistration.noaa.gov)



www.cgaux.org

## FLOAT PLAN continued

INSTRUCTIONS: Complete this plan before you go boating and leave it with a reliable person who can be depended upon to notify the Coast Guard, or other rescue agency, should you not return or check-in as planned. If you have a change of plans, or will be delayed, notify the person holding your Float Plan. Finally, close your plan by notifying the holder you have arrived home safely and if the holder has reported you overdue, notify all applicable rescue authorities of your safe return.

**Do NOT file this plan with the U.S. Coast Guard**



www.uscgboating.org

**CONTACTS**

Contact 1 \_\_\_\_\_ Phone Number \_\_\_\_\_

Contact 2 \_\_\_\_\_ Phone Number \_\_\_\_\_

Rescue Authority \_\_\_\_\_ Phone Number \_\_\_\_\_

**ITINERARY**

		DATE	TIME	LOCATION / WAYPOINT	MODE OF TRAVEL	REASON FOR STOP	CHECK-IN TIME
1	Depart						
	Arrive						
2	Depart						
	Arrive						
3	Depart						
	Arrive						
4	Depart						
	Arrive						
5	Depart						
	Arrive						
6	Depart						
	Arrive						
7	Depart						
	Arrive						
8	Depart						
	Arrive						
9	Depart						
	Arrive						
10	Depart						
	Arrive						
11	Depart						
	Arrive						
12	Depart						
	Arrive						
13	Depart						
	Arrive						
14	Depart						
	Arrive						
15	Depart						
	Arrive						
16	Depart						
	Arrive						
17	Depart						
	Arrive						
18	Depart						
	Arrive						
19	Depart						
	Arrive						
20	Depart						
	Arrive						
21	Arrive						

If you have a genuine concern for the safety or welfare of the persons onboard this vessel that have not returned or checked-in, in a reasonable amount of time, then follow the step-by-step instructions on the Boating Emergency Guide™ located on the last page of this Float Plan.

**USCG Float Plan - BOATING EMERGENCY GUIDE™**

**BEFORE YOU BEGIN** – This guide is designed to work either with or without a Float Plan. You will need the following items: 1) the Float Plan, if one was given to you; 2) a pen or pencil; 3) a clean sheet of paper or writing tablet; and 4) your local telephone directory.

**Step 1:** Do you have a genuine concern for the safety or welfare of any persons who have not returned or checked-in, in a reasonable amount of time?

If **yes**, then continue with **Step 2**. Otherwise **STOP** – no further action is required at this time.

**Step 2:** Were you given a prepared Float Plan by anyone on board the vessel?

If **yes**, then continue with **Step 3**. Otherwise, go to **Step 5**.

**Step 3:** Locate the Contacts at the top of page 2 on the Float Plan. Call Contact number 1...

IF CONTACT #1	THEN						
Answers phone	Take notes during your conversation. <ol style="list-style-type: none"> <li>Let the person know you are responding to a late return or check-in by the individuals designated on the Float Plan.</li> <li>Determine if the person you are talking to, or anyone else at that location, has recently had contact with anyone on the vessel, and when and where that contact occurred.</li> <li>Are you still concerned about the safety or welfare of any persons on board the vessel?</li> </ol> <table border="1"> <thead> <tr> <th>IF</th> <th>THEN</th> </tr> </thead> <tbody> <tr> <td>Yes</td> <td>Continue with <b>Step 4</b>.</td> </tr> <tr> <td>No</td> <td><b>STOP</b>. No further action is required.</td> </tr> </tbody> </table>	IF	THEN	Yes	Continue with <b>Step 4</b> .	No	<b>STOP</b> . No further action is required.
IF	THEN						
Yes	Continue with <b>Step 4</b> .						
No	<b>STOP</b> . No further action is required.						
Does not answer phone	Continue with <b>Step 4</b> .						

**Step 4:** Call Contact number 2...

IF CONTACT #2	THEN						
Answers phone	Take notes during your conversation. <ol style="list-style-type: none"> <li>Let the person know you are responding to a late return or check-in by the individuals designated on the Float Plan.</li> <li>Determine if the person you are talking to, or anyone else at that location, has recently had contact with anyone on the vessel, and when and where that contact occurred.</li> <li>Are you still concerned about the safety or welfare of any persons on board the vessel?</li> </ol> <table border="1"> <thead> <tr> <th>IF</th> <th>THEN</th> </tr> </thead> <tbody> <tr> <td>Yes</td> <td>Continue with <b>Step 6</b>.</td> </tr> <tr> <td>No</td> <td><b>STOP</b>. No further action is required.</td> </tr> </tbody> </table>	IF	THEN	Yes	Continue with <b>Step 6</b> .	No	<b>STOP</b> . No further action is required.
IF	THEN						
Yes	Continue with <b>Step 6</b> .						
No	<b>STOP</b> . No further action is required.						
Does not answer phone	Continue with <b>Step 6</b> .						

**Step 5:** Using the checklist below, jot down only what you know about each item:

**DO NOT SPECULATE.** Incorrect information may mislead Search and Rescue personnel; add to the overall search and rescue time; and adversely affect the outcome.

- Period of time the vessel has been overdue.
- Purpose of the trip or voyage.
- Description of vessel. (Type, size, color, features, etc.)
- Vessel's departure point and destination.
- Places the vessel planned to stop during transit.
- Navigation equipment aboard. (Examples: GPS, radar, compass, sounder, etc.)
- Number of persons aboard. Relevant characteristics such as dependability, reliability, etc.
- Was the vessel initially docked or moored or did a vehicle tow it to a launch point?
- License plate number and description of the tow vehicle and/or the passenger's transport vehicle.
- Communications equipment aboard, including type of radio and frequencies monitored, cellular or satellite telephone numbers of individuals, etc.
- Additional points of contact along the vessel's planned route.
- Operator and/or a passenger/crew member absolutely had to be back at the scheduled return time.
- Call your local Rescue Authority that responds to marine emergencies (Police, Sheriff, Constable, First responder, etc.).

Go to **Step 6-2**.

**Step 6:**

- Call the Rescue Authority contact at the top of page 2 on the Float Plan.
- Tell the dispatcher you are responding to a late return or check-in by the persons on board the vessel.
- The dispatcher will instruct you from there.

**Note:** The dispatcher will provide you with the necessary contact or agency connection to get a search and rescue mission started. This puts you in direct contact with the agency conducting the actual search and rescue, eliminating unnecessary middlemen.  
The dispatcher will tell you if he/she desires a follow-up call on the outcome of the rescue.

4. Continue with **Step 7**.

**Step 7:** Be patient... you've done everything you can possibly do for now. It is important to keep the telephone available so emergency personnel can contact you with additional information and/or questions concerning the search and rescue effort.

**STOP -- End of Guide**

Provided as a courtesy by:  
S2 Yachts, Inc.  
Holland, MI  
(616) 392-7163  
Get a Vessel Safety Check before you go boating.



The USCG Float Plan is the official Float Plan of the U.S. Coast Guard and U.S. Coast Guard Auxiliary. For more information visit:

[www.floatplancentral.org](http://www.floatplancentral.org)



Problem	Cause and Solution
<b>Control Systems</b>	
<p><b>Hydraulic steering is slow to respond and erratic.</b></p>	<ul style="list-style-type: none"> <li>• Steering system is low on fluid. Fill and bleed system.</li> <li>• Steering system has air in it. Fill and bleed system.</li> <li>• A component in the steering system is binding. Check and adjust or repair binding component.</li> <li>• Engine steering cylinder is binding. Grease spindle.</li> </ul>
<p><b>The boat wanders and will not hold a course at cruise speeds.</b></p>	<ul style="list-style-type: none"> <li>• There could be air in the steering system. Fill &amp; bleed the system.</li> <li>• The engine steering tab is corroded or out of adjustment. Replace or adjust steering tab.</li> <li>• Engine steering cylinder is binding. Grease spindle.</li> </ul>
<p><b>The engine will not start with the shift control lever in neutral.</b></p>	<ul style="list-style-type: none"> <li>• The control cable is out of adjustment &amp; not activating the neutral safety cut out switch.</li> <li>• The shift control lever is not in the neutral detent. Try moving the shift lever slightly.</li> <li>• There is a loose wire on the neutral safety switch on the transmission. Inspect wires and repair loose connections.</li> <li>• The starter or ignition switch is bad.</li> </ul>
<b>Performance Problems</b>	
<p><b>Boat is sluggish and has lost speed and RPM.</b></p>	<ul style="list-style-type: none"> <li>• The boat may be need to have marine growth cleaned from hull and running gear.</li> <li>• Propeller may be damaged &amp; need repair.</li> <li>• Weeds or line around the propeller. Clean propeller.</li> <li>• Boat is overloaded. Reduce load.</li> <li>• Check for excessive water in the bilge. Pump out bilge &amp; find &amp; correct the problem.</li> <li>• The throttle adjustments has changed and the engine is not getting full throttle. Adjust the throttle cable.</li> </ul>

Problem	Cause and Solution
<p><b>The boat vibrates at cruising speeds.</b></p>	<ul style="list-style-type: none"> <li>• Propeller may be damaged and need repair.</li> <li>• The propeller or propeller shaft is bent. Repair or replace damaged components.</li> <li>• The running gear is fouled by marine growth or rope. Clean running gear.</li> <li>• The engine is not trimmed properly. Trim the engine.</li> </ul>
<p><b>Engine Problems</b></p>	
<p><b>The engine is running too hot.</b></p>	<ul style="list-style-type: none"> <li>• The engine raw water pick-up strainer up is clogged with marine growth. Clean pick-up.</li> <li>• The engine raw water pump impeller is worn or damaged. Repair the pump.</li> <li>• The engine thermostat is faulty and needs to be replaced.</li> </ul>
<p><b>The engine alternator is not charging properly.</b></p>	<ul style="list-style-type: none"> <li>• The battery cable is loose or corroded. Clean and tighten battery cables.</li> <li>• The alternator is not charging and must be replaced.</li> <li>• The engine battery isolator in the charging system is not working properly. Replace the isolator.</li> <li>• The battery is defective. Replace the battery.</li> <li>• The alternator breaker may be in the OFF position.</li> </ul>
<p><b>The engine suddenly will not operate over 2000 RPM.</b></p>	<ul style="list-style-type: none"> <li>• The engine emergency system has been activated. The onboard computer has sensed a problem and has limited the RPM to protect the engine. Find &amp; correct the problem.</li> <li>• The tachometer is bad and needs to be replaced.</li> </ul>



Problem	Cause and Solution
<p><b>The engine is loosing RPM. The boat is not overloaded and the hull bottom and running gear are clean and in good condition.</b></p>	<ul style="list-style-type: none"> <li>• The engine may be having a problem with a sticky anti-siphon valve, located in the fuel line near the fuel tank, that is restricting the fuel flow. Remove &amp; clean or replace the anti-siphon valve.</li> <li>• The remote gasoline fuel filter could be dirty. Inspect and replace the fuel filter.</li> <li>• The primary fuel filter on the engine may be dirty. Inspect and replace the fuel filter.</li> <li>• The electronic engine control system on the engine is malfunctioning. Repair the engine control system.</li> <li>• The fuel injection system on the engine is malfunctioning. Repair the fuel injection system.</li> </ul>
<p><b>Accessory Problems</b></p>	
<p><b>The livewell pump runs, but does not pump water.</b></p>	<ul style="list-style-type: none"> <li>• The strainer on the intake scoop is clogged preventing the water from getting to the pump. Put the boat in reverse to clean the strainer.</li> <li>• There is an air lock in the system. Run the boat above 15 m.p.h. and the pick-up scoop will force the air lock past the pump and prime the system.</li> <li>• The thru-hull valve is not open. Open valve.</li> <li>• The valve in the livewell is not open. Open the valve in the livewell.</li> </ul>
<p><b>The automatic float switch on the bilge pump raises but does not activate the pump.</b></p>	<ul style="list-style-type: none"> <li>• The in-line fuse near the battery switch has blown. Replace the fuse.</li> <li>• The pump impeller is jammed by debris. Clean pump impeller housing.</li> <li>• The pump is defective. Replace pump.</li> </ul>



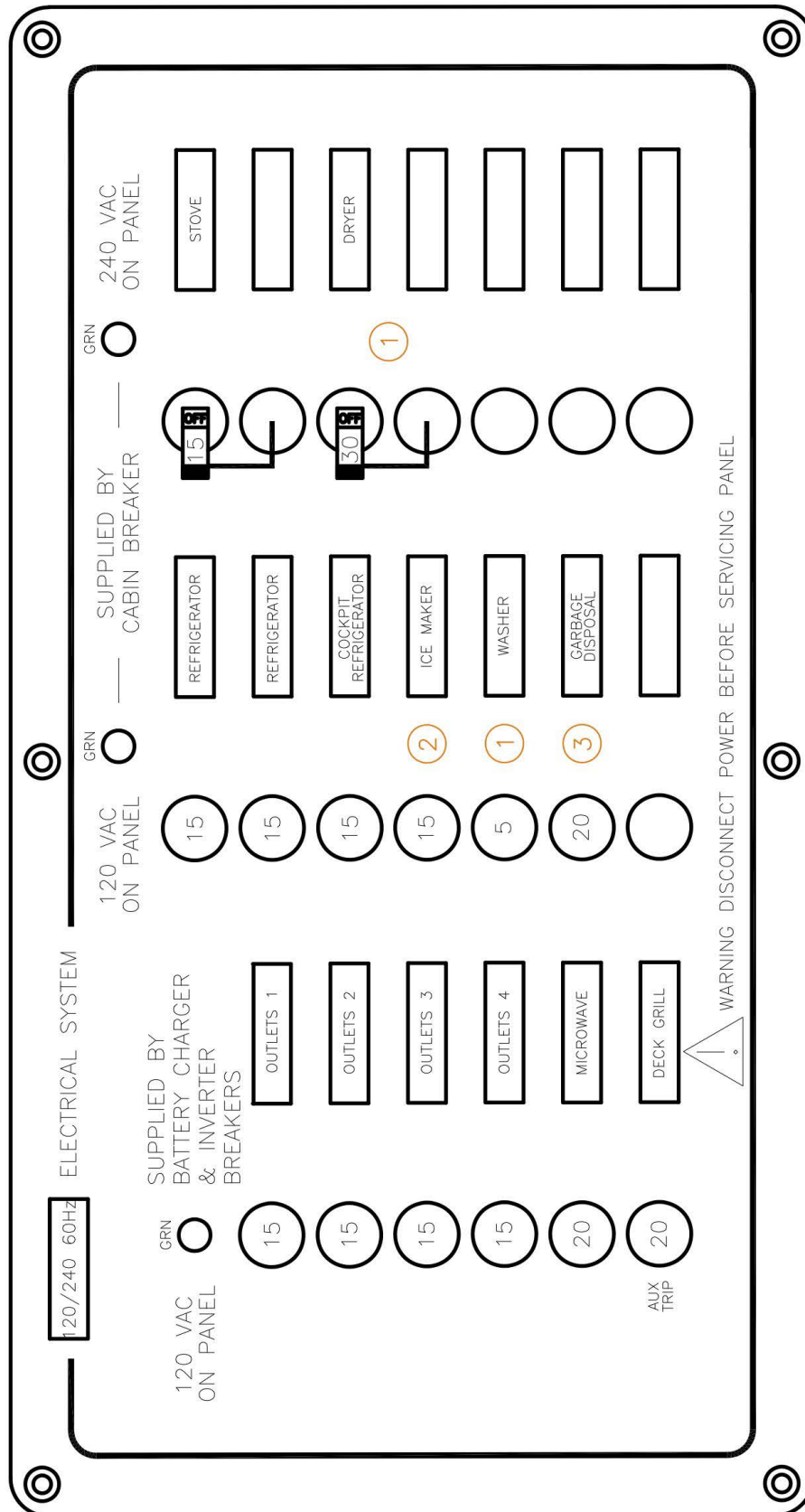

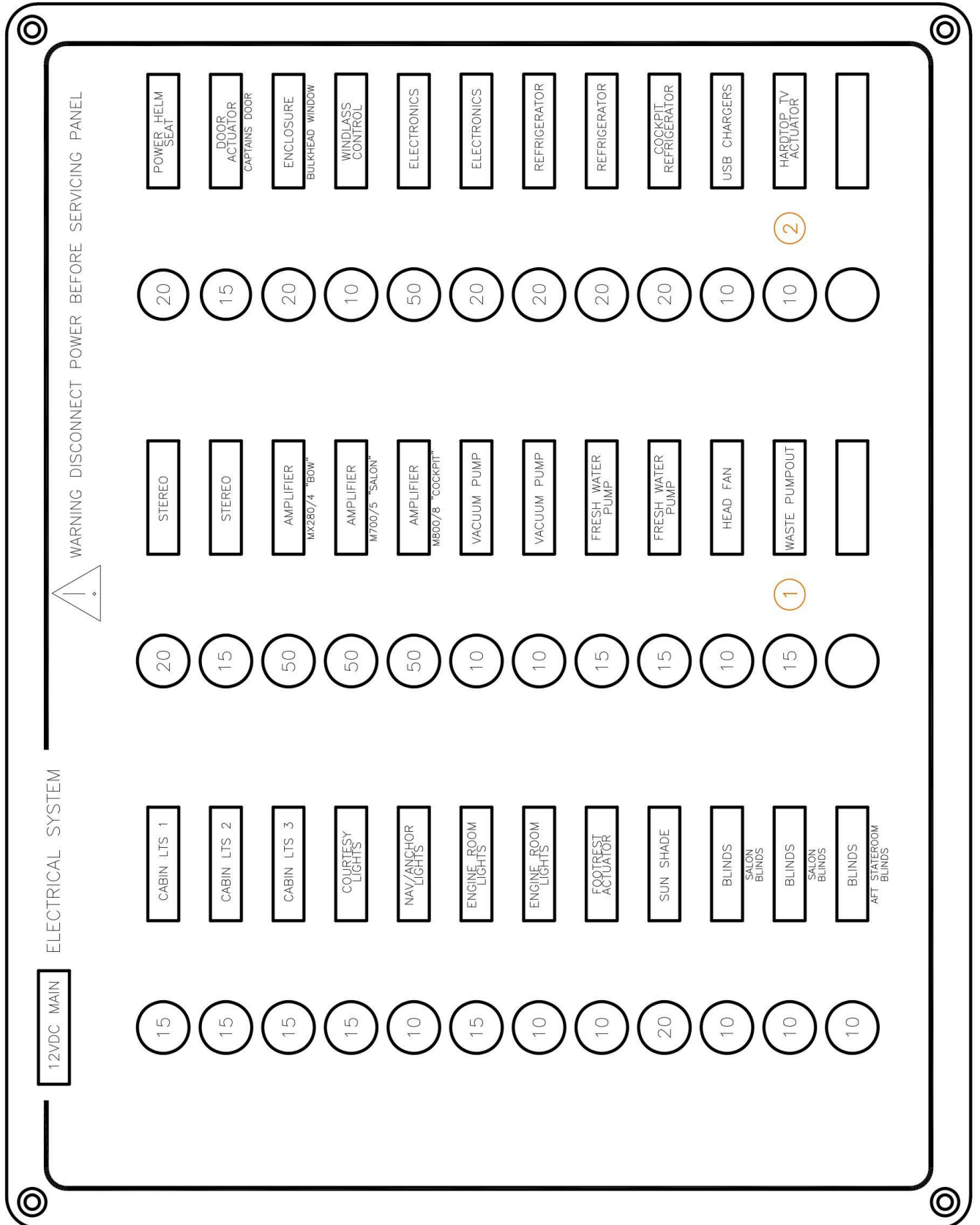

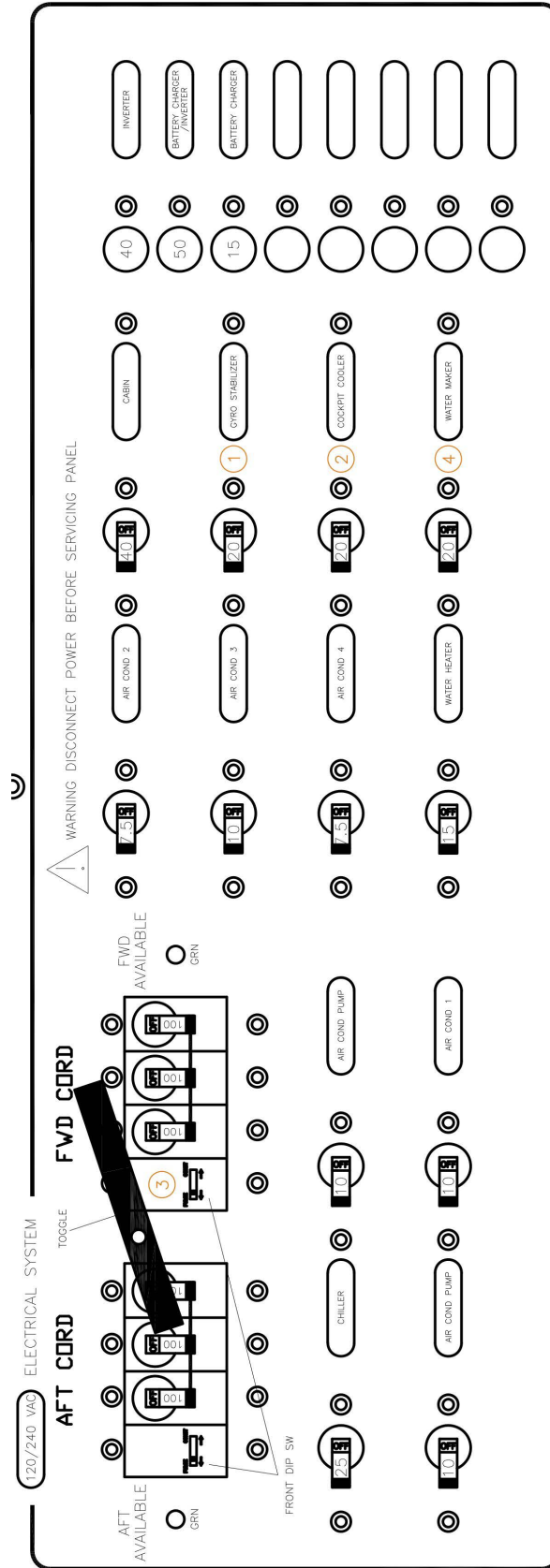

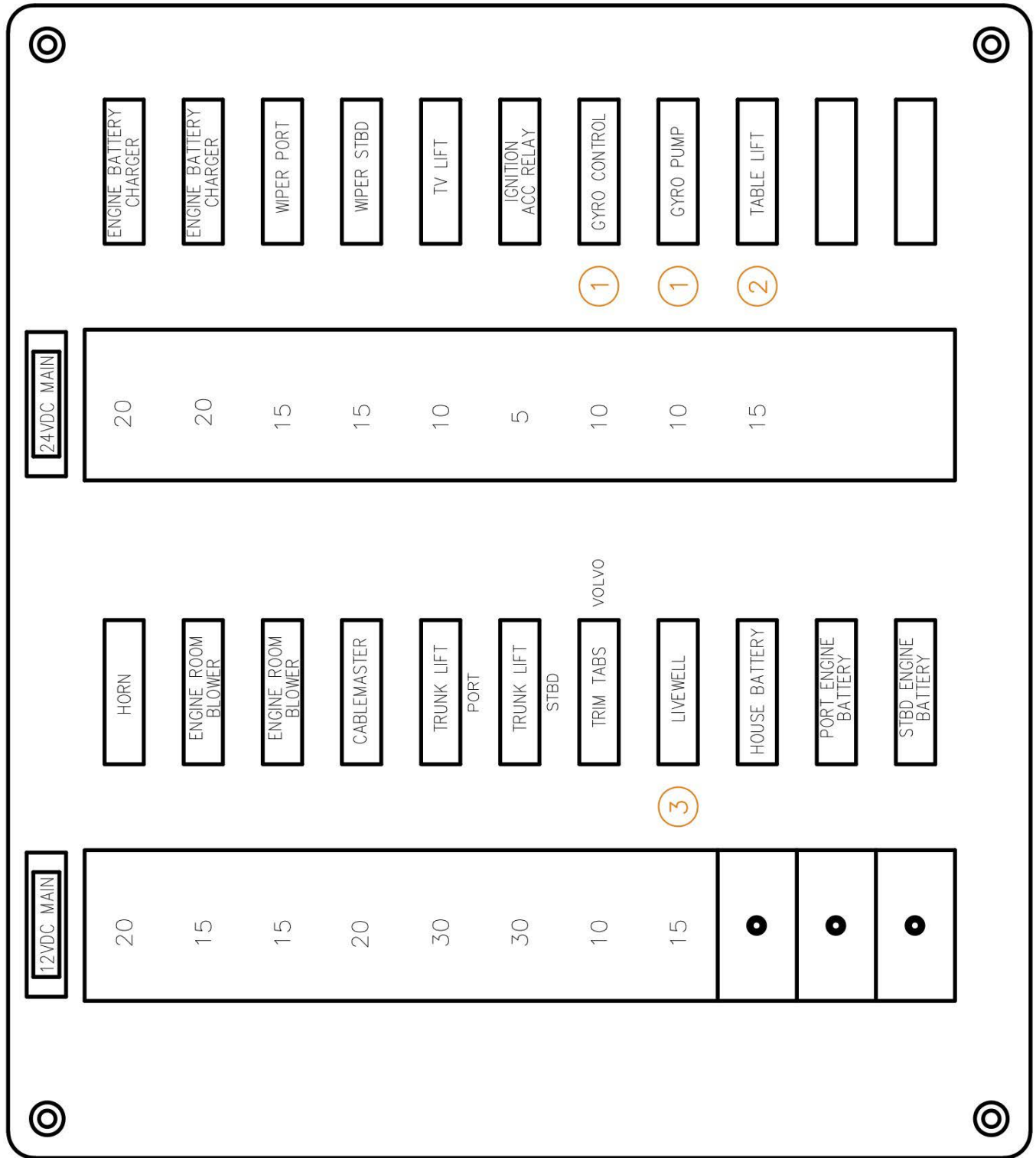

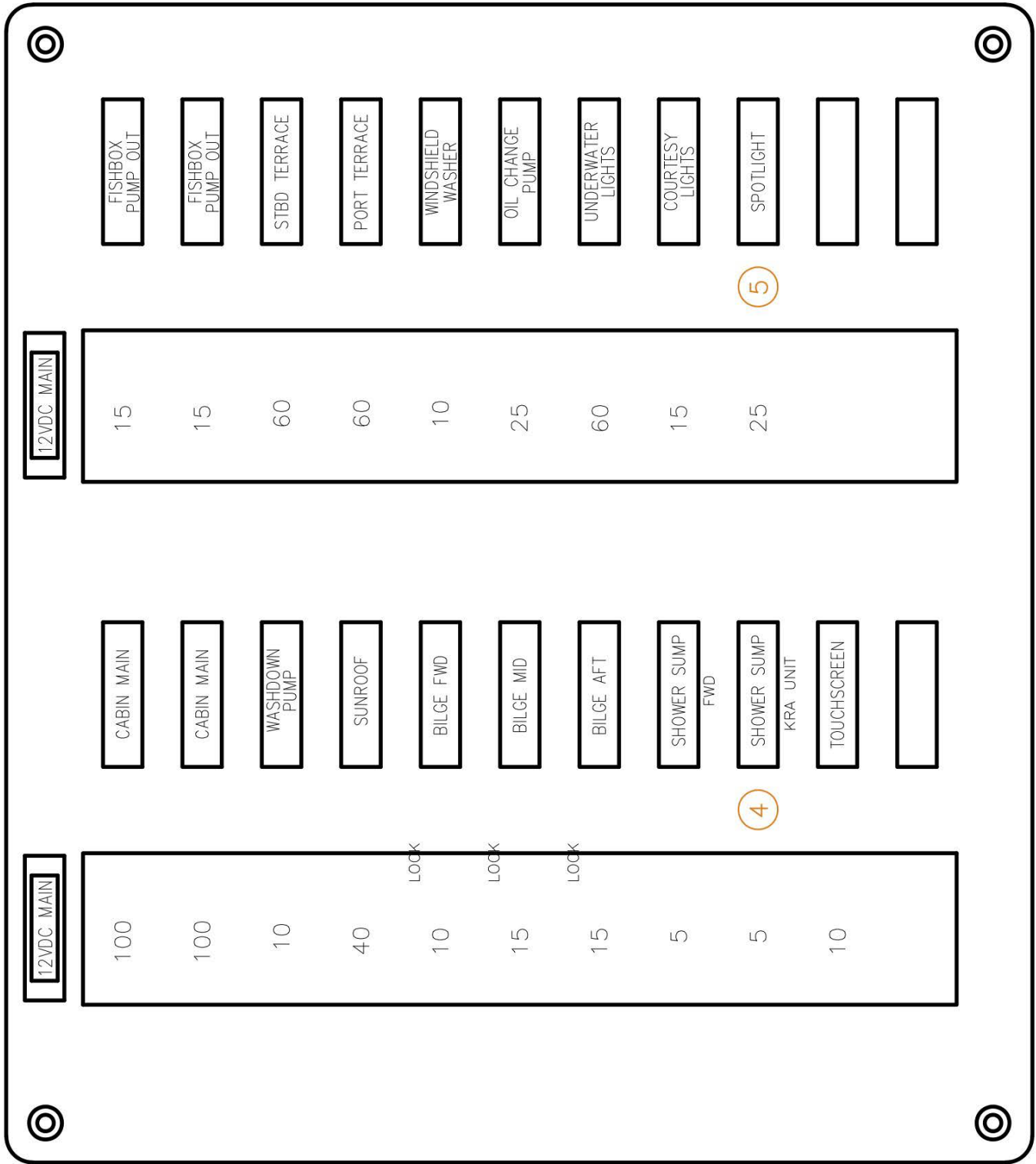

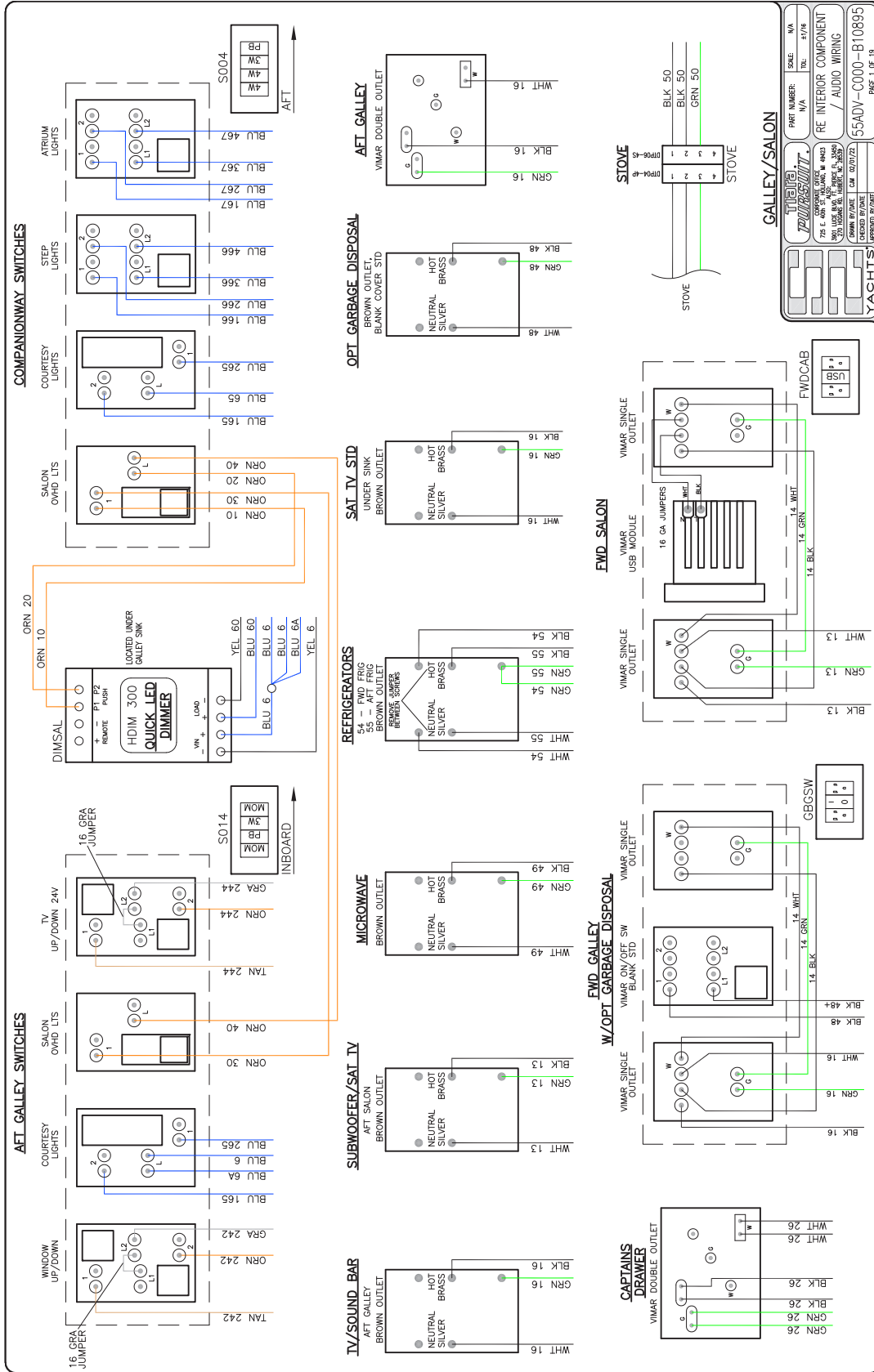

	<b>YACHTS</b> 735 E. COAST ROAD, SUITE 404 APTON, ILLINOIS 62503 (618) 291-9999 FAX: (618) 291-9999 WWW.TITANYACHTS.COM
PART NUMBER: N/A SCALE: N/A TITLE: #1/16	RE INTERIOR COMPONENT / AUDIO WIRING 55ADV-C000-B10895 DATE: 10/20/22 CHECKED BY: JAL APPROVED BY: JAL
PAGE 1 OF 19	



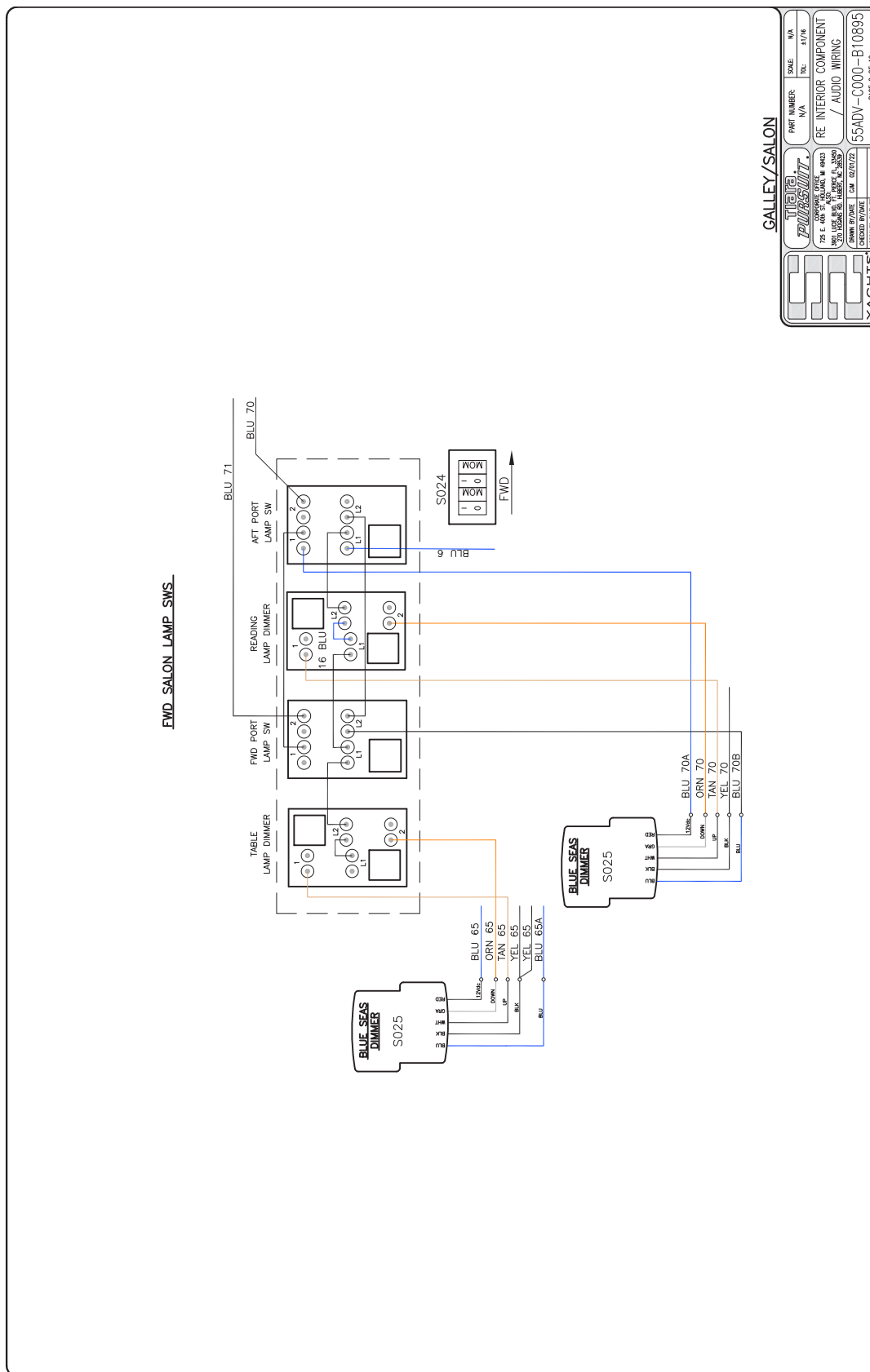

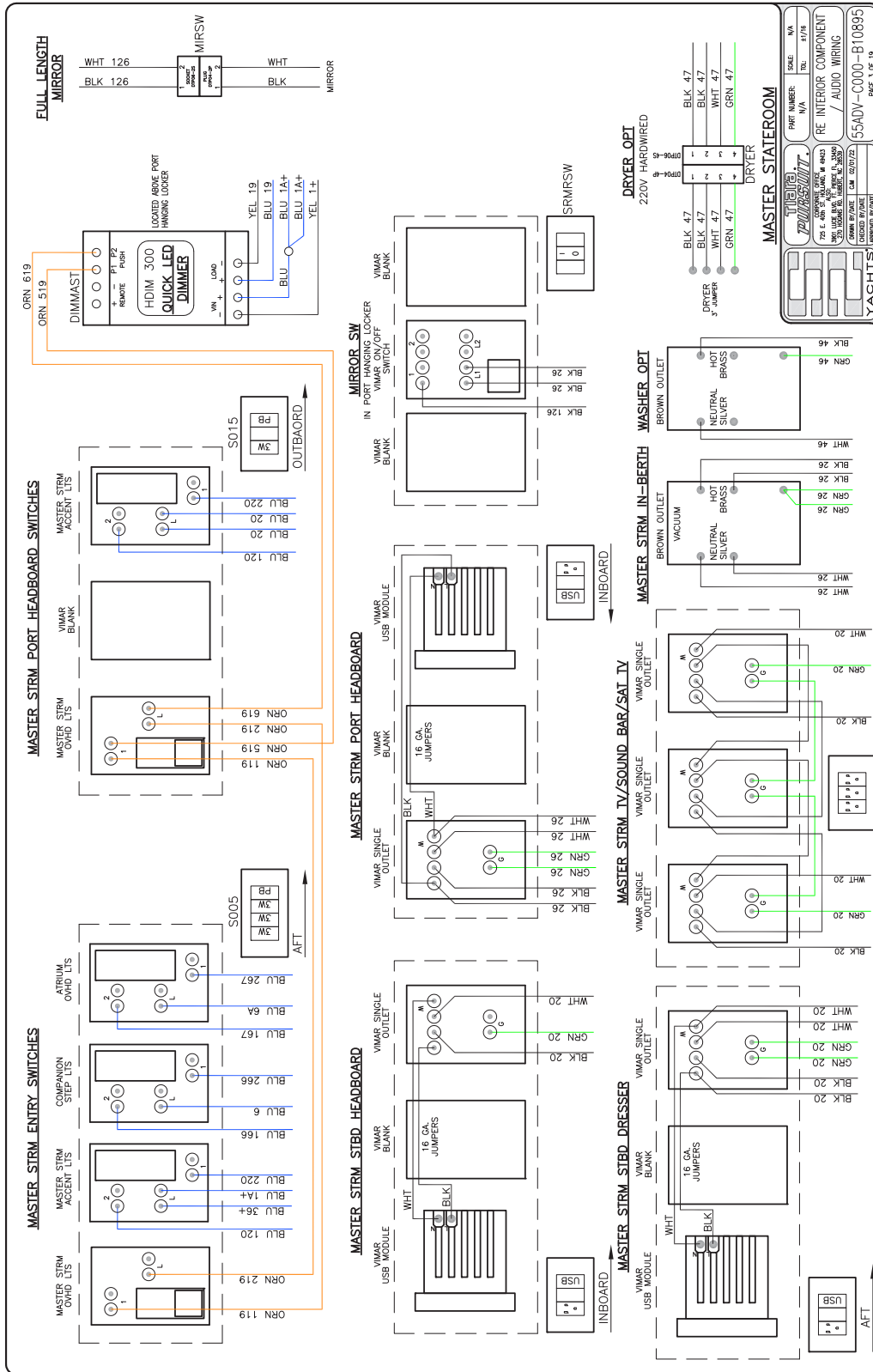

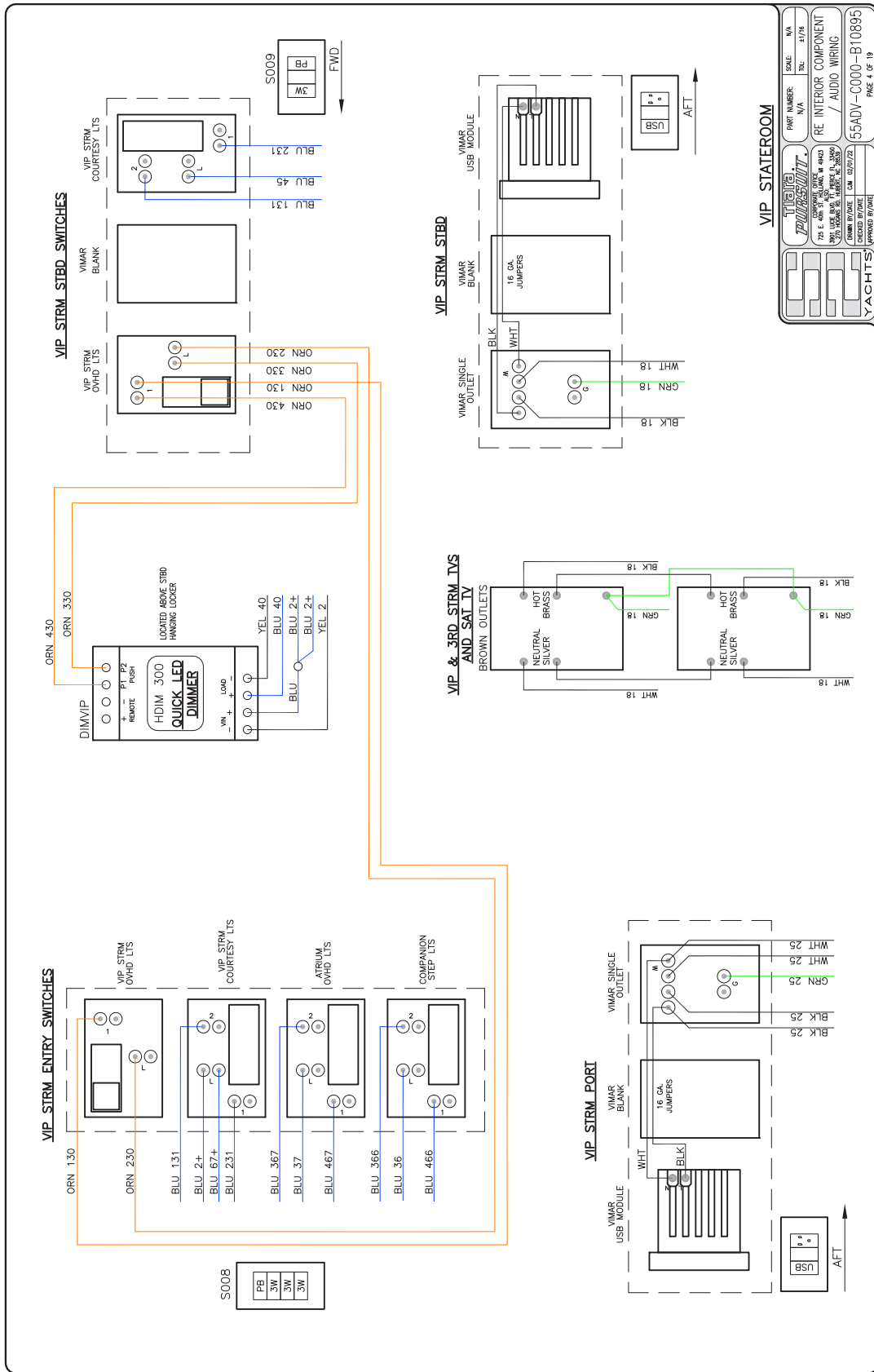

PART NUMBER: N/A		SCALE: N/A
REV: 4/17/16		
RE INTERIOR COMPONENT / AUDIO WIRING		
55ADV-C000-B10895		
DATE: 04/17/16	DESIGNED BY: CM	CHECKED BY: JAE
YACHTS		
PAGE 4 OF 19		

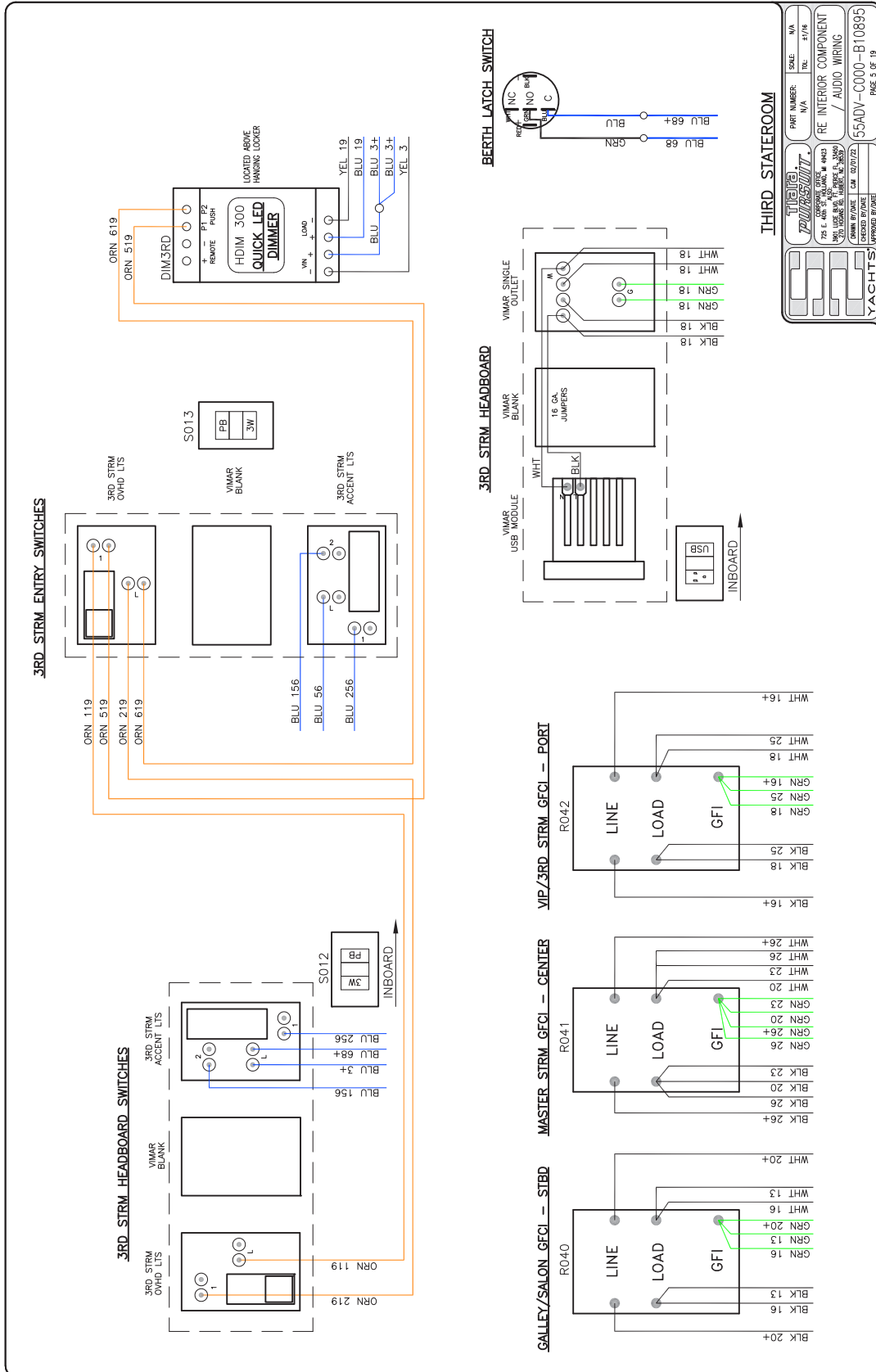

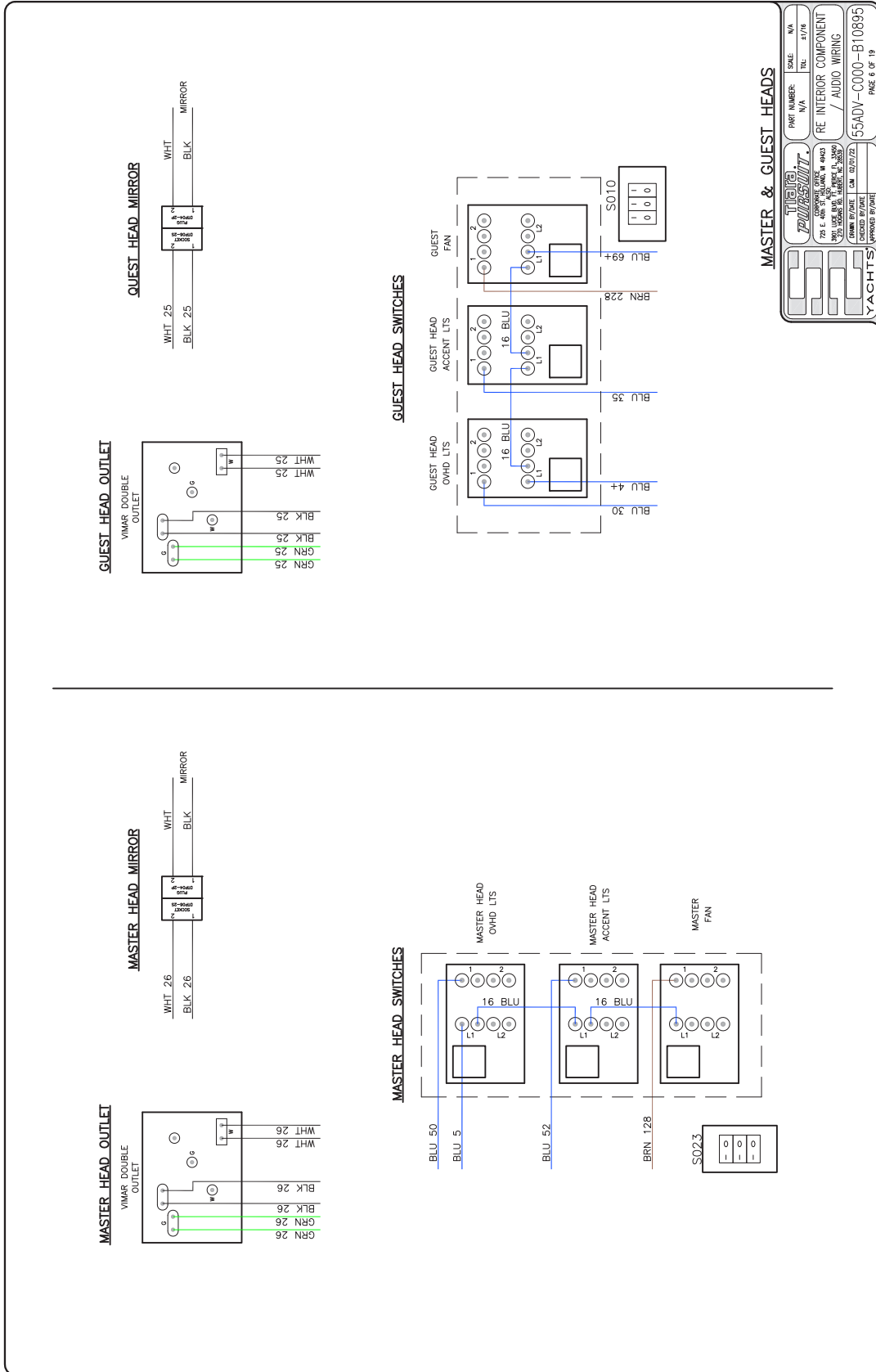

MASTER & GUEST HEADS

		SCALE: N/A DATE: 12/18
PWT NUMBER: N/A		RE INTERIOR COMPONENT / AUDIO WIRING
720 L. 2000 ST. WILMINGTON, NC 28403 WWW.YACHTS.COM TEL: 910.339.3300		DRAWN BY/DATE: CMR 02/20/22 CHECKED BY/DATE: [blank] APPROVED BY/DATE: [blank]
55ADV-C000-B10895		PAGE 6 OF 19

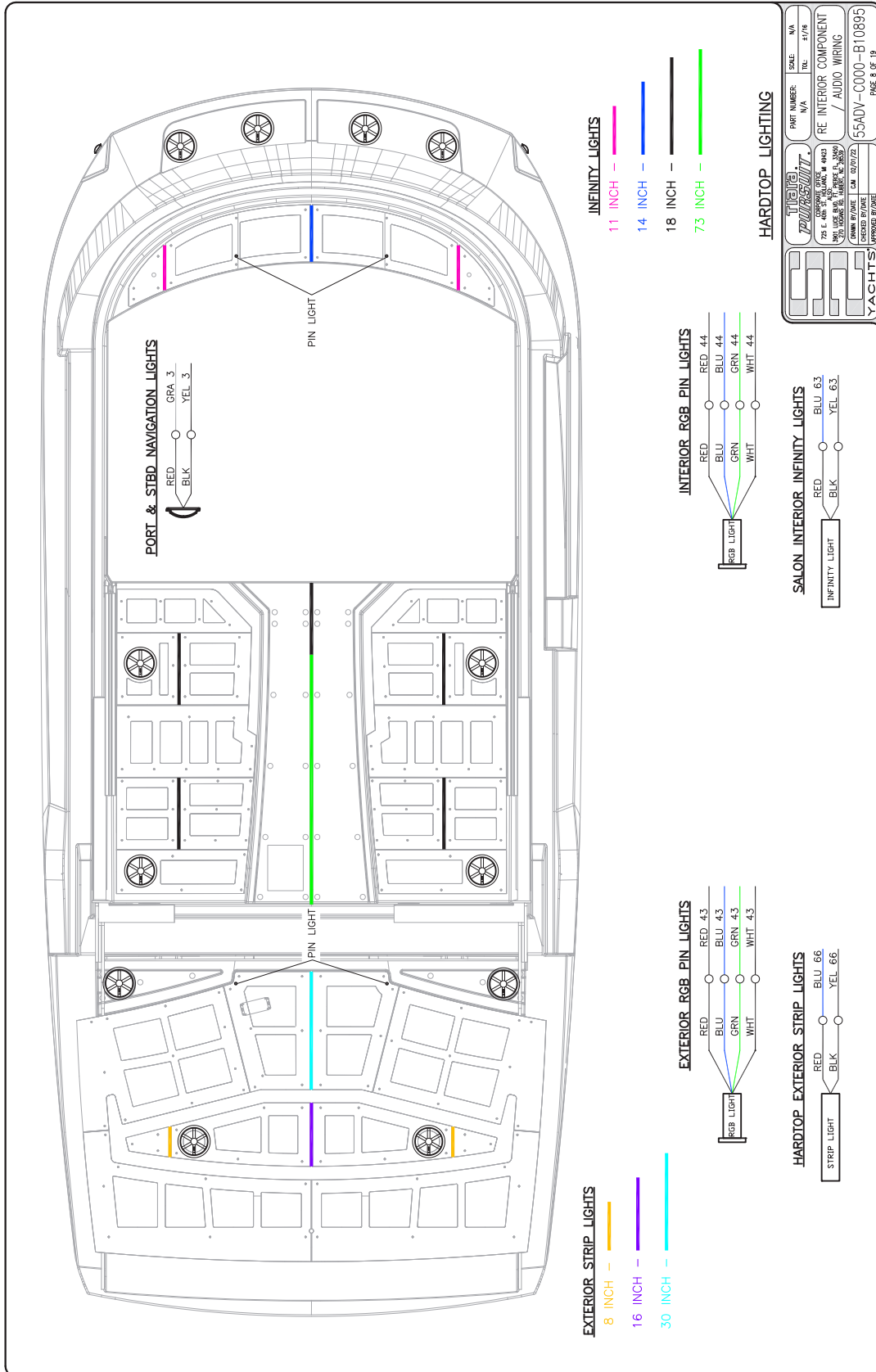

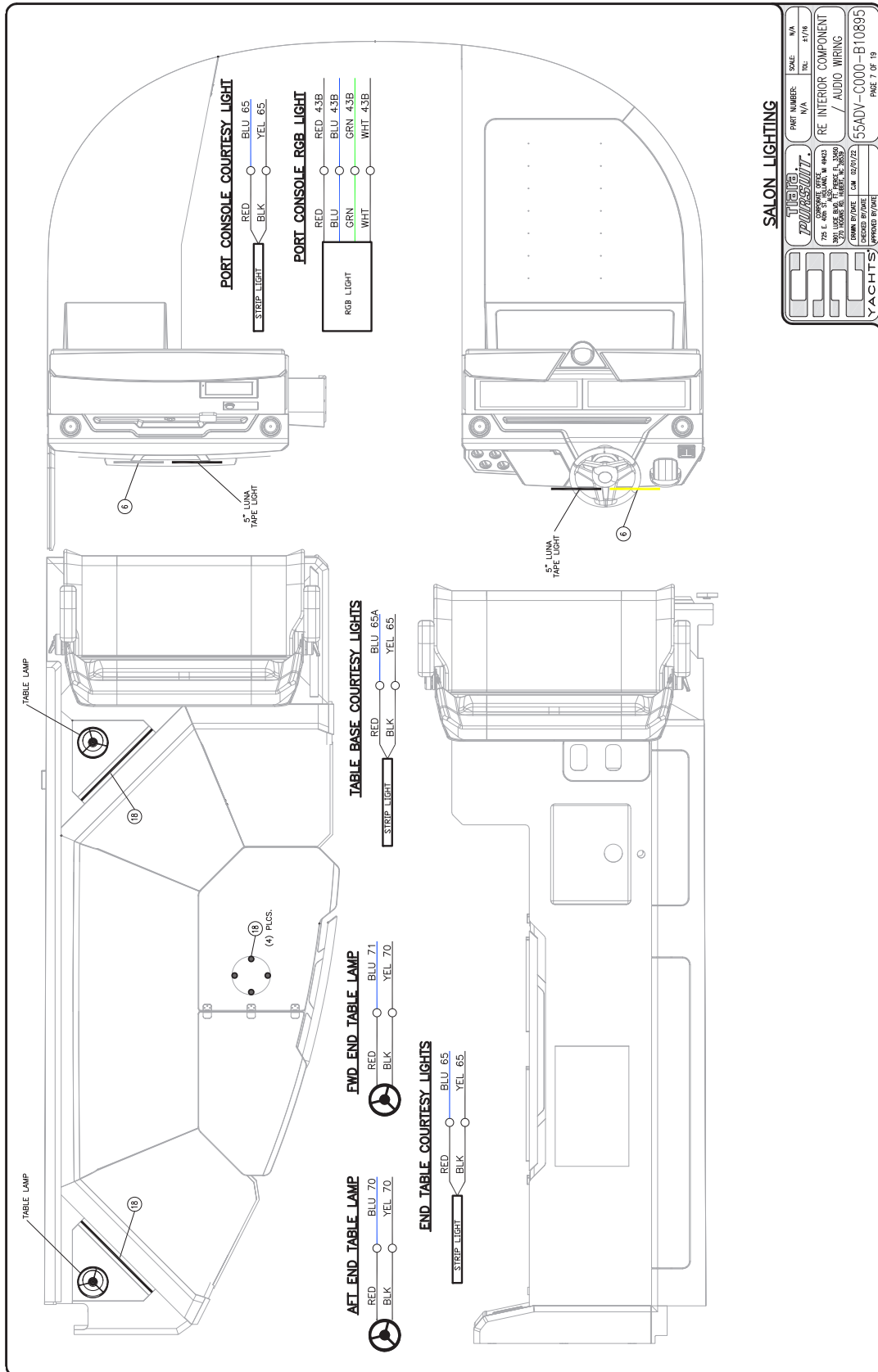

**SALON LIGHTING**

		SCALE: N/A FILE: #174
PART NUMBER: N/A		RE INTERIOR COMPONENT / AUDIO WIRING
750 L. 400 W. 100 H. (W/ 4443) 1000 L. 400 W. 100 H. (W/ 4443) (DIMENSIONS IN INCHES)		55ADV-C000-B10895 PAGE 7 OF 19
(DRAWN BY/DATE) CM 10/01/20		(CHECKED BY/DATE)
(REVISION BY/DATE)		(APPROVED BY/DATE)

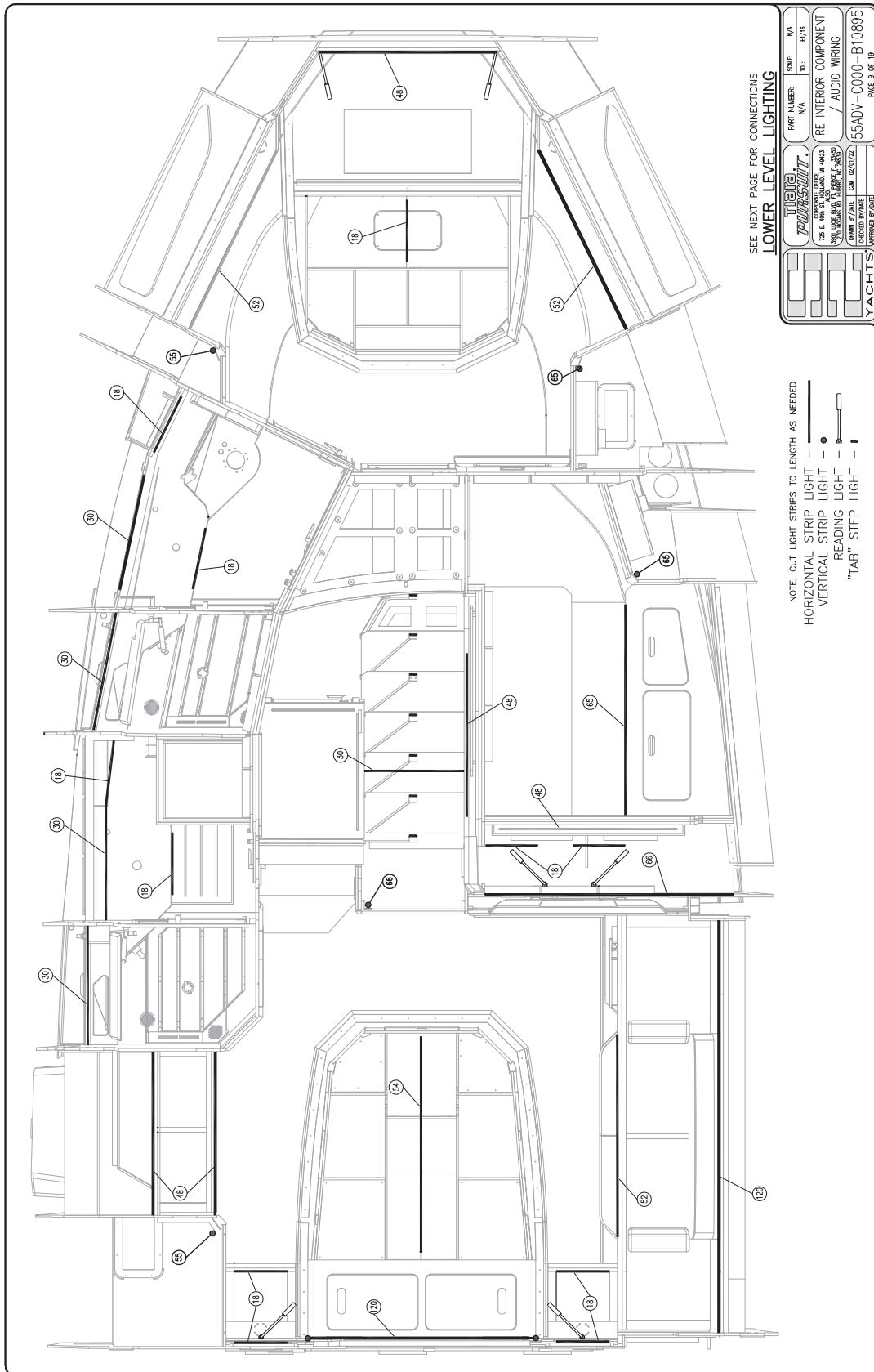



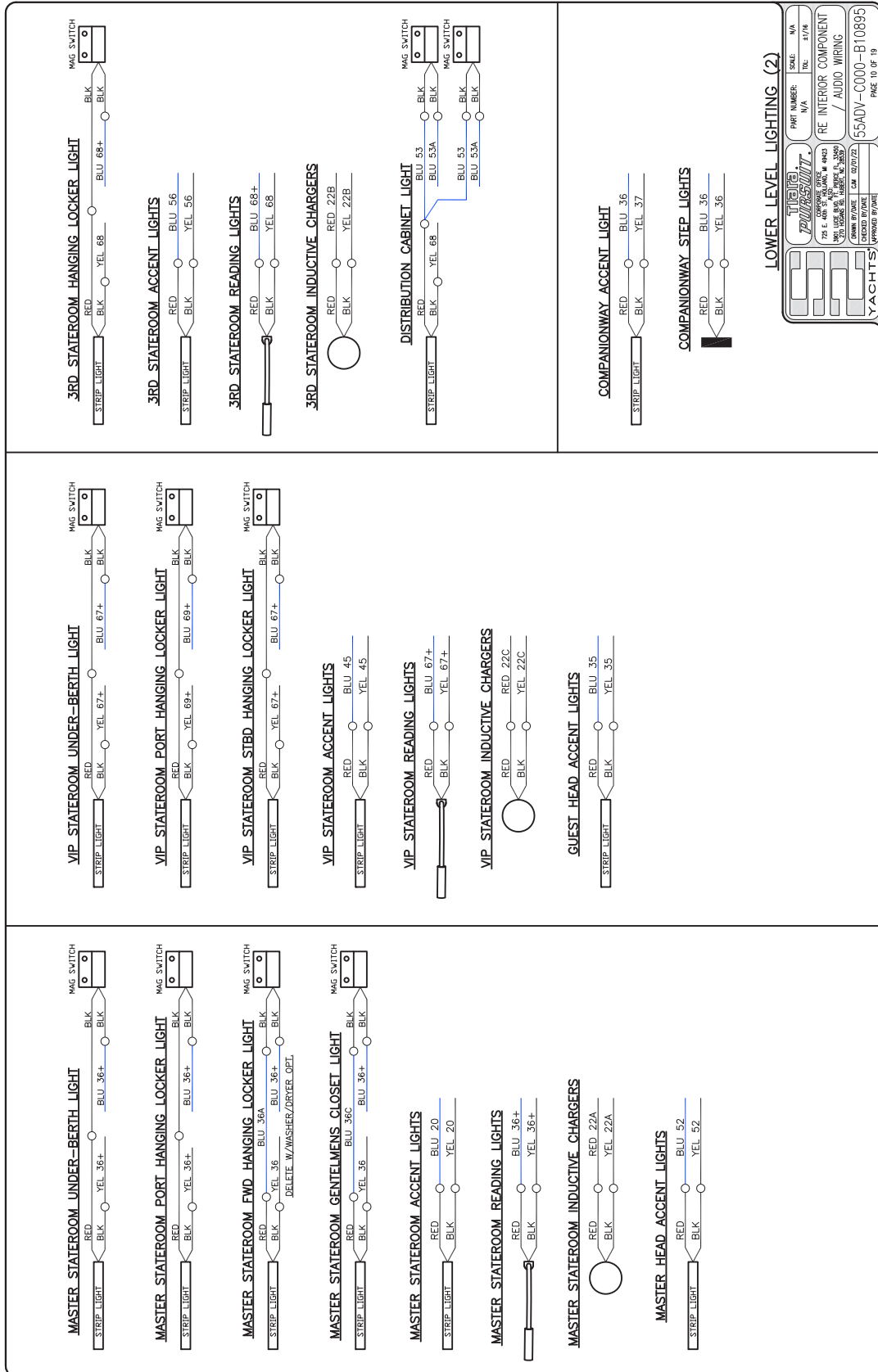

LOWER LEVEL LIGHTING (2)

		PART NUMBER: N/A ISSUE: N/A FILE: 1714
725 E. 40th St., Suite # 4943 Waukegan, IL 60087 (815) 491-9600 (815) 491-9601 FAX: (815) 491-9602		RE INTERIOR COMPONENT / AUDIO WIRING
YACHTS		55ADV-C000-B10895 PAGE 10 OF 19

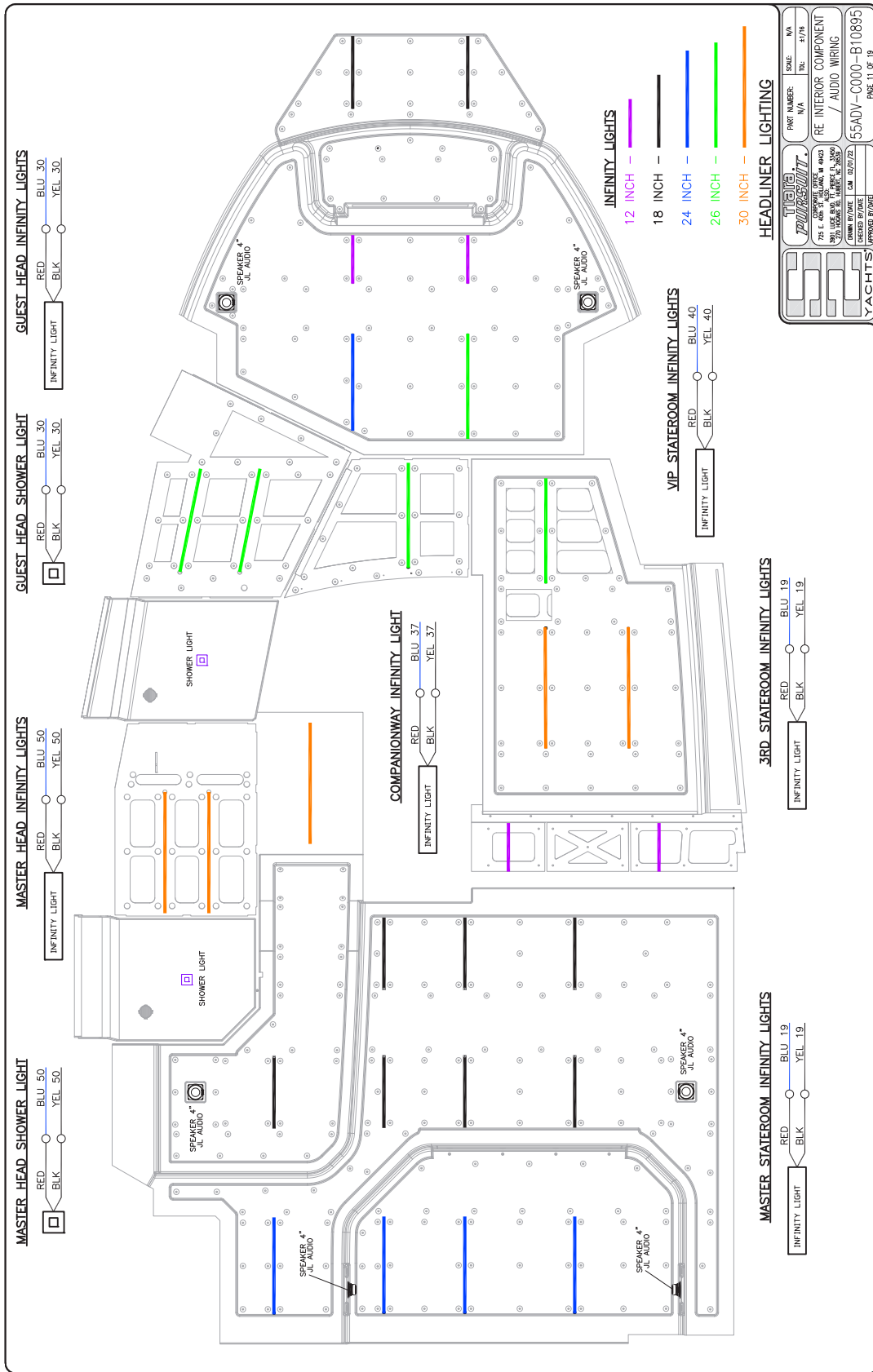

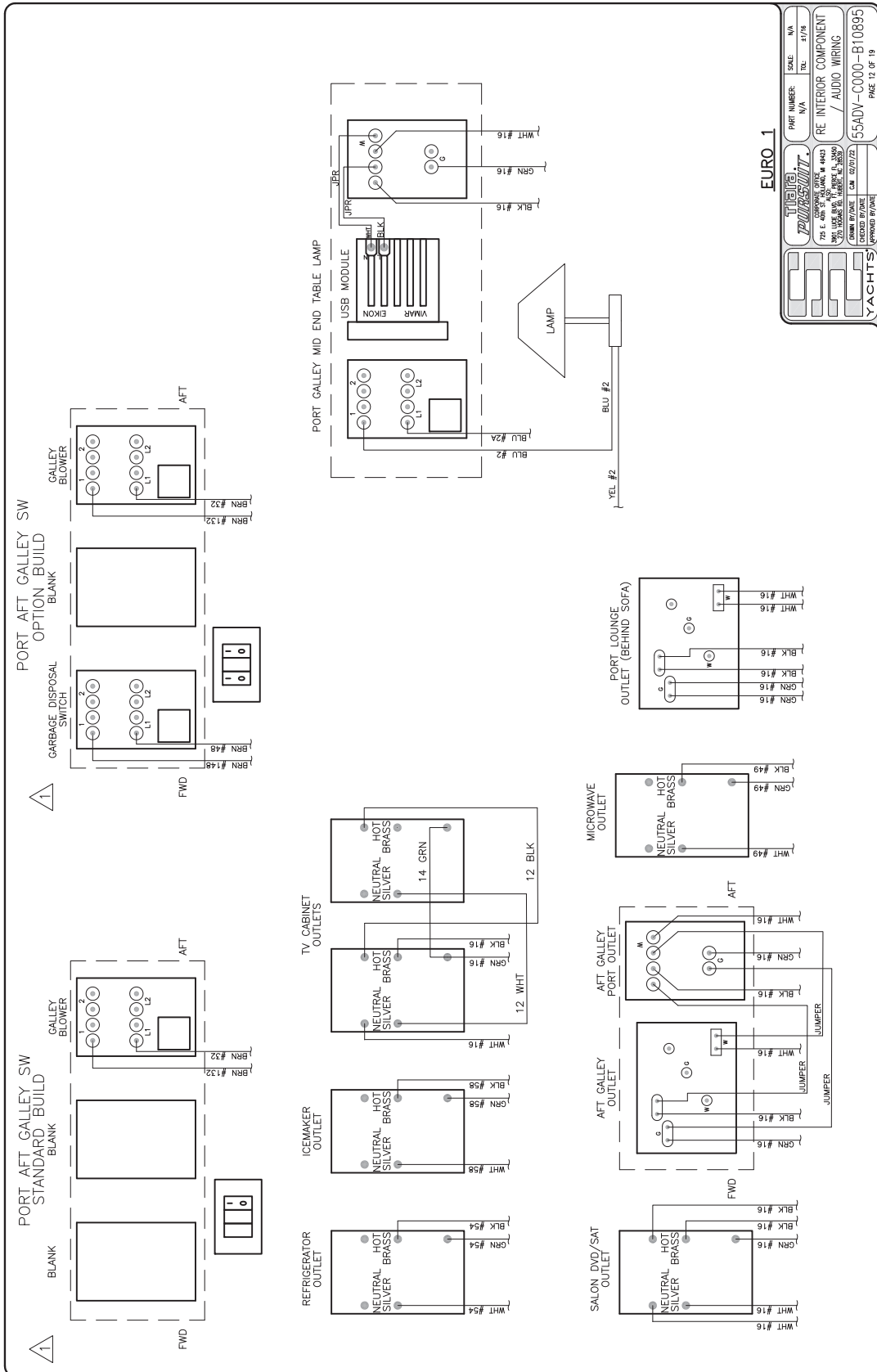

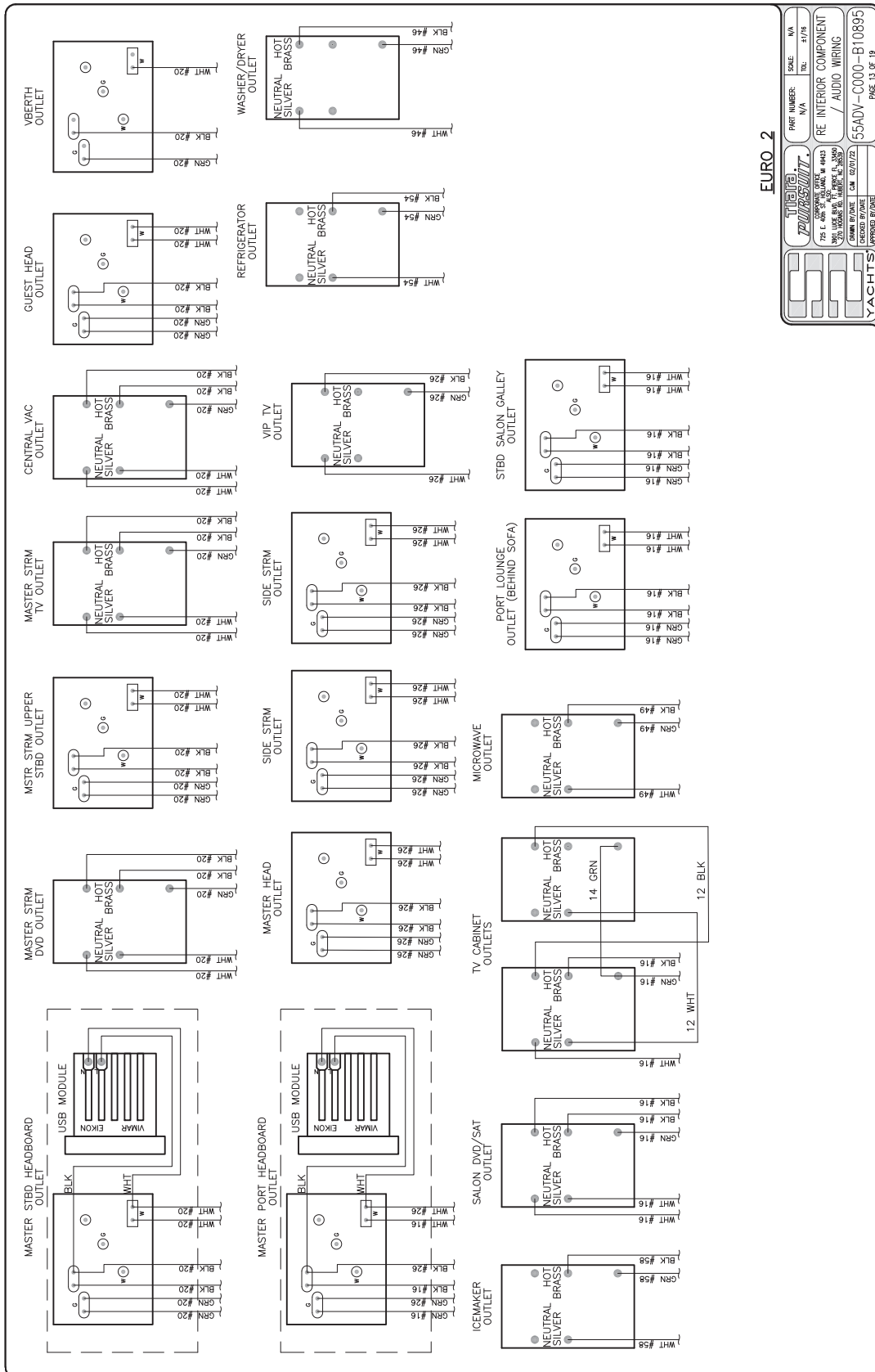

EURO 2

		PART NUMBER: N/A DATE: 4/17/16
RE INTERIOR COMPONENT / AUDIO WIRING		725 E. 42ND ST. SUITE 1000, WILSON, NJ 07093 908.686.8800 FAX: 908.686.8899 WWW.TITANICYACHTS.COM
55ADV-C000-B10895		CM: 02/17/12 CHECKED BY: [ ] APPROVED BY: [ ]
YACHTS		PAGE 13 OF 19

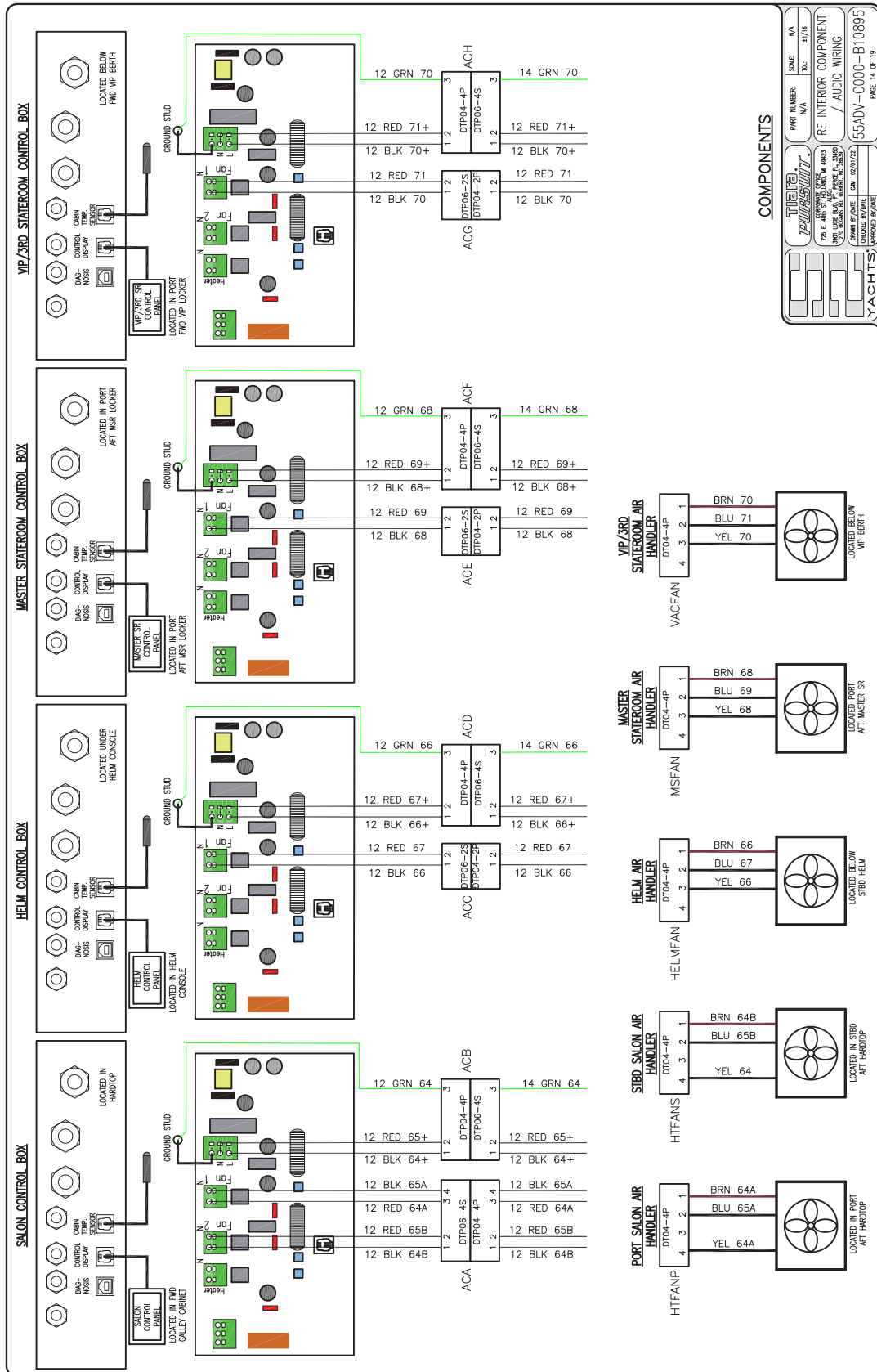

COMPONENTS

TIARA YACHTS	ISSUE: N/A	FILE: #174
725 E. 40th St., Suite # 4423 Wichita, KS 67218-3890 PHONE: 316.262.1111 FAX: 316.262.1112	PART NUMBER: N/A	RE INTERIOR COMPONENT / AUDIO WIRING
DATE: 02/27/12	DESIGNED BY/DATE: [Signature]	55ADV-C000-B10895
	DATE: 02/27/12	PAGE 14 OF 19

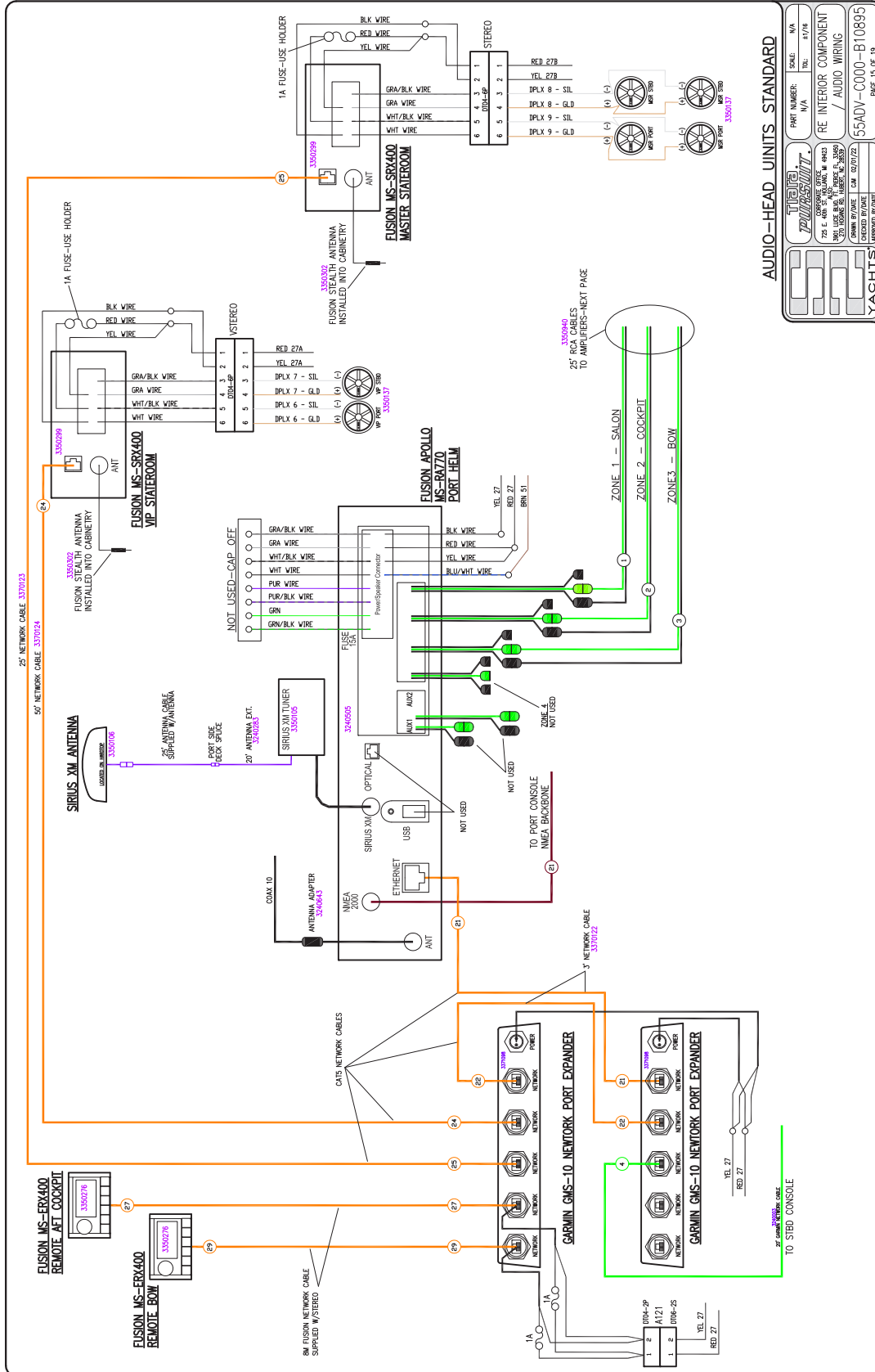

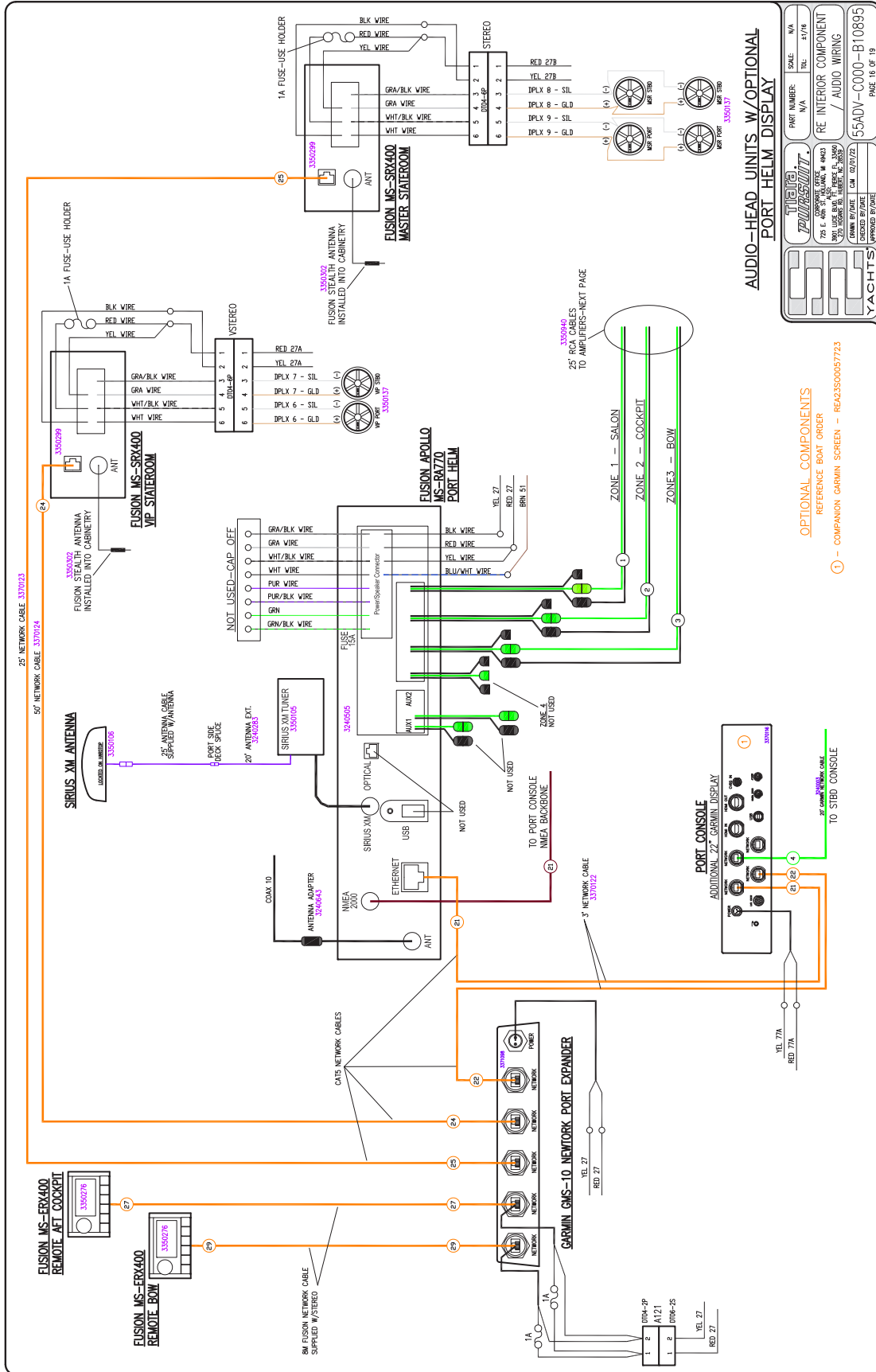

**AUDIO-HEAD UNITS W/OPTIONAL PORT HELM DISPLAY**

<b>TIARA</b> <i>YACHTS</i>	PART NUMBER: N/A	SCALE: N/A
<b>PROGRESSIVE</b>	TITLE: RE INTERIOR COMPONENT	DATE: 4/17/18
725 E. 4200 S. WALKER, UT 84043	PROJECT: / AUDIO WIRING	
3001 LACE BAY BLVD. SUITE 10, 33509	DESIGNED BY: J. HARRIS, JR.	
2701 E. 9000 S. WALKER, UT 84043	CHECKED BY: J. HARRIS, JR.	
APPROVED BY: [Signature]	DATE: 02/07/22	
<b>YACHTS</b>	55ADV-C000-B10895	PAGE 16 OF 19

OPTIONAL COMPONENTS  
REFERENCE BOAT ORDER  
① - COMPANION GARMIN SCREEN - REA23500053723

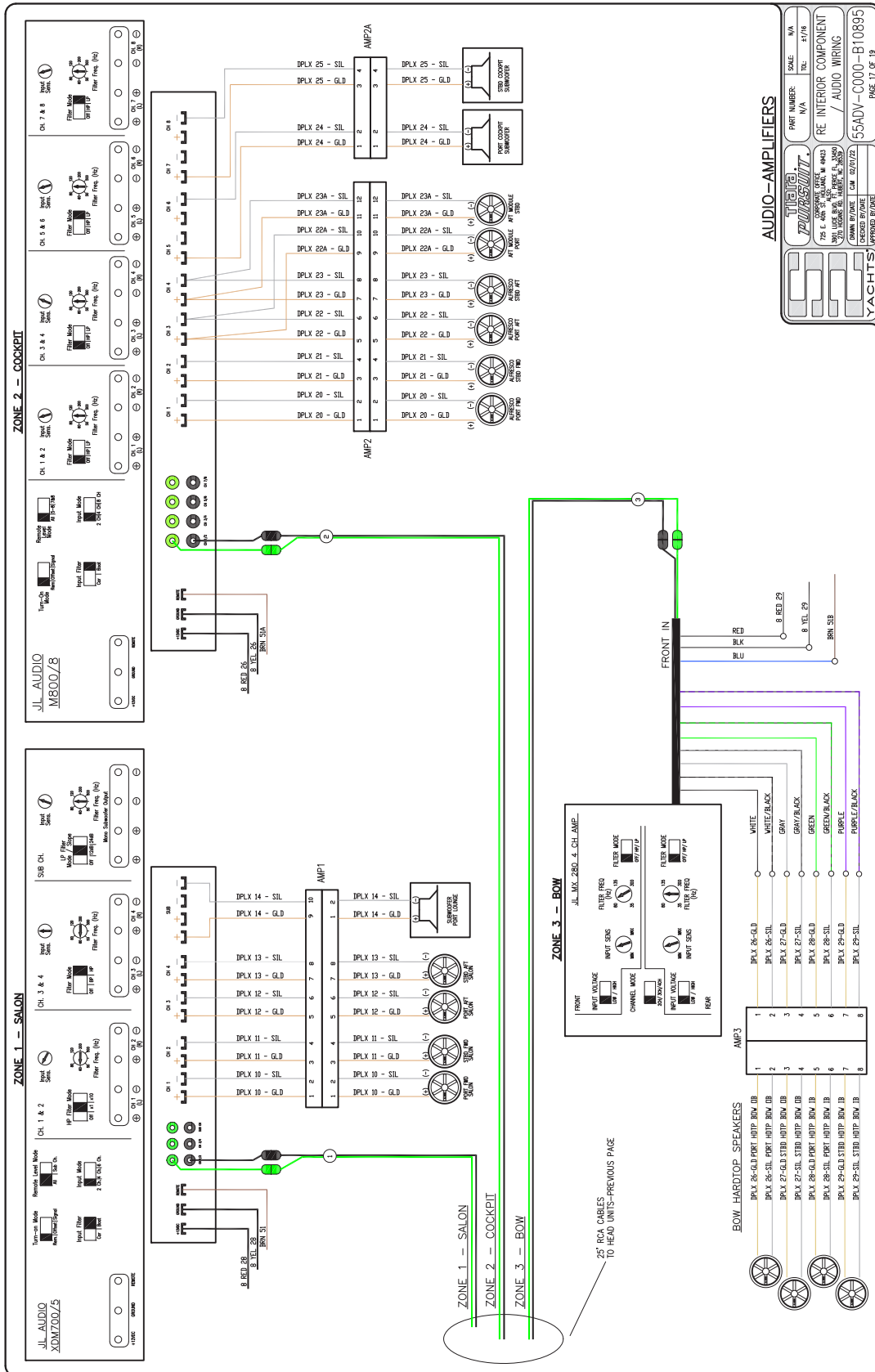



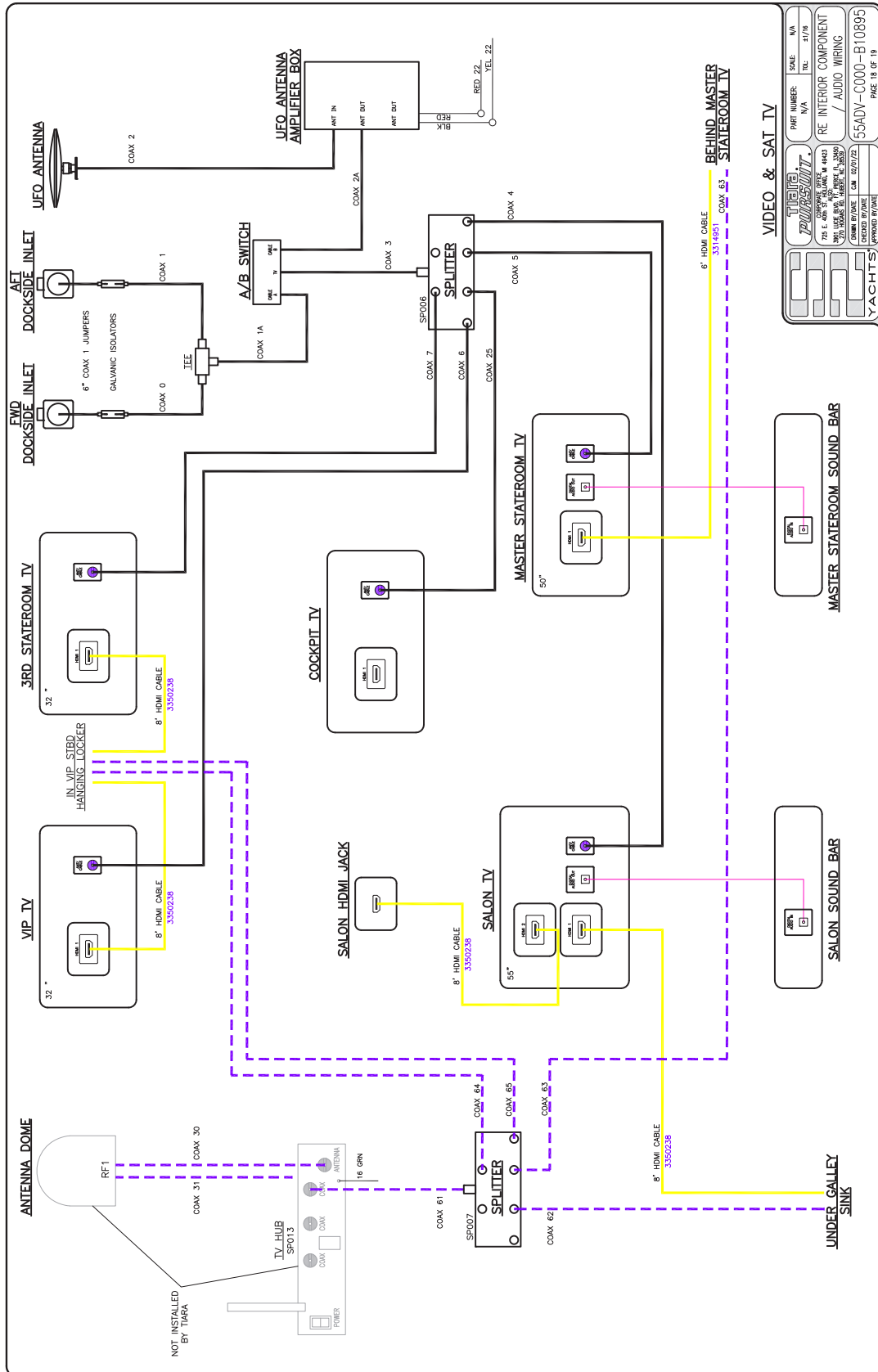

SCALE	N/A
DATE	2/17/18
PART NUMBER	N/A
REVISION	1
RE INTERIOR COMPONENT / AUDIO WIRING	
DATE	02/07/18
BY	CM
APPROVED BY	CM
55ADV-C000-B10895	
PAGE 18 OF 19	



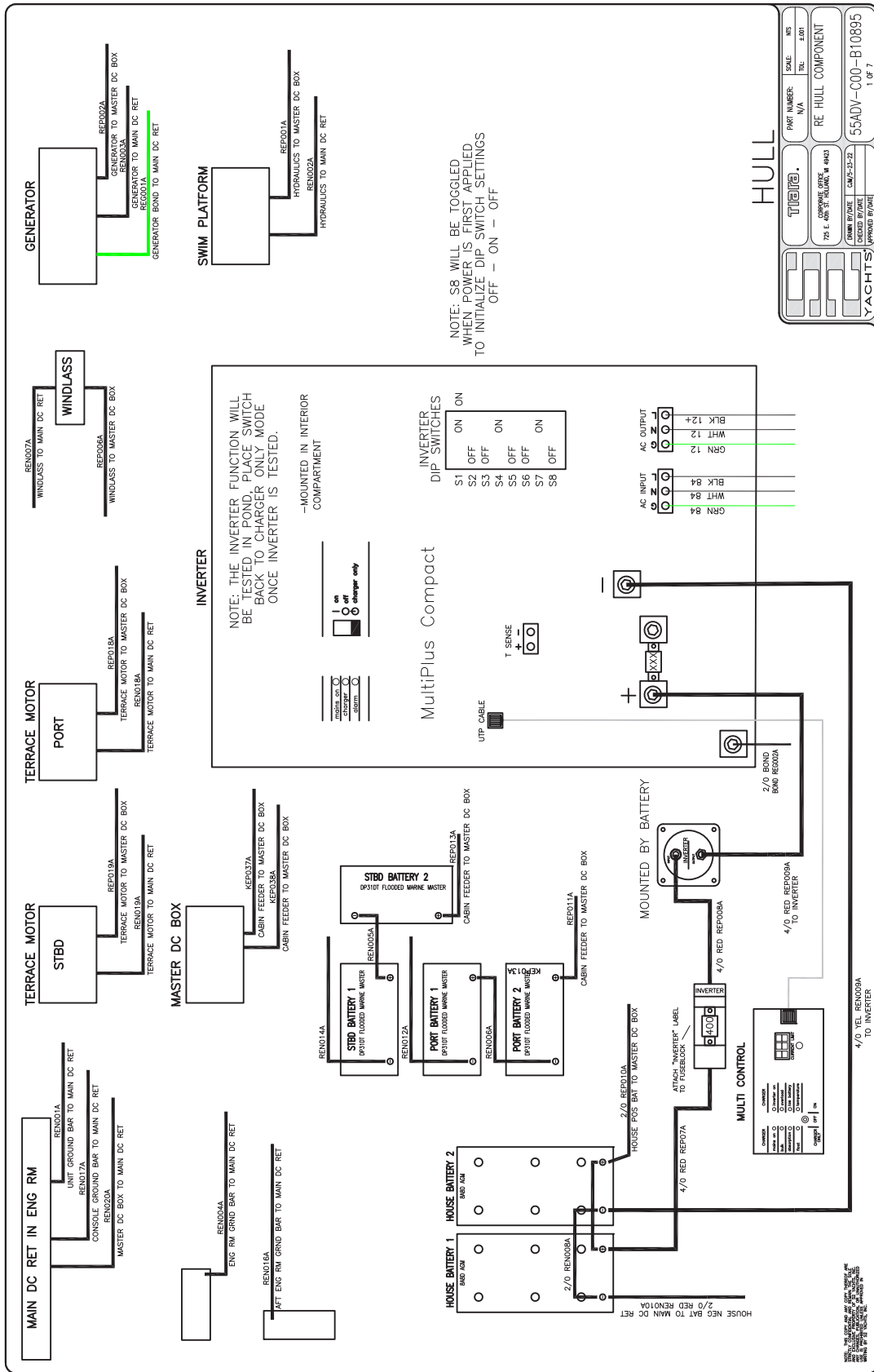

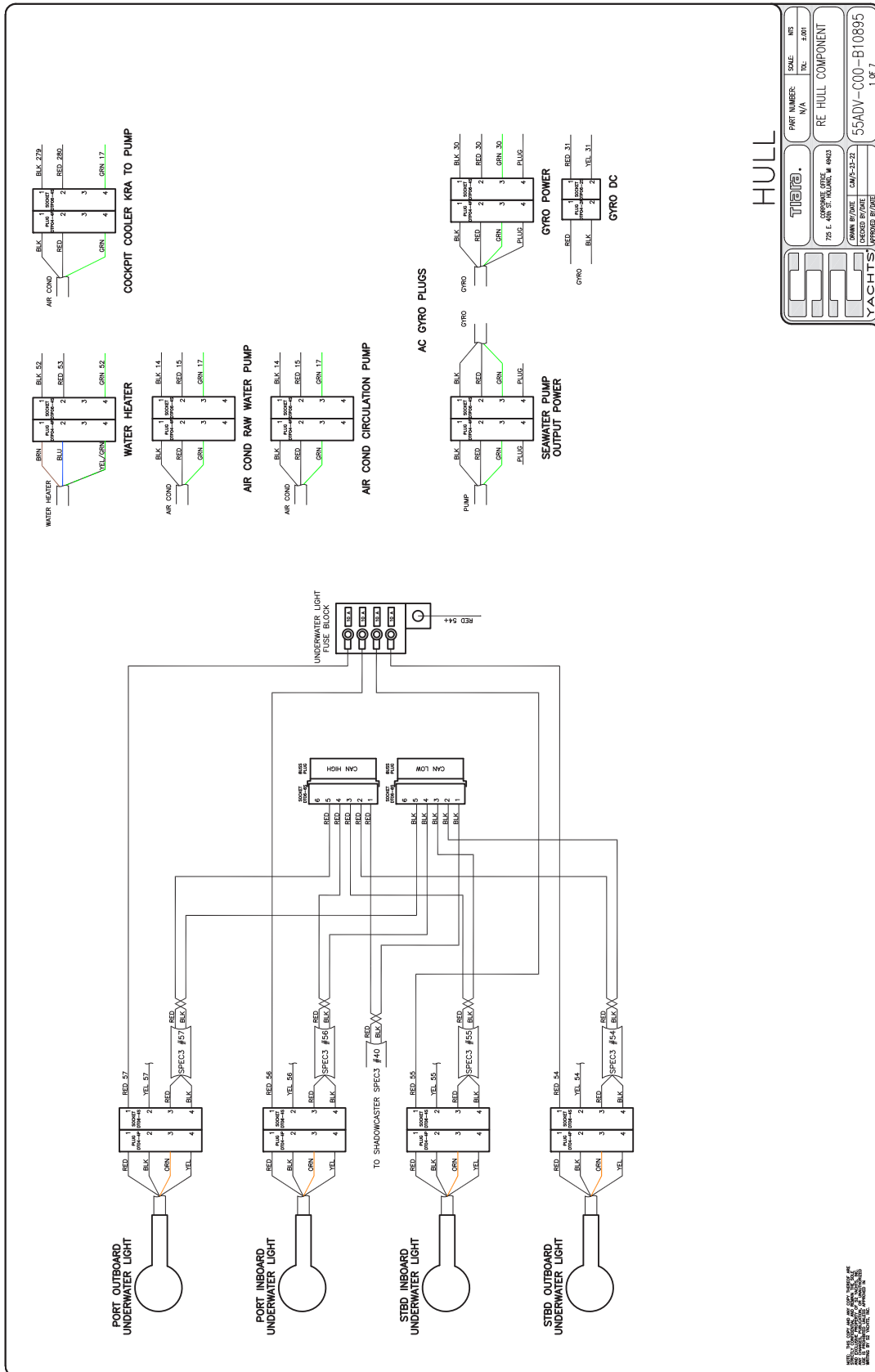

HULL

PART NUMBER: N/A		SCALE: N/A	REV: #001
COMPONENT: RE HULL COMPONENT		DATE: 08/15/2021	
DRAWN BY: [Signature]		CHECKED BY: [Signature]	
PART NUMBER: 55ADV-C00-B10895		REV: 1 OF 7	

THIS DOCUMENT IS THE PROPERTY OF TIARA YACHTS. IT IS TO BE USED ONLY FOR THE PROJECT AND VESSEL FOR WHICH IT WAS PREPARED. IT IS NOT TO BE REPRODUCED OR TRANSMITTED IN ANY FORM OR BY ANY MEANS, ELECTRONIC OR MECHANICAL, INCLUDING PHOTOCOPYING, RECORDING, OR BY ANY INFORMATION STORAGE AND RETRIEVAL SYSTEM, WITHOUT THE WRITTEN PERMISSION OF TIARA YACHTS.

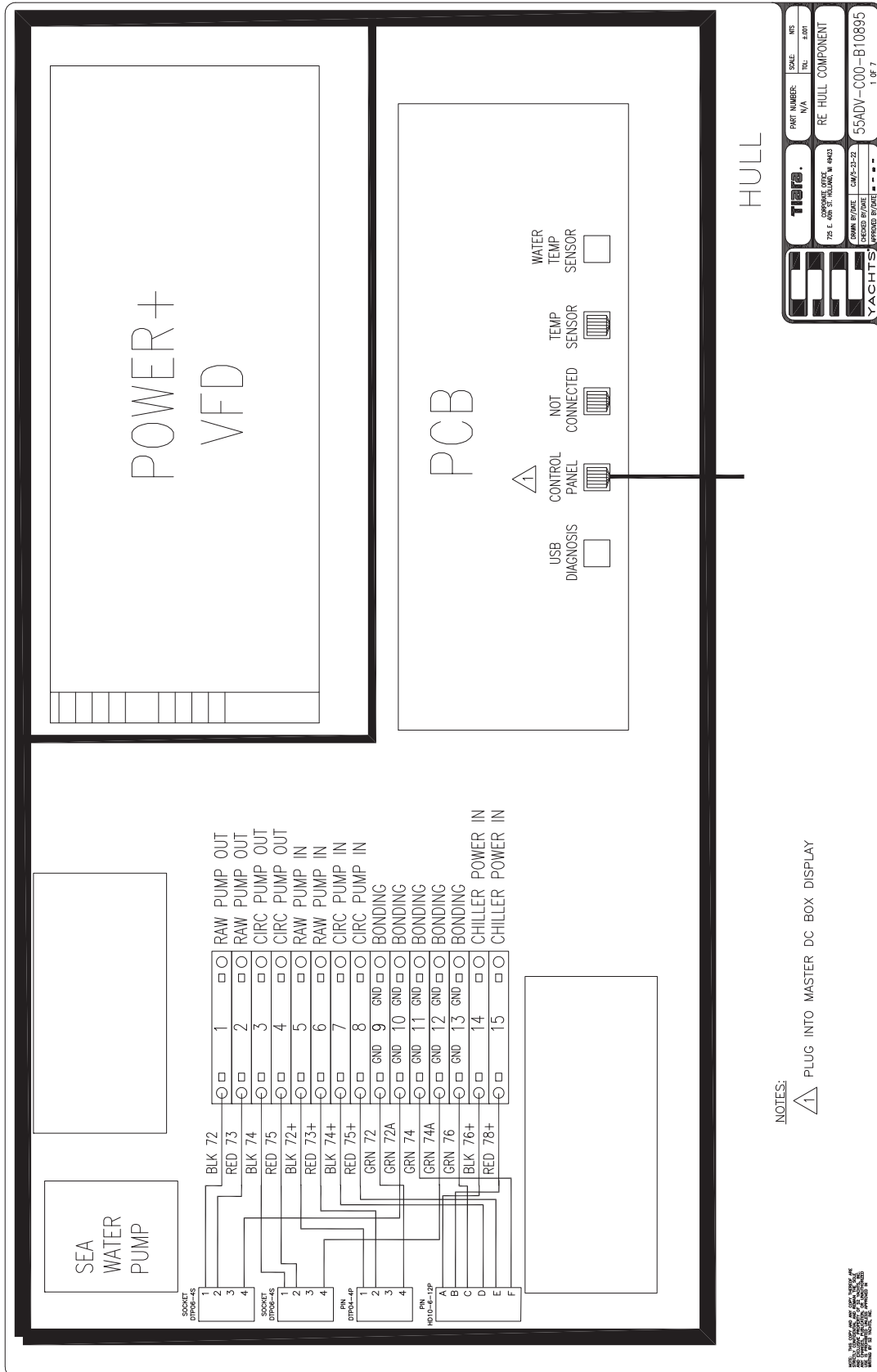

**Tiara**

725 E. 605 ST. TALLAHASSEE, FL 32310

PHONE: 904.863.3322

FAX: 904.863.3322

WWW.TIARA.COM

YACHTS

PART NUMBER: N/A

SCALE: N/A

REV: 001

RE HULL COMPONENT

55ADV-C00-B10895

1 OF 7

KRA-433X UNIT

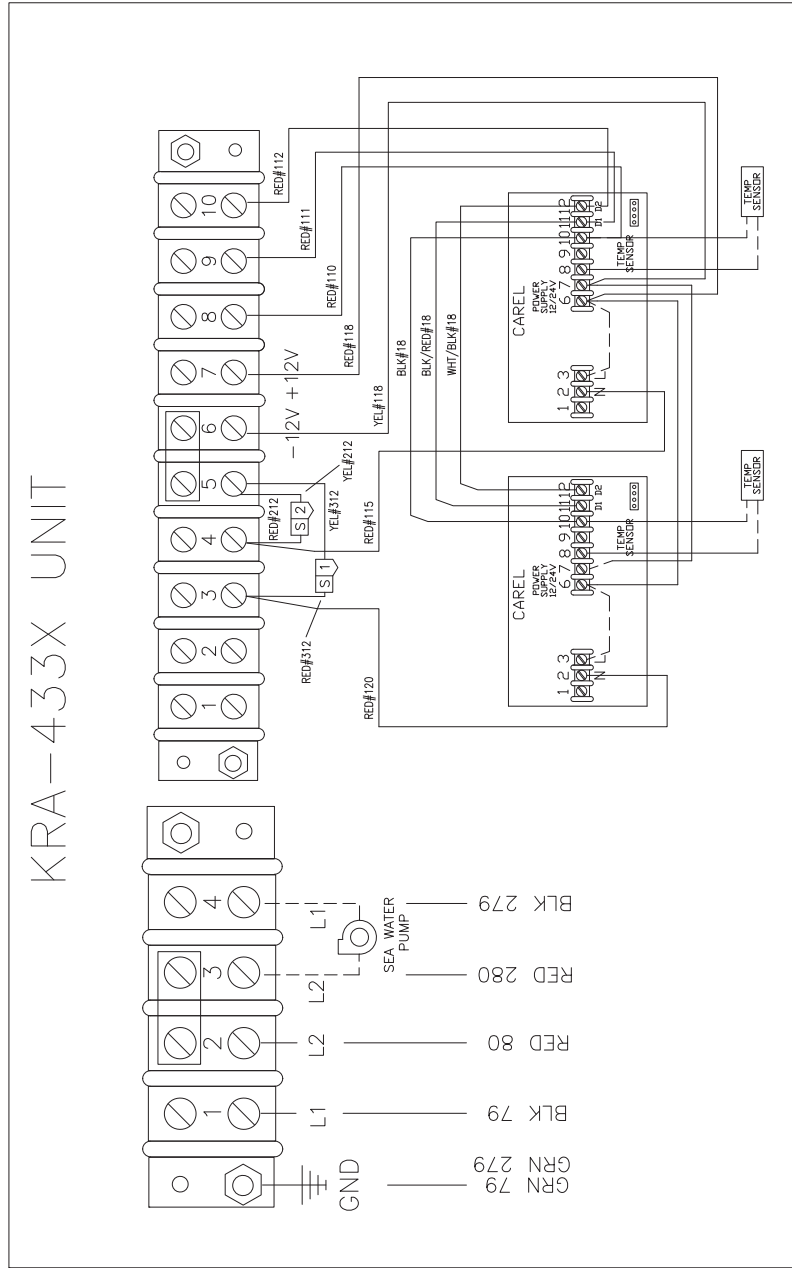

NOTES:

<b>Tiara</b>	PART NUMBER	SCALE	REV
	N/A	1/2"	1.001
	RE HULL COMPONENT		
725 E. 43RD ST. SUITE 400 ANN ARBOR, MI 48103	DATE	DESIGNED BY/DATE	CHECKED BY/DATE
	04/17/2022		
YACHTS		55ADV-C00-B10895	1 OF 7

REVISIONS

INSTALL THIS PANEL IN THE TOP POSITION OF THE MASTER BOX

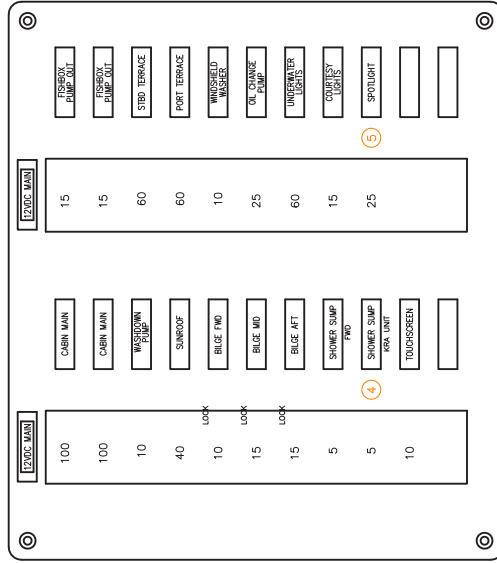
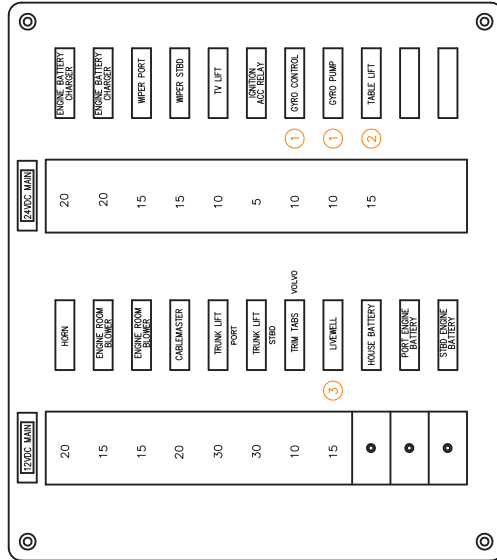

OPTIONAL BREAKERS/COMPONENTS

REFERENCE BOAT ORDER

- ① -- SEAKEEPER 9 GYRO -- REA235000324200
- ② -- BREAKFAST BAR MODULE -- REA23500910629
- ③ -- BAITWELL-ADVENTURE MODULE -- REA23500910643
- ④ -- COILED COOLING SYSTEM W/BAITWELL-ADV -- REA23500910641
- ④ -- ALFRESCO ZONE COILED COOLING SYSTEM -- REA23500910645
- ⑤ -- SPOTLIGHT -- OPTION CURRENTLY UNAVAILABLE

MASTER PANEL LOAD

		PART NUMBER: N/A SCALE: N/A TOL: 1:500
KE PANEL LOAD AND BACKSIDE WIRING		
725 E. 40th St., WILSON, WI 53091		COMPANY PHONE: 414-251-12-22 FAX: 414-251-12-22 APPROVED BY/DATE:
YACHTS		READY-COO-B0897 1 OF 18

© 2018 TIARA YACHTS. ALL RIGHTS RESERVED. THIS DOCUMENT IS THE PROPERTY OF TIARA YACHTS AND IS TO BE USED ONLY FOR THE PURPOSES INDICATED. ANY REPRODUCTION OR DISTRIBUTION OF THIS DOCUMENT WITHOUT THE WRITTEN PERMISSION OF TIARA YACHTS IS STRICTLY PROHIBITED.

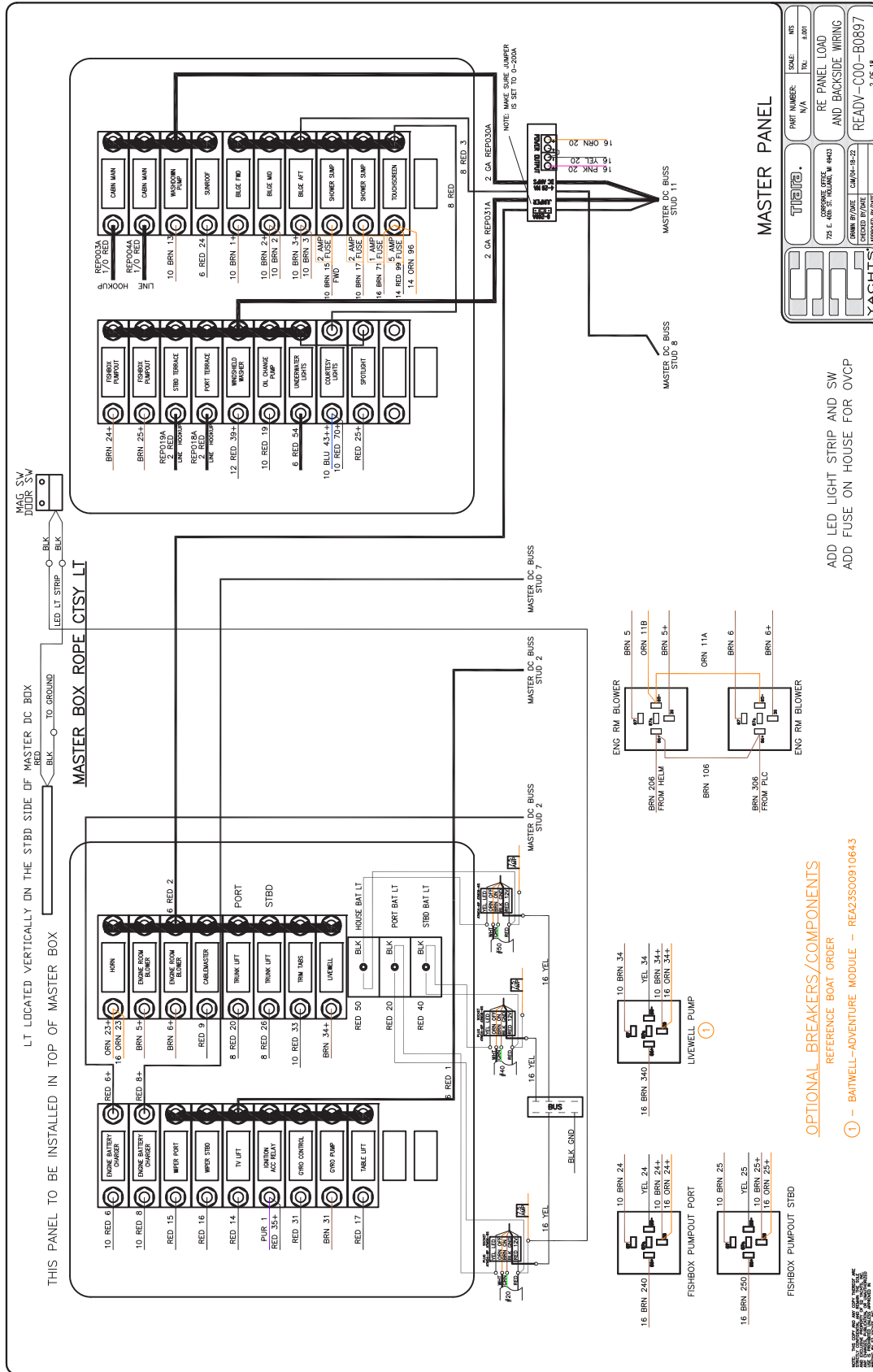



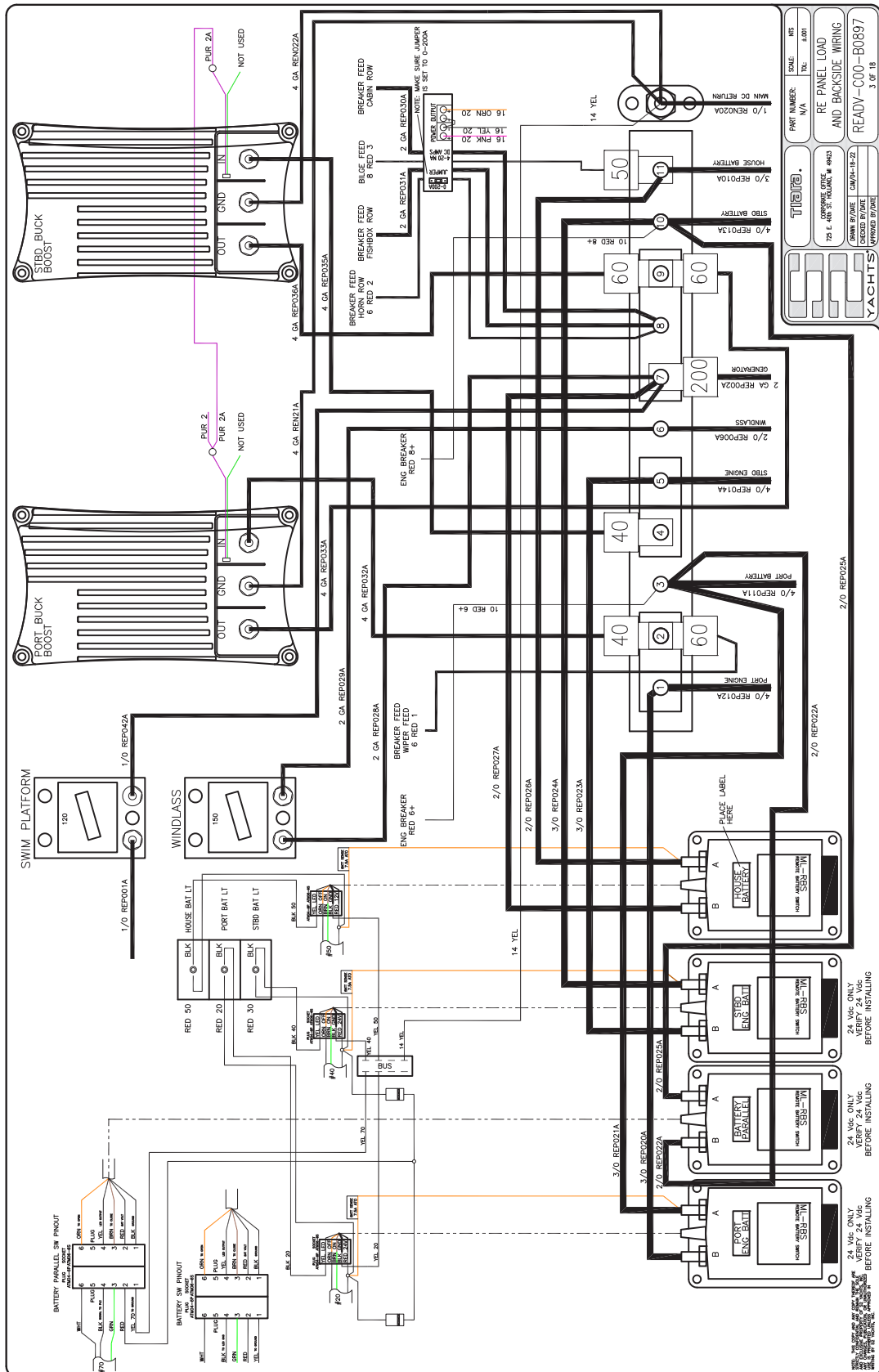

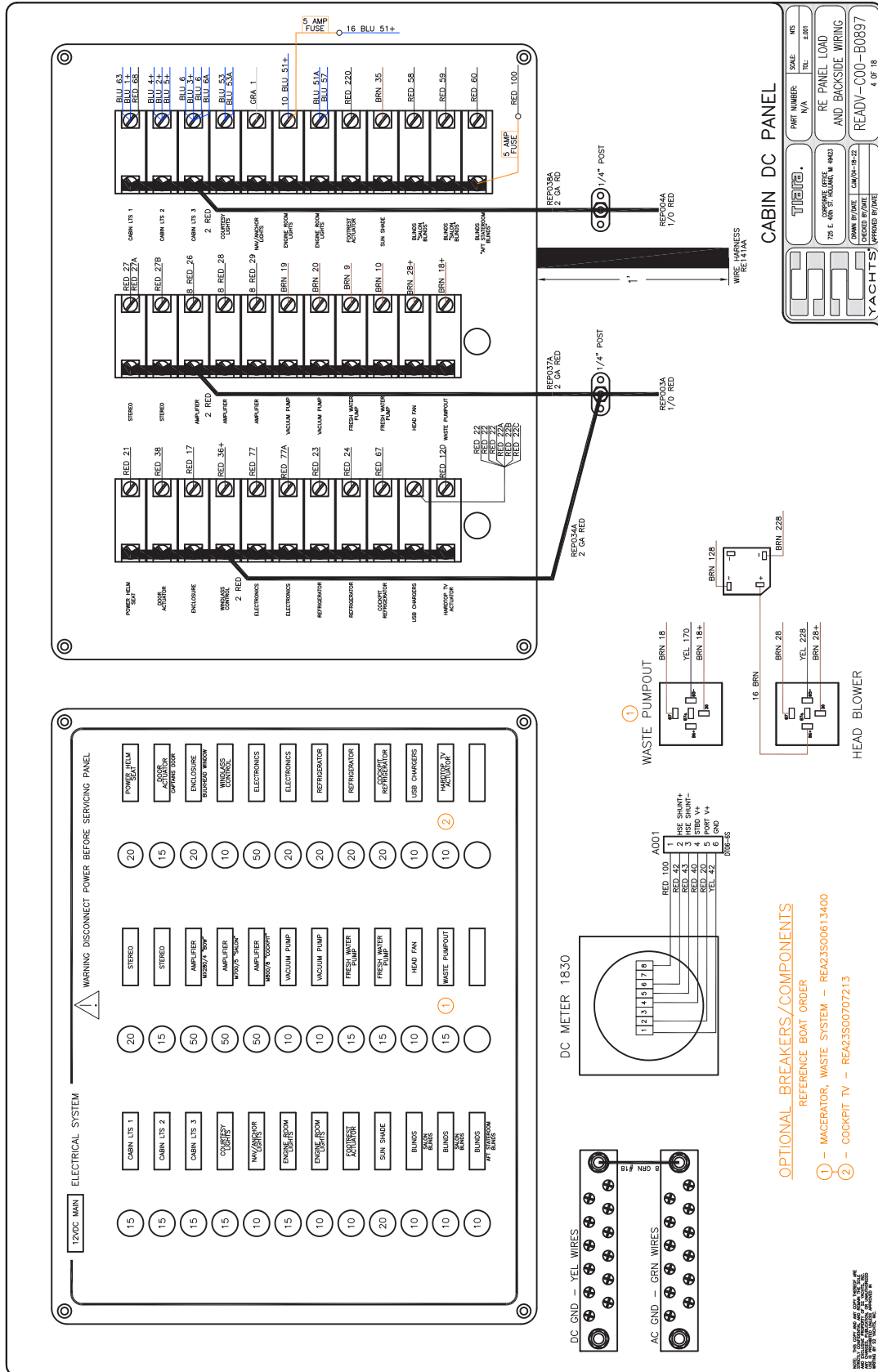

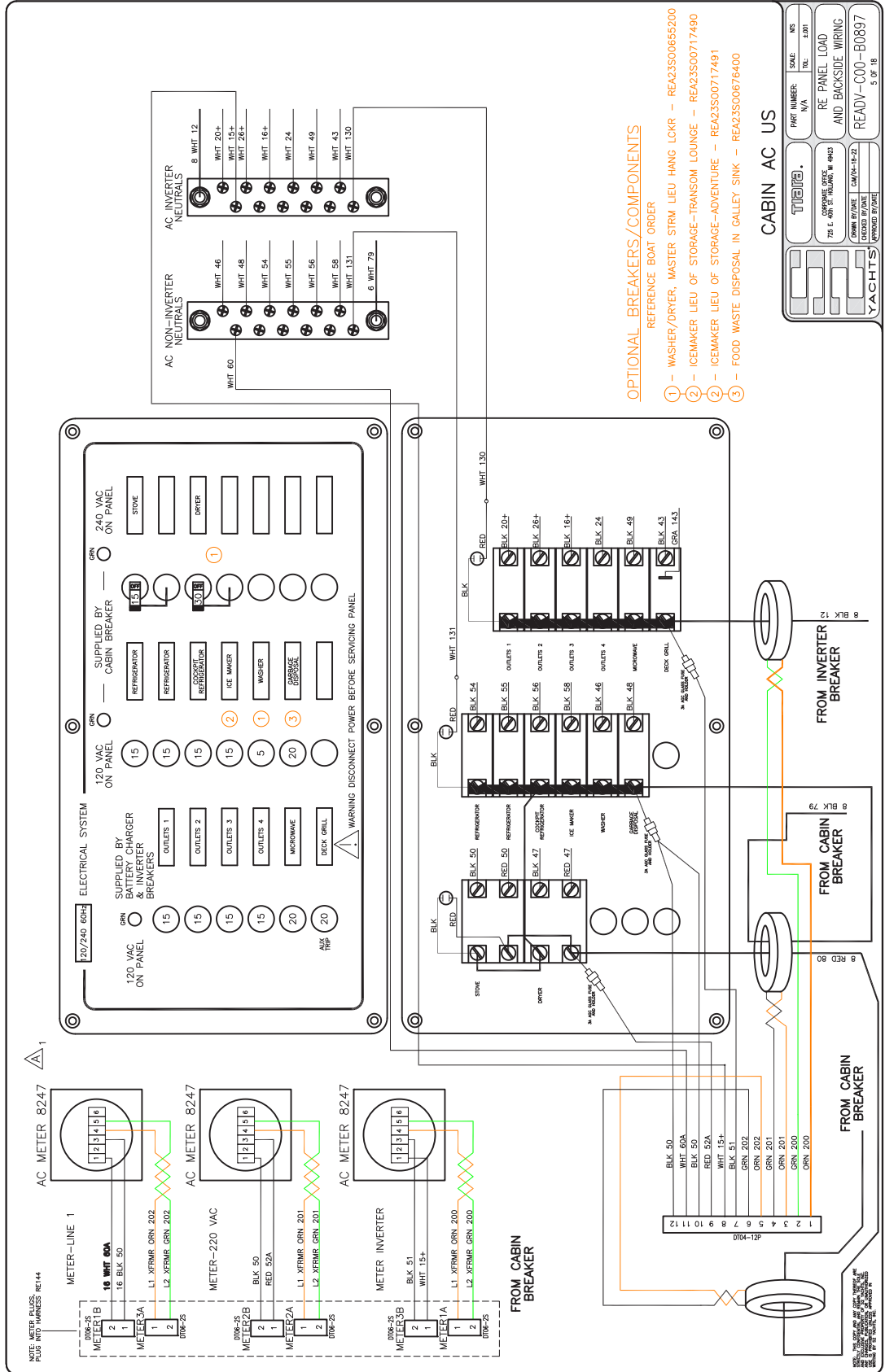

- OPTIONAL BREAKERS/COMPONENTS**  
 REFERENCE BOAT ORDER
- ① - WASHER/DRYER, MASTER STRM LIU HANG LCKR - REA23S0065200
  - ② - ICEMAKER LIU OF STORAGE-TRANSOM LOUNGE - REA23S00717490
  - ② - ICEMAKER LIU OF STORAGE-ADVENTURE - REA23S00717491
  - ③ - FOOD WASTE DISPOSAL IN GALLEY SINK - REA23S00676400

**CABIN AC US**

<b>TIARA</b>	PART NUMBER: N/A	SCALE: 1:00
705 E. 40th St., Holland, MI 49423	RE PANEL LOAD AND BACKSIDE WIRING	
CREATED BY/AE: LCM/PA-19-25	YACHTS	READY-C00-B0897
CHECKED BY/AE:		5 OF 18
VERSION 07/AE:		

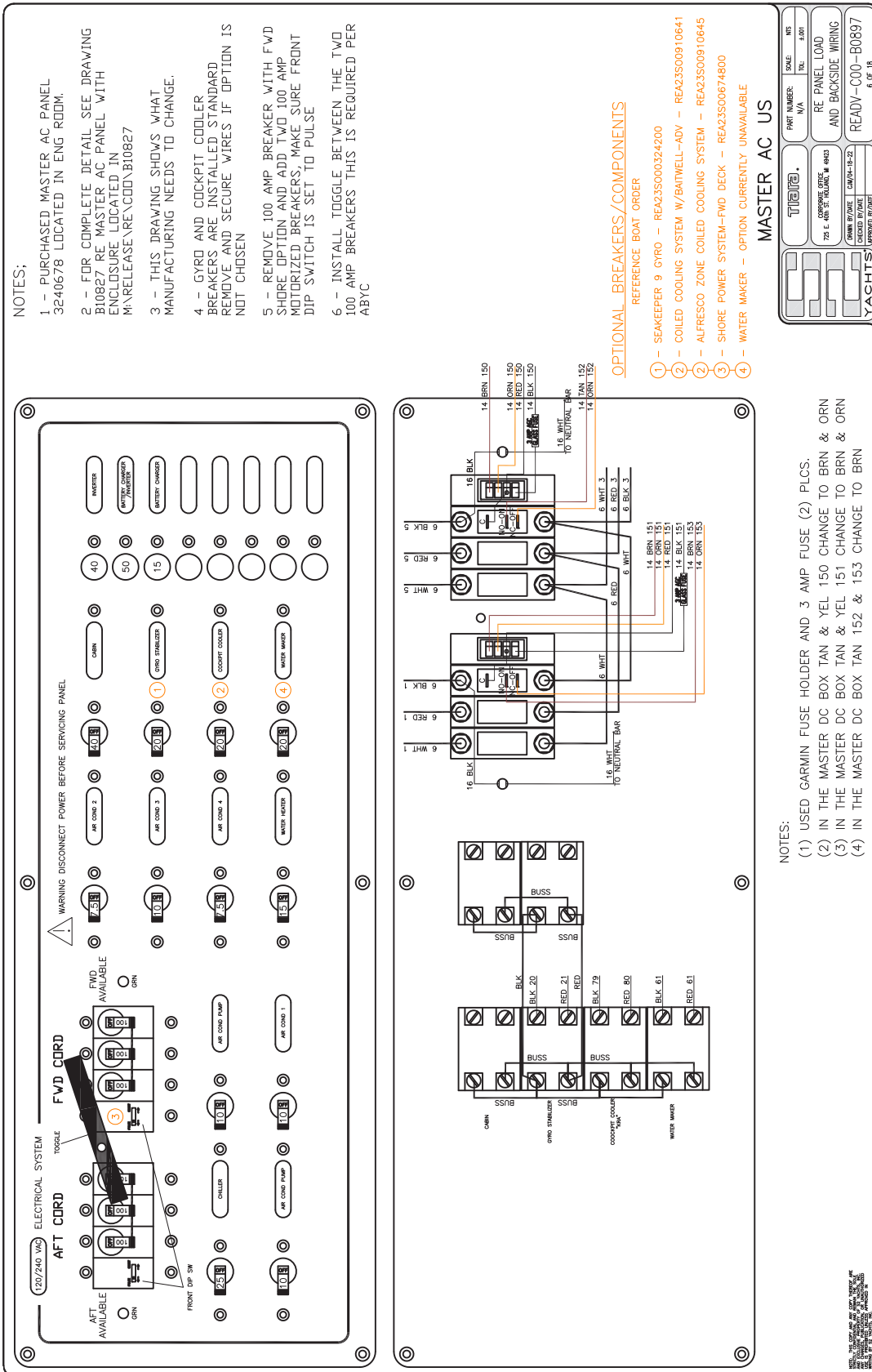

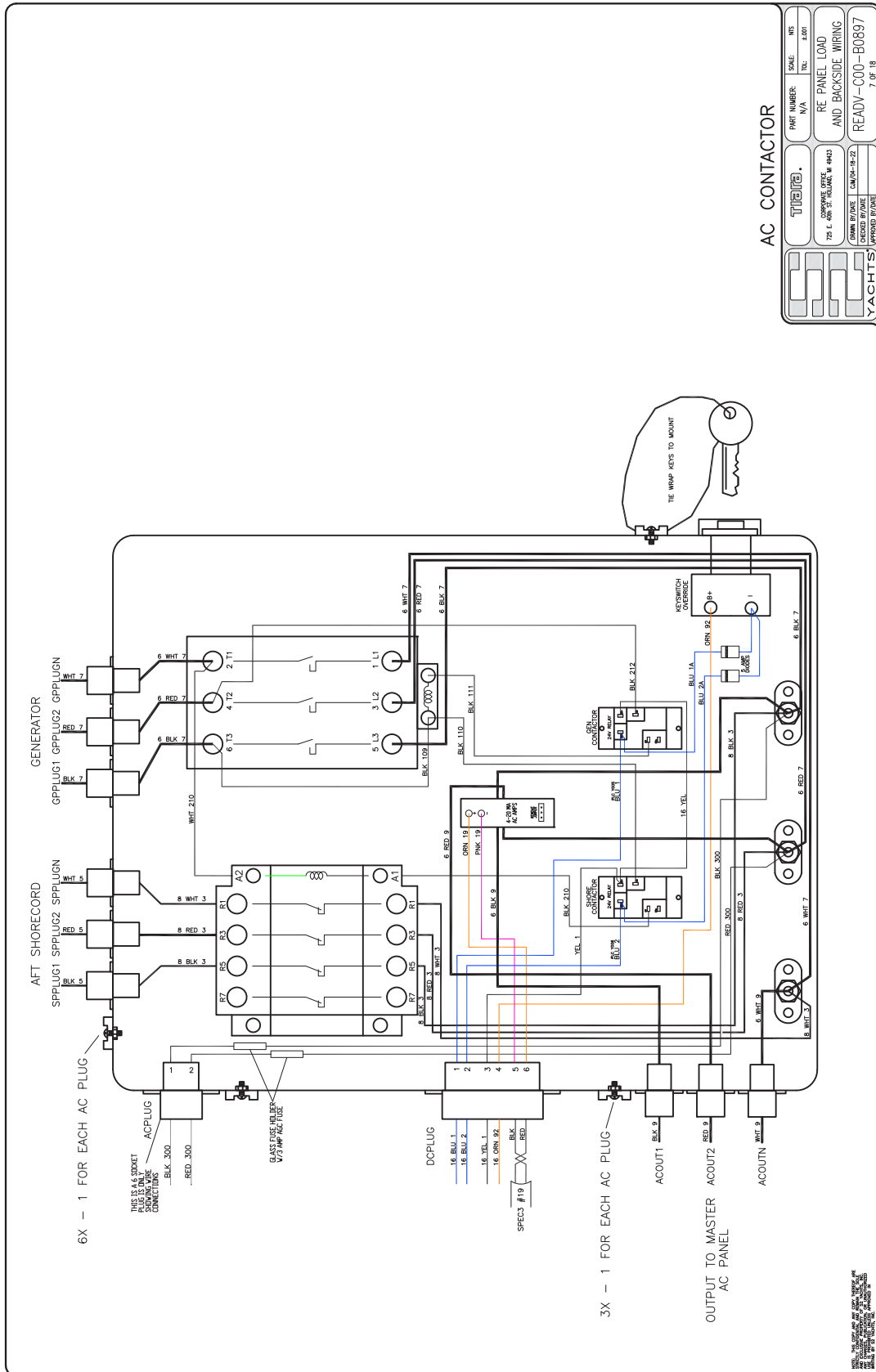

AC CONTACTOR

YACHTS	
PART NUMBER: N/A SCALE: N/A TITLE: RE PANEL LOAD AND BACKSIDE WIRING DRAWN BY/DATE: CM/04-18-22 CHECKED BY/DATE: [Blank] REVISIONS: [Blank]	NO. 18001 READY-COO-B0897 2 OF 18

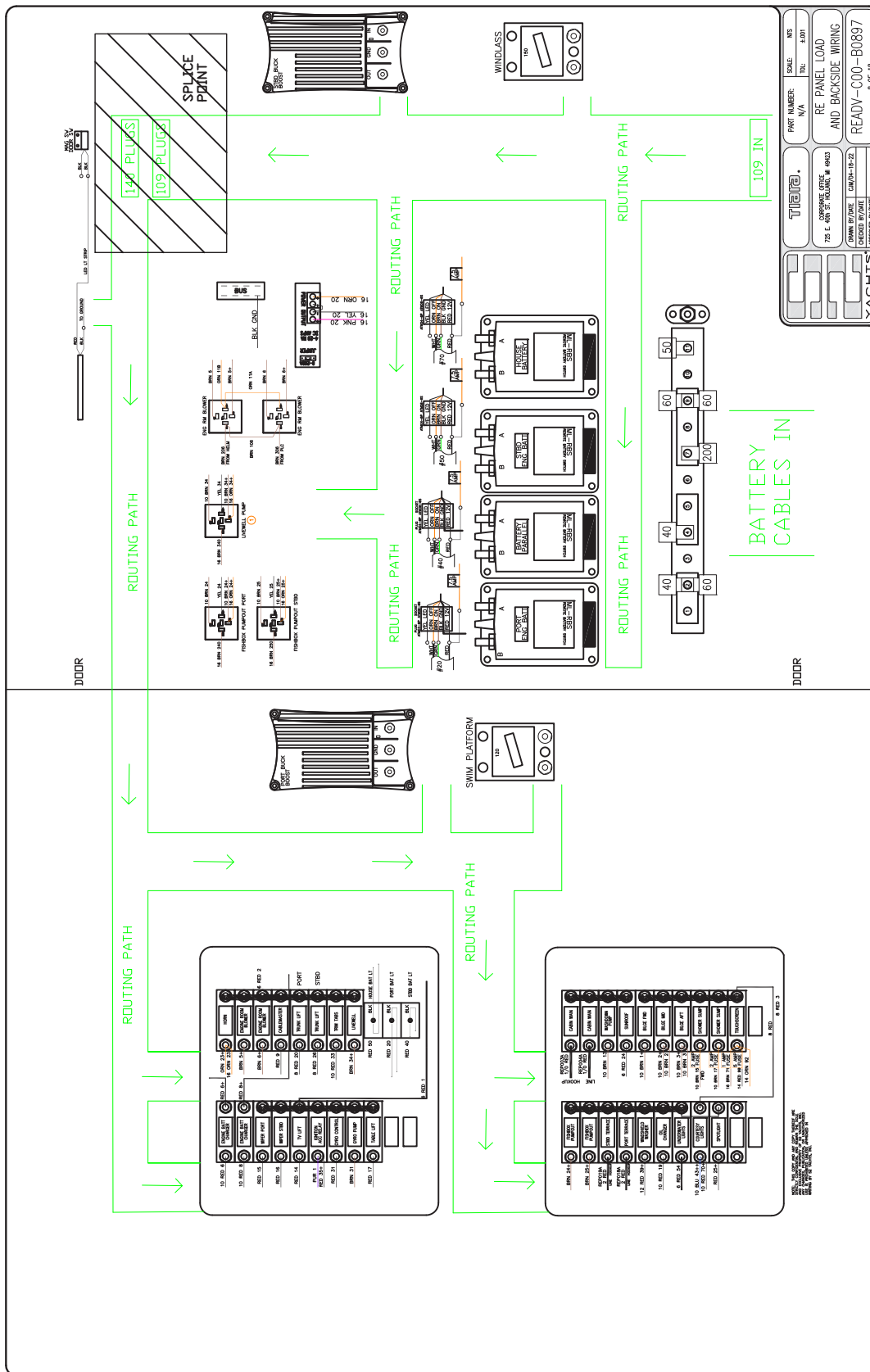

	PROJ NUMBER:	SCALE:	WKS:
	REVISION:	DATE:	DATE:
	RE PANEL LOAD AND BACKSIDE WIRING		
	COMPANY OFFICE # 4903		
	700 E. 40th St. TOLSON, IL 61803		
DRAWN BY/DATE: CAY/04-19-22		CHECKED BY/DATE:	
APPROVED BY/DATE:		APPROVED BY/DATE:	
<b>YACHTS</b> READY-C00-B0897 8 OF 18			

- UPDATES TO DO
- CHANGE 18 RED 100+ PLUG1 LOCATION 1 TO 16 RED 99
  - CHANGE 18 RED 100+ PLUG1 LOCATION 5 TO 16 YEL 99
  - CHANGE 18 RED 100+ PLUG1 LOCATION 7 TO 16 YEL 170
  - REMOVED BAT PARALLEL ON FOR ACR CHANGE NEEDING ONLY ONE SIGNAL SRG

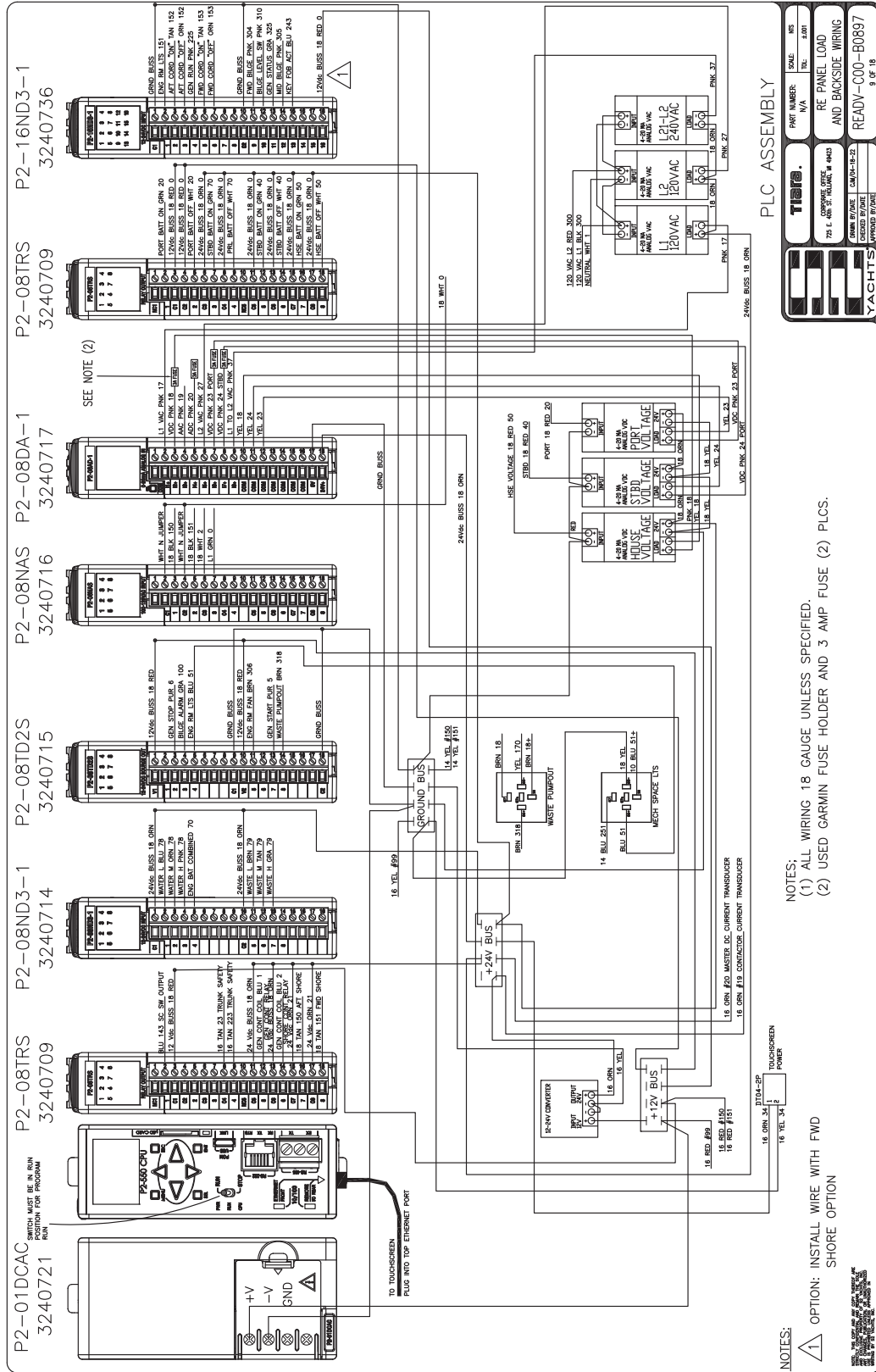

PART NUMBER:		PLC ASSEMBLY
PLC ASSEMBLY		PLC ASSEMBLY
RE PANEL LOAD AND BACKSIDE WIRING		RE PANEL LOAD AND BACKSIDE WIRING
READY-C00-B0897		READY-C00-B0897
9 OF 18		9 OF 18

- NOTES:
- (1) ALL WIRING 18 GAUGE UNLESS SPECIFIED.
  - (2) USED GARMIN FUSE HOLDER AND 3 AMP FUSE (2) PLCs.

- NOTES:
- OPTION: INSTALL WIRE WITH FWD SHORE OPTION





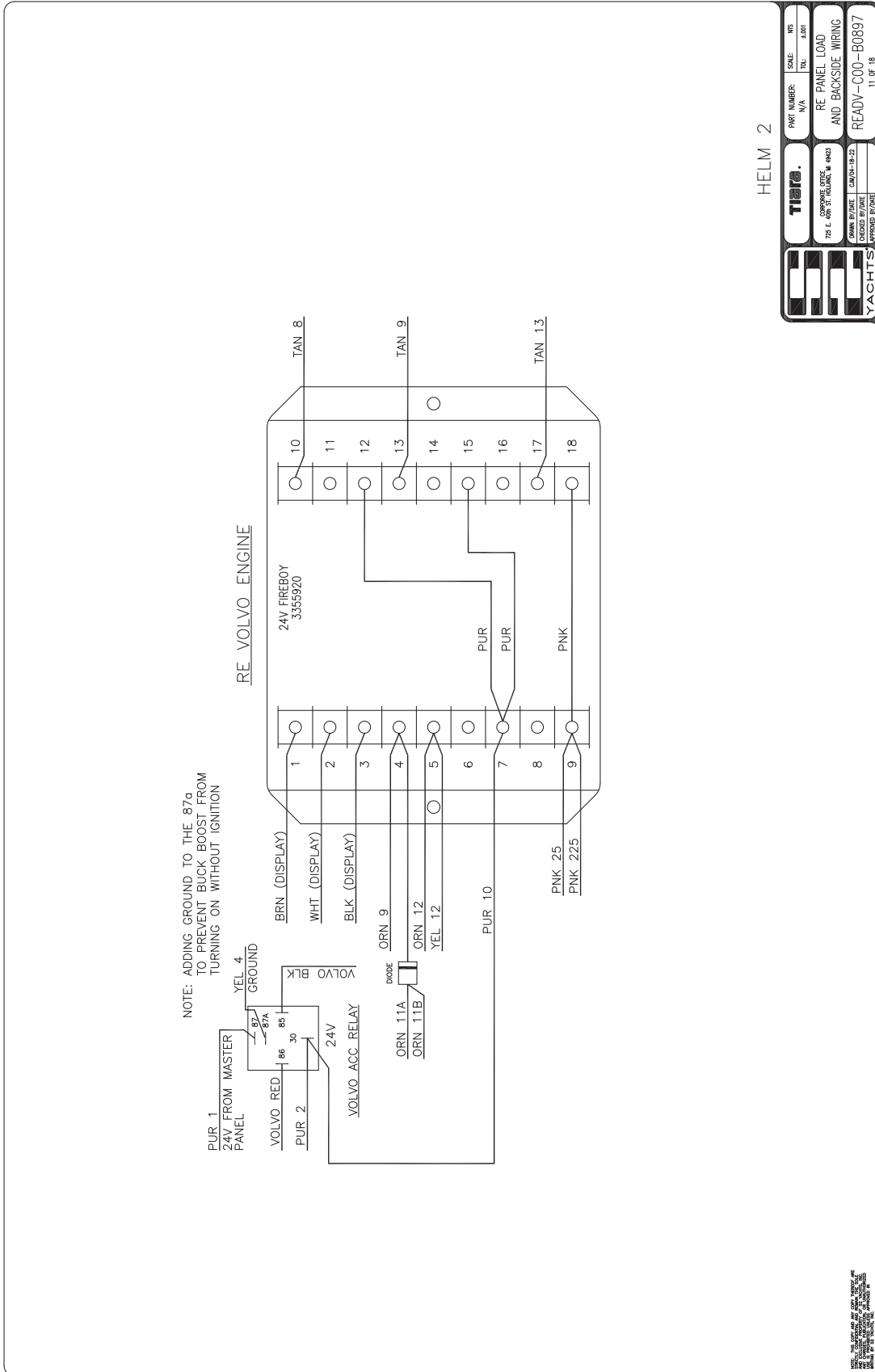

HELM 2

<b>TIARA</b>		PART NUMBER: N/A	SCALE: N/A
725 E. 20th St. Island, WI 54222		RE: PANEL LOAD AND BACKSIDE WIRING	REV: 1.001
DRAWN BY: CM/04-18-22		READY-TOO-B0897	11 OF 19
CHECKED BY: KENNEDY 07/24/22			
YACHTS			

TIARA YACHTS  
725 E. 20th St.  
Island, WI 54222  
TEL: 920.865.8888  
WWW.TIARAYACHTS.COM

**SET UP SHADOW CASTER TO GARMIN "ONEHELM"**

- SELECT GARMIN.
- SELECT 5 ZONES.
- TAP NEXT ARROW UNTIL SCREEN SAYS "LIGHT CONFIGURATION."
- SCREEN WITH LIGHT CONFIGURATION WILL APPEAR, TAP ON ARROW TO NEXT PAGE.
- SELECT OPERATION MODE SCREEN, SELECT FULL OPTION, TAP NEXT.
- UNDER WATER LIGHTS "SCR" WILL APPEAR, TAP NEXT UNTIL SCREEN SAYS "YOUR SYSTEM IS NOW READY TO BE USED"
- ON HOME PAGE, TAP ON "CONFIG"
- TAP ON DEVICES CONFIG, THERE WILL BE 10 DEVICES. 6 FOR U/W LIGHTS AND 4 ON THE DECK.
- PAGES 1-3 SELECT ZONE 5, 4 SELECT ZONE 1, 5 SELECT ZONE 2, 6 SELECT ZONE 3, 7 SELECT ZONE 4, 8-10 SELECT ZONE 5. TAP SAVE ONCE COMPLETE.
- NAME ALL ZONE BY TAPPING ON DEVICE NAME ON EACH PAGE. SAVE EACH TIME BEFORE GOING ON TO NEXT PAGE.
- ONCE ALL ZONES ARE NAMED, SHADOW CASTER PROGRAMMING IS COMPLETE.

**SHADOW CASTER ZONES**

- ZONE 1 = BOARDING Z
- ZONE 2 = HELM LT
- ZONE 3 = AFT LOUNGE
- ZONE 4 = BOW LT
- ZONE 5 = U/W LIGHTS

SC-NET NMEA2000 ETHERNET

CHANNEL 1 CHANNEL 2 CHANNEL 3 CHANNEL 4

**SHADOW CASTER ZONES**

- ZONE 1 = BOARDING Z
- ZONE 2 = HELM LT
- ZONE 3 = AFT LOUNGE
- ZONE 4 = BOW LT
- ZONE 5 = U/W LIGHTS

**ZONE 1 BOARDING ZONE**

PAIR #	PAIR	PAIR #	PAIR
1	RED 43+	1	RED CHANNEL 3
2	GRN 43+	2	GREEN CHANNEL 3
3	RED 44	3	RED CHANNEL 4
4	GRN 44	4	GREEN CHANNEL 4
5	RED 46	5	RED CHANNEL 2
6	GRN 46	6	GREEN CHANNEL 2
7	RED 46	7	RED CHANNEL 1
8	GRN 46	8	GREEN CHANNEL 1
9	NOT USED	9	PWR + OUT CHANNEL 2
10	NOT USED	10	PWR + OUT CHANNEL 1
11	WHIT 43+	11	PWR + OUT CHANNEL 3
12	NOT USED	12	PWR + OUT CHANNEL 4

PAIR #	PAIR	PAIR #	PAIR
1	RED 42A	1	RED CHANNEL 3
2	GRN 42A	2	GREEN CHANNEL 3
3	RED 46	3	RED CHANNEL 4
4	GRN 46	4	GREEN CHANNEL 4
5	RED 46	5	RED CHANNEL 2
6	GRN 46	6	GREEN CHANNEL 2
7	RED 46	7	RED CHANNEL 1
8	GRN 46	8	GREEN CHANNEL 1
9	NOT USED	9	PWR + OUT CHANNEL 2
10	NOT USED	10	PWR + OUT CHANNEL 1
11	WHIT 42A	11	PWR + OUT CHANNEL 3
12	NOT USED	12	PWR + OUT CHANNEL 4

PAIR #	PAIR	PAIR #	PAIR
1	FROM PLC BLU 143	1	+ INPUT SW ZONE 1
2	NOT USED	2	+ INPUT SW ZONE 2
3	NOT USED	3	+ INPUT SW ZONE 3
4	NOT USED	4	+ INPUT SW ZONE 4
5	NOT USED	5	+ INPUT SW ZONE 5
6	NOT USED	6	+ INPUT SW ZONE 6
7	NOT USED	7	+ INPUT SW ZONE 7
8	NOT USED	8	+ INPUT SW ZONE 8
9	NOT USED	9	GROUND
10	NOT USED	10	CAN - H (VCL)
11	NOT USED	11	CAN - L (GRN)
12	NOT USED	12	GROUND

**SHADOW CASTER SYSTEM**

**Tiara**  
YACHTS

785 E. 400th Street, #400  
Lakewood, CO 80122  
Phone: 303.973.1234  
Fax: 303.973.1235  
www.tiaryachts.com

PART NUMBER: WVA  
RE: PANEL LOAD AND BACKSIDE WIRING  
READY-C00-B0897  
12 OF 18

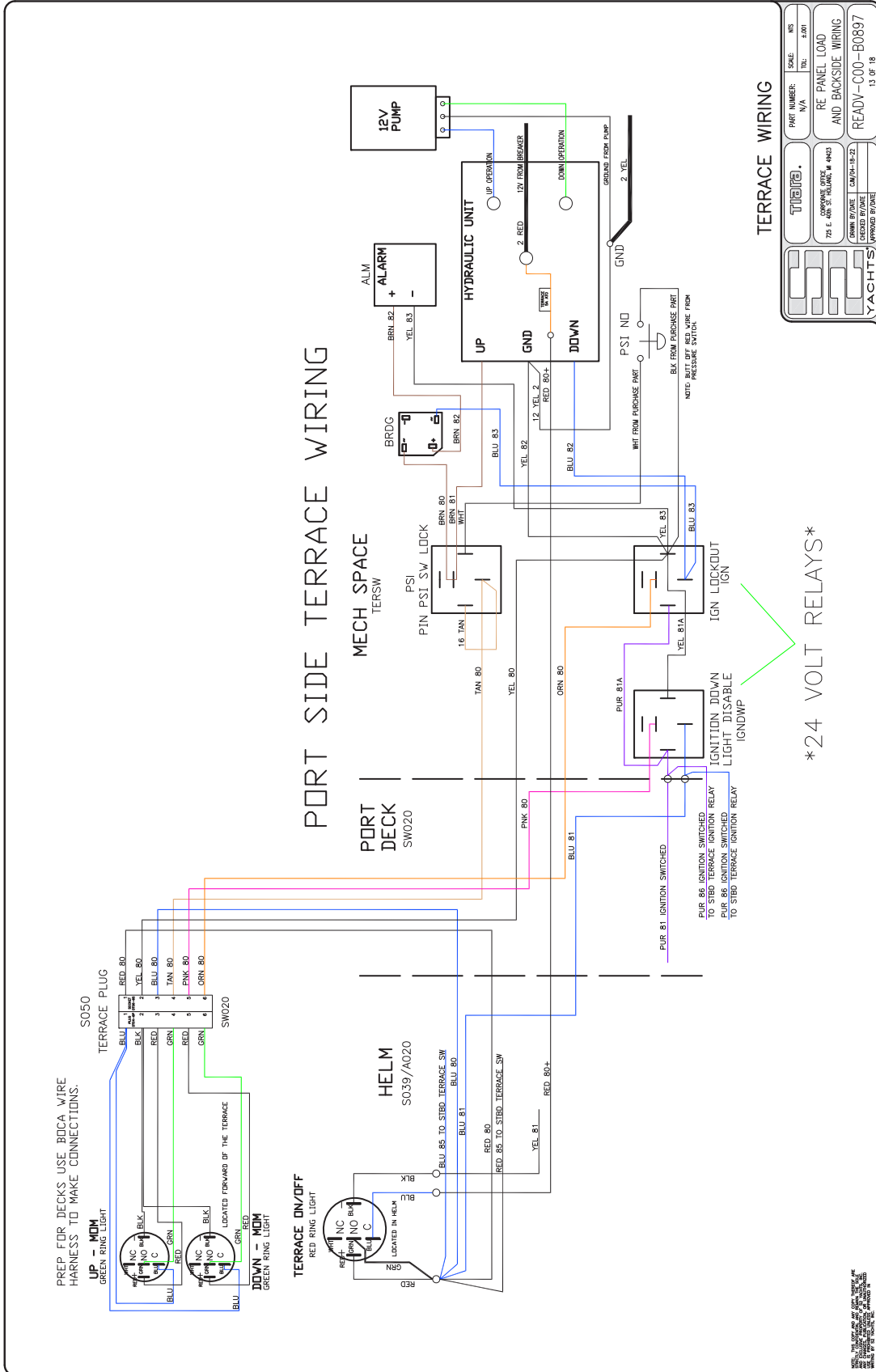

SCALE	MS
PART NUMBER	N/A
REV	4.001
RE PANEL LOAD AND BACKSIDE WIRING	
DATE	7/24/18
BY	CM/18-11-22
CHKD BY	CM/18-11-22
APP'D BY	CM/18-11-22
YACHTS	
READY-COO-B0897	
13 OF 18	

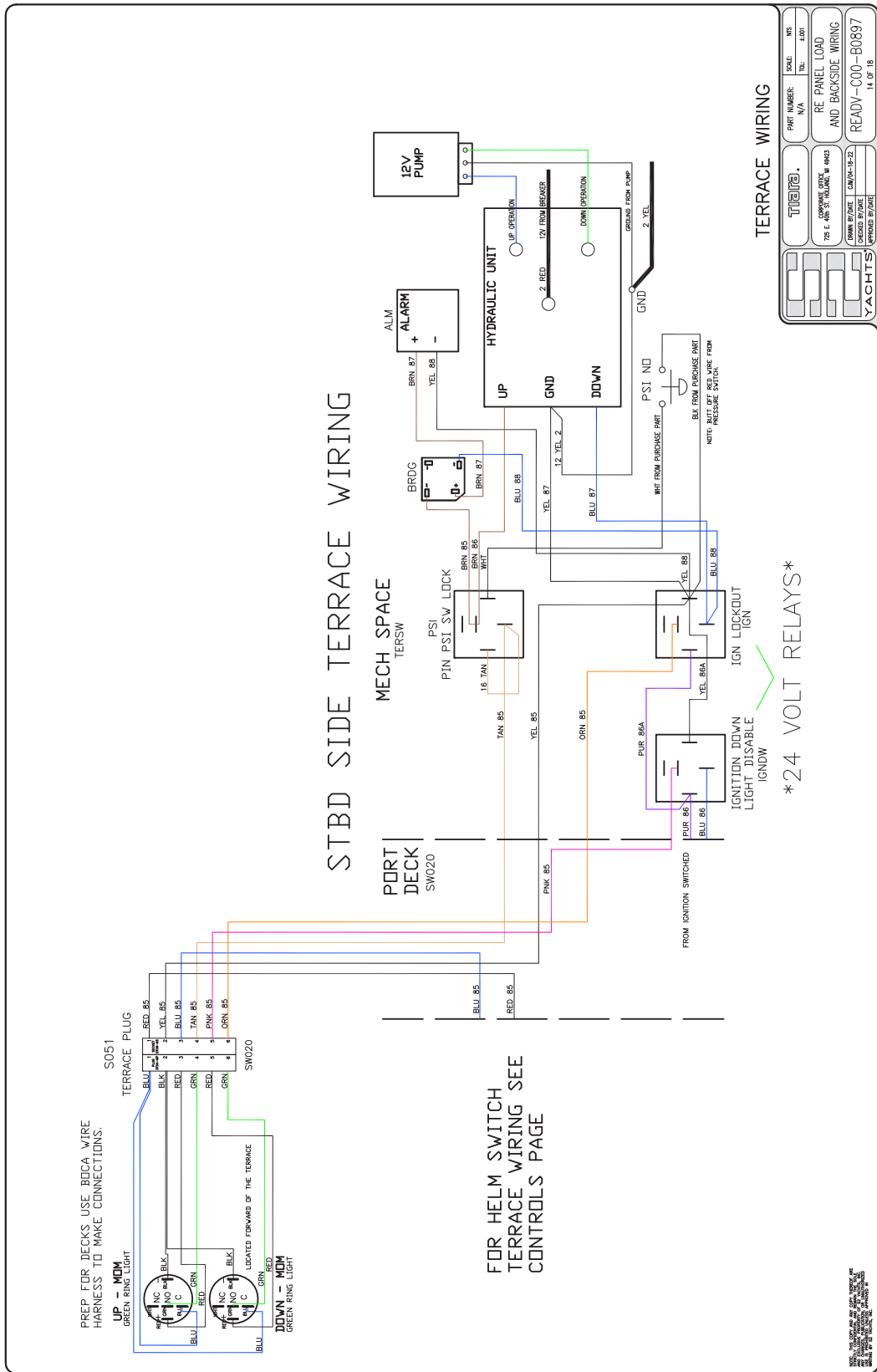

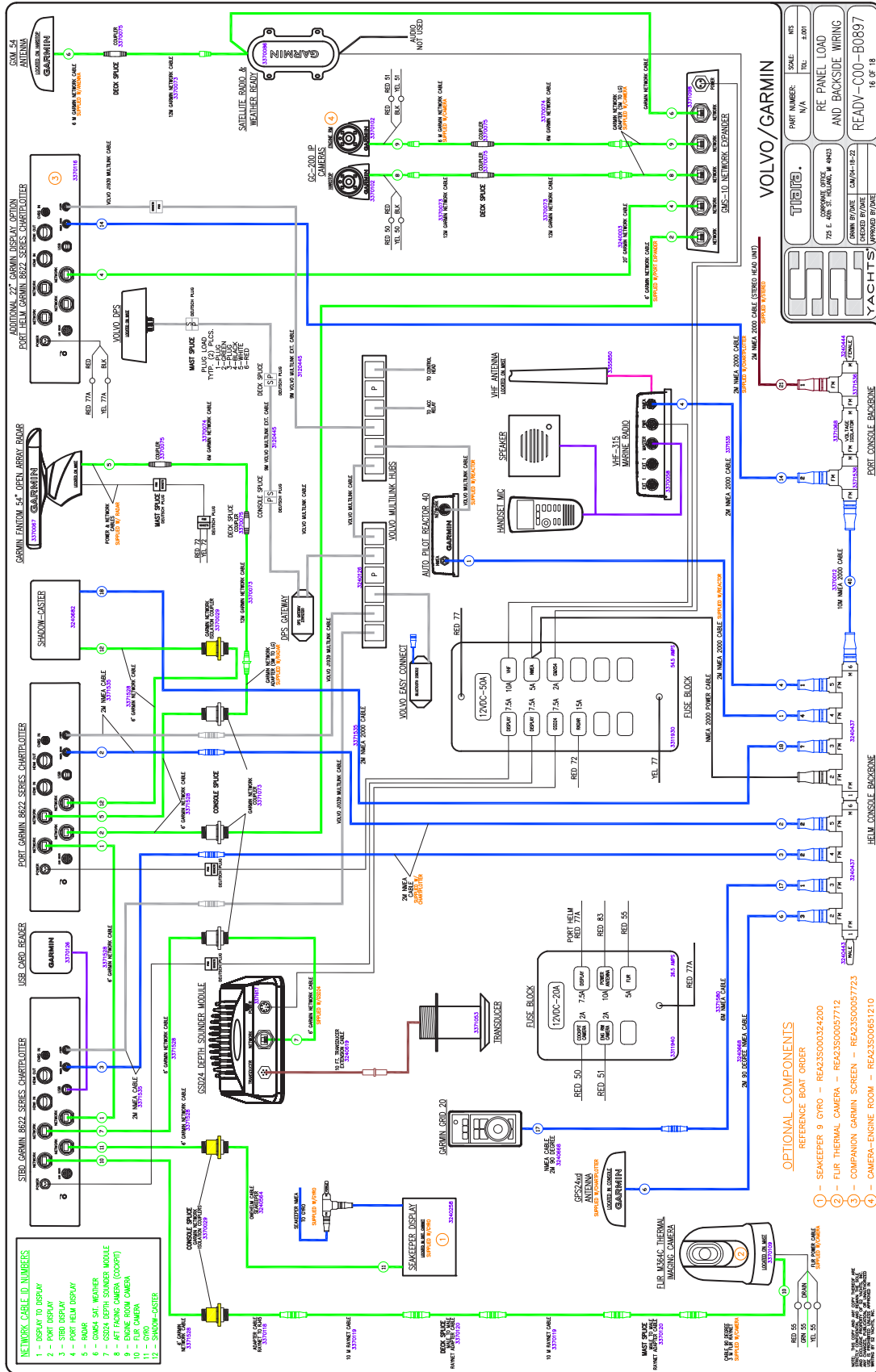

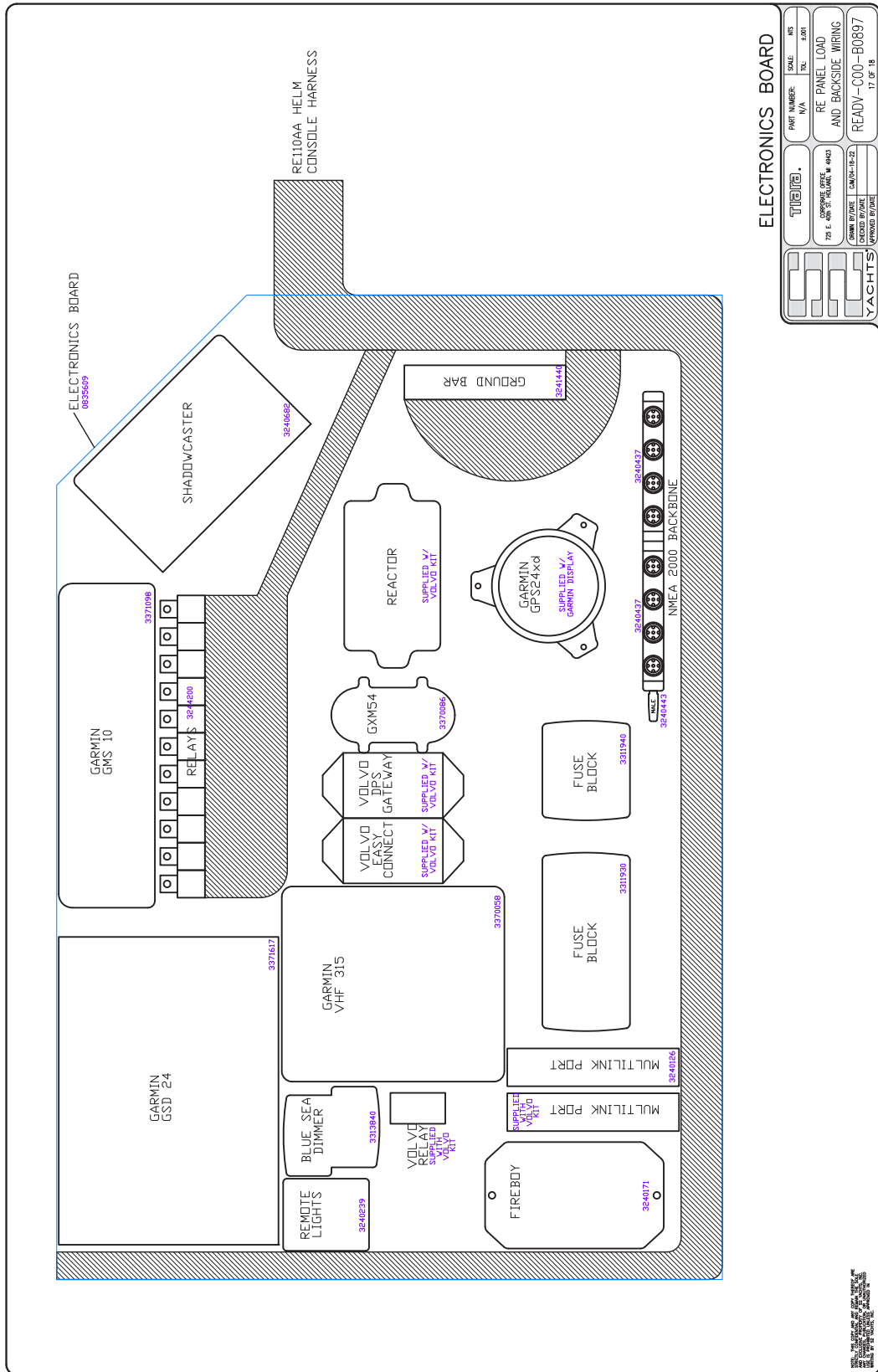

ELECTRONICS BOARD

<b>YACHTS</b>	<b>SCALE</b> N/A	<b>DATE</b> 2001
<b>TIARA</b>	<b>PART NUMBER</b> N/A	<b>REV</b> 1.001
<b>YACHTS</b>	<b>DESIGNED BY/DATE</b> CORPORATE OFFICE 7/21/01	<b>REVISIONS</b> RE PANEL LOAD AND BACKSIDE WIRING
<b>YACHTS</b>	<b>CHECKED BY/DATE</b> C.M. YACHTS	<b>APPROVED BY/DATE</b> READY-C00-B0897

THIS DOCUMENT IS THE PROPERTY OF TIARA YACHTS. IT IS TO BE USED ONLY FOR THE PROJECT AND VESSEL FOR WHICH IT WAS PREPARED. IT IS NOT TO BE REPRODUCED OR TRANSMITTED IN ANY FORM OR BY ANY MEANS, ELECTRONIC OR MECHANICAL, INCLUDING PHOTOCOPYING, RECORDING, OR BY ANY INFORMATION STORAGE AND RETRIEVAL SYSTEM, WITHOUT THE WRITTEN PERMISSION OF TIARA YACHTS.



# **Tiara**<sup>®</sup>

**Y A C H T S**

725 E 40th Street, Holland, MI 49423 | 616.392.7163  
tiarayachts.com



**AMERICAN MADE**