

34LS



Tiara
YACHTS

2025 OWNERS MANUAL

CALIFORNIA PROPOSITION 65 WARNING



WARNING

WARNING: Operating, servicing and maintaining a recreational marine vessel can expose you to chemicals including engine exhaust, carbon monoxide, phthalates, and lead, which are known to the State of California to cause cancer and birth defects or other reproductive harm. To minimize exposure, avoid breathing exhaust, service your vessel in a well-ventilated area and wear gloves or wash your hands frequently when servicing this vessel. For more information go to www.P65warnings.ca.gov/marine.

Per California law, the label below is affixed to your boat's helm console. Should you need a replacement, contact Tiara Yachts customer service and request safety label #5450158.

EMISSIONS CONTROL SYSTEM INFORMATION

MEETS 2025 MY CALIFORNIA EVAP EMISSIONS
REGULATIONS FOR SPARK-IGNITION MARINE WATERCRAFT

MANUFACTURER: **S2 YACHTS, INC.**

CALIFORNIA EVAP FAMILY: **STRAPVSSL001**

EMISSION CONTROL SYSTEM: **CP**

5450158



Welcome to the family of Tiara Yachts boat owners and congratulations on your purchase of your new Tiara Yacht.

We understand there are many choices available to you, and we appreciate the investment that you've made and the subsequent faith and confidence that you've placed into our product. Hopefully, during the selection and buying process, you discovered that each Tiara has been designed, engineered, and built with care and precision.

When our company was started, it was the goal of my father, Leon Slikkers, to provide you with the finest quality boat available. We want to be the best and deliver the best to you. And part of that includes a delightful ownership experience. Everything we have achieved since our humble beginnings has been with this same goal in mind.

The information within this owner's manual was assembled to assist you in understanding how to operate your boat to obtain the maximum enjoyment of your Tiara Yacht. So please take time to read the manual completely and please operate your boat safely and courteously.

I would also like to ask you a personal favor. Shortly, you will receive a survey asking for your opinion about the sales process you experienced when you purchased your boat. Approximately nine months later, you'll be sent another survey inquiring about your ownership experience. By taking a few minutes to complete these surveys, you will be providing us with valuable information.

Best wishes for many happy hours aboard your new Tiara Yacht,

A handwritten signature in blue ink, appearing to read "T. Slikkers", with a long horizontal flourish extending to the right.

Thomas B. Slikkers
CEO/President S2 Yachts

This page intentionally left blank.



LIMITED WARRANTY

2025 MODELS TIARA YACHTS, INC. LIMITED WARRANTY COVERAGE

Tiara Yachts, Inc. (Tiara) provides limited warranty coverage on Tiara Yachts products sold for use by retail (non-commercial) customers, as described in this Limited Warranty. For customers in the U.S.: this warranty gives you specific legal rights; you also may have other rights, which vary from state to state. For customers in the European Union: the purchaser may have additional legal rights under applicable national legislation governing the sale of consumer goods, and those rights (if applicable) are not affected by this warranty.

This warranty is provided only to the original purchaser of the boat from an authorized Tiara Yachts dealer but can be transferred to subsequent owners. Contact Tiara's Customer Relations Department if you need information about transferring this warranty. No warranty coverage is provided to subsequent owners unless they follow Tiara's transfer procedures. This warranty does not extend or apply to anyone else. The terms of this written warranty cannot be changed or modified, except by a written agreement signed by an officer of Tiara Yachts, Inc.

COVERED PRODUCTS AND LIMITATIONS:

Tiara's limited warranty coverage applies only to:

1. Defects in materials and workmanship in the boat and all components and accessories (except for the excluded items described below) for a period of two (2) years;
2. Structural defects in materials and workmanship in the hull and deck for a period of five (5) years;
3. Blistering due to defects in material and workmanship in the gelcoat surface of the hull bottom for a period of five (5) years, provided that the gelcoat surface has not been altered in any way such as sanding, sandblasting or application of a coating other than standard antifouling paint, any of which will void this warranty.

Each of the warranty coverage periods runs from the date of initial delivery of the boat from an authorized Tiara Yachts dealer, and applies only to warranted defects that first manifest themselves and are reported to Tiara within the applicable warranty period. Tiara retains the right to determine to its reasonable satisfaction whether any claimed defect is covered by this warranty.

Certain items are excluded from warranty coverage by Tiara, and this limited warranty coverage does not apply to:

1. Engines, transmissions, generators, air conditioning systems, swim platforms and lifts, seakeeping systems, electronics and batteries, and other components manufactured by other manufacturers. These products may come with separate warranties from their manufacturers; see the Owner Packet for warranty registration requirements and details on these products.
2. Dealer final assembly and pre-delivery commissioning, and dealer installed components.
3. Scratching, chipping, discoloration or flaking of any powder coated or painted surface including engines and hardtop components.
4. Gelcoat stress cracking, chalking, fading or discoloration. This includes bilge gelcoat.
5. Damage caused by accident, wear, storm damage, grounding, towing, commercial use of the boat, or misuse or abuse, or deterioration resulting from normal use (including gaskets, seals, springs, wipers and sealants).
6. Maintenance, adjustments or realignments to any components including latches, hinges, hatches, doors and drive train components.
7. Mold, mildew, upholstery damage or deterioration and cleaning.
8. Damage or deterioration resulting from environmental conditions, including electrolysis, crevice or galvanic corrosion, any deterioration of underwater equipment, or any damage or deterioration resulting from any failure to undertake reasonable, routine maintenance.

9. Any repairs, adjustments, alterations or modifications made by anyone other than an employee of Tiara Yachts, or an authorized Tiara Yachts dealer with Tiara's prior, written authorization.
10. Damage which has occurred as a result of the boat being operated as a demonstrator and/or displayed for sale.
11. Damage or deterioration of the hull or deck structure due to the attachment of hardware or other components.
12. Weight, speed, fuel consumption or other performance characteristics.
13. Damage or deterioration resulting from improper trailering, hauling, launching or storage.
14. Boats purchased or used for commercial or governmental purposes or uses.

REMEDIES UNDER THIS LIMITED WARRANTY

If a defect covered by this warranty occurs, Tiara (or one of its authorized dealers, as determined by Tiara) will repair and replace the defective component, in its sole discretion. This 'repair or replacement' remedy is the exclusive remedy under this warranty. The dealer or service facility providing any such repairs is solely responsible for (and warrants) its workmanship in performing that work. Tiara has no responsibility or liability for any consequential or incidental damages, such as loss of use, storage charges, interest or finance charges, insurance or depreciation, transportation or lodging charges, or charges for towing or hauling out, etc. which are specifically excluded and disclaimed from this warranty. Service provided under this warranty does not extend or toll the applicable warranty coverage period(s) or requirements, unless otherwise required by law. For customers in the U.S.: some states do not allow the exclusion or limitation of incidental or consequential damages, so the above limitation or exclusion may not apply to you. THERE MAY BE NO IMPLIED WARRANTIES OR GUARANTEES FROM TIARA APPLICABLE TO YOUR BOAT UNDER APPLICABLE LAW, AND ALL IMPLIED OR STATUTORY CONDITIONS, WARRANTIES (INCLUDING ANY WARRANTY OF MERCHANTABILITY OR FITNESS FOR A PARTICULAR PURPOSE) AND GUARANTEES ARE DISCLAIMED WHERE ALLOWED BY LAW. TO THE FULLEST EXTENT ALLOWED BY LAW, ANY AND ALL APPLICABLE CONDITIONS, IMPLIED WARRANTIES AND GUARANTEES (IF ANY), INCLUDING ANY IMPLIED WARRANTY OF MERCHANTABILITY OR PARTICULAR PURPOSE, ARE LIMITED IN DURATION TO THE DURATION OF THE APPLICABLE PROVISIONS OF THIS WRITTEN WARRANTY. For customers in the U.S.: some states do not allow limitations on how long an implied warranty lasts, so the above limitation may not apply to you.

RESPONSIBILITY OF PURCHASER

1. No warranty coverage is provided by Tiara unless the customer and dealer complete and return all Vessel Registration and Customer Acceptance Forms to Tiara Yachts, Inc. within seven (7) days after delivery of the boat to the original purchaser.
2. The original purchaser or approved transferee must notify the Tiara Yachts dealer from which the boat was purchased of any claimed defect within fifteen (15) days after first detecting the claimed defect.
3. If the dealer fails to satisfactorily repair the claimed defect within fifteen (15) days, written notice must then be promptly given directly to Tiara. Tiara is not responsible for unrepaired warranted defects. The boat, including any claimed defective part, must be returned to the Tiara Yachts dealer from which the boat was purchased (or to another dealer or facility as directed by Tiara Yachts) within the warranty period for inspection and warranty service. The expense of returning and transporting the boat or any part for warranty service, and the expense of returning and transporting it back to the owner after repair or replacement, is the responsibility of the owner, and will not be reimbursed by Tiara.
5. If the dealer from whom the boat was purchased is no longer an authorized Tiara Yachts dealer, contact Tiara for instructions on how to obtain warranty service.

S2 reserves the right to improve its products through changes in design or materials without being obligated to the owners of the boats of similar or the same model of prior manufacture. We may be contacted as follows: Tiara Yachts Customer Relations Department, 725 East 40th Street, Holland, Michigan 49423 (616/394-7460) or CR@tiarayachts.com.



SUPPLEMENTAL LIMITED WARRANTY INFORMATION ON FINISHED WOOD COMPONENTS

Your Tiara Yachts® Boat may be furnished with certain finished wood panels and components that require periodic maintenance and refinishing to maintain their appearance and finish. S2 Yachts, Inc.'s Limited Warranty coverage does not include the matching of wood grains, or the condition or durability of any finishes for such panels and components. This statement supplements S2 Yachts, Inc.'s Limited Warranty with respect to these wood panels and components. All other terms of S2 Yachts, Inc.'s Limited Warranty remain in effect, and you should refer to the Limited Warranty for other terms, conditions and requirements

CALIFORNIA EVAPORATIVE EMISSIONS CONTROL SYSTEM WARRANTY STATEMENT: YOUR WARRANTY RIGHTS AND OBLIGATIONS

The California Air Resources Board and S2 Yachts, Inc. is pleased to explain the evaporative emission control system's warranty on your 2025 model year spark-ignition marine watercraft. In California, new spark-ignition marine watercraft (SIMW) must be designed, built, and equipped to meet the State's stringent anti-smog standards. S2 Yachts, Inc. must warrant the evaporative emission control system on your spark-ignition marine watercraft for the period listed below provided there has been no abuse, neglect, or improper maintenance of your SIMW.

Your evaporative emissions control system may include parts such as: canisters, carburetors, clamps, connectors, filters, fuel caps, fuel lines, fuel tanks, valves, vapor hoses, and other associated evaporative emissions control system components.

MANUFACTURER'S WARRANTY COVERAGE:

This evaporative emission control system is warranted for two years. If any evaporative emission-related part on your SIMW is defective, the part will be repaired or replaced by S2 Yachts, Inc.

OWNER'S WARRANTY RESPONSIBILITIES:

- As the spark-ignition marine watercraft owner, you are responsible for performance of the required maintenance listed in your owner's manual. S2 Yachts, Inc. recommends that you retain all receipts covering maintenance on your spark-ignition marine watercraft, but S2 Yachts, Inc. cannot deny warranty solely for the lack of receipts.
- As the spark-ignition marine watercraft owner, you should however be aware that S2 Yachts, Inc. may deny you warranty coverage if your spark-ignition marine watercraft or a part has failed due to abuse, neglect, or improper maintenance or unapproved modifications.
- You are responsible for presenting your spark-ignition marine watercraft to a S2 Yachts, Inc. dealer or authorized service center as soon as the problem exists. The warranty repairs should be completed in a reasonable amount of time, not to exceed 30 days. If you have a question regarding your warranty coverage, you should contact S2 Yachts, Inc. at 1-616-392-7163.

The California evaporative emissions control system warranty covers the following list of components:

- | | |
|-------------------------------------|--|
| (1) Canister Mounting Brackets | (11) Fuel Line |
| (2) Carbon Canister | (12) Fuel Line Fittings |
| (3) Carburetor Purge Port Connector | (13) Fuel Tank |
| (4) Clamps* | (14) Liquid/Vapor Separator |
| (5) Control Cables* | (15) Pressure Relief Valves* |
| (6) Control Linkages* | (16) Purge Valves |
| (7) Control Solenoids* | (17) Vacuum Control Diaphragms* |
| (8) Control Valves* | (18) Vapor Hoses |
| (9) Electronic Controls* | (19) All other parts not listed that may affect the evaporative emissions control system |
| (10) Fuel Cap | |

*Note: As they relate to the evaporative emissions control system.

Safety Information

Your owner's manual was written to include safety instructions to ensure safe operation and maintenance of your boat. This manual uses safety symbols to alert you to potential personal injury hazards.

 **DANGER**

Indicates a hazardous situation which, if not avoided, will result in death or serious injury.

 **WARNING**

Indicates a hazardous situation which, if not avoided, could result in death or serious injury.

 **CAUTION**

Indicates a hazardous situation which, if not avoided, could result in minor or moderate injury.

 **NOTICE**

Indicates a potentially hazardous situation which, if not avoided, may result in property damage.

All instructions in this manual should be viewed from the stern looking toward the bow, with starboard to your right and port to your left. A glossary of boating terms is included.

Your boat produces carbon monoxide (CO) and uses flammable fuel. Carbon monoxide gas (CO) is colorless, odorless and extremely dangerous. CO will cause BRAIN DAMAGE or DEATH.

Every precaution has been taken by S2 Yachts to reduce the risks associated with death, possible injury and damage from fire or explosion. Your own precaution and good maintenance procedures are necessary in order to enjoy safe operation of your boat.

 **DANGER**

Exposure to carbon monoxide will cause death or serious injury. Avoid direct and prolonged exposure to CO.

Gasoline and other fuels are extremely flammable and highly explosive under certain conditions.

- DO NOT smoke or allow open flame or sparks nearby when fueling.
- DO NOT block fuel vents.
- DO NOT store fuel in any containers or compartments which are not designated for storing fuel.

Table of Contents

Safety Labels

Interior	1
Exterior	2
Safety Label Locations	4

General Information

Engine and General Specifications	9
Boat Information	10

Pre-Cruise Checklist

Fire Extinguisher Locations	13
Pre-Cruise Checklist.....	13

Propulsion Systems

1.1 General.....	1-1
1.2 Saltwater Application	1-1
1.3 Engine Lubrication.....	1-2
1.4 Engine Cooling System	1-2
1.5 Propellers	1-2
1.6 Engine Instrumentation.....	1-2
1.7 Seakeeper Gyro Stabilization System (optional).....	1-3

Helm Systems

2.1 General.....	2-1
2.2 Helm Access.....	2-1
2.3 Engine Monitoring Display.....	2-1
2.4 Engine Throttle and Shift Controls.....	2-1
2.5 Neutral Safety Switch	2-2
2.6 Automatic Fire Suppression System	2-2
2.7 Engine Stop Switch	2-3
2.8 Engine Power Tilt and Trim.....	2-4
2.9 Steering System	2-4
2.10 Trim Tabs	2-5
2.11 Compass.....	2-6
2.12 Bow Thruster	2-6
2.13 Joystick (optional).....	2-6
2.14 Spotlight (optional).....	2-7

Fuel Systems

3.1 General.....	3-1
3.2 Fuel System.....	3-1
3.3 Diesel Generator Fuel System	3-4
3.4 Fuel System Maintenance.....	3-6

Electrical Systems

4.1 General.....	4-1
4.2 12-Volt DC System	4-1
4.3 Master DC Panel Breakers	4-3
4.4 DC Distribution Panel	4-4
4.5 Seakeeper Gyro (optional)	4-5
4.6 AC System.....	4-6
4.7 AC Distribution Panel.....	4-6
4.8 Other Electrical Controls.....	4-7
4.9 Shore Power Connection.....	4-7
4.10 Generator (optional)	4-8
4.11 Electrical System Maintenance.....	4-10

Plumbing Systems

5.1 Freshwater System.....	5-1
5.2 Freshwater System Commissioning	5-2
5.3 Marine Head System	5-5
5.4 Washdowns (optional).....	5-7
5.5 Drainage	5-8
5.6 Plumbing System Maintenance.....	5-9

Ventilation Systems

6.1 Air Conditioning System	6-1
6.2 Portlights	6-1
6.3 Carbon Monoxide	6-2
6.4 Bilge Ventilation.....	6-2
6.5 Maintenance	6-2

Exterior Equipment

7.1 Forward Deck	7-1
7.2 Hardtop.....	7-3
7.3 Mid Cockpit.....	7-4

7.4 Mid Cockpit Galley.....	7-5
7.5 Aft Cockpit	7-5
7.6 Stern	7-7

Interior Equipment

8.1 Safety Equipment	8-1
8.2 Companionway	8-1
8.3 Main Cabin	8-1
8.4 Head Compartment	8-2
8.5 Marine Head System	8-2

Safety Information

9.1 General.....	9-1
9.2 Engine Alarms	9-1
9.3 Neutral Safety Switch	9-1
9.4 Engine Stop Switch	9-1
9.5 Fire Safety	9-2
9.6 Carbon Monoxide Safety	9-4
9.7 First Aid.....	9-6
9.8 Required Safety Equipment.....	9-6
9.9 Additional Safety Equipment.....	9-8

Operation

10.1 General.....	10-1
10.2 Homeland Security Restrictions	10-2
10.3 Rules of the Road.....	10-2
10.4 Operating your Boat	10-3
10.5 Docking, Anchoring, and Mooring.....	10-5
10.6 Controls, Steering, or Propulsion System Failure	10-7
10.7 Collision.....	10-7
10.8 Grounding, Towing, and Rendering Assistance.....	10-7
10.9 Flooding or Capsizing.....	10-8
10.10 Transporting your Boat	10-8
10.11 Man Overboard.....	10-8
10.12 Trash Disposal.....	10-9
10.13 Multi-Colored Lighting.....	10-9

Routine Maintenance

11.1 General.....	11-1
11.2 Exterior Hull and Deck	11-1
11.3 Seats and Upholstery	11-5
11.4 Cabin Interior	11-6
11.5 Bilge.....	11-6
11.6 Electrical	11-6
11.7 Generator.....	11-6

Seasonal Maintenance

12.1 Winterizing.....	12-1
12.2 Storage and Lay-up	12-3
12.3 Recommissioning	12-5

Appendices

Glossary of Terms.....	A-1
------------------------	-----

Appendices

Glossary of Terms.....	A-1
Maintenance Guides.....	B-1
Maintenance Schedule.....	C-1
Boating Accident Report.....	D-1
Float Plan	E-1
Troubleshooting Guide	F-1
Schematics	G-1

Safety Labels

The following diagrams indicate where safety labels can be found on your Tiara Yacht. Numbers correspond to the table that follows, which lists the replacement part number (P/N) for each label. To obtain replacement labels, contact your Tiara Yachts dealer.

Interior

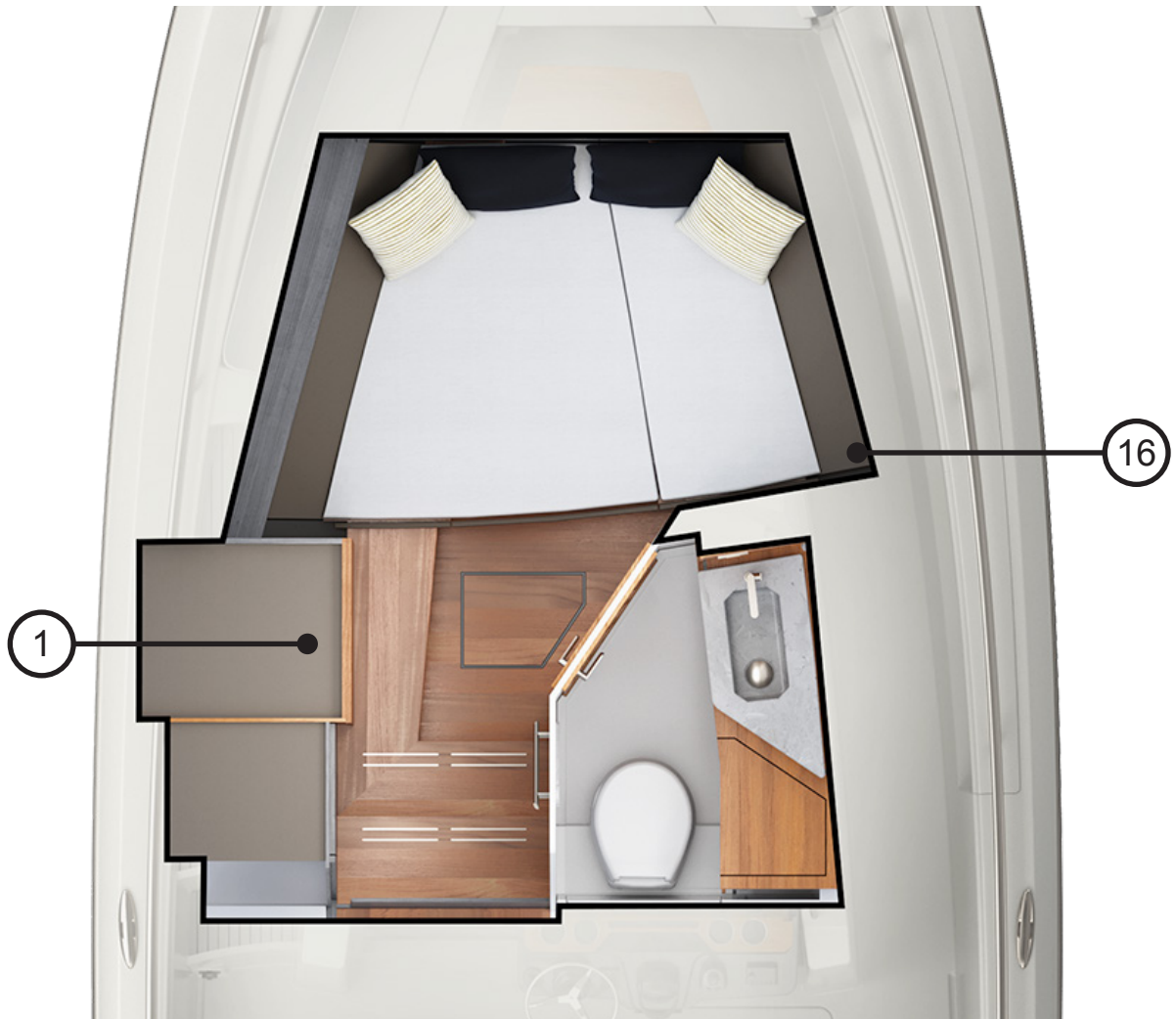



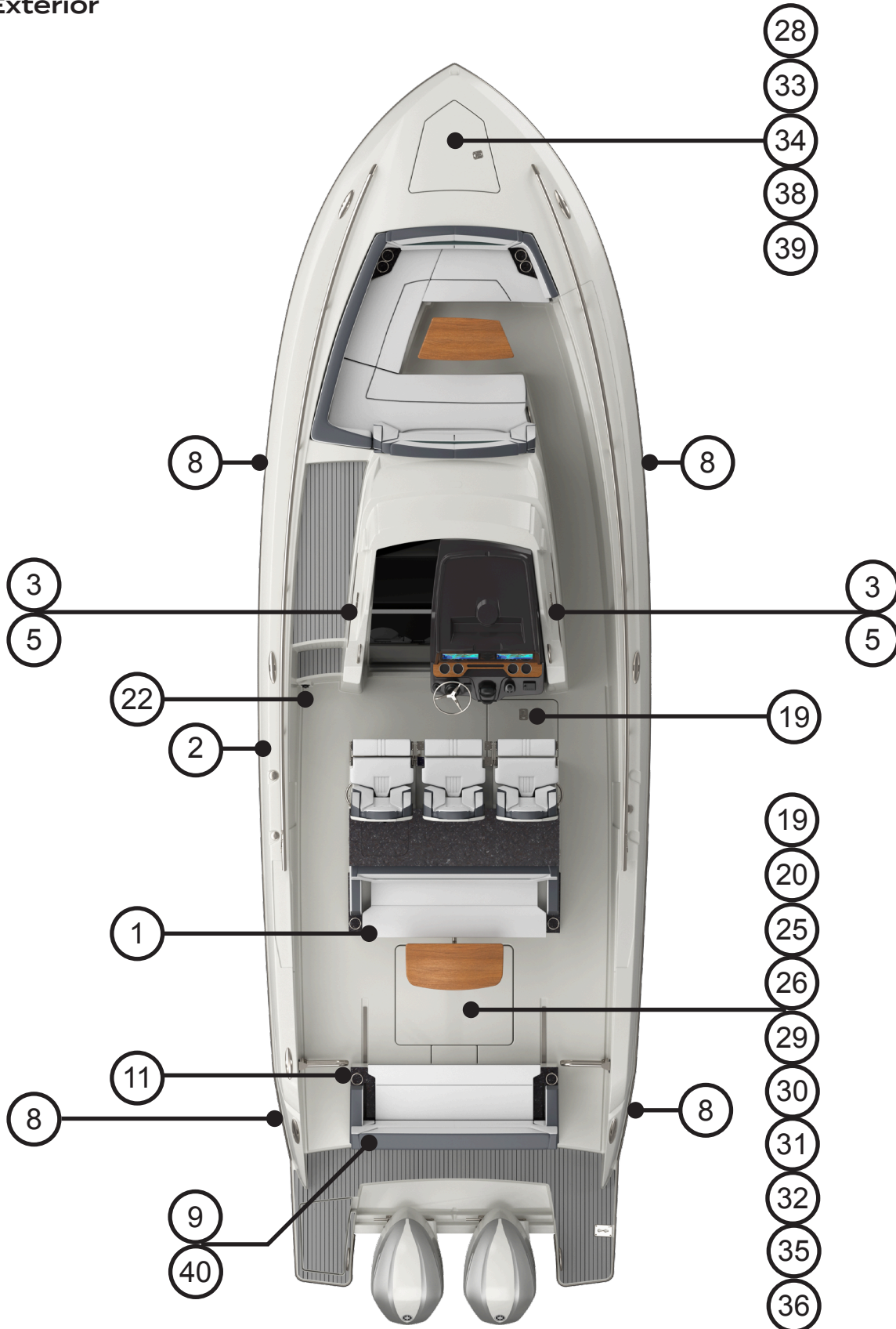

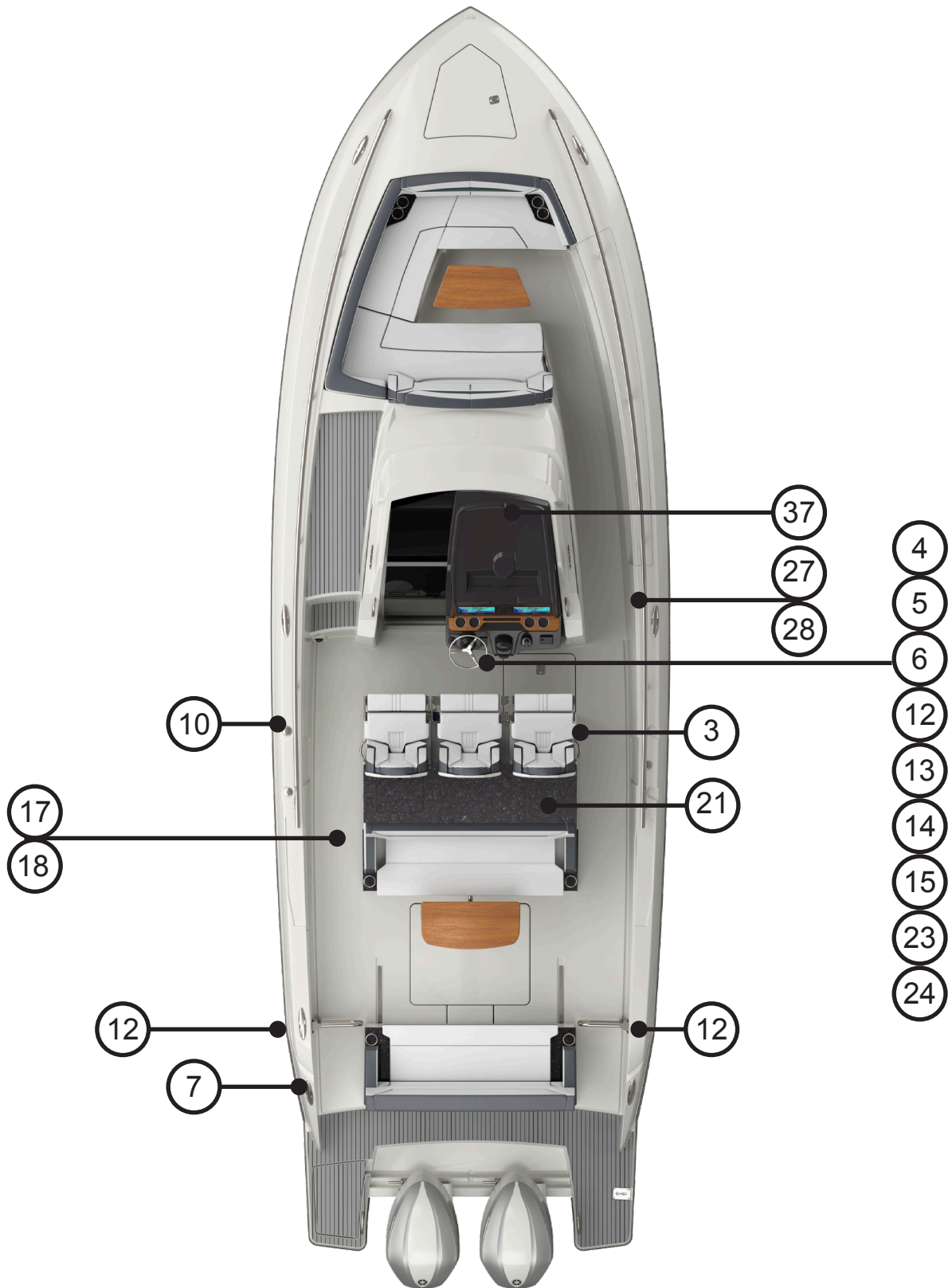

Exterior





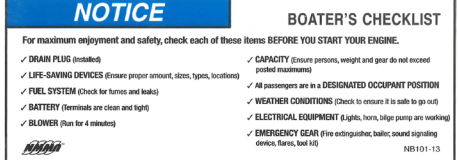

Safety Labels





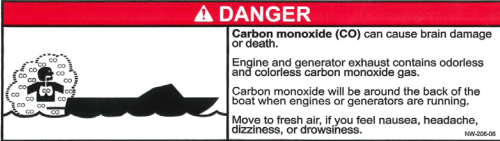

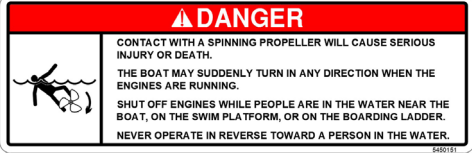
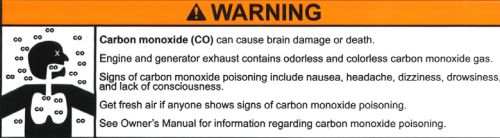
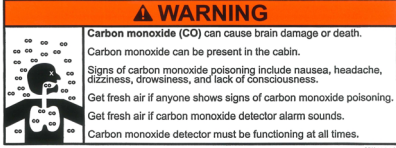

Safety Labels

1	<p>FIRE EXTINGUISHER INSIDE P/N: 5452010 Location: Cabin port hanging locker & aft cockpit port aft-facing seat base</p>	
2	<p>NO SMOKING P/N: 5451130 Location: Fuel fill(s)</p>	
3	<p>NOTICE: FIRE EXTINGUISHING SYSTEM P/N: 5453300 Location: Helm seat base near Fireboy discharge pull (if installed)</p>	
4	<p>NOTICE: KEEP HATCHES CLOSED P/N: 5455660 Location: Helm</p>	
5	<p>BOATERS CHECK LIST P/N: 5450120 Location: Helm</p>	
6	<p>YACHT CERTIFICATION PLATE P/N: 5450052 Location: Helm</p>	
7	<p>NMMA CERTIFIED P/N: 5455250 Location: Port transom wing</p>	
8	<p>SLING P/N: 5450240 Location: Port & starboard hull sides</p>	



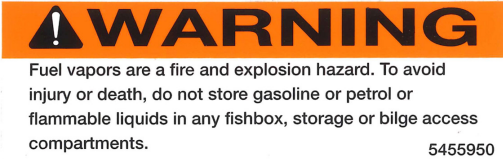

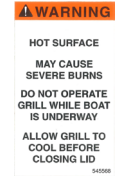

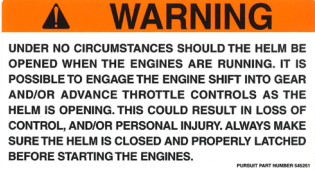
Safety Labels

9	<p>DANGER: CARBON MONOXIDE P/N: 5453650 Location: Port transom walkway</p>	
10	<p>WARNING: FILL WITH DIESEL ONLY P/N: 5454580 Location: Diesel fuel fill</p>	
11	<p>UNSAFE BOAT HAZARD P/N: 5450081 Location: Port side of aft lounge seat base</p>	
12	<p>WARNING: CLOSE TRANSOM DOOR P/N: 5453220 Location: Helm, and near port transom gate & starboard transom gate</p>	
13	<p>WARNING: LEAKING FUEL P/N: 5450060 Location: Helm</p>	
14	<p>DANGER: ROTATING PROPELLERS P/N: 5450151 Location: Helm</p>	
15	<p>WARNING: CARBON MONOXIDE P/N: 5453690 Location: Helm</p>	
16	<p>WARNING: CARBON MONOXIDE P/N: 5453680 Location: Cabin starboard aft corner</p>	

Safety Labels

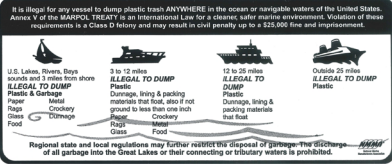
17	<p>WARNING: SUNSHADE STOWAGE P/N: 5450054 Location: Underside of port hardtop</p>	
18	<p>WARNING: HARDTOP P/N: 5453160 Location: Underside of port hardtop</p>	
19	<p>WARNING: FUEL VAPORS P/N: 5455950 Location: Mechanical space and starboard helm seat floor storage hatches</p>	
20	<p>WARNING: DO NOT DRILL P/N: 5400081 Location: Mechanical space</p>	
21	<p>WARNING: GRILL BURN WARNING P/N: 5455680 Location: Underside of grill lid</p>	
22	<p>WARNING: HAZARDOUS VOLTAGE P/N: 5451110 Location: Shore power cord outlet</p>	
23	<p>WARNING: CLOSE HELM BEFORE STARTING P/N: 5452510 Location: Helm</p>	

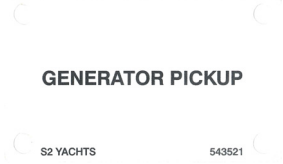
Safety Labels

<p>24</p>	<p>TAG: CALIFORNIA PROP 65 P/N: 9253280 Location: Steering Wheel</p>	
<p>25</p>	<p>DISCHARGE OF OIL PROHIBITED P/N: 5450190 Location: Underside of mechanical space hatch</p>	<p>DISCHARGE OF OIL PROHIBITED THE FEDERAL WATER POLLUTION CONTROL ACT PROHIBITS THE DISCHARGE OF OIL OR OILY WASTE INTO OR UPON THE NAVIGABLE WATERS OF THE UNITED STATES, OR THE WATERS OF THE CONTIGUOUS ZONE, OR WHICH MAY AFFECT NATURAL RESOURCES BELONGING TO, APPERTAINING TO, OR UNDER THE EXCLUSIVE MANAGEMENT AUTHORITY OF THE UNITED STATES. IF SUCH DISCHARGE CAUSES A FILM OR DISCOLORATION OF THE SURFACE OF THE WATER OR CAUSES A SLUDGE OR EMULSION BENEATH THE SURFACE OF THE WATER, VIOLATORS ARE SUBJECT TO SUBSTANTIAL CIVIL PENALTIES AND/OR CRIMINAL SANCTIONS INCLUDING FINES AND IMPRISONMENT.</p> 
<p>26</p>	<p>DUMPING TRASH OVERBOARD P/N: 5451640 Location: Underside of mechanical space hatch</p>	
<p>27</p>	<p>FRESH WATER P/N: 5450260 Location: Starboard wash down connection</p>	
<p>28</p>	<p>RAW WATER P/N: 5450270 Location: Starboard wash down connection & anchor locker</p>	
<p>29</p>	<p>TAG: GENERATOR PICKUP P/N: 5435210 Location: Mechanical space</p>	
<p>30</p>	<p>TAG: HEAD OVERBOARD DISCHARGE P/N: 5435240 Location: Mechanical space</p>	
<p>31</p>	<p>TAG: AIR CONDITIONING PICKUP P/N: 5435250 Location: Mechanical space</p>	

General Information

Engine and General Specifications

Maximum Horsepower (with Twin 400 engines).....	800 HP (596 kw)
Hull Length (transom to bow)	32' 6" (9.91 meters)
L.O.A. with integrated platform.....	34' 9" (10.6 meters)
Beam	11' 0" (3.35 meters)
Draft (fully loaded, motors down).....	3' 1" (94 centimeters)
Draft (motors up)	2' 2" (66 centimeters)
Clearance with Hardtop (from waterline).....	8' 7" (2.6 meters)
Approximate Dry Weight.....	13,500 lbs. (5,715 kg)
Gasoline Fuel Capacity	200 U.S. gallons (757 liters)
Water Capacity	30 U.S. gallons (113 liters)
Holding Tank Capacity.....	20 U.S. gallons (75 liters)
Diesel Capacity (for optional generator)	20 U.S. gallons (75 liters)
Deadrise at Transom	22°

General Information

Boat Information

Fill out the following information and leave it in your Tiara Yachts Owner's Manual. This information will be important for you and Tiara Yachts service personnel to know, if and when you may need to call for technical assistance or service.

Boat	
Model: Tiara Yachts 34 LS	Hull Identification #:
Purchase Date:	Delivery Date:
Ignition Keys:	Registration #:
Engines	
Port Engine	Starboard Engine
Make:	Make:
Model:	Model:
Engine Serial Number:	Engine Serial Number:
Lower Unit Serial Number:	Lower Unit Serial Number:
Propellers	
Make:	Diameter / Pitch:
Blades:	Other:
Generator	
Make:	Model:
Serial #:	kW:
Dealer	Tiara
Name:	Phone #:
Phone #:	Representative:
Sales Associate:	Address:
Service Manager:	
Address:	

Tiara Yachts reserves the right to make changes and improvements in equipment, design and vendor supplied equipment at any time without notification.

General Information

Warranty & Warranty Registration Cards

The S2 Yachts, Inc., Limited Warranty Statement is included with this manual. It has been written to be clearly stated and easily understood. If you have any questions after reading the warranty, please contact Tiara Customer Relations.

S2 Yachts, engine manufacturers, and the suppliers of major components maintain their own manufacturer's warranty and service facilities. It is important that you properly complete the warranty registration cards included with your boat and engine(s) and mail them back to the manufacturers to register your ownership. This should be done within 15 days of the date of purchase and before the boat is put into service. A form for recording this information is provided at the beginning of this manual. This information will be important for you and service personnel to know, if and when you may need service or technical information.

The boat warranty registration requires the **Hull Identification Number (HIN)** which is located on the starboard side of the transom, just below the rub rail. The engine warranty registration requires the engine serial number(s). Refer to the engine owner's manual for the location of the serial number(s).

Federal Boat Safety Act

All boat manufacturers are required by the Federal Boat Safety Act of 1971 to notify first-time owners in the event any defect is discovered "which creates a substantial risk of personal injury to the public." It is essential that we have your warranty registration card, complete with your name and mailing address, in our files so that we can comply with the law if it should become necessary.

Product Changes

S2 Yachts is committed to the continuous improvement of our boats. As a result, some

of the equipment described in this manual or pictured in the catalog may change or no longer be available.

S2 Yachts **reserves the right to change standard equipment, optional equipment, and specifications without notice or obligation.** If you have questions about the equipment on your Tiara Yacht, please contact Tiara Customer Relations.

Transferring the Warranty

For a transfer fee, S2 Yachts will extend warranty coverage to subsequent owners of Tiara Yachts models for the duration of the original warranty period. Please refer to the Tiara Limited Warranty Statement for the procedure to transfer the warranty. To take advantage of this program, notification of the change of ownership, including the new owner's name, address, and telephone number together with the appropriate fee, must be sent to Tiara Yachts within 30 days of the date of resale. Contact Tiara Customer Relations for details.

S2 Yachts will confirm, in writing, that the transfer of the warranty has taken place, after which the transferee will be treated as the original purchaser as outlined in the Tiara Limited Warranty Statement.

Owner/Operator Responsibilities

Registration and Documentation

Federal law requires all undocumented vessels equipped with propulsion machinery be registered in the state of principal use. A certificate of documentation will be issued upon registration. These registration numbers must be displayed on your boat. The owner/operator of a boat must carry a valid certificate of registration whenever the boat is in use. When moved to a new state of principal use, the certificate is valid for 60 days.

In order to be valid, the numbers must be installed to the proper specifications. Check with your dealer or state boating authority for numbering requirements. The Coast Guard issues the certificate of number in Alaska; all others are issued by the state.

Insurance

In most states the boat owner is legally responsible for damages or injuries the boat causes. Responsible boaters carry adequate liability and property damage insurance for their boat. You should also protect the boat against physical damage and theft. Some states have laws requiring minimum insurance coverage. Contact your dealer or state boating authority for information on the insurance requirements in your boating area.

Reporting Boating Accidents

All boating accidents must be reported by the owner or operator of the boat to the proper marine law enforcement authority for the state in which the accident occurred. Immediate notification is required if a person dies or disappears as a result of a recreational boating accident.

If a person dies or there are injuries requiring more than first aid, a formal report must be filed within 48 hours.

A formal report must be made within 10 days for accidents involving more than \$500.00 damage or the complete loss of a boat.

A “Boating Accident Report” form is located near the back of this manual to assist you in reporting an accident. For additional information, visit www.uscgboating.org.

Education

If you are not an experienced boater, we recommend that you and other people that normally accompany you enroll in a boating safety course. Organizations such as the U.S. Power Squadrons, United States Coast Guard Auxiliary, state boating authorities, and

the American Red Cross offer excellent boating educational programs. These courses are worthwhile even for experienced boaters to sharpen your skills or bring you up-to-date on current rules and regulations. They can also help in providing local navigational information when moving to a new boating area. Contact your dealer or state boating authority, or visit www.uscgboating.org for further information on boating safety courses.

Required Equipment

U.S. Coast Guard regulations require certain equipment on each boat. The Coast Guard also sets minimum safety standards for vessels and associated equipment. To meet these standards some of the equipment must be Coast Guard approved. “Coast Guard Approved Equipment” has been determined to be in compliance with USCG specifications and regulations relating to performance, construction or materials. The equipment requirements vary according to the length, type of boat, and the propulsion system. Some of the Coast Guard equipment is described in section 9, Safety Information. For more information, visit www.uscgboating.org or contact your local marine dealer or retailer.

Some state and local agencies go beyond USCG regulations or impose similar equipment requirements on waters that do not fall under Coast Guard jurisdiction. Contact your dealer or local boating authority for additional information regarding the equipment requirements for that boating area.

EPA Compliant Fuel System

EPA (Environmental Protection Agency) regulations require additional emissions related components for the fuel tank, fuel fill and fuel vent systems. It is unlawful to remove or intentionally defeat these emission related components.

Pre-Cruise Checklist

Fire Extinguisher Locations

This boat is equipped with a fire suppression system. See section 9, Safety Information, for details.

There are two (2) fire extinguishers installed on this boat. Make sure they are fully charged. Fire extinguishers are located:

- inside the cockpit port aft-facing seat base
- in the port cabin hanging locker

Pre-Cruise Checklist

Before casting off on your voyage, ensure that proper safety gear is aboard. Familiarize yourself with all engine controls, steering operation, starting procedure, and how to interface with the helm multi-function displays (MFDs) and other instrumentation. Understand local regulations and waterways, and review the contents of this owner's manual before casting off.

Before your voyage:

- Check the weather forecast. Decide if your planned cruise can be made safely.
- Make sure all required documents are onboard.
- Make sure all necessary safety equipment (items like running lights, spotlight, life saving devices, etc.) is onboard and operative. Refer to section 9, Safety Information, for additional information.
- Each person onboard must have at least one personal flotation device. Check the U.S. Coast Guard standards for the correct type required for your boat.
- Make sure signal kits are onboard, in good operating condition, and not expired.
- Make sure all fire extinguishers are in position and in good operating condition.
- Make sure you have sufficient water and other provisions for the planned cruise.
- Leave a written message listing details of your planned cruise (Float Plan) with

a friend ashore. Include a description of your boat, where you intend to cruise, schedule of your arrival in the cruising area, and when you expect to return. Keep the person informed of any changes in your plan to prevent false alarms. This information can tell authorities where to look and your boat type in the event you fail to arrive.

- Check the amount of fuel onboard. Observe the "rule of thirds": one third of the fuel for the trip out, one third to return and one third in reserve. An additional 15% may be consumed in rough seas.
- Check the water-separating fuel filters for water.
- Turn on the battery switches.
- Check for bilge water and for other signs of potential problems. Monitor for the scent of fuel fumes.
- Test the automatic and manual bilge pump switches to make sure the system is working properly.
- Have a tool kit and spare parts onboard (see below).

Before starting the engines:

- Make sure the shift control is in NEUTRAL.
- Make sure the emergency engine stop lanyard is attached to the operator and the stop switch.

See section 10, Operation, for additional important information regarding how to safely operate your boat.

Tool kit

Have a tool kit and spare parts onboard. **The kit should include basic tools:**

- Spark plug wrench
- Hammer
- Spark plug gap gauge
- Electrician's tape
- Screwdrivers
- Lubricating Oil

Pre-Cruise Checklist

- Pliers
- Jackknife
- Adjustable wrench
- Vise grip pliers
- Needle nose pliers
- Wire crimping tool
- End wrench set
- Wire connector set

The spare parts kit should include:

- Extra light bulbs
- Spark plugs
- Fuses and circuit breakers
- Flashlight and batteries
- Drain plugs
- Engine oil
- Propellers
- Fuel filters
- Propeller nuts
- Fuel hose and clamps

Propulsion Systems

1.1 General

Your Tiara Yacht is designed to be powered with outboard engines. The manufacturer of the outboard engines provides an owner’s information manual. It is important you read and understand the information and become familiar with the warranty, operation, and maintenance of the engines and drive systems.

 **WARNING**

MOVING PARTS HAZARD
 Contact with moving parts can entangle, cut and cause death or serious injury. **DO NOT** get close enough to make contact with any running machinery moving parts, i.e., engine or propeller. Contact can result in loss of body parts, strangulation, burns, and/or severe loss of blood resulting in death or serious injury.

 **NOTICE**

DO NOT attempt to service any part of the outboard or boat systems unless you are familiar or qualified to do so. Do not use parts which are not designed for a marine application.

 **NOTICE**

Use only the fuel recommended by the engine manufacturer. Use of old, contaminated fuel can cause engine malfunction or severe damage.

1.2 Saltwater Application

Each outboard engine is a complete drive system with the gear case (transmission) forward of the propeller and connected to the power head with a vertical drive shaft. Other than the routine maintenance outlined in the engine owner’s manual, there is little to be concerned with unless the boat is to be kept in saltwater for extended periods. Marine growth will occur when components are left in the water for extended periods and can cause poor performance or permanent damage to the exposed components. The type of growth and how quickly it occurs is relative to the water conditions in your boating area. Water temperature, pollution, current, etc., can have an effect on marine growth.

Galvanic corrosion is the corrosion process occurring when different metals are submerged in an electrolyte. Sea water is an electrolyte and submerged engine components must be properly protected. Outboard engines are equipped with sacrificial anodes to help prevent galvanic corrosion problems. The anodes must be monitored and replaced as necessary. For locations and maintenance, refer to the engine owner’s manual.

When leaving the boat in the water, tilt the motors as high as possible to decrease the risk of damage from galvanic corrosion or marine growth around the cooling inlets, propeller, and exhaust ports.

 **CAUTION**

DO NOT use copper-based coatings or any coatings not approved for use with aluminum. Some paint manufacturers claim their paints are safe for aluminum. Copper components and copper-based paints can cause severe corrosion to aluminum. **DO NOT** use copper-based paints. Mercury or mercury-based compounds that come into contact with aluminum will result in severe corrosion.

1.3 Engine Lubrication

Four-cycle engines have an oil sump in the crankcase. Use the oil type, grade, and level recommended by the engine manufacturer. It is normal for 4-cycle engines to consume a small amount of oil. Check the oil level before each use and change it following the engine manufacturer's recommendation.

Refer to section 3, Fuel Systems, and the engine owner's manual for oil specifications and additional information on the oil injection system.

NOTICE

Use only the oil recommended by the engine manufacturer, and monitor the oil level. The use of any other type of oil can cause severe damage or engine malfunction.

1.4 Engine Cooling System

Outboard engines are raw water (sea water) cooled. Water is pumped through the water inlets, circulated through the engine block, and expelled with the exhaust through the exhaust port, water port, and propeller hub. The water pump uses a small impeller made of synthetic rubber. The impeller and water pump cannot run dry for more than a few seconds. In most outboard engines, some cooling water is diverted through the ports below the engine cowling. This allows the operator to visually check the operation of the cooling system. When the engine is started, make sure a steady stream of water is present.

If the boat is used in salt or badly polluted water, flush the engines after each use to reduce corrosion. Refer to your engine package owner's manual for the proper engine flushing procedure.



CAUTION

DO NOT operate an engine out of the water, even momentarily. Water must be supplied to the cooling system of the power head and water pump, or serious damage will result. If it is necessary to run the engine out of the water, connect it to an engine flush attachment designed for your specific engine.

1.5 Propellers

The propellers convert the power of the engines into thrust. Propellers vary in style, diameters and pitch. The best set for your needs will depend on your application and expected average load. Propeller sizes are identified by two numbers stamped on the prop in sequence; the first is the diameter and the second is the pitch (example 14 x 21). Pitch is the theoretical distance the propeller will travel in one rotation.

Repair or replace a propeller immediately if it has been damaged. A damaged propeller can cause vibration that can be felt in the boat and can damage the engine gear case. Refer to the engine owner's manual for information on propeller removal and installation.

1.6 Engine Instrumentation

The helm is equipped with two multi-function displays (MFDs). The MFDs allow the operator to monitor all engine functions (including fuel level and engine trim), operate the engines most efficiently, and prevent serious costly damage. The exact instrumentation is unique to the type of outboard engines installed on your boat. Refer to your engine package owner's manuals for more information.

Your boat is equipped with a monitoring display supplied by the manufacturer of your engine package. Refer to the engine owner's manual for more information.



NOTICE

DO NOT exceed maximum recommended engine RPM. Exceeding, maintaining, or coming close to maintaining maximum RPM can reduce engine life.



NOTICE

Continued operation of an overheated engine will cause severe engine damage. If the engine overheats, shut off the engine, investigate the problem, and correct it.



CAUTION

If an engine alarm sounds, shut off the engine, investigate the problem, and correct it.

1.7 Seakeeper Gyro Stabilization System (optional)

To operate the optional Seakeeper[®] Gyro Stabilization System, if installed, use the control panel located on the helm. Refer to section 4, Electrical Systems, and the Seakeeper owner's manual for more information.

Helm Systems

2.1 General

The helm controls consist of engine throttle and shift controls, steering system, trim tab control switches, and either joystick or bow thruster controls.

The manufacturer of each control component provides an owner’s manual with its product. It is important that you read, understand, and become familiar with the proper care and operation of all control systems.

For information about the DC component buttons on the helm, see section 4, Electrical Systems.

2.2 Helm Access

The helm station is hinged at the bottom and opens to provide service access to the helm equipment. To open, slide the helm seat back to its furthest aft position, tilt the steering wheel to the full upright position, and unscrew the knurled knobs located on top of the helm and forward (toward the windshield). A strap holds the helm in the open position. To secure the helm back in place, close the helm and secure the knobs. The helm station must be secured before operating or transporting your boat, to prevent injury or damage. Do not open the helm station with engines running; accidental engagement of shift and throttle levers can occur.

 WARNING
LOSS OF CONTROL AND UNSAFE BOAT HAZARD
<p>Improper securing of the helm is hazardous and can cause death or serious injury from sudden loss of control. Make sure the helm is secure before getting underway and when transporting the boat.</p>

 CAUTION
<p>Service or repairs to equipment inside your console should be performed by your Tiara Yachts dealer or other qualified marine repair technician. Failure to do so could result in damage to equipment used to safely operate the boat.</p>

2.3 Engine Monitoring Display

The helm is equipped with an engine-monitoring, multi-function display (MFD). Use the MFD to monitor all engine functions (including fuel level and motor trim), operate the engines most efficiently, and prevent serious, costly damage. The exact instrumentation is unique to the type of outboard engines installed on your boat. Refer to your engine package owner’s manual for information, features, and operation of this device.

2.4 Engine Throttle and Shift Controls

Depending on your boat’s engine package, starting the engines will require turning the key in the ignition and pressing the start button, or using an RFID key fob and ignition panel. Refer to your engine package owner’s manual for more information.

The specific shift and throttle controls installed on this Tiara Yacht will depend on your boat’s engine package. The following control description is typical to most outboard remote controls. Refer to your engine package owner’s manuals for specific information about the controls installed on your boat.

The helm is designed for a binnacle-style control with two throttle levers. Each throttle has a position for neutral (straight up and down), forward position (first detent forward of neutral), and reverse position (the first detent aft of neutral). Advancing the control lever beyond the shift range will advance the throt-

tle forward or reverse. Refer to your engine package owner's manual for information about the operation of your specific engine package.

CAUTION

To avoid possible injury or engine damage when shifting:

- **Pause in neutral before shifting from FORWARD to REVERSE, or REVERSE to NEUTRAL.**
- **DO NOT shift into reverse while traveling forward at speed.**
- **Keep the area around the shifter control clear of obstructions.**

If the starter engages with the shift controls in any position other than neutral, the neutral safety switch is not functioning properly and must be repaired before using your boat.

Control Systems Maintenance

Periodic inspection should be made of the control systems and all connections. Periodic lubrication of all moving parts and connections, using light waterproof grease, is required. Signs of rust, corrosion, wear, or other deterioration must be serviced immediately.

If control system adjustments become necessary, see your Tiara Yachts dealer.

2.5 Neutral Safety Switch

Every control has a neutral safety switch to prevent the engine from being started while in gear. Test the neutral safety switches periodically to ensure they are operating. To test the neutral safety switches, tilt the engines down and move the shift levers to the forward position, past first detent. **DO NOT** advance past the idle position. Attempt to start the engines following the directions in your engine owner's manual. The starter should not engage for any engine.

Repeat the test with the shift levers in reverse and the engine throttles at idle; the starter should not engage for any engine. If an engine starts in gear during this test, immediately move the control levers to the neutral position and turn the engine off. Ejection or sudden loss of control can occur if the neutral safety switch system does not function properly and an engine can start in gear.

WARNING

Test the neutral safety switch periodically. If the switch is not operating properly, DO NOT use the boat. Contact your Tiara Yachts dealer and have it repaired. A neutral safety switch not operating properly can allow the boat to start in FORWARD or REVERSE, causing sudden boat movement and throwing operator and passengers.

WARNING

LOSS OF CONTROL AND UNSAFE BOAT HAZARD

A neutral safety switch that does not function properly can cause death or serious injury. DO NOT operate the boat if the switch does not function properly.

2.6 Automatic Fire Suppression System

On generator-equipped boats, the Fireboy fire suppression system protects the generator compartment in case of fire. To manually discharge the fire suppression system, remove the pin and pull the red handle of the fire system manual discharge pull, located on the starboard helm seat base (under the seat).



Fire system manual discharge pull



Fire suppression system status panel and override button

2.7 Engine Stop Switch

Your Tiara Yacht is equipped with an engine stop switch and lanyard at the helm. When the lanyard is pulled away, it will shut off the engines.

Attach the engine stop switch lanyard to a strong piece of clothing on the operator. The engines will not start if the clip is not inserted into the stop switch. Make sure the lanyard is properly attached to the engine stop switch before attempting to start the engine.



Engine stop switch and lanyard (typical)

The Fireboy status panel, mounted on the helm console below the engine stop switch, indicates if the system is charged or discharged. If the system is discharged, an audible alert will sound.

After the fire suppression system discharges, use the helm BLOWER switch to run the mechanical space blower for five minutes before opening the generator compartment. Reset the system using the override button on the status panel. Do not operate the boat until the fire suppression system has been recharged by your Tiara Yachts dealer or other qualified professional.

For additional important information, see section 9, Safety Information, and the automatic fire suppression system owner’s manual.

⚠ WARNING

LOSS OF CONTROL AND UNSAFE BOAT HAZARD

An engine stop switch system that does not function properly or is not used can cause death or serious injury. DO NOT operate the boat if the emergency stop switch system does not function properly.

DO NOT use the switch to stop the boat under normal operation. Test the switch periodically. If the switch is not operating properly, DO NOT use the boat. Contact your Tiara Yachts dealer and have it repaired.

Refer to the engine stop switch information in section 9, Safety Information, and the engine owner’s manual for more information on the engine stop switch.

2.8 Engine Power Tilt and Trim

The outboard engines used on your boat have a tilt and trim feature. The tilt and trim switches are usually built into the engine shift and throttle controls, and allow the operator to control the position of the outboards from the helm. Moving the gear cases closer to the boat transom is called trimming 'in' or 'down.' Moving the gear cases away from the boat transom is called trimming 'out' or 'up.' In most cases, the boat will perform best with the outboards adjusted so the hull will run at a three to five degree angle to the water.

The term 'trim' refers to the adjustment of the outboards within the first 20 degree range of travel. This is the range used while operating your boat on plane. The term 'tilt' refers to adjusting the outboards up for shallow water operation, trailering, or 'tilting' the outboards out of the water. Refer to the engine owner's manual for information on the proper use and maintenance of the power tilt and trim.



CAUTION

The outboard hoses and cables and the transom gel coat can be damaged if the engine(s) are tilted to full up position or turned in the wrong direction. Turn the steering wheel completely to one direction or the other before tilting up to determine which direction is best for your boat.

2.9 Steering System

Your Tiara Yacht is equipped with either a steer-by-wire steering system or a combination steer-by-wire/hydraulic steering system. Refer to your steering system owner's manual for more information.

Steering System Maintenance

Periodically inspect all steering hoses, linkages, and helm assemblies. Signs of corrosion, cracking, loosening of fastenings, excessive wear, or deterioration must be cor-

rected immediately. Periodic lubrication of all moving parts and connections with light waterproof grease is required. Failure to do so can lead to steering system failure and result in loss of control.



WARNING

LOSS OF CONTROL AND UNSAFE BOAT HAZARD

Improper maintenance of the steering system is hazardous and can cause death or serious injury from sudden loss of control. Make sure all steering hardware, cables and fluid levels are regularly inspected and maintained. **DO NOT** attempt to service any part of the steering system unless you are qualified to do so. Follow all instructions regarding maintenance procedures in the steering system owner's manual.



Steering pump (typical)

If your boat is equipped with a combination steer-by-wire/hydraulic steering system, check the hydraulic steering fluid level frequently and maintain the proper level. Hydraulic steering systems may need to be purged of air when first used or after repair. Refer to the steering system owner's manual for specifications and service information. Check steering operation and visually inspect for loose or missing hardware before operating the boat. If you suspect the steering

system is damaged, see your Tiara Yachts dealer. DO NOT operate the boat if you suspect the steering system is malfunctioning.

2.10 Trim Tabs

Trim tab switches on the helm are used to control the trim tabs, which are installed on the transom of the hull. The switches are labeled and control bow up and down movements. They also control the starboard and port up and down movements. Bow up and bow down will control the hull planing attitude, while port and starboard up and down provide control for the hull trim side to side.



Trim tab switches

! CAUTION

Before backing your boat at more than idle speed, depress both trim switches to UP to fully retract the trim tabs. Failure to do so could result in damage to trim tab actuators.

Before leaving the dock, make sure the tabs are in the full UP position by holding the trim tab switches in the BOW UP position for ten seconds. Do not continue to operate the switch once the tabs are fully up or down.

Establish the intended heading and cruise speed before attempting to adjust the hull attitude with the trim tabs. Always make slight adjustments to reduce over-correcting. After

stabilizing speed and direction, move the trim tabs to achieve a level, side-to-side running attitude, being careful not to over-trim.

After depressing a trim tab switch, wait a few seconds for the change in the trim plane to take effect. Avoid depressing the switch while awaiting the trim plane reaction; otherwise, by the time the effect is noticeable, the trim tab plane will have moved too far and the boat will be in an overcompensated position.

When running at a speed that will result in the boat falling off plane, lower the tabs slightly, bow down, to improve the running angle and operating efficiency. Lowering tabs too far can reduce operating efficiency and cause difficult steering and handling.

When running at high speeds, make sure the tabs are in the full UP position. Use only the necessary trim plane action to compensate for any listing. Trim tabs are more sensitive at higher speeds. Adjust for this and be prepared to slow down if difficulties arise.

Be extremely careful when operating in a following sea. The effect of trim tabs is amplified under these conditions. Difficulty in steering and handling can result from improper trim tab usage, especially in a following sea; using the switches, raise the tabs to the full bow UP position.

When running into a chop, a slight bow-down attitude will improve the ride. Be careful not to over trim; difficulty in handling can result.

Trim Tab Indicator

The trim tab switches are labeled to indicate the reaction of the bow of the boat. The L.E.D. lights indicate the position of the trim tabs. When adjusting the starboard bow up or down, the L.E.D. lights on the right side of the panel will activate, indicating the movement of the port tab. Refer to the trim tab operation manual.

Trim Tab Maintenance

Marine growth can affect the operation of the trim tab planes and actuators. To help reduce marine growth, return the trim tabs to the full UP position after operating the boat. Inspect and clean the actuators and planes regularly.

The trim tabs also include a zinc anode to help prevent galvanic corrosion. Galvanic corrosion occurs when different metals are submerged in an electrolyte. Sea water is an electrolyte and submerged metal components must be protected. Anodes were factory installed and need to be replaced when they are 75% of their original size.

Refer to the sacrificial anodes information in section 11, Routine Maintenance, and the trim tab owner's manual for additional maintenance information and fluid specifications.

2.11 Compass

The compass is located at the helm. To adjust the compass, read the instructions on 'Compass Compensation' provided with this manual. The compass cannot be adjusted accurately at the factory; it must be compensated for the influence of the electrical equipment and electronics unique to your boat. The compass should be adjusted by a professional after all electronics and additional electrical accessories are installed and before operating the boat.

2.12 Bow Thruster

The bow thruster is electrically driven and controlled by a joystick on the helm.



Bow thruster control

Operate in short bursts of a few seconds to preserve battery life. Refer to the bow thruster owner's manual for more operation and maintenance information.

For service access to the bow thruster motor, lift the berth mattress and unscrew the access panel.

The bow thruster battery switch is installed on the aft (right) side of the Master DC panel, in the mechanical space.



Bow thruster battery switch



CAUTION

Do not operate the bow thruster out of the water, even momentarily. Water must be supplied to prevent the impeller from over-speeding, which will result in serious damage and void the warranty.



WARNING

ROTATING PARTS HAZARD
A rotating bow thruster can cut, entangle, or draw a swimmer closer or into the thruster, causing death or serious injury. **DO NOT** use the bow thruster near swimmers.

2.13 Joystick (optional)

The optional joystick control, if installed, may be used in place of the steering wheel and shift/throttle levers to control the boat at low speed or during docking maneuvers. With its intuitive operation, the joystick allows the operator to move the boat at various slow speeds in any direction, spin the boat on its own axis, and move the vessel sideways. See your engine package owner's manual for more information.

2.14 Spotlight (optional)

If installed, operate the optional ACR spotlight using the control panel mounted on the helm below the throttle control. Refer to the spotlight owner's manual for operating instructions.



Spotlight control

Fuel Systems

3.1 General

The fuel system of your boat is designed to meet the requirements of the U.S. Coast Guard, Environmental Protection Agency (EPA), National Marine Manufacturers Association (NMMA), and American Boat and Yacht Council (ABYC) in effect at the time of manufacture.

DANGER

FIRE/EXPLOSION HAZARD

Fuel and its vapors are highly explosive when exposed to open flame or spark, resulting in death or serious injury.

- **Make sure no vapors are present before turning on electrical equipment or starting engines.**
- **Make sure fuel is added to the fuel tank only. DO NOT confuse other deck fills with fuel fills.**
- **DO NOT remove anti-siphon valves from the system.**
- **Turn off all electrical switches before servicing the fuel system.**
- **DO NOT drain any fuel into the bilge.**
- **Check all fuel lines and fittings for leaks before and after starting the engines and after any fuel system service.**
- **Prime the fuel system and check all fittings for leaks before and after starting the engines.**
- **DO NOT block fuel vents.**
- **DO NOT store fuel in any containers or compartments not designated for fuel storage.**

S2 Yachts has engineered an improved, EPA-compliant fuel tank fill and vent system. The system reduces or eliminates fuel spillage when using a standard automatic shut-off fuel fill nozzle at marinas and gas stations. While this system provides a clean, consis-

tent refueling experience, it still requires the operator’s attention and must not be defeated by attempts to over-fill the tank with fuel. This system will automatically provide the proper air space (approximately 5% of total tank volume) in the fuel tank to accommodate the expansion of fuel during daily temperature cycles.

The fuel cap has been updated to help the operator verify the cap is properly closed. This fuel system is engineered to vent through a carbon canister when the fuel cap is installed. This will greatly reduce fuel vapors that escape into the atmosphere and reduce the fuel odor that can be present with traditional systems.

The fuel system was factory-inspected and pressure-tested in accordance with regulations in effect at the time of manufacture. It is the responsibility of the boat owner to maintain the safe condition of the system. Inspect the system frequently to ensure no deterioration or loosening of connections has occurred.

NOTICE

Certain bulkhead areas are sealed in compliance with U.S. Coast Guard regulations at the date of manufacture. Any modifications must be made in accordance with the regulations.

3.2 Fuel System

WARNING

Failure to follow proper fuel system priming procedures will result in damage to fuel management system. The fuel system should be serviced by qualified personnel only. In the event of absolute fuel depletion to the engines, contact a certified Mercury Marine technician.

The outboard engines draw fuel from a single fuel tank. Use the fuel fill marked with a gasoline pump icon, located on the port gunwale, to fill the tank.

All boats equipped with gasoline engines are required by the U.S. Coast Guard to have anti-siphon valves. The fuel delivery lines are equipped with anti-siphon valves where the lines attach to the fuel tank. These valves help prevent gasoline from siphoning out of the fuel tank should a line rupture.

DO NOT remove the anti-siphon valves from the system. Anti-siphon valves prevent fuel from flowing into the bilge should a fuel hose or fitting leak. If the valve becomes clogged, clean and reinstall or replace it.

Fuel Tank

The fuel tank holds approximately 200 gallons (757 liters) of fuel. Fuel pick-up tubes are positioned in the tank to achieve optimum fuel usage, fuel line routing, etc. At certain speeds and hull trim angles, the fuel supply at the withdrawal tube can increase or decrease accordingly. Be extremely careful when attempting to operate the boat when low on fuel. Though some fuel may be in the tank, the trim angle of the boat may cause the fuel to flow away from the pickup tubes.

Fuel Gauge Senders

The fuel gauge senders are more accurate when the boat is stationary and level. Because of the change in attitude when the boat is underway, variations in gauge readings can occur. This system is a relative indication of the available fuel supply and not a calibrated instrument.

Fuel Fills

The gasoline fuel fill is located on the port gunwale and is marked with a gasoline pump icon.



Gasoline fuel fill



WARNING

Fuel is flammable. Do not smoke. Never fill the tank while the engines, blowers, generator, or other equipment is operating. Do not fill near open flames.

Fueling Instructions

1. Turn off all breakers on the AC and DC distribution panels, located in the port companionway upper electrical cabinet.
2. Make sure the generator is OFF.
3. Make sure your boat is securely moored.
4. Close all port lights, hatches, and doors.
5. Estimate how much fuel will be needed to fill the tank.



DANGER

FIRE/EXPLOSION HAZARD
Gasoline vapors are highly explosive when exposed to open flame or spark, resulting in death or serious injury.

- Stop engines before fueling.
- DO NOT smoke or allow open flames or sparks nearby, within 50 ft (15 m) of the fueling area.
- Maintain contact between fuel nozzle and fuel tank fill to prevent electrostatic spark. DO NOT use a plastic funnel.
- Fill in an open area.

 **DANGER**

BURN HAZARD
Ignited fuel floating on water can cause death or serious injury. Fuel will float on top of water and can burn. If the boat is abandoned, swim upwind, far enough to avoid fuel that can spread over the surface of the water.

 **WARNING**

Be sure that the fuel fill is in contact with the fuel nozzle to prevent any static sparks during the fueling operation. Failure to heed this warning could result in a static electricity charge that could lead to injury, damage, or death.

6. Open the fuel fill by turning it counter-clockwise.
7. Insert the fuel nozzle into the fuel fill and dispense the fuel until the tank is full. Verify that the tank is full by reading the fuel gauge and/or by the sound of the fuel fill filling up. If your tank takes significantly more fuel than expected, investigate the cause immediately.
8. After fueling, screw the cap on in a clockwise direction until an audible click is heard, indicating that the cap is seated. If the cap is lost or damaged, replace only with original equipment; contact Tiara Yachts Customer Relations or your Tiara Yachts dealer.
9. Wash the areas around the fuel fill(s) to help reduce discoloration of the fiberglass or striping. Use only the fuel recommended by the engine manufacturer. Refer to the engine owner’s manual for additional information.
10. Check the mechanical space and bilge areas for fuel odors. If you smell fuel, do not start the engines or other electrical equipment. Investigate and correct the problem, and completely ventilate the bilge area before proceeding.

During refueling, the tank will vent out at both the fuel fill plate and the vent located on the side of the hull. **Note:** There should not be any residual fuel at the vent but there could be residual fuel at the deck fill plate. Do not block or restrict either of these vents.

If fuel is accidentally added to any other tank, DO NOT attempt to pump the fuel out; these systems are not designed to pump fuel. Fuel must be removed by qualified personnel only. Fuel in other systems will also require replacement of that system and/or multiple components.

Try not to spill fuel. If fuel is spilled, wipe up all traces with dry rags and immediately dispose of the rags properly onshore. DO NOT allow fuel to stay on the finish of the boat, as discoloration and damage to trim can occur. Avoid fueling at night, except under well-lighted conditions. Also, monitor the fuel level to avoid overfilling.

 **WARNING**

The Federal Water Pollution Control Act prohibits the discharge of oil or oily waste into or upon the navigable waters of the United States, or the waters of the Contiguous Zone, or which may affect natural resources belonging to, appertaining to, or under the exclusive management authority of the United States, if such discharge causes a film or discoloration of the surface of the water or causes a sludge or emulsion beneath the surface of the water. Violators are subject to substantial civil penalties and/or criminal sanctions, including fines and imprisonment. Report all discharges to the USCG National Response Center at 1-800-424-8802 or to your local U.S. Coast Guard office by phone or VHF radio, Channel 16.

**WARNING**

Do not start the engines until you are sure there are no fuel fumes in the bilge or mechanical space of your boat. Fuel vapors are explosive and may ignite during engine start-up, causing serious injury or death.

**CAUTION**

To reduce the risk of fire, investigate all fuel odors immediately and do not start the engines, generator, or other electrical equipment if fuel odors are present.

**CAUTION**

A no-spill vent system is used so that fuel will not spill out of the vents when filling; however, fuel will exit the fuel fill pipe if overfilling occurs. When filling the fuel tank listen carefully for fuel filling up in the fill pipe.

**NOTICE**

To prevent damage to your fuel system, use only a quality grade of fuel as recommended by the engine manufacturer. Do not use a fuel which contains harsh additives. Damage to your fuel system as a result of using these fuels will not be covered by your warranty.

**NOTICE**

Be careful not to spill any fuel outside the boat into the water. If you do, clean up the fuel immediately in the manner prescribed by your local regulations.

Fuel Water Separating Filters

Fuel filters are located in the mechanical space. There is one water-separator type filter for each engine fuel line. Check all filters for water frequently to ensure an adequate supply of clean, dry fuel to the engines. The filter elements should be changed every 500 engine hours, at every other oil change, once a season, or if a power loss is noticed, whichever comes first.

Turn off all electrical switches before servicing the fuel system and DO NOT drain any fuel into the bilge. Prime the fuel system and check all fuel lines and fittings for leaks before and after starting the engines, and after any fuel system service. See the end of this section for more fuel system maintenance information.



*Gasoline fuel water separating filters
(typical)*

3.3 Diesel Generator Fuel System

If installed, the optional generator and 20-gallon diesel generator fuel tank are located in the mechanical space. The generator tank is filled through a deck fill marked DIESEL on the port gunwale.

Check the diesel fuel level using the gauge on the engine MFD at the helm, or the control panel on the generator. The fuel level may be read without starting the generator.

The diesel fuel system works much like the gas system. However, the diesel system isn't equipped with anti-siphon valves, and there is a fuel return line to return unused fuel to the fuel tank. The diesel system may require priming after servicing. Refer to the generator owner's manual for more information.

Make sure the fuel valve on top of the diesel tank is in the ON position before attempting to start the generator.

The generator water-separator fuel filter is installed on the starboard side of the mechanical space. The fuel filter has a sediment bowl that must be inspected for water frequently to ensure an adequate supply of clean, water-free fuel is supplied to the engine. Inspect the filter periodically and change the element as needed.



Diesel fuel fill

! **CAUTION**

DO NOT confuse the diesel and gas fuel fills; severe engine damage will result.

Diesel Generator Fueling Instructions

Try not to spill fuel. If fuel is spilled, wipe up all traces with dry rags and immediately dispose of the rags properly onshore. DO NOT allow fuel to stay on the finish of the boat, as discoloration and damage to trim can occur. Avoid fueling at night, except under well-

lighted conditions. Also, monitor the fuel level to avoid overfilling.

To fill the generator diesel fuel tank:

1. Turn off all breakers on the AC and DC distribution panels, located in the port companionway upper electrical cabinet.
2. Secure boat and remove all passengers.
3. Extinguish all flame-producing items.
4. Confirm the use of the correct fuel fill (diesel vs gas).
5. Open fuel fill by turning counterclockwise.
6. Put nozzle in the fuel fill opening.
7. The fuel delivery system will shut off when the tank is filled to the proper capacity.
8. Remove the nozzle. Install the fuel fill cap and turn clockwise, tightening until it clicks.
9. Check the fuel compartment and below the deck for fuel odors. If you smell fuel, DO NOT start the engines.



Generator water-separator fuel filter

**DANGER****FIRE/EXPLOSION HAZARD**

Gasoline vapors are highly explosive when exposed to open flame or spark, resulting in death or serious injury.

- Stop engines before fueling.
- **DO NOT** smoke or allow open flames or sparks nearby, within 50 ft (15 m) of the fueling area.
- Maintain contact between fuel nozzle and fuel tank fill to prevent electrostatic spark. **DO NOT** use a plastic funnel.
- Fill in an open area.

**DANGER****BURN HAZARD**

Fuel floating on water which is ignited can cause death or serious injury. Fuel will float on top of water and can burn. If the boat is abandoned, swim upwind, far enough to avoid fuel that can spread over the surface of the water.

**CAUTION**

Use only the fuel recommended by the engine manufacturer. The use of old, contaminated fuel can cause severe damage or engine malfunction. Do not use fuel that contains more than 10% ethanol, harsh additives or methanol; damage to the engines and fuel system will result. Fuel system damage, related to use of alcohol-blended fuels, is not covered by the Tiara Limited Warranty. Refer to the engine owner's manual for specific fuel requirements for your engines.

3.4 Fuel System Maintenance

Spray the valves, fuel tank gauge sender and ground connections with a metal protector.

Inspect the fuel fill cap o-ring seals frequently and lubricate with petroleum jelly or silicone grease. The o-ring seal prevents water from entering the fuel system through the fuel fill cap. If the o-ring is damaged, or you suspect it is damaged, replace it.

Old, degraded gasoline can affect engine performance and damage the engine and boat fuel system. Chemical changes occur as gasoline ages, reducing octane and causing deposits and varnish in the fuel system.

If your boat is not operated enough to require at least one full tank of fresh fuel a month, a fuel stabilizer should be added to the gasoline to protect the fuel from degrading. Do not allow the boat to sit unused for an extended period with the fuel tank less than 3/4 full. Changes in temperature and weather conditions can cause condensation in fuel tank. Your Tiara Yachts dealer or the engine manufacturer can provide additional information on fuel degrading and fuel stabilizers recommended for your engine.

**DANGER****FIRE / EXPLOSION HAZARD**

Fuels are extremely flammable and highly explosive under certain conditions. **DO NOT** smoke or allow open flames or sparks nearby when inspecting the fuel system. Check fuel lines and all system components (filters, primer bulbs, clamps and connections) frequently for leaks, damage or deterioration. If you suspect damage, replace as necessary. Surface cracking on a hose indicates wear—replace it.

Improper storage of fuel at marinas, limited boat usage, etc., can cause fuel to become contaminated. Periodically, it may be necessary to pump accumulating water and contaminated fuel from the bottom of the fuel tank. If the fuel system on your boat becomes contaminated, contact your dealer or marina for assistance.

Avoid using fuels with alcohol additives. Alcohol blend gasoline will absorb moisture from the air which can reach such concentrations that 'phase separation' can occur, where the water and alcohol mixture becomes heavy enough to settle out of the gasoline to the bottom of the tank. Since the fuel pickup tubes are near the bottom of the tank, phase separation can cause the engine to run very poorly or not at all. Phase separation is more severe with methyl alcohol and will increase as the alcohol content increases. Water or a jelly-like substance in the fuel filters is an indication of phase separation from the use of alcohol-blended fuels.

Diesel engine operation requires a good supply of clean, water-free diesel fuel. Algae can grow in the accumulated water in the diesel fuel tank. This will normally occur in warm climates. Adding a high-quality diesel fuel additive containing an algaecide may be required periodically to control algae in your diesel system, depending on your boating area. Contact your Tiara Yachts dealer or engine manufacturer for additional information regarding fuels and additives.

Electrical Systems

4.1 General

The electrical systems in your Tiara Yacht have been developed to supply all the boat’s electrical needs at the dock, at anchor, and underway. While this manual will not attempt to describe all of the electrical engineering that went into the system, a basic understanding will help assure trouble-free operation.

Your boat is equipped with DC and AC electrical systems. The DC system draws current from onboard batteries. The AC system can draw current from either dockside (shore power) outlets or the generator.

Electrical schematics are included in Appendix F to assist technicians in the servicing of the electrical systems. Tiara recommends you take your boat to an authorized Tiara Yachts dealer for service or installation of additional electrical equipment. Tiara reserves the right to modify or update the electrical system at any time without notice to the consumer or obligation to make updates to boats built prior to the change.

WARNING

All electric system service work should be performed only by an authorized Tiara Yachts dealer or other qualified marine electrical service facility. Failure to heed this warning may result in personal injury or death.

4.2 12-Volt DC System

Power Supply

Five 12-volt batteries have been selected to provide optimum performance for engine starting and house loads. Boats equipped with an optional gyro are outfitted with two additional batteries. The batteries are located

in the mechanical space. Refer to the engine owner’s manual for information about the circuit breakers installed on your engines.

The house battery bank supplies power to all the boat’s comfort and convenience functions such as lighting, pumps, actuators, stereo, and electronics, as well as the bow thruster. The house bank should also be used to power any aftermarket electronics.

CAUTION

All aftermarket electrical components should be installed by your Tiara Yachts dealer or other qualified marine electrical service facility. They must be installed to be powered from the house battery bank only. The engine battery banks are strictly reserved for engine power only.

Battery Charging

The 12-volt DC system batteries are charged by the engine charging system or by the battery charger when connected to shore power or operating the generator.



Battery chargers (typical)

Your boat is equipped with two battery chargers. The 40 amp charger (60 amp if the boat is equipped with an optional gyro) charges the house batteries, and the 20 amp charger charges the engine batteries. Both chargers are calibrated to provide the proper charge levels for each specific battery. Changing the

battery specification will require recalibration of the battery chargers. The battery chargers are located in the mechanical space.

It is important that your batteries be kept in a state of full charge as much as possible. Fully charged 12V batteries will indicate a voltage in excess of 12.6 volts with no load, or while being charged. Consult the DC voltmeter on the DC distribution panel (in the port companionway upper electrical cabinet) or the helm MFD to check battery voltage.

Prolonged periods of discharge will cause the batteries to deteriorate rapidly, and will result in their inability to hold a charge for the expected amount of time. This can happen easily if excessive DC loads (such as lights) are left on while the battery charger is off.

At dockside, when the boat is connected to shore power, the battery chargers maintain the charge on the engine and house batteries. When operating the generator, the engine and house battery chargers must be on to maintain charge to the batteries.

Leave your boat connected to shore power with the battery chargers ON when leaving for any extended period of time. To do so, be sure the BATTERY CHARGER switches on both the Master DC Panel (in the mechanical space) and the AC distribution panel (in the port companionway upper electrical cabinet) are ON.

Automatic Charging Relay (ACR)

Your Tiara Yacht is equipped with an automatic charging relay (ACR). The ACR box is located inside the Master DC box in the mechanical space.

The ACR automatically parallels (combines) battery banks during charging, and isolates them when charging has stopped and battery voltage has fallen. The ACR allows temporary isolation of house loads from the engine circuit during engine cranking, in order to protect sensitive electronics. It is intended to keep a load from discharging both of the battery

banks. The LED light on the ACR box indicates when batteries are combined. See the automatic charging relay owner's manual for more information.



Automatic charging relay box (typical)

DC Distribution

Power from each engine battery supplies the respective red engine battery switch--STBD, CENTER (if applicable), and PORT--on the Master DC Panel, located in the mechanical space. A circuit breaker on each engine protects the engine ignition systems and gauges. Refer to the engine owner's manual for information about your engines. The red main engine battery switches may be controlled remotely by the PORT BATTERY, CENTER BATTERY (if applicable), and STBD BATTERY buttons on the DC distribution panel, located in the port companionway upper electrical cabinet.

Power from the house batteries supplies the red HOUSE battery switch, which may be controlled remotely by the HOUSE BATTERY button on the DC distribution panel. Battery switches and breakers on the DC distribution panel protect the switch panels on the helm.

When the Master DC Panel red main battery switches are in the OFF position, all DC power to the rest of the boat (including the high water alarm) is disconnected. **The only exceptions** are the forward, mid, and aft automatic bilge pumps and the shower sump box. Shutting OFF the red main battery switches will not disconnect power to bilge pumps.

4.3 Master DC Panel Breakers

There are a number of breakers on the Master DC Panel, located in the mechanical space, that need to be switched ON for their corresponding components to operate.

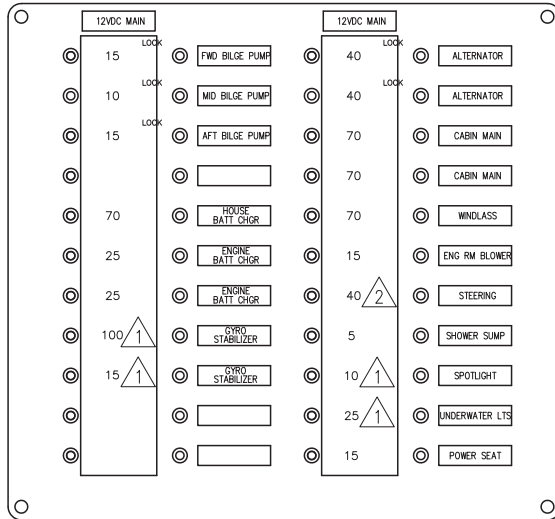

△1 OPTIONAL
 △2 OPTIONAL: NON HELM MASTER ONLY

Master DC Panel schematic

Bilge Fwd: Supplies power to the forward bilge pump located under the cabin sole hatch.

Bilge Mid: Supplies power to the mid bilge pump located in the forward mechanical space.

Bilge Aft: Supplies power to the aft bilge pump located in the aft mechanical space.

Battery Chargers: Supplies power to the house and engine battery chargers.

Gyro Stabilizer (optional): Supplies power to the Seakeeper gyro stabilizer, if installed.

Alternator: Provides circuit protection for individual engine alternators that charge the house batteries. These switches should remain ON.

Cabin Main: Supplies power to the DC distribution panel.

Windlass: Supplies power to the windlass. Turn off the breaker when the windlass is not in use to reduce the possibility of accidentally activating the windlass.

Eng Room Fans: Supplies power to the exhaust blower in the mechanical space.

Steering (optional): Supplies power to the Helm Master steering pumps, if installed.

Shower Sump: Supplies power to the shower sump motor. See section 5, Plumbing Systems, for details.

Spotlight (optional): Supplies power to the spotlight control panel at the helm (if installed).

Underwater Lights (optional): Supplies power to the UNDERWATER LIGHTS helm button. Use these lights only when the boat is in the water since they rely on water for cooling.

Helm Seat: Supplies power to the helm Seat Aft/Fwd switch.

12-Volt DC Helm Switches

There are a number of switches on the helm. For any of the switches to function, the corresponding circuit breaker on the DC distribution panel, located in the port companionway upper electrical cabinet, must be switched ON.

Horn: Activates the boat horn.

Underwater Lights: Activates the underwater lights. Use these lights only when the boat is in the water since they rely on water for cooling.

Hardtop Wht Lts: Activates the white lights mounted underneath the hardtop.

Hardtop Red Lts: Activates the red lights mounted underneath the hardtop. For use when navigating at night.

Washer: Activates the windshield washer. The WATER PUMP breaker on the DC distribution panel must be ON.

Wiper On/Off: Activates the windshield wiper.

Wiper Hi/Lo: Selects high (fast) or low (slow) windshield wiper speed.

Seat Aft/Fwd: Moves the helm seat forward or aft.

Sunshade Open/Close: Opens or closes the optional aft cockpit sunshade, if installed.

Windlass Deploy/Retrieve: Deploys and retrieves the anchor. Refer to the windlass information in section 7, Exterior Equipment.

Nav Lights: Activates the red and green navigation (or ‘running’) lights and the all-around light on the masthead. Use when operating the boat at night or when visibility is reduced.

CAUTION

Always make sure the aft navigation light is visible. Never obstruct or block the visibility of any of the navigation (NAV) lights.

Anc Light: Activates the all-around anchor light on the masthead. Use this light when the boat is at anchor at night.

Aft Bilge, Mid Bilge, and Fwd Bilge: Activates the respective aft, mid, and forward bilge pumps. See section 5, Plumbing Systems, for pump locations. If a pump activates automatically, the corresponding bilge pump button will light up.

Blower: Activates the mechanical space exhaust blower.

ACC: Unassigned and reserved for user-installed accessories. DO NOT install a component with an operating current that exceeds 10 amps (12V DC).

4.4 DC Distribution Panel

DC Volt Meter

Periodically monitor the voltage (charge) on your batteries. To do so, use the METER SELECT switch on the DC distribution panel to determine which battery to monitor. The voltage for the selected battery will register on the volt meter. Do not operate the DC system if the voltage is lower than 105v or higher than 130v.

DC Breakers

The breakers on the DC distribution panel, located in the port companionway upper electrical cabinet, must be switched ON for the corresponding components to function.

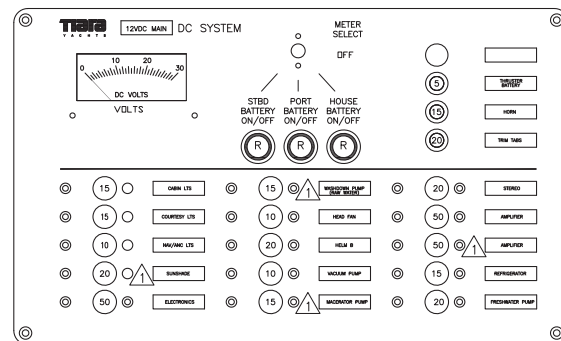

OPTIONAL

DC distribution panel schematic

Cabin Lights: Supplies power to cabin light switches.

Courtesy Lights: Supplies power to switches that control the hardtop flood lights.

Nav/Anc Lights: Supplies power to the NAV and ANC LIGHTS helm buttons.

Sun Shade (optional): Supplies power to the SUNSHADE helm button.

Electronics: Supplies power to the electronics at the helm.

Washdown Pump (optional): Supplies power to the optional pressure-demand raw water washdown pump, if installed. The pump is also protected by an automatically resetting breaker on the pump motor. Refer to section 5, Plumbing Systems, for more information.

Head Fan: Supplies power to the head exhaust fan motor.

Helm B: Supplies power to the WIPER, SEAT, WINDLASS, and WASHER helm buttons.

Vacuum Pump: Provides power to the head vacuum flush pump. Must be switched ON in order for the head vacuum flush to function.

Waste Pumpout: Supplies power to the overboard waste discharge pump. This breaker should be kept OFF at all times unless pumping waste overboard in a legal raw sewage discharge area. See section 5, Plumbing Systems, for more information.

Stereo: Provides power to the stereo and, if installed, the optional stereo remote units in the aft and forward lounges.

Amplifier: Provides power to the stereo amplifier(s).

Refrigerator: Supplies power to the mid-cockpit galley refrigerator(s).

Fresh Water Pump: Supplies power to the fresh water pump. Must be turned ON in order to use the shower, sinks, head, wind-shield washer, and other freshwater system components. Turn OFF when the boat is unattended.

Thruster Battery: Supplies power to the bow thruster control.

Horn: Supplies power to the helm HORN button.

Trim Tabs: Supplies power to the Lenco® trim tab panel on the helm.

4.5 Seakeeper Gyro (optional)

If your boat is equipped with the optional Seakeeper® gyro, be sure to become familiar with the gyro low voltage alarm. Refer to the Seakeeper owners manual for more information.

In situations where there is a net discharge on the house battery bank (i.e. engines off), the Seakeeper – which continually monitors battery voltage – will run at full power until it detects 11.1 VDC at the Seakeeper. At this level, which reflects approximately 11.3-11.5 VDC at the battery bank, the gyro will begin incrementally decreasing its power consumption to ensure that its measured voltage does not decrease below 11.0 VDC.

During this decrease in power consumption, if the measured voltage at the Seakeeper does not increase above 11.1 VDC, then the Seakeeper will continue to de-rate power consumption until it reaches 67% of its flywheel target speed. At this point, an alarm will trigger and the Seakeeper will shut itself down.

Seakeeper Display Low Voltage Alarm

If, before the 67% flywheel speed automatic shutdown is triggered, a net charge is fed back into the battery bank (i.e. engines have been started) and the voltage at the Seakeeper is raised above 11.1 VDC, the Seakeeper will detect this and begin incrementally increasing its power consumption once again, until it resumes full-speed stabilization.

If the system voltage is raised after the 67% flywheel speed automatic shutdown is triggered, the user will need to manually restart the Seakeeper to resume stabilization.

4.6 AC System

Either shore power or generator power may be used to supply AC current to the AC distribution panel, located in the port companionway upper electrical cabinet. All AC current is distributed to AC components through individual 120V (230V for CE) circuit breakers located on the AC distribution panel.

The power selector breakers in the AC distribution panel are equipped with a selector slide to prevent the shore power source and the generator source from being energized simultaneously and damaging the electrical system components. Refer to further information about shore and generator power later in this section.

DANGER

ELECTROCUTION, FIRE, OR EXPLOSION HAZARD

Contact with live wires or working on an energized electrical system can cause electrocution. It can also cause sparks, resulting in fire and/or explosion. Both cases will result in death or serious injury. DO NOT work on an energized system or allow unqualified personnel to work on the system.

Isolation Transformer

The AC electrical system operates on a 120 volt, 30 amp, 60 Hz system. The AC system is fed by shore power or by the generator. An isolation transformer maintains correct AC polarity regardless of the polarity of the shore power supply, and eliminates the need for a galvanic isolation system and reverse polarity indicator.

If the isolation transformer causes the shore power breaker on the AC panel to trip, reset the breaker. If it trips a second time, contact the dock master or a qualified marine electrician. Refer to the isolation transformer manual for additional information.

4.7 AC Distribution Panel

The AC distribution panel is located in the port companionway upper electrical cabinet.

AC Voltmeter

Monitor the available AC voltage periodically, in order to detect abnormal operating conditions early. To check the voltage, consult the voltmeter on the AC distribution panel or the helm multi-function display (MFD). The voltmeter will indicate the current voltage of the power source (shore power or generator) and the load currently being applied to that source. If the voltage being supplied while using the 120V-30A connection is lower than 105V or higher than 130V, discontinue use and correct the problem as soon as possible.

AC Main Breakers

The shore power (SHOREPOWER) and generator (GEN) main breakers protect the AC distribution system. These breakers are very sensitive. The resulting power surge that occurs when connecting the dockside cord or starting the generator may cause the main breaker to trip. To avoid this surge, always turn the breakers to the OFF position before plugging or unplugging the shore power cord or starting or stopping the generator.

The breakers on the AC distribution panel need to be switched ON for their corresponding components to operate:

Battery Charger: Supply power to the battery chargers, which maintain the charge on the engine and house batteries. These breakers should ALWAYS be ON when shore power is connected or the generator is operating. The battery chargers, located in the mechanical space, are equipped with an ammeter to monitor charging. See the battery charger owner's manual for more information.

Water Heater (optional): Supplies electrical current to the water heater, if installed. The water temperature is automatically con-

trolled by the temperature valve on the water heater. Do NOT turn this breaker ON without having water in the water heater. See section 5, Plumbing Systems, and the water heater owner's manual for more information.

Outlets: Supply electrical current to the boat's electrical outlets and protect against short circuits and overloads. AC electrical outlets are provided with ground fault interrupters (GFI) to protect against electric shock. To ensure proper operation, these outlets should be tested periodically by pressing the test/reset buttons in the center of the face plate. The GFI outlets themselves do not protect against short circuits and overloads. **NOTE:** GFI outlets do not provide 100% protection from electric shock. While ground fault interrupters reduce exposure time from line to ground shock hazards, it is still possible to receive a shock from defective appliances or power tools and misused electrical equipment.

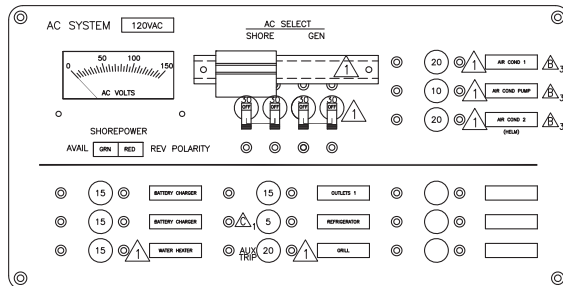

OPTIONAL

AC distribution panel schematic

Cockpit Refrig: Supplies electrical current to the mid-cockpit galley refrigerator(s).

Deck Grill (optional): Supplies electrical current to the mid-cockpit galley grill, if installed. This breaker should be on ONLY when the grill is being used. See the grill owner's manual for more information.

Air Cond 1 and 2 (optional) breakers: Supply power to the air conditioning unit(s). The AIR COND PUMP breaker must be turned ON to operate the air conditioning. See section 6,

Ventilation Systems, for climate control panel locations. Refer to the air conditioner user manual for additional information.

Air Cond Pump: Supplies electrical current to the air conditioner pump. This breaker must be ON in order to use the air conditioning unit(s).

4.8 Other Electrical Controls

The port companionway upper electrical cabinet houses the climate controls for the helm and cabin, and the waste holding and water tank monitors.

The port companionway lower electrical cabinet houses the remote generator control panel (if installed); the bilge alert high water alarm and power/test button; outlets; and a stereo auxiliary port.

4.9 Shore Power Connection

The shore power system is designed to be connected to one or two 120V/30A dockside outlets. Before every use, check the shore power cord(s) for cracks and chafing of the insulation, and check cord terminals for corrosion or heat damage.

To connect to shore power:

1. Turn OFF the main shore power breaker(s) on the AC distribution panel. Turn off dockside outlet disconnect switch(es) or circuit breaker(s), if present.
2. The shore power inlet is installed on the aft face of the port side boarding steps. Unscrew the inlet cover and plug the cord in. To avoid strain on the cable, make sure it has more slack than the mooring lines. Position the cable so that it cannot be damaged by chafing between the boat and the dock. Make sure the cable does not come in contact with the water.



Shore power inlet

3. Connect the cable to the dockside outlet. Tighten the lock rings on both the shore and the boat connector plugs.
4. Turn the dockside disconnect switch(es) or circuit breaker(s) to the ON position.
5. Check the shore power indicator lights on the AC distribution panel. **Note:** If the red light is illuminated, do not proceed. Turn OFF all breakers and contact marina personnel immediately.
6. Switch ON the SHORE AC select breaker(s) on the AC distribution panel.

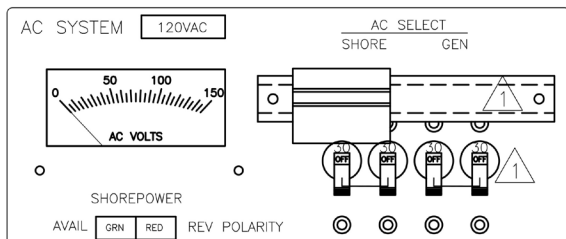

Detail of AC distribution panel schematic: shore power and generator power AC select switch and polarity indicator lights

DANGER

ELECTROCUTION HAZARD

Exposure to high voltage will cause death or serious injury. DO NOT attempt to correct wiring yourself. DO NOT swim in marinas or near boats connected to shore power. Keep children away from any electrical cables or equipment and use only grounded appliances onboard.

CAUTION

When routing electric cables and dockside water hoses to the dock, be sure to allow sufficient slack so the cables and hoses will not be strained in any way as the boat moves within its slip. Do not allow cables or hoses to dangle into the water.

WARNING

Do not make connections in wet weather, with wet hands, or with wet cables and connections. Always use a 3-wire electrical system connected to a ground. Do not use worn or damaged cables. Failure to heed this warning can result in an electrical shock injury or death.

Disconnecting from Shore Power

Turn OFF the AC select SHORE breaker(s) on the AC distribution panel. If the dockside outlet(s) includes a disconnect switch(es) or circuit breaker(s), turn them to the OFF position. Disconnect the cable from the dockside outlet(s) and replace the outlet caps. Return the cable to the boat, disconnect from inlet, and store.

4.10 Generator (optional)

If installed, the diesel generator is located in an enclosure in the mechanical space. Fuel-injected generators require bleeding of air from the fuel delivery system prior to initial start-up, and if the generator is allowed to run out of fuel. Continued attempts to start the generator without bleeding the fuel system under these circumstances can lead to engine damage or erratic operation. This procedure must be completed by your Tiara dealer.

**WARNING**

Do not start the generator until you are sure there are no fuel fumes in the bilge or mechanical space. Fuel vapors are explosive and may ignite during generator start-up, causing serious injury or death.

**CAUTION**

To reduce the risk of fire, investigate all fuel odors immediately and do not start the engines, generator, or other electrical equipment if fuel odors are present.

**CAUTION**

Before starting the generator, ensure the fuel supply and return valves are open. A fuel valve is open when it is parallel to its associated fitting. Failure to open all fuel valves will damage the generator.

**CAUTION**

DO NOT start the generator with the AC distribution panel power selector switch in the GENERATOR position. Allow the generator to warm-up three to four minutes before transferring the electrical load. After warm-up, place switch in GENERATOR position.

The generator is equipped with an automated start-up sequence to prevent over-cranking (which can lead to engine damage) and to ensure that the generator is up to operating temperature before the electrical load is applied. The display on the remote generator control panel, in the port companionway lower electrical cabinet, provides detailed information on the operating status of the

generator. Refer to the generator owner's manual for instructions on operation and interpretation of the displayed data.

**CAUTION**

If the generator fails to start after 60 seconds of cranking, cease operation. Before attempting to crank again, drain the water from the generator's muffler. Failure to do so could result in raw water contamination of the generator's cylinders and damage the engine(s).

**NOTICE**

DO NOT allow the generator to run out of fuel. Fuel injected generators require air to be removed from the fuel delivery system before initial start-up or if the generator is allowed to run out of fuel. Continued attempts to start the generator with air in the fuel system can lead to engine damage or erratic operation. Air must be purged by your servicing dealer only.

To start the generator:

1. Open all hatches to the bilge area. Investigate and remedy any fuel vapors that are detected.
2. Check the generator oil and coolant levels.
3. Open the generator raw water seacock.
4. Open the diesel fuel supply valve. The fuel valve is located on the fuel tank in the starboard aft mechanical space.
5. Switch OFF the main breakers labeled SHORE & GEN on the AC distribution panel (located in the port companionway upper electrical cabinet).
6. Switch ON all breakers except the OIL CHANGE PUMP breaker (if installed) on the Master DC Panel in the mechanical space.

7. Switch ON the main battery switches—PORT BATTERY, STBD BATTERY, and HOUSE BATTERY—on the DC distribution panel (located in the port companionway upper electrical cabinet).
8. Turn ON the BLOWER button at the helm. Run the blower for five minutes prior to starting the generator.
9. Press and hold the START button on the generator control panel or the remote control panel (located in the port companionway lower electrical cabinet) until the generator starts. The generator status light will blink and the display will read 'STARTING' while the engine is preheating and cranking. The generator status light will stay on and the display will read 'RUNNING' once the generator starts and is running.
10. Switch ON the AC SELECT GEN breaker on the AC distribution panel. The boat's AC system is now being powered by the generator.

To stop the generator:

1. Switch OFF the AC SELECT SHORE & GEN breakers on the AC distribution panel.
2. Allow the generator to run for two minutes without load to cool down.
3. Press and release the STOP button on the remote generator control panel or the panel on the generator.



Remote generator control panel (typical)

It is important to activate the house battery charger to maintain the house batteries whenever the generator is running. Because of the number of DC systems on this boat, a significant drain on the batteries can occur. Depending on the RPM and the duration of operation of the engines, the engines' charging systems may not be able to keep up with the DC electrical demand, particularly when the engines are run at low RPM for extended periods. To ensure that the batteries remain at peak charge, Tiara strongly recommends that the generator be run whenever the boat is in use and not connected to shore power.

4.11 Electrical System Maintenance

DC Electrical System Maintenance

At least semi-annually, spray all exposed electrical components behind the helm and in the plugs with a protector specific for electrical connections.

Make sure to check that all below-deck wiring is properly supported, the insulation is sound, and there are no loose or corroded terminals. Clean any corroded terminals thoroughly with sandpaper, or replace them. Tighten securely and spray with a metal and electrical protector. Inspect all engine wiring.

Check the electrolyte level in the batteries regularly and add distilled water as necessary. If the batteries are frequently charged by a battery charger, check the electrolyte level more often. The correct fluid level in the cells is approximately 1/4 to 1/2 inch above the plates. If fluid is needed, fill to the proper level with distilled water ONLY. DO NOT overfill. Some batteries are sealed and cannot be filled.

Keep the tops of any battery clean and dry. Dirt and water can conduct electricity from one post to the other and can cause battery discharge or engine warnings.

**DANGER****FIRE OR EXPLOSION HAZARD**

Explosion or fire from hydrogen gases produced by lead acid batteries will cause death or serious injury. DO NOT smoke or bring a flame near the battery storage area. If ignited by a spark or flame, gas may explode violently, causing spraying of battery acid or fragmentation of the battery.

- DO NOT work on an energized system; make sure all power sources are off.
- DO NOT allow unqualified personnel to perform electrical maintenance; only a qualified marine electrician should work on the electrical system.
- DO NOT work in a wet area.
- Use caution when connecting wires, in order to avoid reversing polarity.
- DO NOT alter wires or connectors, or use inferior parts. Use OEM replacement parts only.

Keep the battery posts free of corrosion. DO NOT use wing nuts to attach battery cables. Remove the cables and clean the posts and cable clamps with a battery post cleaner or sandpaper as required. Coating the battery posts and cable clamps with petroleum jelly or silicone grease will help protect them and reduce corrosion. Battery cables, both positive and ground, must be replaced when they show signs of corrosion or fraying. Deteriorated cables cause a considerable voltage loss when high currents are drawn, such as when starting the engine. See the battery owner's manual for maintenance information.

AC Electrical System Maintenance

Inspect all wiring insulation for nicks, chafing, brittleness, improper support, etc., periodically. Inspect portable appliance cords and plugs.

Examine the shore power cord for cracks in the insulation and corrosion in electrical connectors. Spray receptacles and electrical connections with an electrical contact cleaner or a metal and electrical protector to help reduce corrosion and improve electrical continuity.

General Precautions

- Whenever possible, have electrical work done by a qualified electrician or your Tiara Yachts dealer.

**DANGER****ELECTROCUTION, FIRE, OR EXPLOSION HAZARD**

Contact with live wires or working on an energized electrical system will cause electrocution. It can also cause sparks, resulting in fire and/or explosion. Both cases will result in death or serious injury. DO NOT work on an energized system or allow unqualified personnel to work on the system.

Corrosion on the electrical connectors can cause poor connections, shorts and ground faults, and/or poor ground connections. Check at least annually and clean as required. DO NOT allow corrosion to build on connections.

Inspect all terminals and make sure they are tight.

Have the entire AC circuitry and the shore power cord tested every season by an experienced marine electrician. This will detect any shorts, open wires, or ground faults. Also, have the polarity indicator system inspected for proper operation.

Test all outlets periodically by pressing the test/reset buttons in the center of the face plate to ensure proper operation.

The engine maintenance required on the generator is similar to that required for the main engines. The most important factors affecting the generator's longevity are proper ventilation and the maintenance of the AC alternator and the fuel, ignition, cooling and lubrication systems. Maintenance schedules and procedures are outlined in your generator owner's manual; follow them exactly.

Plumbing Systems

5.1 Freshwater System

The freshwater system consists of two potable water tanks, distribution lines, and a distribution pump. The pump is equipped with an automatic pressure switch.



Fresh water pump, in the mechanical space



Water tank(s) deck fill

The tanks are filled through the labeled deck fill on the starboard gunwale.

Operation

DO NOT confuse other deck fills with the freshwater fill. If toxic fluids or fuel is added to a freshwater tank, the system will be contaminated. DO NOT attempt to pump fuel out; this system is not designed to pump fuel. Fuel must be removed by qualified personnel only. Fuel in the freshwater systems will also require replacement of that system and/or many components.

! DANGER

FIRE OR EXPLOSION HAZARD
 Fuel and their vapors are highly explosive when exposed to open flame or spark, resulting in death or serious injury. Do not confuse deck fills.

! WARNING

HEALTH HAZARD
 Disinfect the entire fresh (potable) water system prior to first use, and annually at the beginning of each season. Failure to do so can result in developing coliform bacteria or other disease-causing organisms (pathogens) in the water system. Consumption of contaminated water could result in severe personal injury or death.

! CAUTION

When routing electric cables and dockside water hoses from the boat to the dock, be sure to allow sufficient slack so cables and hoses will not be strained in any way as the boat moves within its slip. Do not allow cables or hoses to dangle into the water.

Follow the instructions in section 5.2, Freshwater System Commissioning, to disinfect the system at the beginning of each season. Once the system is commissioned, to refill the water supply tank(s), use a dockside hose and fill the tank(s) slowly through the freshwater fill. The tanks should be filled until water runs out of the vent located on the hull side just below the fill. After filling the tank(s), partially open all faucets. Switch ON the FRESH WATER PUMP switch on the DC distribution panel, located in the port companionway upper electrical cabinet. Allow the

pump to run until all of the air is purged from the system and a steady stream of water is flowing from each outlet. Next, turn off the faucets one by one. As the pressure builds, the pump will automatically shut off.

When properly primed and activated, the water system will operate like the water system in a home. An automatic pressure sensor keeps the system pressurized. If the system has been recently filled or has not been used for an extended period, air may accumulate at the pump and the system may have to be re-primed.

Whenever the boat is left unattended, turn the FRESH WATER PUMP switch OFF.



CAUTION

DO NOT allow the fresh water pump to run dry; damage to the pump can occur. The fresh water pump works on demand and WILL NOT shut off when the tank is empty. Turn the water pump switch OFF when the system is not in use. Operating any pump from a low-charged battery can lead to a pump failure. Keep the batteries properly charged. The fresh water system must be properly winterized prior to winter lay-up. Refer to winterizing directions in section 12, Seasonal Maintenance.

Sink and Shower Operation

To use the sink(s) or shower, switch ON the FRESH WATER PUMP switch on the DC distribution panel. Some minor variations in the water temperature and pressure may occur as the pump cycles.

The sink(s) drain overboard. Shower water drains to a sump pump system located in the bilge below the cabin floor. An automatic float switch in the shower sump controls the pump. After showering, let the cold water flow for a period of time to flush the drainage system of soap residue. The shower drain strainer

should be cleaned regularly and the sump inspected periodically for accumulated debris that needs to be removed.

Water Heater (optional)

If installed, the optional water heater is located in the mechanical space. The water heater uses an AC element that is thermostatically controlled at the heater. A high pressure relief valve protects the system from excessive pressure.



Water heater (optional)

To use the water heater, the WATER HEATER breaker on the AC distribution panel (installed in the port companionway upper electrical cabinet) must be ON. Make sure all air is purged from the water heater and lines before activating the water heater breaker. Refer to the water heater manual for additional information.



CAUTION

DO NOT turn on the water heater until it is filled and primed; damage to the heater will result.

5.2 Freshwater System Commissioning

The freshwater system must be disinfected before first use, and annually at the beginning of each season. A clean, sanitized freshwater system will greatly reduce the risk of developing coliform bacteria or other disease-causing

organisms (pathogens), and will help protect the health of everyone onboard.

WARNING

HEALTH HAZARD

Disinfect the entire fresh (potable) water system prior to first use and annually at the beginning of each season. Failure to do so can result in developing coliform bacteria or other disease-causing organisms (pathogens) in the water system. Consumption of contaminated water could result in severe personal injury or death.

CAUTION

Notify all persons aboard that the fresh water system is being sanitized. Do not allow anyone to drink from the fresh water system during the sanitizing process.

To drain the system of antifreeze (if used):

1. Open all sink and shower faucets (hot & cold). Set single faucets to the warm position.
2. Switch ON the FRESH WATER PUMP breaker(s), located on the DC distribution panel (installed in the port companionway upper electrical cabinet). The pump is self-priming.
3. When anti-freeze stops flowing out of the faucets, switch the pump breaker OFF. Do not close faucets.
4. Fill the freshwater tank(s) with clean, fresh water using the deck fill fitting labeled WATER. The tank(s) should be filled until water runs out of the vent located on the hull side just below the fill.
5. Keeping all faucets open, switch ON the freshwater pump breaker and empty the water tank(s). When the water tank(s) is empty turn the pump breaker(s) OFF.

6. Repeat steps 4 and 5 until all nontoxic potable water antifreeze is removed from the system.

To disinfect and commission the fresh-water system:

1. Ensure the water system, including the water heater and pump, is drained completely. If the system was filled with nontoxic antifreeze before storage, drain it following the instructions provided previously.
2. Close all faucets.
3. Prepare a chlorine sanitizing solution of 1/4 cup of Clorox® or Purex® regular unscented household bleach (5% sodium hypochlorite solution) for each 15 gallons of water tank(s) capacity.

<i>Tank capacity vs. cups of bleach</i>	
Water Tank Capacity	Cups of Bleach
15 gallons	1/4 cup
30 gallons	1/2 cup
45 gallons	3/4 cup
60 gallons	1 cup
75 gallons	1-1/4 cups
90 gallons	1-1/2 cups
105 gallons	1-3/4 cups
120 gallons	2 cups
135 gallons	2-1/4 cups
150 gallons	2-1/2 cups

4. Fill the freshwater tank(s) halfway with clean, fresh water.
5. Pour the bleach into the water tank(s) through the deck WATER fill fitting.
6. Fill the freshwater tank(s) with clean, fresh water using the deck fill fitting labeled WATER. The tank(s) should be filled until water runs out of the vent located on the hull side just below the fill.
7. Switch ON the FRESH WATER PUMP

- breaker(s).
8. At each faucet, run about 1/2 gallon of water out of each tap (hot and cold), then close the tap. You should be able to smell chlorine out of each tap.
 9. Switch OFF the FRESH WATER PUMP breaker(s) on the DC distribution panel, located in the port companionway upper electrical cabinet.
 - 10. Allow the chlorine sanitizing solution to sit in the system for three (3) hours.** A shorter time period will require a greater concentration of chlorine sanitizing solution to disinfect the water system.
 11. Switch ON the FRESH WATER PUMP breaker(s).
 12. Drain the chlorine sanitizing solution: open all faucets (hot & cold), set single faucets to the warm position, and empty the water tank(s). Ensure the water system, including the water heater and pump, is drained completely. When the water tank(s) is empty turn the pump breaker(s) OFF.
 13. Fill the freshwater tank(s) with clean, fresh water using the deck fill fitting labeled WATER. The tank(s) should be filled until water runs out of the vent located on the hull side just below the fill.
 14. Keeping all faucets open, switch ON the FRESH WATER pump breaker(s) and empty the water tank(s). When the water tank(s) is empty turn the pump breaker(s) OFF.
 15. Fill the tanks again, until water runs out of the vent. Switch ON the FRESH WATER pump breaker and empty the tanks. Switch the breaker OFF.
 16. Final fill: Fill the freshwater tank(s) with clean, fresh water. The tank(s) should be filled until water runs out of the vent on the hull side just below the WATER fill.
 17. Switch ON the FRESH WATER PUMP breaker(s) and open all faucets. When a smooth flow of water is observed from each hot and cold tap, close the faucet. When all faucets are closed, the pump(s) will shut off as the system

pressure increases. Any air should now be purged from the system.

The freshwater system is now commissioned and ready for use.

To remove excessive chlorine taste or odor that might remain in the system, do the following:

1. Ensure the water tank(s) has enough available capacity to accept 10 additional gallons. If there is ample room in the tank(s), proceed to step 3, below. If not, continue to step 2.
2. Drain at least 10 gallons of water from the system to make room for the vinegar solution (step 3). To do this, switch ON the FRESH WATER PUMP breaker(s) on the DC distribution panel, located in the port companionway upper electrical cabinet, and open a faucet. When at least 10 gallons have been drained, close the faucet and turn the pump breaker OFF.
3. Prepare a solution of one (1) quart vinegar to five (5) gallons fresh water.
4. Pour the vinegar solution into the water tank(s) through the deck WATER fill fitting.
5. Allow the vinegar solution to agitate in the tank(s) for 24 hours.
6. Switch ON the freshwater pump breaker and drain the vinegar solution by opening all faucets (hot & cold), setting single faucets to the warm position, and empty the water tank(s). When the water tank(s) is empty turn the pump breaker(s) OFF.
7. Close all faucets.
8. Fill the freshwater tank(s) with clean, fresh water using the deck fill fitting labeled WATER. The tank(s) should be filled until water runs out of the vent located on the hull side just below the fill.
9. Switch ON the freshwater pump breaker(s) and open each faucet. When water flows smoothly from the hot and cold tap, close the faucet. When all faucets are closed, the pump will shut off as

the system pressure increases. Any air should now be purged from the system.
10. Repeat if necessary.

5.3 Marine Head System

Your boat is equipped with a VacuFlush® marine head system. This system uses a small amount of water and a vacuum, which is powered by a 12-volt vacuum pump, to flush. The toilet is connected to the pressurized freshwater system. Fresh water is used to reduce odor in the head compartment.

Before using the toilet, switch ON the VACUUM PUMP and FRESH WATER PUMP breakers on the DC distribution panel (located in the port companionway upper electrical cabinet). To use the toilet, lift the foot flush lever slightly to wet the bowl with the desired water level. Depress the flush lever all the way for approximately three seconds or until the bowl is clear. A sharp popping noise is normal when the vacuum seal is broken and flushing action begins. It is also normal for a small amount of water to remain in the bowl after flushing.

The waste is directed to the holding tank, located in the mechanical space, until it is pumped out by a waste dumping station or the optional overboard macerator discharge system. The waste moves through a small opening in the toilet base. Incoming air mixes with and fragments the waste as it passes through the base opening. This process eliminates the need for a macerator or mechanical motors in the toilet base. When the tank is full, the indicators on the tank monitor (located in the port companionway lower electrical cabinet) will show full and the vacuum pump will not run.

The vacuum generator, located under the helm seat base, contains a stored vacuum and is connected to the holding tank. The system vacuum is monitored by a vacuum switch, which is located on the vacuum generator tank. When the switch senses a drop in vacuum pressure in the system, it automat-

ically signals the pump to energize and bring the vacuum back to operating level. This process is normally completed in less than a couple minutes.

It is normal for the stored vacuum to leak down slightly between flushes, causing the vacuum pump to run for a short period. After the last flush, the pump should not run more than once every three hours to recharge the system. Refer to the head owner's manual for more information on the operation of the system.

Holding Tank

Monitor the holding tank level using the holding tank monitor (located in the port companionway lower electrical cabinet), and have the tank pumped out before it is completely full.



Holding tank monitor

Lights on the monitor will indicate the fill levels of the waste tank and freshwater tank. The graphic guide on the left of the panel indicates if the waste tank is full or empty. If the tank is allowed to overflow, the waste will overflow out the tank vent and overboard.

To empty the waste tank:

1. At a marine facility pump-out station, remove the cap from the WASTE deck plate, located on the starboard gunwale, with the spanner wrench provided. Turn counterclockwise until the cap is loose; remove the cap and set it in a safe place.
2. Insert the pump-out station hose into the

WASTE deck plate opening.

3. Turn the pump-out station pump equipment on. Remove all waste from the holding tank (check the tank monitor for progress).
4. Insert the pump-out station's water hose into the WASTE deck plate opening. Fill the tank with clean water and repeat steps 2 and 3.
5. Replace the deck plate cap and tighten with the spanner wrench.



NOTICE

It is illegal to discharge raw sewage from a vessel within a three mile limit of the territorial waters of the United States of America. It is illegal to discharge raw sewage from a vessel within the navigable waters and rivers of the United States including the Great Lakes. When in international waters it is the responsibility of the vessel owner/operator to follow all local laws and restrictions.



NOTICE

Some local regulations require overboard discharge systems to be physically secured in a closed position during use of the boat in waters designated as “no discharge” areas. Check with local boating regulations. Refer to the system owner’s manual for additional information.

To pump waste overboard (if your boat is equipped with the optional overboard discharge seacock):

1. Ensure your vessel is in a legal raw sewage discharge area.
2. Locate the overboard waste discharge seacock in the mechanical space, aft of the water heater (if installed). Note: The

overboard discharge seacock is wired to the closed position at the factory.

3. Remove the cable tie securing the overboard discharge seacock.
4. Open the discharge seacock by pulling the handle to the vertical position.
5. Switch ON the WASTE PUMPOUT breaker on the DC distribution panel (located in the port companionway upper electrical cabinet). Allow the discharge pump to run until the waste tank is empty. The sound of the pump's motor load and speed will change when the tank becomes empty. **Note:** Should the pump not activate, check to see that the seacock is in the OPEN position and that the WASTE deck plate cover is tightened securely. If not, the discharge system will not operate properly.

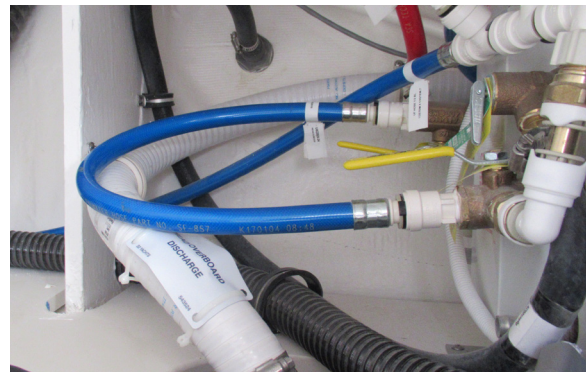

If installed, the optional waste discharge seacock is located aft of the water heater

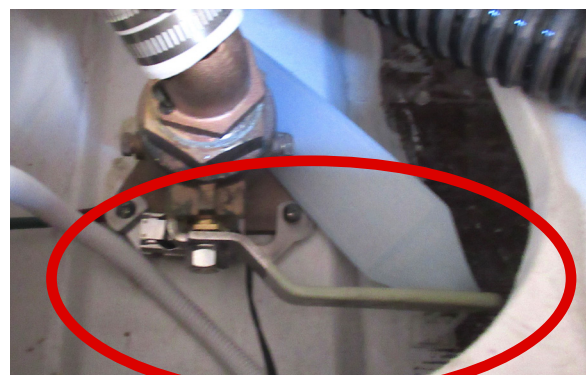

Waste discharge seacock

6. When the tank is empty, switch OFF the WASTE PUMPOUT breaker.

- Close the overboard discharge seacock by pushing the handle to the horizontal position, and secure it. The overboard discharge seacock **MUST** be closed to prevent water from being forced back into the system.

NOTICE

DO NOT operate the macerator dry; damage to the pump can occur. In some waters it is illegal to discharge waste overboard. Remove the seacock handle or use another method to prevent accidental discharge.

Holding Tank Maintenance

The tank vent air filter is located behind the starboard access panel in the helm seat base. Replace the holding tank vent air filter annually for the most effective odor control.



Tank vent filter, in the mechanical space near the holding tank

NOTICE

The head and macerator systems must be winterized before winter lay-up; refer to section 12, Seasonal Maintenance.

Clean and inspect the head for leaks regularly. Periodically add chemicals to the head to help control odor and to chemically break down the waste. Refer to the head owner's manual for additional operating and maintenance information.

5.4 Washdowns (optional)

If installed, the fresh water washdown uses water from the freshwater tank. The optional raw water washdown system pump is supplied by hoses connected to a ball valve and a thru-hull fitting located in the aft bilge on the port side of the mechanical space. The raw water washdown draws sea water from a thru-hull installed in the hull bottom.

Raw Water Washdown Operation

To use the optional raw water washdown, if installed, connect a hose to the labeled connection located outboard of the starboard cockpit gangway. Make sure the ball valve is open before attempting to operate the raw water washdown system. Activate the pump by turning **ON** the WASHDOWN switch on the DC distribution panel (installed in the port companionway upper electrical cabinet). As pressure builds in the washdown hose, the pump will shut off.



Optional fresh and raw washdown inlets

CAUTION

DO NOT operate the high-pressure pump when dry, or damage to the pump will result. Turn the raw water pump switch **OFF** when leaving the boat unattended.

When the washdown hose is in use and the pressure drops, the pump will turn on. Turn the WASHDOWN breaker off when the washdown is not in use. The raw water washdown system is equipped with a sea strainer on

the intake side of the pump, located in the mechanical space; check it frequently and clean as necessary.



Typical raw water strainer (left) and pump

Priming the System

Open the ball valve and switch ON the WASHDOWN PUMP switch on the DC distribution panel (installed in the port companionway upper electrical cabinet). Run the pump until all air is purged from the system. Close the thru-hull ball valve before the boat is hauled from the water to eliminate any air lock in the system. It may be necessary to re-prime the raw water system if the system is not used for an extended period.

5.5 Drainage

Some of the drain thru-hull fittings are equipped with ball valves that are always open under normal operating conditions. Check and operate the drain valves at least once a month to make sure they are in good condition and operating properly. Also, check the drain system to ensure it is free flowing and that the hoses on the thru-hull fittings are secure and not leaking.

Review and become familiar with the location of your boat's thru-hull drain valves.

In the event of an emergency, close the valves to prevent sea water from entering the boat through the drainage system. **NOTE:** Having one or more drain valves closed can be dangerous to the boat and all onboard. If this occurs, distribute PFDs and take all necessary safety precautions, including notifying the Coast Guard or local agency, until the problem is determined and corrected.

Bilge Drainage

The forward bilge pump is located under the cabin sole; the mid bilge pump is located in the forward mechanical space; and the aft bilge pump is located in the aft mechanical space.

All bilge pumps pump water out of thru-hulls located above the waterline in the hull. A high water bilge alarm monitors excessive bilge water levels and signals a high water condition through a visual and audible alarm. Under this condition, the bilge pumps will be automatically activated and the boat horn will sound until the bilge water falls to a safe level. The high water alarm is installed in the port companionway lower electrical cabinet. See section 4, Electrical Systems, for additional information on bilge pump and high water bilge alarm operations.

Excess water in the bilge area will adversely affect the handling and maneuverability of the boat and can cause personal injury. Use the BILGE buttons at the helm to manually activate the bilge pumps briefly each time the boat is used to ensure pumps are operating properly. There is a delay built into the bilge pump's float switch before the pump will activate. Refer to the bilge pump and float switch owner's manuals for details.

Power is supplied to the automatic float switches on each bilge pump whenever the batteries are connected. Debris can prevent the pumps from operating or make it operate continuously. Make sure no debris is blocking the bilge pump float switches.

Inspect the bilge areas frequently for evidence of excessive water. Continuous operation of a bilge pump can indicate that there is excess water in the bilge or a leak, or that a drain plug is installed incorrectly. Test the bilge pumps at regular intervals. Bilge pumps and bilge pumping systems are not designed for damage control.



Typical bilge pump and float switch (right)

DO NOT allow the bilge pump to operate after all the water has been cleared from the bilge area, or damage to the pump will occur. When water has been cleared, turn OFF the BILGE buttons at the forward helm.

When the boat is out of the water, the bilge can be drained by unplugging the thru-hull drain located in the hull bottom near the transom. It is important to check the drain plug regularly to make sure it is tight. A loose drain plug will allow sea water to enter the bilge and cause the boat to sink. Check the drain plug frequently to make sure it is secure.

Any oil spilled in the bilge must be thoroughly removed and properly disposed of before operating the bilge pump. The discharge of oil from the bilge is illegal and subject to fine.



NOTICE

The US Federal Water Pollution Control Act prohibits the discharge of oil or oily waste into or upon the navigable waters of the United States or the waters of the contiguous zone if such discharge causes a film or sheen upon, or a discoloration of the surface of the water, or causes a sludge or emulsion beneath the surface of the water. Violators are subject to a penalty of \$10,000.

Exterior Drains

The cockpit sink drains by gravity to overboard thru-hulls.

The anchor locker drains overboard through a drain fitting located in the hull side at the bottom of the anchor locker. It is important to inspect the drain frequently to remove any accumulated debris.

5.6 Plumbing System Maintenance

Refer to your water system components owner's manuals for additional operation and maintenance information.

Freshwater System

Perform these routine maintenance procedures to maintain your freshwater system:

- Remove filter screens from faucet spouts and eliminate any accumulated debris. A debris build-up can cause the water pump to cycle excessively.
- Check and clean the freshwater system strainer (located on the intake line near the pump) at least annually.
- Test each bilge pump's float switch by holding two fingers over the raised circular areas of the switch for approximately 10 seconds to activate the pump.
- Remove the lid on the shower sump

assembly, located under the cabin sole floor hatch, periodically. Clean debris from the sump and flush with clean water. Activate the float switch to test the pump. Spray the pumps and metal components with a metal protector periodically.

- Add a commercially available potable water conditioner to the water tank(s) to keep it fresh.
- Make sure the FRESH WATER PUMP breaker on the DC distribution panel is switched OFF when leaving the boat unattended or when not in use.
- Change the freshwater filter annually.



CAUTION

Turn the DC distribution panel FRESH WATER PUMP breaker(s) OFF when leaving the boat unattended or when the fresh water system is not in use.

The water system must be winterized before storage. Refer to section 12, Seasonal Maintenance.

Raw Water System

Perform these routine maintenance procedures to maintain your raw water system:

- Check all hoses, and especially the sea water hoses, for signs of deterioration.
- Remove and clean the air conditioner and washdown pump sea water strainers, as needed. Spray the pumps and thru-hull valves with a metal protector periodically.
- Operate all thru-hull valves at least once a month to keep them operating properly.

If a hose ruptures or leaks, turn off the washdown pump, using the WASHDOWN PUMP breaker on the DC distribution panel, immediately. Keep the thru-hull valve closed when performing service on a sea water system.



CAUTION

Maintain a proper charge on the batteries; operating the pressure pump from a battery with a low charge could lead to pump failure.



CAUTION

If a hose ruptures, turn the WASH-DOWN breaker on the DC distribution panel OFF. Close the thru-hull valve before performing maintenance on the sea water pump. Operating any pump from a low-charged battery can lead to a pump failure. Keep the batteries properly charged. The raw water system must be properly winterized prior to winter lay-up. Refer to section 12, Seasonal Maintenance.

Raw Water Intake Strainers

The air conditioning raw water intake, generator raw water intake, and raw water washdown pump intake (if installed) are equipped with strainers. Check the strainers each time you use the boat to ensure that no debris has accumulated that may block the flow of water.

To clean clogged strainers:

1. Turn OFF the related engine or pump.
2. Close the raw water seacock, in the hull bottom, to stop the flow of water to the strainer.
3. Remove the filter basket cap by unscrewing it counterclockwise. A spanner wrench has been provided for this purpose.
4. Lift the filter basket out by the top handle.
5. Remove any debris from the filter basket and rinse with clean water.
6. Use only mild soapy water to clean the sight glass.
7. Check to be sure that the o-ring under

the cap is intact and replace if necessary.

8. Apply a waterproof grease that is silicon- or Teflon-based (do not use petroleum-based grease) to the cap threads and o-ring seasonally, to assure easy cap loosening for inspections and cleaning.



Water strainer (typical)

9. Install the filter basket.
10. Install the cap, and tighten by hand.
11. Snug the cap with the spanner wrench.
12. Open the seacock.
13. Start the related engine or pump, and check the system for leaks.
14. If the strainer is leaking, immediately close the related seacock and verify the filter cap is installed correctly with a good o-ring.

The raw water system must be winterized before storage. For more information, refer to section 12, Seasonal Maintenance.

Drainage Systems

Perform these routine maintenance procedures to maintain your drainage system:

- Clean the cockpit drain rails with a hose and water to remove all debris.
- Clean the hardtop leg drain holes, especially before winter storage.
- Clean the bilge pump of any debris.
- Check the bilge for debris that can block the function of the automatic switch.
- Test each automatic bilge pump float

switch each time the boat is used, for proper operation. Hold two fingers over the raised circular areas of the switch for approximately 10 seconds to activate the pump. Alternatively, add water to the bilge until the water level is high enough to activate the pump.

- Test the high water alarm each time the boat is used. Press the TEST button on the alarm panel, located in the port companionway lower electrical cabinet.
- Flush all gravity drains with fresh water periodically, to keep them clean and free-flowing.
- Clean and inspect the shower and sink drain sump system periodically; the sump may be accessed by lifting the cabin floor hatch. Remove accumulated debris and flush with fresh water.



CAUTION

DO NOT use harsh chemical drain cleaners in drain systems; permanent damage to the hoses, fittings, and system can result. Drains and pumps must be properly winterized before winter lay-up.

- Operate the thru-hull valves once a month and service as required.
- Check the drain system regularly to ensure it is free-flowing and that the hoses on the thru-hull fittings are secure and not leaking.
- Keep the o-ring on the insert end of the washdown hoses lubricated. Apply a mild liquid soap such as a liquid dish soap or boat wash to the insert on the hose end. For a long-term lubrication solution, apply petroleum jelly such as Vaseline. Apply a light coat to the hose connection and insert it into the washdown port. Depending on your location and usage, a monthly application may be necessary.

Ventilation Systems

Ventilation is supplied by opening portlights or using the air conditioning system.

6.1 Air Conditioning System

The air conditioning system can be operated to cool or heat. The mid-cockpit air conditioning unit is located behind a removable panel under the helm seat base. If installed, the optional cabin and head air conditioner is located behind the head toilet. Do not store items in these compartments. Items stored on or immediately next to an air conditioning unit could cause damage to the air conditioner or be damaged by heat or condensation.

To operate the unit(s), first turn ON the AIR COND and AIR COND PUMP breakers on the AC distribution panel (installed in the port companionway upper electrical cabinet). The temperature is controlled using the climate control panels in the port companionway upper electrical cabinet.

The cold air return is under the companionway steps. To obtain maximum efficiency from the air conditioner, do not obstruct the air return.

The air conditioner is self-contained and sea water cooled. The cooling pump supplies sea water to the unit, which cools the condensing unit and is discharged overboard. The pump is located in the port mechanical space.



Air conditioning valve, strainer, and pump

Sea water is supplied to the pump from a thru-hull fitting located in the hull near the pump. A sea strainer between the pump and thru-hull fitting protects the system from contaminants that can damage the pump or the air conditioning system. Periodically clean the sea strainer basket to make sure the sea water pump receives adequate water.

Air locks can occur in the cooling pump water supply at the time of launching. If your boat has been recently launched and water is not flowing from the overboard thru-hull when the AIR COND PUMP breaker on the AC distribution panel is ON, air may need to be purged from the system. This can be achieved by making sure the valve at the cooling pump intake thru-hull is open. Then run the boat at cruise speed for several minutes. A scoop attached to the intake thru-hull will pressurize the system and force the air through the pump. Refer to the air conditioner owner's manual for additional operating and maintenance information.

!

NOTICE

Air conditioners use surface water to cool. DO NOT operate the air conditioner out of the water or without the raw water supply, or else damage to the system will occur. Confirm a water supply before operating the air conditioning. The lack of a water supply can also trip the circuit breaker.

6.2 Portlights

Portlights are secured by adjustable dogs. The dogs should be adjusted so they are tight enough to seal the window in the closed position, but not so tight that they are difficult to latch. The dogs are adjusted by turning a screw. The screw increases or decreases the pressure on each dog.

6.3 Carbon Monoxide

Read about carbon monoxide, its hazards, and the carbon monoxide detector in section 9, Safety Information.

6.4 Bilge Ventilation

Air flow into the bilge is supplied by a vent on the transom and through use of the mechanical space blower. To activate, use the BLOWER button on the helm.

6.5 Maintenance

- Periodically lubricate all hinges and latch assemblies with a light oil. Clean and coat gasket materials with silicone to help keep them pliable.
- The opening portlights are made of acrylic plastic. Acrylic can scratch easily. DO NOT use a dry cloth or glass cleaning solutions; use a soft cloth, mild soap, and water for routine cleaning. Solvents and products containing ammonia can permanently damage acrylic. Refer to the acrylic plastic information in section 11, Routine Maintenance, for directions for properly maintaining acrylic.
- Carbon monoxide detectors have a limited life span. The End of Life (EOL) date, five (5) years after the manufactured date, can be found on a sticker adhered to the body of the unit. Plan on replacing this unit prior to the EOL date. See the carbon monoxide detector owner's manual for more information.

Exterior Equipment

7.1 Forward Deck

 **CAUTION**

Unsecured open doors and/or hatches can slam closed and cause injury or damage the boat. Most doors and hatches are equipped with fasteners, hatch lifters, snaps, and/or straps to secure them open; make sure they are properly secured while they are open.

Rails and Deck Hardware

Rails and deck hardware perform specific functions. Do not use for securing fenders or mooring lines, which must be secured to the cleats. Make sure mooring lines are clear of rails or stanchions, or damage can result.

Cleats are flush-mounted and must be raised prior to use.

DO NOT use cleats or any other hardware for the purpose of towing or being towed. Inspect all hardware periodically for loosening, wear, or damage. Repair or replace immediately.

 **WARNING**

The cleats on your boat have not been designed for, and are not intended to be used for, towing. Using them for this purpose could result in personal injury or damage to your boat. Refer to *Chapman Piloting & Seamanship* for proper towing procedures.

Anchor/Rope Locker

The anchor locker at the bow of the boat can be accessed through the forward deck hatch. An anchor chute and roller assembly is integrated into the bow stem. The chute and roller assembly is designed for a Delta plow type anchor. A chain snubber is provided to secure the anchor during storage. Use the

snubber to ensure the anchor chain is secure before getting underway. The anchor locker is drained by a thru-hull fitting in the hull side near the bottom of the locker. Check it frequently and keep it clean and free flowing.

The anchor must be securely stowed when not in use.

 **CAUTION**

Secure the anchor when it is stored in its locker and make sure it does not rest against the hull sides. If the anchor is loose, it will bounce and damage the boat. Damage from the anchor bouncing in the locker is not covered by the Tiara Yachts warranty.

Windlass

The windlass is located under the forward deck hatch in the anchor locker. The anchor is stored in the bow anchor chute and is raised and lowered by the windlass. The anchor line is stored below the windlass and routed out through the windlass to the chain and anchor. The anchor locker is equipped with a receptacle for the windlass remote control.

 **WARNING**

MOVING PARTS OR ENTANGLEMENT HAZARD
Contact with moving parts can entangle and cut, resulting in loss of body parts, strangulation, and/or severe loss of blood, causing serious injury or death. Stay clear of moving parts.

Become familiar with the safe operation of the windlass before using it. Refer to the windlass owner’s user manual for operating instructions. Specifics regarding the proper techniques, equipment, and conditions for safe anchoring can be found in *Chapman Piloting & Seamanship*, or through a boating safety course.

To operate the windlass, the WINDLASS breaker on the Master DC Panel in the mechanical space must be switched ON.

The anchor is lowered by releasing the anchor from the cleat or chain snubber in the locker and activating the windlass using the remote switch in the anchor locker or the WINDLASS DEPLOY switch at the helm. After the anchor is set, do not allow the windlass to take the force from the anchor line; secure the rode to the cleat in the anchor locker.

⚠ CAUTION

DO NOT use the windlass as the only method of securing the anchor in the bow pulpit. Secure the anchor line to a cleat or chain snubber before operating your boat.



Windlass and anchor rode cleat (typical)

Boats at anchor in high swell conditions will snub on the anchor line. This can cause slippage or apply excessive loads to the windlass.

Windlasses are not designed to hold high loads while a boat is at anchor. When the windlass is not in use and the boat is at anchor, the rope rode must be properly tied off to the cleat inside the anchor locker. If your boat is equipped with an all-chain rode, the rode must be secured using the chain stopper that is mounted forward of the windlass.

The anchor is retrieved by releasing the line from the bow cleat and activating the windlass using the remote switch in the anchor locker or the WINDLASS RETRIEVE switch at the helm. Once the anchor is retrieved, secure the anchor to the chain snubber or bow cleat to prevent it from being released while underway.

DO NOT use the windlass as a winch to move the boat over the anchor. Move the boat under its own power to the anchor and to break the anchor loose.

Foredeck Lounge

The foredeck lounge features movable armrests, removable table, drink holders, an optional stereo remote control panel (if equipped), speakers, and optional forward sun shade poles and canvas, if equipped.

Weather covers are provided to protect the lounge and electronics when the boat is not in use. Snap the covers into place before leaving the boat. Remove and securely stow the covers before operating the boat.

Forward Mediterranean-style Sunshade (optional)

An optional forward Mediterranean-style sunshade provides shade over the forward lounge. See the sunshade owner's manual for additional information.

To set up the sunshade:

- Locate the canvas shade and the sunshade poles, stored under the forward lounge port seat cushion.
- Locate the shade pole receptacles on the forward gunwales and at the bow.
- Press the release button to slide the cover plates out of the receptacles, and store them.
- Slide each pole base into its receptacle until it is latched in place.
- Attach the sunshade canvas to the underside of the forward hardtop overhang.
- Attach the sunshade canvas to the cords

- attached to the shade poles.
- Cinch the cords to tighten the sunshade.

Stow the sunshade and poles during high winds or inclement weather; when underway above idle speeds; before transporting the boat overland; and before storing the boat.

Windshield

Your boat is equipped with a custom integrated fiberglass-framed windshield with tempered glass.

CAUTION

When routing electric cables and dockside water hoses from the boat to the dock, be sure to allow sufficient slack so cables and hoses will not be strained in any way as the boat moves within its slip. Do not allow cables or hoses to dangle into the water.

7.2 Hardtop

Hardtop

The hardtop is designed to accommodate radio antennas, radar antennas, navigation lights and the horn. The hardtop is not designed to support the additional weight of items like an instrument locker or a life raft. Radar and electronics antennas must be mounted to the top between the windshield and rear legs. Do not mount any antennas or equipment to the brow area. The hardtop frame is not designed to support the weight of accessories in this area and can be damaged.

The hardtop warranty will be voided if the top is modified in any way or heavy accessories are mounted to the top. Also, if items like radar antennas, spotlights, and other accessories are mounted in the wrong location, the warranty can be voided. If you intend to add equipment or make modifications to the hardtop, contact Tiara Yachts Customer Relations to make sure the equipment you would like to

add or the intended modification will not void the hardtop warranty.

CAUTION

Care should be exercised to prevent damage to powder coated surfaces. If the surface is scratched, chipped, or worn, exposing the aluminum, it should be resealed to prevent corrosion from forming. If corrosion is allowed to form, it could cause the powder coating to bubble and lift away. Contact your dealer for repair service.

Sunroof Hatch

The hardtop features an opening hatch above the helm. Manually retractable blinds provide shade.

Hardtop Lighting

The hardtop is equipped with overhead white and red LED lights. Use the overhead red lights when navigating at night. Operate the overhead lights using the HARDTOP WHT LTS and HARDTOP RED LTS buttons on the helm.

Makefast Sun Shade

The Makefast[®] sun shade is electrically powered and extends to shade the aft cockpit. Activate the sun shade using the SUNSHADE OPEN and CLOSE buttons on the helm. The SUNSHADE breaker on the DC distribution panel (installed in the port companionway upper electrical cabinet) must be switched ON.

CAUTION

The sun shade must be retracted during severe wind conditions, or when boat speeds exceed 5 mph.

7.3 Mid Cockpit

Helm Console

The helm console is the main operating position on your boat. See section 2, Helm Systems, for more information.

Helm and Companion Seats

The helm and companion seats feature flip-up bolsters. The helm seat can be adjusted fore and aft using the SEAT FWD/AFT switch located on the helm. The port seat features a fold-down footrest on the forward seat base.

Weather covers are provided to protect the helm console and electronics when the boat is not in use. Snap the covers into place before leaving the boat. Remove and securely stow the covers before operating the boat.

Stereo and VHF Radio

Operate the stereo using the stereo head unit at the helm or, if installed, the optional remote control panels in the foredeck lounge and the aft cockpit. Refer to the stereo owner's manuals for additional operating information.

The VHF radio is located on the port side of the helm console.

Air Conditioning

The mid cockpit air conditioning system is controlled using the control panel located in the port companionway upper electrical cabinet. Refer to the climate control information in section 6, Ventilation Systems.

The cold air return is located under the companionway steps. In order to obtain maximum efficiency for the air conditioning unit, do not obstruct this area.

Shore Power Connection

The shore power inlet is located on the aft face of the port side boarding steps. See section 4, Electrical Systems, for information about connecting to shore power.



Shore power inlet

Water Washdowns (optional)

If equipped, the fresh and raw water washdown connections are located outboard of the starboard cockpit. To use a washdown connection, the WASHDOWN PUMP on the DC distribution panel must be ON. See section 5, Plumbing Systems, for more information.

Cockpit Accent Lighting (optional)

If installed, multi-color, recessed accent rope lighting is integrated throughout the hardtop and cockpit. Control the lights using the black knob on the port side of the helm console:

- To turn the accent lights on, push and hold the knob for one second.
- To select the color, push the knob once and turn right or left.
- To adjust the brightness, push the knob a second time and turn right to increase or left to decrease.
- To select the speed of the color fade, push the knob a third time. Turn right to speed up or left to slow down.
- To turn off, push and hold the knob for three seconds.

See the lighting system owner's manual for more information.

Refrigerator and Cooler Space

A refrigerator is installed underneath the port helm seat. To operate, switch ON the REFRIGERATOR breaker on the DC distribution panel, located in the port companionway

upper electrical cabinet. The temperature is controlled using the thermostat inside the unit. Refer to the refrigeration system owner's manual for more information.

Space is provided under the starboard helm seat for a 45-quart cooler.

7.4 Mid Cockpit Galley

The galley includes a sink, optional grill, 120V outlet, solid surface countertop, and waste-basket. A door on the outboard port galley console provides access to the waste basket and storage space for the sink cover.

Grill (optional)

If installed, the optional 120/230V electric grill is located in the cockpit galley. The grill cover opens and locks into place.

WARNING

Severe burns can occur from the improper use of this device. Do not leave the grill unattended when it is hot. Close supervision is required when the grill is being used or is hot. Do not use the grill while underway.

NOTICE

Do not set the grill lid over a warm grill. Allow the grill to cool completely before covering. Failure to do so could result in damage to the lid and grill.

NOTICE

After cooking, clean the grill surface. Allow the grill to cool. Lift the grill grate and carefully remove and empty the fully cooled drip pan. Close the lid only after the grill has cooled. Failure to do so could result in damage to the grill or grill area.

To use the grill, turn ON the DECK GRILL breaker on the AC distribution panel, installed in the port companionway upper electrical cabinet. Turn the breaker OFF whenever the grill is not being used. Closing the grill lid automatically turns the breaker OFF. Allow the grill to cool before closing the grill drawer, to avoid damage to the grill. Never clean the grill with any form of pressurized water or other types of cleaners. Use only a cloth and a stainless steel or glass surface cleaner. This grill, like all appliances, has the potential to create safety hazards through careless or improper use. Observe all of the safety precautions listed in the grill owner's manual.

Television (optional)

The optional flatscreen television may be mounted on the cockpit buffet, aft of the helm seat. Dedicated storage for the TV is located in the cabin hanging locker. Refer to the TV owner's manual for operating instructions. A television antenna is installed on the hardtop.

7.5 Aft Cockpit

Mechanical Space Access

The center floor hatch in the aft cockpit provides access to the mechanical space.

Table

The cockpit table base is stored under the aft lounge seat cushion. The table top is stored on the underside of the cockpit floor hatch. Secure the table leg into any of the table mounts (on the forward or aft side of the aft lounge base, or on the aft side of the forward lounge base). Remove the table from the aft lounge before sliding the aft lounge forward.

Aft-facing Seating

The aft-facing lounge seat features storage under the cushions. A fire extinguisher is stored under the port cushion.

Aft Lounge Seating/Sunpad

There are a number of ways you can configure the aft cockpit.



Aft cockpit table installed in the forward mount of the aft lounge seat

To move the aft lounge along the floor slides, locate the latch on the aft starboard side of the aft lounge seat base. Lift and hold the latch open and push the lounge forward. The lounge may be secured in multiple positions along the tracks. Once in the position you desire, be sure to move the lounge a bit forward and aft until it securely locks into place. Lower the latch.

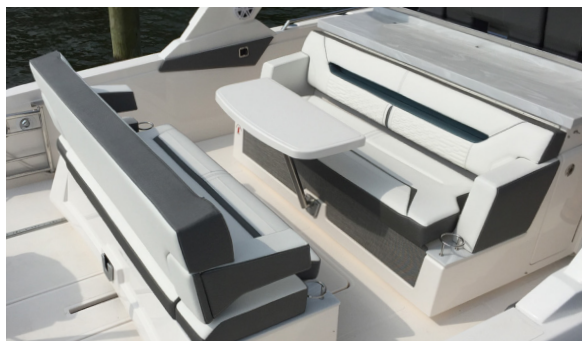

Aft lounge moved forward, with the table in the forward table mount, for group dining

To configure the aft lounge as a sunpad, locate the latch on the port forward side of the aft lounge seat base. Lift and hold the latch open while pushing the aft lounge seatback forward of the seat base, until it is resting flat. Lower the latch.



Aft lounge configured as a sunpad



Aft lounge moved forward, creating one larger sunpad

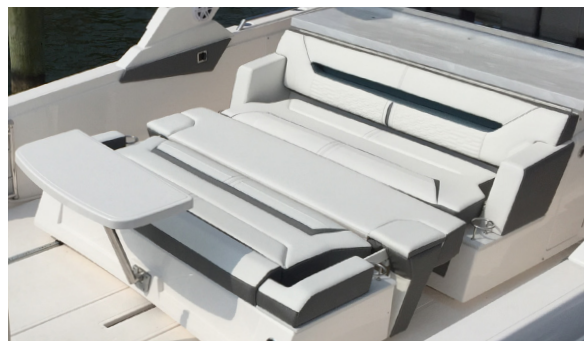

One large sunpad, with table installed in the aft lounge seat's aft table mount

NOTE: The aft lounge should be securely locked in the upright position anytime the boat is underway. Do not run the engines or operate the boat while the aft lounge is in the lowered sunpad position.

 **WARNING**

Do not run the engines or operate the boat while the aft lounge is in the lowered sunpad position.

Aft Cockpit Weather Covers

Weather covers are provided to protect the U-lounge and electronics when the boat is not in use. Snap the covers into place before leaving the boat. Remove and securely stow the covers before operating the boat.

7.6 Stern

Transom Doors

Do not use the transom doors when the boat is in motion. DO NOT leave the transom doors unlatched. Always latch the doors in the fully CLOSED position while the boat is underway. Latch them in the fully OPEN position or fully CLOSED position when the boat is not underway.

 **CAUTION**

Periodically inspect transom door fittings for wear, damage, or loose fit. Repair or replace before using your boat.

 **NOTICE**

Acrylic plastic scratches easily. Use a soft cloth and mild soap and water for routine cleaning. DO NOT use a dry cloth, abrasives, or glass cleaning solutions on acrylic. Solvents and products containing ammonia can permanently damage acrylic plastic.

The transom doors feature a clear acrylic panel. Use a soft cloth and mild soap and water for routine cleaning. **Do not use abrasive cleaners. Solvents and products con-**

taining ammonia, such as Windex®, can permanently damage acrylic plastic.

Transom Shower

A fresh water shower is located outboard of the port transom gangway. It is supplied cold water by the fresh water system (and hot water by the optional water heater, if installed).

To operate, switch ON the FRESH WATER PUMP breaker on the DC distribution panel and, if installed, the WATER HEATER breaker on the AC distribution panel. Distribution panels are installed in the port companionway upper electrical cabinet. Pull the shower wand out of the holder and twist to start the flow of water and adjust the temperature. Before placing the wand back in the holder, ensure the wand is shut OFF completely. Failure to do so will cause the fresh water pump to run and water to leak into the bilge.

Swim Platform and Boarding Ladder

A fold-out boarding ladder is installed under a hatch on the port side of the integrated swim platform. DO NOT use the swim platform or ladder(s) while an engine is running. All engines must be OFF when swimmers are in the water and before allowing anyone to enter or exit the boat. Stow the ladder before starting any engines.

 **DANGER**

CARBON MONOXIDE POISONING AND/OR ROTATING PARTS HAZARD
Poisonous CO gases are present at the rear of the boat when an engine is running. A rotating propeller can cut or entangle swimmers. Either of these hazards will cause death or serious injury. **DO NOT use the swim/boarding platform when the engine is running.**

Interior Equipment

8.1 Safety Equipment

Familiarize yourself with the safety equipment found in the cabin. A smoke detector and carbon monoxide alarm are located in the starboard forward-facing wall and headliner. The cabin fire extinguisher is stored in the port hanging locker. Read about carbon monoxide, its hazards, and the carbon monoxide detector in section 9, Safety Information.

 **WARNING**

The carbon monoxide (CO) monitoring system is only a supplemental safety aid. Follow all safety procedures found in this manual. Carbon monoxide is a lethal, toxic gas that will cause death at certain levels.

8.2 Companionway

The cabin is accessed through a sliding door. Behind the companionway door is a screen door. Lockable latches secure the doors in the closed position, and vinyl-covered latches secure the doors in the open position. DO NOT leave either door unlatched. Latch the doors in the full OPEN or full CLOSED position.

 **CAUTION**

Keep the cabin door latched in the open or closed position. If the door is unlatched, it will move as the boat rocks, causing injury or damage.

The doors are made of acrylic plastic. Acrylic plastic scratches easily and can chip. Refer to section 11, Routine Maintenance, for proper care of acrylic plastic.

 **NOTICE**

Acrylic plastic scratches easily. Use a soft cloth and mild soap and water for routine cleaning. DO NOT use a dry cloth, abrasives, or glass cleaning solutions on acrylic. Solvents and products containing ammonia can permanently damage acrylic plastic.

Electrical Cabinets

The AC and DC distribution panels, waste and water tanks monitor, and climate control panel(s) are housed in the port companionway upper electrical cabinet.

The generator control panel, high water alarm, outlets, and a stereo auxiliary input jack are housed in the port companionway lower electrical cabinet. See section 4, Electrical Systems, for more information.

8.3 Main Cabin

The main cabin features a full berth, head compartment with shower, and hanging locker. A fire extinguisher, and the optional cockpit television, are stored in the hanging locker.

Air Conditioning (optional)

If equipped, the cabin air conditioning control panel is located in the port companionway upper electrical cabinet. The air conditioning unit is located behind a panel aft of the toilet. The. Refer to section 6, Ventilation Systems, for more information.

Switch Panels, Outlets, and USB Ports

Operate the cabin lighting using the switch panels located on the port companionway wall and the port, forward-facing wall aft of the berth.

Outlets and a USB charging port are located on the port forward-facing wall aft of the berth. Additional outlets are located in the head.

Access to Components

The cabin sole floor hatch provides access to the shower sump box and forward bilge pump.



Shower sump box (left) and bilge pump

To access the bow thruster, remove the access panel under the berth mattress.

Television storage (optional)

Dedicated storage for the optional cockpit flatscreen television, if equipped, is provided in the cabin hanging locker.

8.4 Head Compartment

The head compartment is equipped with a toilet, fresh water sink with pullout faucet/shower head, integrated shower curtain, storage, and waste basket (under the countertop aft of the sink). Pull the curtain closed along the tracks when showering in order to protect the wood countertop from water. Secure the head compartment door in the closed position whenever the boat is underway to prevent damage to the door.

An opening portlight provides daylight and ventilation.

The countertop may be made of Corian®. Refer to section 11, Routine Maintenance, for Corian care information.

When the FRESH WATER PUMP and SHOWER SUMP breakers on the DC distribution panel are on, the water system will operate much like a home water system. Refer to section 5, Plumbing Systems, for more information on operating the system. For care and cleaning information, refer to section 11, Routine Maintenance.

Head Switch Panels

Switches that operate the overhead lighting for the head compartment are located on the forward aft-facing bulkhead. An AC GFI duplex outlet is installed below the light switches.

The fresh water and holding tank monitor panel, located in the port companionway lower electrical cabinet, displays the fresh water tank and waste holding tank levels.

8.5 Marine Head System

Your boat is equipped with a VacuFlush® marine head system. Before using the toilet, ensure the VACUUM PUMP breaker on the DC distribution panel is ON. For information about the marine head system, see section 5, Plumbing Systems.

Safety Information

9.1 General

Your boat and outboard engines have been equipped with safety equipment designed to enhance the safe operation of the boat and to meet U.S. Coast Guard safety standards. The Coast Guard and state, county, and municipal law enforcement agencies require certain additional accessory safety equipment on each boat. This equipment varies according to length and type of boat and type of propulsion. Most of the accessory equipment required by the Coast Guard is described in this section. Some local laws require additional equipment. Read *A Boat-er's Guide to the Federal Requirements for Recreational Boats*, published by the US Coast Guard and included with this manual, and obtain copies of state and local laws, to make sure you have the required equipment for your boating area. Visit www.uscgboating.org for more information. We also strongly recommend reading the latest edition of the book *Chapman Piloting & Seamanship*.

Your boat may be equipped with engine alarms and cabin monitoring equipment. These systems are designed to increase your boating safety by alerting you to potentially serious problems in the primary power systems, the mechanical space and the cabin. Alarm systems are not intended to lessen or replace good maintenance and a pre-cruise system check. Refer to the *Pre-Cruise Checklist* at the start of this manual, and sections 11 and 12 for maintenance information.

This section describes safety-related equipment that could be installed on your boat, depending on the type of engines and other options installed by you or your dealer.

9.2 Engine Alarms

Most outboards are equipped with an audible alarm system mounted in the helm area that monitors selected critical engine systems. The alarm will sound if one of these systems

begins to fail. Refer to the engine owner's manual for information on the alarms installed with your engines, as well as additional operating and maintenance information.

If the alarm sounds:

- Throttle the engines back to idle immediately.
- Shift to neutral.
- Monitor the engine gauges to determine the cause of the problem.
- If necessary, shut off the engines and investigate until the cause of the problem is found.
- If the boat is equipped with water sensors in the fuel filters, make sure to check them for excessive water.

9.3 Neutral Safety Switch

Every throttle/shift control system has a neutral safety switch. The switch allows the engines to be started in NEUTRAL only. If engines will not start, make sure controls are in NEUTRAL. Refer to section 2 for neutral safety switch information.

9.4 Engine Stop Switch

Your Tiara Yacht is equipped with an engine stop switch, clip and lanyard. When the lanyard is pulled, it will shut off the engines.

The stop switch will stop an engine whenever the lanyard is pulled far enough to disconnect the clip from the switch. Attach the lanyard to the boat operator whenever an engine is running, but be aware of loss of engine power if the switch is activated.

If the operator is thrown from the seat, or moves too far from the helm, the lanyard will disconnect the clip from the switch, shutting off the engine.

To attach a lanyard, connect the clip to the emergency stop switch and the hook to a strong piece of clothing on the operator, such as a belt loop.

**WARNING****LOSS OF CONTROL AND UNSAFE BOAT HAZARD**

An engine stop switch system that is not used or does not function correctly can cause death or serious injury. DO NOT operate the boat if the stop switch system does not function properly.

If the engines will not start, check to see if the clip isn't inserted into the engine stop switch properly or the control is not in neutral. Make sure the clip is properly attached to the engine stop switch before attempting to start the engine.

Always carry a spare stop switch clip and lanyard and instruct at least one other person onboard regarding the operation of the stop switch and location of the spare.

9.5 Fire Safety**Fire Extinguishers**

Coast Guard-approved fire extinguishers are hand-portable, either B-I or B-II classification, and have a specific marine-type mounting bracket. It is recommended the extinguishers be mounted in a readily accessible position. Your Tiara Yacht comes equipped with the fire extinguishers in these locations:

- inside the cockpit aft-facing seat base
- in the port cabin hanging locker

Check fire extinguishers at the start of each season and have them charged or replaced as necessary.

Fire extinguishers require regular inspections to ensure:

- Seals and tamper indicators are not broken or missing.
- Pressure gauges or indicators read in

the operable range.

- There is no obvious physical damage, corrosion, leakage or clogged nozzles.

For information on the type and size fire extinguisher required for your boat, visit uscgboating.org or refer to *A Boater's Guide to Federal Requirements for Recreational Boats*, provided with this manual.

Information about halon or agent FE-241 extinguishers is provided by the manufacturer. It is extremely important that you learn about and understand and know how this system works; refer to the manufacturer's literature.

Automatic Generator Fire Extinguishing System

If your boat is equipped with a generator, an automatic fire extinguishing system is installed. It is extremely important that you learn about and understand how this system works; refer to the manufacturer's owner's manual for additional information.

**WARNING**

If a mechanical space fire should occur, turn off all main electrical switches and shut down the generator. Do not open the mechanical space hatch. Allow the fire extinguisher chemical to soak the mechanical space for at least fifteen (15) minutes.

The generator fire suppression system is located overhead in the mechanical space, just aft of the generator, and operates automatically. The extinguisher has been chosen and located to provide sufficient coverage of the generator compartment. While the system helps ensure bilge fire protection, it does not eliminate the U.S. Coast Guard requirement for hand held fire extinguishers.

! WARNING

FIRE/EXPLOSION HAZARD
The gas of the fire extinguisher system displaces oxygen to “smother” the fire. DO NOT open the hatch. Oxygen can feed a fire and flashback can occur, which can cause death or serious injury. If the onboard fire system discharges, wait at least 15 minutes before opening engine hatch.

The manual discharge pin is located below the center helm seat, on the forward face of the seat box. To manually discharge the fire suppression system, remove the pin and pull the red handle.



Fire system manual discharge pull

The system is equipped with an engine shutdown circuit to automatically shut down the generator. The red light on the Fireboy status indicator (on the helm) will light and an alarm will sound if this should occur. Shut down all engines immediately. Turn off all electrical systems and powered ventilation, and extinguish all smoking materials. DO NOT open the mechanical space hatch, because this will feed oxygen to the fire and allow a flashback to occur. Allow the extinguishing agent to soak the generator compartment for at least 15 minutes and wait for hot metals or fuels to cool before inspecting for cause or damage. Have an approved portable fire extinguisher at hand and ready for use and DO NOT breathe fumes or vapors caused by the fire.

After the fire suppression system discharges, turn on the BLOWER switch at the helm and operate the generator blower for five minutes. Open the mechanical space to evacuate the fire suppression agent and find and fix the problem.

To restart the engines, press the override button on the helm-mounted Fireboy system status indicator. Refer to the system owners manual for more information.



Fire system status indicator and override button

Bilge And Fuel Fires

Fuel compartment and bilge fires or explosions are dangerous because of the presence of fuel. You must make the decision to fight the fire or abandon the boat. If the fire cannot be extinguished quickly or it is too intense to fight, abandoning the boat may be your only option. You must consider your safety, the safety of your passengers, the intensity of the fire, and the possibility of an explosion in your decision.

If you find yourself in this situation, make sure all passengers have a life preserver, go over the side, and swim well upwind of the boat, to keep clear of any burning fuel that could be released and spread on the water as the boat burns or in the event of an explosion. When clear of the danger, check and account for all passengers who were onboard. Give whatever assistance you can to anyone in need or in the water without a buoyant device. Keep everyone together for morale and to aid rescue operations.

9.6 Carbon Monoxide Safety

Carbon Monoxide Detector

A carbon monoxide detector is installed in the starboard cabin headliner of each berth. CO detectors warn occupants of dangerous accumulation of CO gas. If a carbon monoxide detector is activated, this indicates the presence of CO, which can be fatal. Evacuate the cabin immediately. Make sure all passengers are accounted for. DO NOT enter the cabin until you know it is safe to do so and the problem found and corrected.

The CO detector is powered by a 9v battery. A power light indicates that the detector is powered and working. Test the detector and replace the battery on a regular basis. Make sure the indicator light is on whenever the cabin is occupied.

This device uses a micro controller to continuously measure and accumulate CO levels. Should a very high level of CO exist, the alarm will sound within a few minutes. If small quantities are present or high levels are short-lived, the detector will accumulate the information and determine when an alarm level has been reached.

While a CO detector enhances your protection from CO poisoning, it does not guarantee it will not occur. Do not use CO detectors as a replacement for ordinary precautions or periodic inspections of equipment. Never rely on alarm systems to save lives; common sense is still the best form of protection. Remember, the boat operator carries the ultimate responsibility to make sure the boat is properly ventilated and passengers are not exposed to dangerous levels of CO. Be alert to the symptoms and early warning signs of carbon monoxide.

CO detectors are very reliable and rarely sound false alarms. If the alarm sounds, DO NOT think it is false. If anyone has been exposed to CO, move them into fresh air immediately.

Contact the detector manufacturer, Tiara Yachts Customer Relations, or your local fire department for assistance in finding and correcting the situation. Never disable the CO detector because you think the alarm may be false.

Carbon Monoxide Hazards

Carbon monoxide (CO) is a by-product of combustion, is invisible, tasteless and odorless, and is produced by all engines and most heating and cooking appliances. It exists wherever fuels are burned to generate power or heat.

The most common sources of CO on boats are combustion engines, auxiliary generators, and propane or butane stoves. These produce large amounts of CO and should never be operated while sleeping. High concentrations of CO can be fatal within minutes. Many cases of CO poisoning indicate that while victims are aware they are not well, they become so disoriented they are unable to save themselves by either exiting the area or calling for help. Young children, elderly persons, and pets may be the first affected. Drug or alcohol use increases the effect of CO exposure. Individuals with cardiac or respiratory conditions are very susceptible to the dangers of carbon monoxide. CO poisoning is especially dangerous during sleep while victims are unaware of any side effects.

Low levels of CO over an extended period of time can be just as lethal as high doses over a short period. Therefore, low levels of CO can cause the carbon monoxide detector to sound before persons notice any symptoms.

Carbon Monoxide Symptoms

All engines and fuel burning appliances produce CO as exhaust. Direct and prolonged exposure to CO will cause BRAIN DAMAGE or DEATH.

Carbon monoxide (CO) poisoning is lethal and should not be confused with seasickness, intoxication, or heat exhaustion. If

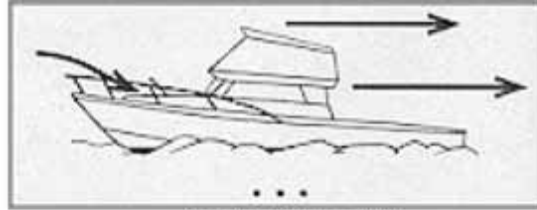

OPERATING SAFELY

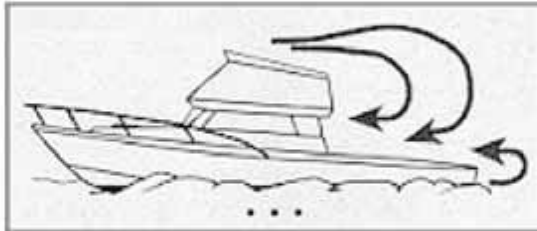

BACK DRAFTING / STATION WAGON EFFECT



NEARBY BOAT GENERATOR EXHAUST

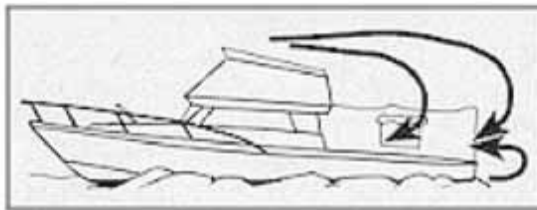

BACK DRAFTING / STATION WAGON EFFECT

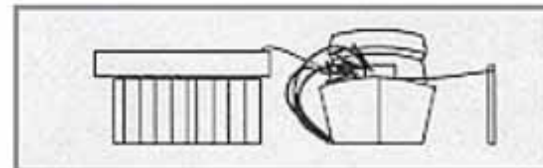

ONBOARD BOAT GENERATOR EXHAUST

someone complains of irritated eyes, headache, nausea, weakness, or dizziness, or you suspect carbon monoxide poisoning, immediately move the person to fresh air, investigate the cause, and take corrective action. Seek medical attention if necessary.

buildup of CO in the human body over several hours causes headache, nausea, and other symptoms similar to food poisoning, motion sickness, or the flu. Anyone with these symptoms should immediately be moved to an area of fresh air. Have the victim breathe deeply and seek immediate medical attention. To learn more about CO poisoning, contact your local health authorities.

DANGER

CARBON MONOXIDE (CO) HAZARD
 Exposure to CO will cause death or serious injury. CO is colorless, odorless and extremely dangerous. Avoid CO exposure and make sure the CO detector is working properly.

Preventing Carbon Monoxide Poisoning

Other symptoms that may signal exposure to CO: dizziness, flushed face, ears ringing, headaches, tightness of chest or hyperventilation, drowsiness, fatigue or weakness, inattention or confusion, lack of normal coordination, nausea, and unconsciousness. The victim's skin also may turn red. A slight

In certain situations, boats can have a problem due to the "station wagon effect" where engine exhaust fumes are captured in the vessel by the vacuum or low pressure area (usually the cockpit, helm, and cabin) that can be created by the forward speed of the boat. When underway, all aft facing port-holes, hatches, and doors should be closed. Forward-facing deck hatches should be open whenever possible to help pressurize living spaces of the boat. Sleeping, particularly

in aft cabins, should not be permitted while underway. Proper ventilation must be maintained at the helm by opening a forward window or windshield to drive fumes away from the occupants.

Use extreme caution when operating an auxiliary power generator while anchored or in a slip. Fumes can enter the boat easily on nights with calm wind. Inspect the exhaust systems of propulsion and the auxiliary generators, if equipped, frequently for possible leaks. High concentrations of CO in your boat can originate from an adjacent boat through open hatches or windows.

Failure to properly ventilate the boat while the engines are running can cause CO to accumulate within the cabin. Make sure to ventilate the boat and to avoid CO from accumulating in the boat whenever an engine is running.

Read the pamphlet *Carbon Monoxide Poisoning: What You Can't See*, included with this manual, and the owner's manual supplied by the CO detector manufacturer for additional information regarding the hazards and symptoms of CO gas, CO poisoning, and operation instructions. If you did not receive these manuals, contact Tiara Yachts Customer Relations.

CO detectors have a limited life span; follow the CO detectors manufacturers recommendations on when the detector must be replaced.

9.7 First Aid

It is the boat operator's responsibility to be familiar with proper first-aid procedures and able to care for minor injuries or illness of your passengers. In an emergency, you could be far from professional medical assistance, so be prepared. We recommend you be prepared by receiving training in basic first aid and CPR, through classes given by the American Red Cross or your local hospital.



Equip your boat with at least a simple marine first-aid kit and a first-aid manual. The marine first-aid kit should be designed for the marine environment and be well supplied. Keep it accessible so each person onboard knows where it is located. As supplies are used, replace them.

Ask a medical professional about the supplies you should carry and the safe shelf life of prescription drugs or other medical supplies you carry. Some common drugs and antiseptics can lose their strength or become unstable as they age. Replace old supplies whether they have been used or not.

In many emergency situations, the US Coast Guard can provide assistance in obtaining medical advice for treatment of serious injuries or illness. If you are within VHF range of a Coast Guard station, make the initial contact on channel 16 and follow their instructions.

9.8 Required Safety Equipment

In addition to items installed by Tiara Yachts, certain other equipment is required by the U.S. Coast Guard to help ensure passenger safety. Items like a sea anchor, working anchor, extra dock lines, flare pistol, life vests, or a line permanently secured to your ring buoy could at some time save your passengers' lives, or save your boat from damage. Visit www.uscgboating.org for a more detailed description of the required equipment and for

information about boat safety courses. Check your local and state regulations as well.

The Coast Guard Auxiliary offers a courtesy inspection that will help ensure your boat is equipped with all of the necessary safety equipment. Visit uscgboating.org for details.

The following is a list of the accessory equipment required on your boat by the U.S. Coast Guard. Requirements are subject to change.

Personal Flotation Devices (PFDs)

PFDs must be Coast Guard approved, in good and serviceable condition, and of appropriate size for the intended user. Wearable PFDs must be readily accessible, meaning you must be able to put them on in a reasonable amount of time in an emergency. Though not required, the Coast Guard emphasizes that PFDs should be worn at all times when the vessel is underway. Throwable devices must be immediately available for use. All Tiara Yachts boats must be equipped with at least one Type I, II or III PFD for each person onboard, plus one throw-able device (Type IV).

Visual Distress Signals

All Tiara Yachts boats used on coastal waters, the Great Lakes, territorial seas, and those waters connected directly to them, must be equipped with Coast Guard approved visual distress signals. These signals are either Pyrotechnic or Non-Pyrotechnic devices.

Pyrotechnic Visual Distress Signals

Pyrotechnic visual distress signals must be Coast Guard approved, in serviceable condition and readily accessible. They are marked with a date showing the service life, which must not have expired. A minimum of three are required. Some pyrotechnic signals meet both day and night use requirements. They should be stored in a cool, dry location. They include:

- Pyrotechnic red flares, hand held or aerial.
- Pyrotechnic orange smoke, hand-held or floating.
- Launchers for aerial red meteors or parachute flares.

 WARNING
<p style="text-align: center;">FIRE/EXPLOSION HAZARD</p> <p>Pyrotechnic signaling devices can cause fire and/or explosion, death, serious injury and property damage if misused. Follow the manufacturer's directions in the use of these signaling devices.</p>

 WARNING
<p style="text-align: center;">BURN HAZARD</p> <p>Fuel floating on water which is ignited can cause death or serious injury. Fuel will float on top of water and can burn. If the boat is abandoned, swim upwind, far enough to avoid fuel that can spread over the surface of the water.</p>

Pyrotechnics are universally recognized as excellent distress signals. However, there is potential for injury and property damage if not handled properly. These devices produce a very hot flame and the residue can cause burns and ignite flammable material. Pistol launched and hand-held parachute flares and meteors have many characteristics of a firearm and must be handled with caution. In some states they are considered a firearm and prohibited from use. Make sure you are careful and follow the manufacturer's instructions when using pyrotechnic distress signals.

Non-Pyrotechnic Devices

Non-Pyrotechnic visual distress signals must be in serviceable condition, readily acces-

sible, and certified by the manufacturer as complying with U.S. Coast Guard requirements. They include:

Orange Distress Flag, Day Use Only

The distress flag is a day signal only. It must be at least 3 x 3 feet with a black square and ball on an orange background. It is most distinctive when attached and waved from a paddle or boat hook.

Electric Distress Light for Night Use

The electric distress light is accepted for night use only and must automatically flash the international SOS distress signal. Under Inland Navigation Rules, a high intensity white light flashing at regular intervals from 50-70 times per minute is considered a distress signal.

Sound Signaling Devices

The navigation rules require sound signals to be made under certain circumstances. Recreational vessels are also required to sound fog signals during periods of reduced visibility. Therefore, you must have some means of making an efficient sound signal.

Navigation Lights

Recreational boats are required to display navigation lights between sunset and sunrise and other periods of reduced visibility (fog, rain, haze, etc.) Navigation lights are intended to keep other vessels informed of your presence and course. Your Tiara Yacht is equipped with the navigation lights required by the U.S. Coast Guard at the time of manufacture. It is up to you to make sure they are visible, operational and turned on when required.

9.9 Additional Safety Equipment

Besides meeting the legal requirements, prudent boaters carry additional safety equip-

ment. This is particularly important if you operate your boat offshore. You should consider the following items, depending on how you use your boat.

Satellite EPIRBs

EPIRBs (Emergency Position Indicating Radio Beacon) operate as part of a worldwide distress system. When activated, EPIRB's will send distress code homing beacons that allow Coast Guard aircraft to identify and find them quickly. The satellites that receive and relay EPIRB signals are operated by the National Oceanic and Atmospheric Administration (NOAA) in the United States. The EPIRB should be mounted and registered according to the instructions provided with the beacon, so the beacon's unique distress code can be used to quickly identify the boat and owner.

Additional equipment to consider:

- VHF Radio
- Life Raft
- Spare Anchor
- Spare Keys
- Heaving Line
- Fenders
- First Aid Kit
- Portable Radio
- Flashlight and Batteries
- Mirror
- Searchlight
- Sunburn Lotion
- Tool Kit
- Ring Buoy
- Whistle or Horn
- Anchor
- Chart and Compass
- Boat Hook
- Spare Propellers
- Mooring Lines
- Food and Water
- Binoculars
- Sunglasses
- Marine Hardware
- Extra Clothing
- Spare Parts

Operation

10.1 General

Before operating your boat, become familiar with the various component systems and their operation, and perform the Pre-Cruise Checklist found near the beginning of this manual. A thorough understanding of the component systems and their operation is essential to operate the boat safely. This owner’s manual and the associated manufacturers’ owner’s manuals have been provided to enhance your knowledge of your boat. Read them carefully.

We also recommend reading the latest edition of the book *Chapman Piloting & Seamanship*, which describes the best procedures for leaving and returning to the dock. Your boat must have the necessary safety equipment onboard and be in compliance with the U.S. Coast Guard, local and state safety regulations. There should be one Personal Flotation Device (PFD) for each person. Non-swimmers and small children should wear PFDs at all times.

You should know and understand the “Rules of the Road” and have had an experienced operator brief you on the general operation of your new boat. At least one other person should be instructed on the proper operation of the boat in case the operator is suddenly incapacitated.

For information about boating safety, regulations, and navigation rules, download the Boating Safety Mobile App from the US Coast Guard. Visit www.uscgboating.org for more information.

The operator is responsible for his or her safety and the safety of his passengers. When boarding or loading the boat, always step onto the boat, never jump. While maneuvering around the dock, have all guests on board remain in the cockpit or cabin areas, if they are not involved in the handling of mooring lines.

DO NOT allow passengers to sit on the seat backs, gunwales, bows, transoms, or sunpads when the boat is underway. Passengers should be seated to properly balance the load and must not obstruct the operator’s view, particularly to the front.

 WARNING
DROWNING OR LOSS OF CONTROL HAZARD Ejection or sudden loss of control can cause death or serious injury from improper use of seating. DO NOT stand while driving above engine idle speeds and make sure cockpit seating is locked/secured and all passengers are seated when boat is underway.

Overloading and improper distribution of weight can cause the boat to become unstable and are significant causes of accidents. Know the weight capacity and horsepower rating of your boat. Do not overload or overpower your boat.

 WARNING
OVERLOAD HAZARD Overloading the boat beyond maximum load or altering the stability, buoyancy or center-of-gravity can result in death or serious injury. DO NOT exceed the maximum load or alter the center-of-gravity of the boat.

Remember, it is the operator’s responsibility to use good common sense and sound judgment in loading and operating the boat.

 WARNING
SLIPPERY SURFACE HAZARD Wet surfaces can generate slippery conditions which can result in death or serious injury. Use caution on wet surfaces.

10.2 Homeland Security Restrictions

Recreational boaters have a role in keeping our waterways safe and secure. Violators of the restrictions below can expect a quick and severe response:

- Do not approach within 100 yards, and slow to minimum speed within 500 yards of any U.S. Naval vessel. If you need to pass within 100 yards of a U.S. Naval vessel, for safe passage you must contact the U.S. Naval vessel or the Coast Guard escort vessel on VHF-FM channel 16.
- Observe and avoid all security zones.
- Avoid commercial port areas, especially those that involve military, cruise-line or petroleum facilities.
- Observe and avoid other restricted areas near dams, power plants, etc.
- Do not stop or anchor beneath bridges or in channels.

America's Waterway Watch

America's Waterway Watch, a combined effort of the Coast Guard and its Reserve and Auxiliary, wants your help in keeping America's waterways safe and secure. America's Waterway Watch urges you to adopt a heightened sense of sensitivity toward unusual events or individuals you may encounter in or around ports, docks, marinas, riversides, beaches or waterfront communities. To report suspicious activities, call the USCG National Response Center at 1-800-424-8802. If there is immediate danger to life or property call 911 or hail the Coast Guard on marine radio channel 16.

10.3 Rules of the Road

As in driving an automobile, there are a few rules you must know for safe boating operation. The following information describes the basic navigation rules and action to be taken by vessels in a crossing, meeting or overtaking situation while operating in inland waters.

These are basic examples and not intended to teach all the rules of navigation. For further information contact the Coast Guard, Coast Guard Auxiliary, Department of Natural Resources, or your local boat club. These organizations sponsor courses in boat handling, including rules of the road. We strongly recommend such courses. Books on this subject are also available from your local library.

Crossing Situations

In the illustration below, the boat on the right has the right of way and should maintain its course and speed. The other vessel should slow down and permit it to pass. Both boats should sound appropriate signals.

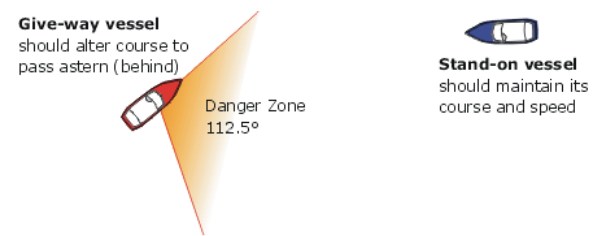

Overtaking Situations

When one motorboat is overtaking another motorboat, the boat being passed has the right of way. The overtaking boat must make adjustments necessary to provide clearance for a safe passage of the other vessel and should sound appropriate signals.



Meeting in Head-On or Nearly-So Situations

When two motorboats are approaching each other head-on or nearly head-on, neither boat has the right of way. Both boats should reduce their speed and turn to the right, passing port side to port side, providing enough clearance for safe passage. Both boats should sound appropriate signals.

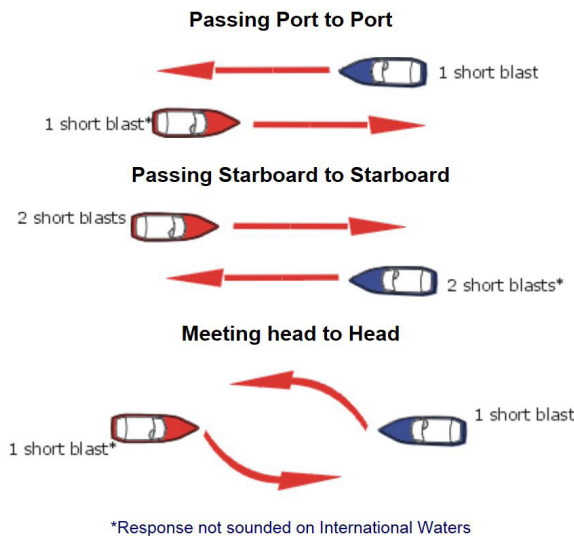

The General Prudential Rule

In obeying the Rules of the Road, due regard must be given to all dangers of navigation and collision and to any special circumstances, including the limitations of the vessels, which may justify a departure from the rules in order to avoid immediate danger or a collision.

CAUTION

Avoid collisions by following navigation rules. If a collision appears unavoidable, both vessels must act. Prudence takes precedence over right-of-way rules if a crash is imminent. Less maneuverable boats generally have the right of way. Steer clear of the right-of-way boat and pass to its stern.

Navigation Aids

Aids to navigation are placed along coasts and navigable waters as guides to mark safe water and to assist mariners in determining their position in relation to land and hidden dangers. Each aid to navigation is used to provide specific information. Become familiar with these and any other markers used in your boating area.

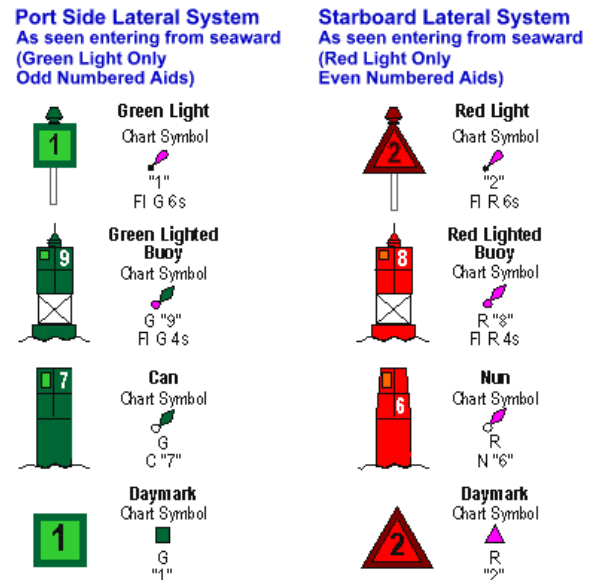

CAUTION

Storms and waves can move buoys, do not rely on buoys alone to determine your position.

10.4 Operating your Boat

Familiarize yourself with the procedures outlined in the Pre-Cruise Checklist near the beginning of this manual. Be seated and ready with the controls (steering/throttle) when the engine is started or running.

After starting the engines:

- Check engine gauges. Make sure all are reading normally.
- Visibly check engines to be sure there are no apparent water, fuel, or oil leaks.

- Check operation of engine cooling systems.
- Check controls and steering for smooth and proper operation.
- Allow engines to warm up for 10 to 15 minutes before operating them above idle speeds.
- Make sure all lines, cables, anchors, etc. for securing the boat are onboard and in good condition. All lines should be coiled, secured, and off the decks when underway.

REMEMBER:

When operating a boat, you accept the responsibility for the boat and the safety of passengers and others out enjoying the water.

- Alcohol and any mind-altering chemicals can severely reduce your reaction time and affect your better judgment.
- Alcohol reduces the ability to react.
- Alcohol makes it difficult to judge speed and distance or track moving objects.
- Alcohol reduces night vision and the ability to distinguish red from green.

STAY ALERT. The use of alcohol or any other mind-altering chemicals that impair judgment pose a serious threat to you and others. The boat operator is responsible for their consequences and the behavior of passengers.

 WARNING
<p>IMPAIRED OPERATION HAZARD Operating any boat while intoxicated or under the influence of other drugs can cause death or serious injury. DO NOT operate any boat under the influence of any mind-altering chemical.</p>

Avoid sea conditions that are beyond the skill and experience of you and your crew.

Make sure at least one other person onboard is instructed in the operation of the boat and it is operated in compliance with all state and local laws.

DO NOT operate the boat unless it is completely assembled. Make sure all fasteners are tight and adjustments are to specifications.

Before operating the boat for the first time, read the engine break-in procedures. Refer to the engine owner's manual and have your dealer describe the operating procedures for your boat. For more information, refer to the engine owner's manuals.

If the drive unit hits an underwater object, stop the engine. Inspect drive unit for damage. If damaged contact your dealer for a complete inspection and repair of the unit.

For more instructions on safety, equipment and boat handling, enroll in one of the several free boating courses offered. For information on the courses offered in your area, visit the US Coast Guard Auxiliary website, cgaux.org, and download the Boating Safety Mobile App from the US Coast Guard, www.uscgboating.org.

After stopping the boat:

- Allow engines to drop to idle speed.
- Shift controls to NEUTRAL.

 CAUTION
<p>Turn off engines at idle speed. Racing the engine before switching it off can draw water into the engine through the exhaust, resulting in internal damage.</p>

If the engines have been running at high speed for a long period of time, allow them to cool by running at idle for 3 to 5 minutes.

- Turn the ignition OFF.
- Raise the trim tabs to full UP position.

After operation:

- If operated in saltwater, wash the boat and all equipment with soap and water. Flush the engines using fresh water. Refer to the engine owner's manual for instructions on flushing.
- Check the bilge area for debris and excess water.
- Fill the fuel tanks to near full to reduce condensation. Allow room in the tanks for the fuel to expand without being forced out the vent.
- Turn off all electrical equipment except the automatic bilge pumps.
- If you are going to leave the boat unattended for a long period of time, put the battery main switches to OFF and close all seacocks.
- Make sure the boat is securely moored.

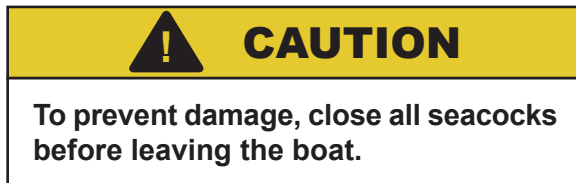

10.5 Docking, Anchoring, and Mooring

Docking and Docklines

Maneuvering a boat near a dock and securing it requires skill and techniques that are unique to water and wind conditions and the dock layout. If possible, position a crew member at the bow and stern to assist with the lines and docking. While maneuvering close to the dock, compensate for wind and current, and anticipate how you can use them to help docking. Practice in open water using an imaginary dock to develop a sense for how the boat handles in different scenarios. You must be able to understand docking techniques before problems occur.

Approaching a dock or backing into a slip in high winds or strong currents requires skill. If you are new to handling a boat, take les-

sons from an experienced pilot and learn to maneuver in tight quarters in less-than-ideal conditions. Also, practice away from the dock during windy conditions.

Dock lines are generally twisted or braided nylon. Nylon is strong and stretches to absorb shock. Nylon also has a long life and is soft and easy on the hands. The size of the line will vary with the size of the boat. Typically a 30-to-40 foot boat will use 5/8-inch line and a 20-to-30 foot boat will use 1/2-inch line. The number of lines and their configuration will vary depending on the dock, the range of the tide, and other factors. Usually a combination of bow, stern and spring lines is used to secure the boat.

Maneuvering to the Dock

Approach the dock slowly at a 30-to-40 degree angle. When possible, approach against the wind or current. Turn the engines straight and shift to neutral when you feel you have enough momentum to reach the dock. Use reverse to slow the boat and pull the stern toward the dock as the boat approaches. If you approached properly, the boat will lightly touch the pilings at the same time forward momentum is stopped. Have the dock lines ready and secure the boat as soon as it stops. Use fenders to protect the boat while it is docked. Keep the engines running until the lines are secured.

If your boat is equipped with joystick docking, consult your engine package owner's manual for additional instructions.

Backing into a Slip

Approach the slip with the stern against the wind or current and the engines straight ahead. Use the engines and turn the steering wheel to maneuver the boat into alignment with the slip. Reverse the engines and slowly back into the slip. Shift from reverse to neutral frequently at idle to prevent the boat from gaining too much speed. Move the stern right and left by shifting the engines in and out of

gear or turning the wheel. When nearly in the slip all the way, straighten the engines and shift to forward to stop. Keep the engines running until the lines are secured.

Securing Docklines

Securing a boat alongside the dock typically requires a bow and stern line and two spring lines. The bow and stern lines are usually secured to the dock at a 40 degree angle aft of the stern cleat and forward of the bow cleat. The after bow spring line is secured to the dock at a 40 degree angle aft of the after bow spring cleat. The forward quarter spring is secured to the dock at a 40 degree angle forward of the stern cleat. The spring lines keep the boat square to the dock and reduce fore and aft movement while allowing the boat to move up and down with the tide.

Securing a boat in a slip is somewhat different. It typically requires two bow lines secured to pilings on each side of the bow, two stern lines secured to the dock and two spring lines that prevent the boat from hitting the dock. The bow lines are typically secured with enough slack to allow the boat to ride the tide. The stern lines are crossed. One line runs from the port aft boat cleat to the starboard dock cleat and the other line runs from the starboard aft boat cleat to the port cleat on the dock. The stern lines center the boat, control the forward motion and allow the boat to ride the tide. Two forward quarter spring lines typically are secured to the stern cleats and to mid ship pilings or cleats. The spring lines keep the boat from backing into the dock while allowing it to ride the tide.

Leaving the Dock

Start the engines and let them warm up for 10 to 15 minutes before releasing the lines. Boats steer from the stern and it is important you achieve enough clearance at the stern to maneuver the boat as quickly as possible. Push the stern off and maneuver to gain stern clearance quickly. Proceed slowly until the boat has cleared the dock and other boats.

Mooring

Approach the mooring buoy heading into the wind or current. Shift to neutral when you have just enough headway to reach the buoy. Position a crew member on the bow to retrieve the buoy with a boat hook and secure the line. Keep the engines running until the line is secure.

Leaving a Mooring

Start the engines and let them warm up before releasing the mooring line. The boat will already be headed into the wind, so move it forward enough to loosen the line and untie it. Back the boat away until you can see the buoy and slowly move away.

Anchoring

Make sure the bitter end of the anchor rode is attached to the boat before dropping the anchor. Bring the bow into the wind or current and put the engine in neutral. When the boat comes to a stop, lower the anchor over the bow using the windlass. See section 7, Exterior Equipment. Allow enough rode so that it is at least 5 to 7 times the depth of the water and secure the line to a cleat. Use caution to avoid getting your feet or hands tangled in the line. Additional scope of 10 times the depth may be required for storm conditions. Check landmarks on shore to make sure the anchor is not dragging. If it is dragging, start over. It is prudent to use two anchors if you are anchoring overnight or in rough weather.



WARNING

SINKING OR DROWNING HAZARD
Anchoring at the stern can pull a boat under water. **DO NOT** anchor at the stern.

Releasing the Anchor

Release the anchor by traversing to the point where the anchor line becomes vertical. It should release when you pass that point. If

the anchor does not release, stop the boat directly above the anchor and tie the line to a cleat as tight as possible. The up and down movement of the boat will usually loosen the anchor. Make sure the anchor is secured and stowed before getting underway.

10.6 Controls, Steering, or Propulsion System Failure

The engine covers are machinery guards and must be in place whenever the engines are running. DO NOT operate the boat without the covers in place unless you are performing a check or maintenance.

If the propulsion, control, or steering system fails while you are operating the boat, bring both throttles to idle and shift to neutral. Determine if the boat should be anchored to prevent the boat from drifting or to hold the bow into the seas. Investigate and correct the problem if possible. Make sure the engines are off before investigating the problem. If you are unable to correct the problem, call for help.

WARNING

MOVING PARTS HAZARD

Contact with moving parts can entangle, cut, and cause death or serious injury. DO NOT come close enough to make contact with any running machinery moving parts, i.e., engine or propeller. Contact can result in loss of body parts, strangulation, burns and/or severe loss of blood resulting in serious injury or death.

In case of engine failure, you can operate the boat on one engine. Do not to apply too much power to the running engine. When running one engine to power a twin- or triple-engine boat, the engine will be ‘over propped’ and can be overloaded if too much throttle is applied. Contact your dealer or the engine

manufacturer for the maximum power settings when running on one engine.

10.7 Collision

If your boat is involved in a collision with another boat, dock, piling or a sandbar, your first priority is to check passengers for injuries and administer first aid if necessary. Once all passengers’ situations are stabilized, thoroughly inspect the boat for damage. Check below decks for leaks and ensure all control systems for proper operation. Plug all leaks or make the necessary repairs to the control systems before proceeding. Operate slowly and carefully, taking all necessary precautions to be safe. Request assistance if necessary. Haul the boat and make a thorough inspection of the hull, lower unit, and control system for damage.

10.8 Grounding, Towing, and Rendering Assistance

The law requires the owner or operator of a vessel to render assistance to any individual or vessel in distress, as long as his vessel is not endangered in the process.

If your boat should become disabled, or if another craft that is disabled requires assistance, be careful. The stress applied to a boat during towing can become excessive. Excessive stress can damage the structure and create a safety hazard for all onboard.

Freeing a grounded vessel or towing a disabled boat requires specialized equipment and knowledge. Line failure and structural damage caused by improper towing have resulted in fatal injuries. We recommend that towing be done by those with the right equipment and knowledge, e.g., the U.S. Coast Guard or a commercial towing company.

The mooring cleats or bow/stern eyes on your boat are not designed or intended to be used for towing or lifting. These cleats are designed as mooring cleats for securing the boat to a dock, pier, etc. only. DO NOT use

these fittings for towing, lifting, or attempting to free a grounded vessel.

When towing operations are underway, have everyone on both vessels stay clear of the tow line and surrounding area. DO NOT allow anyone to be in line with the tow rope; a dangerous recoil can occur if the rope should break or pull free.

Running aground can cause serious injury to passengers and damage the boat and its underwater gear. If your boat runs aground, evaluate the damage, then proceed at low speed to the nearest service facility and have an immediate inspection made before further use. A damaged boat can take on water; keep all life-saving devices close while heading to a dock area. If the boat cannot be immediately removed from the water, thoroughly inspect the bilge area for leaks.

10.9 Flooding or Capsizing

Boats can become unstable if they become flooded or completely swamped. Always be aware of the position of the boat to the seas and the amount of water in the bilge. Water entering the boat over the transom can usually be corrected by turning the boat into the waves. If the bilge is flooding because of a hole in the hull or the engine bracket, or a defective hose, you may be able to plug it with rags, close the thru-hull valve, or assist the pumps by bailing with buckets. Put a mayday call into the Coast Guard or nearby boats and distribute life jackets as soon as you discover your boat is in trouble.

If the boat becomes swamped and capsizes, you and your passengers should stay with the boat as long as you can. It is much easier for the Coast Guard, aircraft, or other boats to spot a capsized boat than people in the water.

10.10 Transporting your Boat

Your boat is large and should only be trailered by professionals with the right equipment and knowledge to transport large boats without

causing damage. Contact your dealer or the Tiara Yachts Customer Relations Department if you are planning to transport your boat and have any questions in regard to the proper equipment and support for the hull.

Damage from trailers can occur if the boat hull is not supported properly. Make sure the trailer bunks and pads are adjusted so they provide enough support for the hull and are not putting excessive pressure on the lifting strakes. Hull damage resulting from improper trailer support is not covered by the Tiara Yachts warranty.

10.11 Man Overboard

If someone falls overboard, be prepared to react quickly, especially when you are offshore.

The following procedures will help you in recovering a person that has fallen overboard:

1. Immediately stop the boat, sound a 'man overboard' alarm and have all passengers point to the person in the water.
2. Circle around quickly and throw a throwable PFD, cushion, or life jacket to the person and, if possible, throw another to use as a marker.
3. Keep the person on the driver side of the boat to keep them in sight.
4. Approach the person from the downwind side and maneuver the boat so the propellers are well clear of the person in the water.
5. Turn off the engines when the person is alongside, and assist them to the boat using a ring buoy, boat cushion with a line attached, paddle, or boathook.
6. Pull the person to the boat and assist onboard.
7. Check for injuries and administer first aid if necessary. If the injuries are serious, call for help immediately.

Refer to section 9, Safety Information, for more information on first aid and requesting emergency medical assistance.

DANGER

CARBON MONOXIDE POISONING AND/OR ROTATING PARTS HAZARD

Poisonous CO gases are present at the rear of the boat when an engine is running. A rotating propeller can cut or entangle swimmers. Either of these hazards will cause death or serious injury. DO NOT use the swim/boarding platform when the engine is running.

10.12 Trash Disposal

Under the MARPOL agreement and U.S. federal law, it is illegal for any vessel to discharge plastic or garbage that contains plastics into any waters. It is also illegal to discharge garbage in the navigable waters of the United States including the Great Lakes.

Regional, state, and local restrictions on garbage discharges also may apply. Vessels of 26 feet or longer must display, in a prominent location, a durable placard at least 4 by 9 inches notifying the crew and passengers of the discharge restrictions. Responsible boaters store refuse in bags and dispose of it properly on shore. Make sure your passengers are aware of the local waste laws and the trash management procedure on your boat.

NOTICE

Any person who violates waste disposal requirements is liable for a civil penalty of up to \$25,000, a fine of up to \$50,000, and imprisonment for up to five years for each violation. Regional, state, and local restrictions on garbage discharges also may apply.

Read *A Boater's Guide to Federal Regulations for Recreational Boating*, provided with this manual, and visit www.uscgboating.org to learn about US federal regulations regarding trash disposal. Note that local laws may vary; it is your responsibility to understand the regulations in effect in your location.

10.13 Multi-Colored Lighting

Your vessel may be equipped with multi-colored LED cockpit accent lighting and/or underwater lights. **NOTE:** Caution should be taken when using multi-colored lights at night away from the dock. Red or green lights used at night could be confusing for other boats navigating nearby. On the water, blue lights are reserved exclusively for law enforcement vessels. The use of blue lights at night in open water, combined with boat movement, could cause confusion in a potential emergency situation, and may result in a fine.

Under the MARPOL agreement and U.S. federal law, it is illegal for any vessel to discharge plastic or garbage containing plastics into any waters. Additional restrictions on dumping non-plastic waste are outlined below. All discharge of garbage is prohibited in the Great Lakes or their connecting or tributary waters. Each knowing violation of these requirements may result in a fine up to \$500,000, and up to 6 years imprisonment.

The infographic is set against a blue background representing the ocean, with a white horizon line at the top. It is divided into three vertical zones by white lines. The left zone is labeled '3 nautical miles from shore and anywhere in U.S. Lakes, Rivers, Bays, Sounds.' and contains a small white box with the text 'ILLEGAL TO DUMP Plastic All other trash'. The middle zone is labeled '3 to 12 nautical miles offshore' and contains a white box with the text 'ILLEGAL TO DUMP Plastic Dunnage, lining & packing materials that float. All other trash if not ground to less than one inch.' The right zone is labeled '12 to 25 nautical miles offshore' and contains a white box with the text 'ILLEGAL TO DUMP Plastic Dunnage, lining & packing materials that float.' To the right of this zone, another white box is labeled 'Outside 25 nautical miles offshore' and contains the text 'ILLEGAL TO DUMP Plastic'. A white box at the bottom center states 'State and local regulations may further restrict the disposal of garbage.' The background features silhouettes of a sailboat, a motorboat, and a large cruise ship. The entire infographic is framed by a red border at the top and bottom.

3 nautical miles from shore and anywhere in U.S. Lakes, Rivers, Bays, Sounds.
ILLEGAL TO DUMP Plastic
All other trash

3 to 12 nautical miles offshore
ILLEGAL TO DUMP Plastic
Dunnage, lining & packing materials that float. All other trash if not ground to less than one inch.

12 to 25 nautical miles offshore
ILLEGAL TO DUMP Plastic
Dunnage, lining & packing materials that float.

Outside 25 nautical miles offshore
ILLEGAL TO DUMP Plastic

State and local regulations may further restrict the disposal of garbage.

LET'S ALL DO OUR PART TO PROTECT THE OCEANS! 

Routine Maintenance

11.1 General

! WARNING

FIRE/EXPLOSION/ASPHYXIATION HAZARD

Cleaning agents and paint ingredients can be flammable and/or explosive, or dangerous to inhale. Make sure ventilation is adequate, wear proper personal protection, and dispose of rags properly ashore.

Vapors from flammable solvents can cause fire, explosion, or asphyxiation, resulting in death or serious injury. Keep open flame or spark away from work area. DO NOT paint unless in a well-ventilated area.

Before using a cleaning product, refer to the product directions and specifications.

If urethane foam was used in the construction of your boat, be careful with high temperatures or flames in these areas. Urethane foam can ignite. DO NOT smoke, weld, or burn. Avoid the use of space heaters and lights in areas where urethane foam is present. If ignited, urethane foam burns rapidly, produces extreme heat, releases hazardous gases, and consumes much oxygen.

11.2 Exterior Hull and Deck

The exterior of your Tiara Yacht is made up of many different materials and finishes. Each material should be maintained by following the recommendations in the appropriate user manual.

After each use:

- Rinse the boat exterior with clean, fresh water.
- Wash all exterior surfaces and hardware with a sponge or soft bristle brush and a solution of fresh water and mild deter-

- gent. Nonskid areas may be scrubbed with a stiff bristle brush.
- Rinse the boat with fresh water.

Apply a premium marine wax to all smooth (gel coat and/or painted) fiberglass surfaces at least once a year. Follow the directions supplied with the wax.

! NOTICE

Do not use abrasive cleaners on smooth fiberglass surfaces. They will dull the surface and allow dirt to penetrate the surface.

Most of the shiny white surfaces on your Tiara Yacht are gel coated. The deck, hardtop exterior and swim platform are a few examples. Depending on the build of your boat, the hull sides may be gel coated with a painted boot line or entirely painted. If you are unsure about your boat's finishes, contact your Tiara Yachts dealer.

Gel Coat

Time and exposure to sunlight may cause the gel-coated surfaces to fade, dull, or chalk. Regular applications of a premium marine wax will minimize this. If you find a noticeable chalking of the gel coat you may choose to have it buffed to bring back the original luster. We recommend contacting your Tiara Yachts dealer or other marine service facility if your finish needs attention.

! CAUTION

Experience is required to buff your boat. Do not buff your boat unless you have been properly trained and are using an industrial strength buffer with the appropriate pads and polishing materials.

After buffing, apply a coat of premium marine wax to all smooth surfaces, following the

instructions included with the wax. Refer to the gel coat care card that came with your boat.

If the fiberglass or gel-coated surface should need repair, contact your Tiara Yacht dealer or another qualified marine service facility.

Axalta Marine Finish (optional)

Axalta® polyurethane marine finishes provide superior protection against the elements your boat will face throughout its long life. To ensure you maximize the benefits of the finish, use the following guide. If you are unsure about your boat's finishes, contact your Tiara Yachts dealer.

To maintain your painted hull finish:

- During the first 30 days following the boat's manufacture, when the finish is still fresh, clean the boat with a water rinse only.
- Do not wax for the first 60 days following the boat's manufacture.
- Do not use a pressure washer for the first 60 days following the boat's manufacture. Using high pressure while the paint is still fresh could affect the finish. Also avoid high pressure too close to areas with visible chips or cracks.
- Wash your boat often, especially when exposed to dusty, acidic or alkaline environments.
- When washing your boat, use non-abrasive, neutral pH (non acidic or alkaline) detergent. Do not use solvent-based solutions for washing.
- Do not wash the boat with extremely hot water or while the surface is hot.
- Avoid washing with stiff bristles. Soft cloth and soft brushes are recommended.
- Do not allow spilled gasoline, oil, anti-freeze, hydraulic fluid, or windshield washer fluid to sit on the paint or gel coat; remove immediately by rinsing with water. With some oils and hydraulic fluids, the allowable exposure time before

staining occurs is significantly shortened if the fluid or the painted surface is hot.

- Have any paint chips, nicks, or scratches repaired as soon as they occur to protect against future degradation.
- Should your boat's finish become damaged, have it repaired as soon as possible. Contact your Tiara Yachts dealer or a marine service facility and specify the same polyurethane marine finish as used for the original finish.

Bottom Painting

If your boat has not been ordered with factory-applied bottom paint, and will be kept in the water for three weeks or more at a time, the bottom should be painted with an antifouling paint. Because of variations in water temperature, marine growth and pollution in different regions, your Tiara Yachts dealer and/or a qualified boat yard in your area should be consulted when deciding what bottom paint system to apply to your hull, because pollution and marine growth can damage fiberglass hulls.

If your boat is equipped with a factory-applied first coat of bottom paint, a second coat should be applied over the first, just before launching. Paint has been provided by Tiara for this purpose. Follow the paint manufacturer's recommendations for preparation and application. Applying the second coat right before launching maximizes the paint's anti-fouling properties.

Sanding or sandblasting the hull bottom will damage the fiberglass. When preparing the hull for bottom paint, use only standard antifouling paints and fiberglass wax removers and primers recommended by the antifouling paint manufacturer. Sanding or sandblasting and the use of a coating other than standard antifouling paint or epoxy barrier coatings are not recommended and will void the hull blister warranty.

DO NOT allow antifouling paint to contact the outboard engines. Most antifouling paints

contain copper which will cause severe galvanic damage to the motor. Leave a 1/2" (12.7 mm) barrier between the hull bottom paint and outboard engine.

Most bottom paints require maintenance, especially when the boat is in saltwater or not used for extended periods, or after dry storage. If the hull bottom has been painted with antifouling paint, contact your dealer for the recommended maintenance procedures.

Sacrificial Anodes

Sacrificial zinc anodes are installed on the trim tabs, transom, and outboard engines. The transom anode is connected to the bonding system and protects the underwater hardware that is bonded.

The anodes are less noble than copper-based alloys and aluminum and will deteriorate first, protecting the more noble underwater hardware against galvanic corrosion. Anodes should be checked monthly and changed when they are 75% of their original size. When replacing the anodes, make sure the contact surfaces are clean, shiny metal and free of paint and corrosion. Never paint over the anode or protect it.

Boats stored in saltwater will require anodes to be replaced at least every 6 months to one year. Anodes requiring replacement more frequently may indicate a stray current problem within the boat or at the slip or marina. Anodes that do not need to be replaced after one year may not be providing the proper protection. Loose or low quality anodes could be the problem. Contact your Tiara Yachts dealer for the proper size and type of anodes to be used and the specific installation procedure.

Fiberglass Gelcoat Surfaces

Normal maintenance requires only washing with mild soap and water. A stiff brush can be used on the nonskid areas. Kerosene or commercially prepared products will remove

oil and tar which could be a problem on trailered boats. DO NOT use harsh abrasive and chemical cleaners because they can damage or dull the gelcoat, reducing its life and making it more susceptible to stains. When the boat is used in saltwater, wash it thoroughly with soap and water after each use.

Sudden changes in temperature can affect gelcoat. When planning on moving your boat from outdoors to a heated location, allow the change of temperature to be gradual. Warm the location slowly after the boat is brought inside to allow the boat to change temperature slowly as the location is warmed. Or, if you are moving your boat from a warmer area to a colder one, wait for the temperature to be closer to the temperature of the warmer area or allow the warmer area and the boat to cool down.

At least once a season, wash and wax all exposed fiberglass surfaces. Use a high quality automotive or boat wax. Follow the procedure recommended by the wax manufacturer. Washing and waxing of your boat will have the same beneficial effects as they have on an automobile finish. The wax will fill minute scratches and pores, which helps prevent soiling and will extend the life of the gelcoat.

After the boat is exposed to the direct sunlight for a period of time, the color in the gelcoat will tend to fade, dull, or chalk from oxidation of the gel. This condition will be more apparent with dark colors, which require more frequent maintenance. A heavier buffing is required to bring the gelcoat back to its original luster. For power cleaning, use a light cleaner. To clean the boat by hand, use a heavier automotive cleaner. Before cleaning the surfaces, read the instructions given with the cleaner. After cleaning the surfaces, apply wax and polish all fiberglass surfaces except the nonskid areas.

If the fiberglass should become damaged and need repair, contact your Tiara Yachts dealer or an authorized repair person.

**WARNING****SLIPPERY SURFACE HAZARD**

Cleaning surfaces can generate slippery conditions which can result in death or serious injury. Use caution when cleaning with detergents. Rinse thoroughly.

Be careful when walking on wet gelcoat surfaces.

DO NOT wax nonskid surfaces, which could make them slippery and increase the possibility of injury.

Stainless Steel Hardware

When using the boat in saltwater, wash hardware with soap and water after each use. When your boat is used in a more highly corrosive environment—such as saltwater, water with a higher sulfur content, or polluted water—stainless steel may develop surface rust stains. This is normal under these conditions.

Clean and protect by using a high quality boat or automotive wax or a commercial metal cleaner and protectant. DO NOT use citrus-based or abrasive materials such as sandpaper, bronze wool, or steel wool on stainless steel, or damage will result.

Powder Coated (Painted) Aluminum Surfaces

Regular care is necessary to maintain the appearance of the powder coat finish. Build-up of salt and grime can hold moisture and damage powder coatings. This buildup can cause a corrosive condition that can damage the coating, especially in a salt air or coastal environment.

- Wash the finish regularly with warm water containing a pH neutral detergent (i.e. mild dish soap).
- Use a non-abrasive fiber cloth
- Rinse thoroughly after cleaning

Chrome Hardware

Rinse with fresh water and wipe dry with a towel or chamois after each use. Use a good chrome cleaner and polish on all chrome hardware. Clean and wax chrome prior to extended storage. In saltwater or other harsh environments, clean and wax more often.

Acrylic Plastic

Acrylic plastic scratches easily. DO NOT use a dry cloth or glass cleaning solutions on acrylic. Use a soft cloth and mild soap and water for routine cleaning. Solvents and products containing ammonia (including glass cleaners such as Windex®) can permanently damage acrylic plastic.

Fine scratches can be removed with a fine automotive clear-coat polishing compound. A coat of automotive or boat wax is beneficial to protect the surface.

**NOTICE**

Acrylic plastic scratches easily. Use a soft cloth and mild soap and water for routine cleaning. DO NOT use a dry cloth, abrasives, or glass cleaning solutions on acrylic. Solvents and products containing ammonia can permanently damage acrylic plastic.

DO NOT use the following on acrylic plastic:

- Abrasive cleaners
- Acetone
- Alcohol
- Cleaners containing ammonia
- Glass cleaners
- Solvents

Engines

Proper engine maintenance is essential to the performance and reliability of your outboard engines. Maintenance schedules and

procedures are outlined in your engine owner's manual; follow them exactly.

Flush the system when the boat is out of the water. Flush daily if used in saltwater.

The age of the gasoline in your tank can affect engine performance. Chemical changes occur as the gasoline ages, causing deposits and varnish in the fuel system and reducing the octane rating of the fuel. Degraded fuel can damage the engine and boat fuel tank and lines. If your boat does not require at least one full tank of fresh fuel a month, add a fuel stabilizer to the gasoline to protect the fuel from degradation. Use only a fuel stabilizer recommended by your Tiara Yachts dealer or the engine manufacturer. Operate the boat at least 15 minutes after adding the stabilizer to allow the treated fuel to reach the engine. Your dealer or engine manufacturer can provide additional information on fuel degradation. For more recommendations for your specific area, check with your local Tiara Yachts dealer.

Avoid using fuels with alcohol additives. Gasoline, extended with an alcohol blend, will absorb moisture from the air which can reach such concentrations that "phase separation" can occur, where the water and alcohol mixture becomes heavy enough to settle out of the gasoline to the bottom of the tank. Since the fuel pick-up tube is near the bottom of the tank, phase separation can cause the engine to run poorly or not at all. This condition is more severe with methyl alcohol and will worsen as the alcohol content increases. Water or a jelly like substance in the fuel filters is an indication of possible phase separation from the use of alcohol blended fuels.

Contact your Tiara Yachts dealer or engine manufacturer for additional information regarding fuels and additives.

Corian Surfaces

Corian® is resistant to heat, but you should always use a hot pad or a trivet with rubber feet to protect it. Avoid exposing Corian to

strong chemicals, such as paint removers, oven cleaners, etc. If contact occurs, flush the surface with water immediately. Soapy water or ammonia-based cleaners will remove most dirt and stains from all types of finishes.

DO NOT use the Corian countertop as a cutting board.

Minor damage, scratches, general or chemical stains, scorching or burns and minor impact marks can be repaired on-site with a light abrasive cleanser and a product such as a Scotch-Brite® pad. For heavier damage, light sanding may be necessary. Heavy damage should be repaired by a Corian-licensed professional.

11.3 Seats and Upholstery

Seat Slides and Swivel Bases

Perform the following periodically:

- Inspect and tighten mounting screws between seat slides and seat bottom.
- Inspect and tighten the mounting screws attaching the seat bases to the boat.
- Keep a light film of grease on manual seat slides.
- Keep a light film of grease on manual seat-adjusting mechanisms.
- Clean electric seat slides. DO NOT use harsh chemicals or abrasives. Lubrication is not required.

Vinyl Upholstery

The vinyl upholstery used on the exterior seats and bolsters and the cabin headliner should be cleaned with soap and water periodically. Stains, spills or soiling should be cleaned up immediately to prevent the possibility of permanent staining. When cleaning, rub gently. DO NOT use products containing ammonia, powdered abrasive cleaners, steel wool, strong solvents, acetone, and lacquer solvents or other harsh chemicals as they can permanently damage or shorten the life of vinyl. Never use steam heat, heat guns, or hair dryers.

Stronger cleaners, detergents, and solvents may be effective in stain removal, but can cause either immediate damage or slow deterioration. Lotions, sun tan oil, waxes, and polishes, etc., contain oils and dyes that can cause stiffening and staining of vinyls. To clean common stains, follow these recommendations:

- Dry soil, dust and dirt: remove with a soft cloth.
- Dried-on dirt: wash with a soft cloth dampened with water.
- Variations in surface gloss: wipe with a water-dampened soft cloth and allow to air dry.
- Stubborn dirt: wash with a soft cloth, dampened with a delicate laundry soap and water. Rinse with clean water.
- Stubborn spots and stains: spray with Fantastik Cleaner® or Tannery Car Care Cleaner® and rub with a soft cloth. Rinse with clean water.
- Liquid spills: wipe with a clean absorbent cloth immediately. Rinse with clean water.
- Food grease and oily stains: spray with Fantastik Cleaner or Tannery Car Care Cleaner, wiping with a soft cloth immediately. Be careful not to extend the area of contamination beyond its original boundary. Rinse with clean water.

11.4 Cabin Interior

Clean the cabin interior just like you would clean a home interior. Use wood cleaner on teak woodwork and a vacuum cleaner on carpeting.

Air and sunlight are very good cleansers. Periodically, place cushions, bedding, etc., on deck, under the sun and in the fresh air to dry and air out. If cushions or equipment get wet with saltwater, remove and use clean, fresh water to rinse off the salt crystals. Salt retains moisture and will cause damage. Dry thoroughly and reinstall.

If you leave the boat for a long period of time, open all interior cabin and locker doors and

hang a mildew protector in the cabin. Read the label on the mildew protector carefully and follow instructions. Remove the protector from the cabin and allow the cabin to ventilate completely before using the cabin again.

11.5 Bilge

To keep the bilge clean and fresh, use a commercial bilge cleaner regularly. Follow the directions carefully. All exposed pumps and metal components should be sprayed with a protector periodically to reduce the corrosive effects of high humidity.



WARNING

FIRE/EXPLOSION OR ASPHYXIATION HAZARD

Fumes from flammable solvents can cause fire, explosion, or asphyxiation resulting in death or serious injury. DO NOT use flammable solvents to clean the bilge.

11.6 Electrical

The AC and DC electrical systems require routine maintenance. See section 4, Electrical Systems, for more information.

11.7 Generator

The engine maintenance required on the generator is similar to an inboard engine. The engine incorporates a pressure-type lubrication system and a fresh-water-cooled engine block which is thermostatically controlled. The most important factors affecting the longevity of the generator are proper ventilation and maintenance of the fuel system, ignition system, cooling system, lubrication system, and AC alternator.

Maintenance schedules and procedures are outlined in the generator owner's manual; follow them exactly.

Seasonal Maintenance

12.1 Winterizing

Engines

Refer to the engine owner’s manual for detailed information on preparing the engines for storage.

Fresh Water System

The entire fresh water system must be completely drained. Disconnect all hoses, check valves, etc., and blow all the water from the system. Make sure the water heater and fresh water tank are completely drained. Use only very low air pressure when blowing water from the system in order to prevent damage to components. The check valve mechanism built in the fresh water pump will not remove the water from the pump. Remove the outlet hose on the pump, turn it on, and allow it to pump out any remaining water (approximately a cupful).

Before storing your boat, the water system needs to be drained and winterized.

 **WARNING**

Hot water will cause burns. Do not drain the freshwater system until water in the water heater tank (if installed) is cool.

 **CAUTION**

Do not operate the water heater without water in the water heater tank. Failure to do so could damage the water heater.

To drain the fresh water system:

1. Switch OFF the WATER HEATER breaker on the AC distribution panel, if installed.

2. Open all fresh water faucets (hot and cold). Leave the faucets open.
3. Switch ON the FRESH WATER breaker(s) on the DC distribution panel.
4. Allow the water to run until the tank is empty. The tank is empty when all faucets no longer produce a stream of water.
5. Switch OFF the FRESH WATER breaker(s).
6. Remove the hoses from the input and output sides of the fresh water pump(s), and let the pump(s) and hoses drain into the bilge. The fresh water pump(s) are located in the mechanical space.
7. Switch ON the FRESH WATER breaker(s) for 3-5 seconds to remove the water from the bottom of the pump housing(s). Turn OFF the FRESH WATER breaker(s).
8. If installed, drain all water from the water heater. Refer to section 5, Plumbing Systems, and the water heater user manual for the draining procedure.

Next, flush the system with potable water antifreeze:

1. Close all fresh water system faucets.
2. Reconnect the hoses to the water pumps.
3. If an optional ice maker is installed:
 - Disconnect the ice maker water supply and plug the supply line.
 - Switch ON the ICE MAKER breaker on the AC distribution panel.
 - Allow the unit to run for an hour.
 - Remove any cubes that may have been ejected during this period.
 - Switch OFF the breaker and prop the ice maker door open to let the unit defrost.
 - After the ice maker has defrosted, wipe it dry.

NOTE: At no time should potable water antifreeze be allowed to enter the ice maker. Follow the ice maker user manual for winterization procedure.

4. Pour five (5) gallons of potable water antifreeze into the water tank via the WATER fill fitting(s) on the gunwale(s).
5. Turn both water heater valves (if installed) fully counter-clockwise to the bypass position.
6. Switch ON the FRESH WATER breaker(s) on the DC distribution panel.
7. Open all faucets in the system (hot and cold), one at a time, until the antifreeze begins to come out, and then close.
8. Switch OFF the FRESH WATER breaker(s).

An alternate method is to use commercially available nontoxic, fresh water system antifreeze. After draining the potable water tank, lines and water heater (if installed), pour the antifreeze mixture into the fresh water tank, then prime and operate the pump until the mixture flows from all fresh water faucets. Be sure to open ALL faucets, including the water supply valve for the head. Make sure antifreeze has flowed through all of the fresh water drains. Allow the antifreeze to fill the sink traps.

The shower/cabin drain sump system must be winterized also. Clean debris from the drain and sump and flush for several minutes with fresh clean water. After the system is clean, pump the drain sump as dry as possible. Then pour a potable water antifreeze mixture into the shower drain until antifreeze has been pumped through the entire system and out of the thru-hull.

For additional information, refer to section 5, Plumbing Systems.

Raw Water System

Drain the raw water systems completely. Disconnect all hoses and blow the water from the system. Use only very low air pressure when blowing water from the system to prevent damage to components. The check valve mechanism built into the raw water washdown pump will not remove the water from the pump. Remove the outlet hose on the pump, turn it on, and allow it to pump out

any remaining water (approximately a cupful).

An alternate method is to use commercially available nontoxic, potable water system antifreeze. If antifreeze is used, pour the mixture into a pail and put the raw water intake lines into the solution. Turn on the raw water washdown pump using the WASHDOWN PUMP breaker on the DC distribution panel, located in the port companionway upper electrical cabinet. Run the pump until the antifreeze solution is visible at all raw water faucets, discharge fittings, and drains. Make sure antifreeze has flowed through all of the raw water drains.

Generator Raw Water Systems

If a generator is installed on your Tiara Yacht, drain the sea strainer, heat exchangers, and raw water supply and discharge lines for the generator raw water supply pumps. Make sure all sea water has drained from the exhaust system. Some generator engine mufflers have a drain plug that must be removed to properly drain the muffler.

Once the exhaust system has been drained, pour a nontoxic marine engine antifreeze mixture into a large pail and put the generator raw water intake lines into the solution. Run the generator until the antifreeze solution is visible at the exhaust port, then shut the engine off.

Winterize the generator engine and fuel system by following the generator manufacturer's winterizing procedures. Refer to generator's owner's manuals or contact a Tiara dealer.

Fuel System

Leave the fuel tank nearly full to reduce condensation that can accumulate in the tank. Allow enough room for fuel to expand without leaking from the vents.

Algae can grow in the accumulated water in diesel fuel tanks, especially in warm climates. Adding a high quality diesel fuel additive con-

taining an algaecide may be required to control algae during storage.

Marine Toilet

Pump out the head. Flush the holding tank using clean soap, water, deodorizer, and pump-out cleaning solution.

Refer to the toilet owner's manual and winterize the toilet following the procedures exactly. Drain the intake and discharge hoses completely using low air pressure if necessary. The head holding tank and macerator discharge pump must be pumped dry. Pour one gallon of potable water antifreeze into the tank through the deck waste pumpout fitting. After the antifreeze has been added to the holding tank, open the overboard discharge valve and activate the macerator pump until the antifreeze solution is visible at the discharge thru-hull.

Air Conditioner

Disconnect and drain the air conditioner intake and discharge hoses. Remove all water from the sea strainer and thru-hull fitting. Allow all water to drain from the system. An alternate method is the use of commercially available nontoxic, potable water system antifreeze. If antifreeze is used, drain the sea strainer and pour the mixture into a pail and put the raw water intake line into the solution. Run the air conditioner until the antifreeze solution is visible at the discharge fitting on the hull side.

Air conditioner components must be winterized also; follow winterizing procedure in the air conditioner owner's manual.

Bilge

The bilge pumps and bilge pump lines must be completely free of water and dried out when the boat is laid up for the winter in climates where freezing occurs. Compartments in the bilge that will not drain completely should be pumped out and then sponged until completely free of water. Dry the hull bilge

and self-bailing cockpit troughs. Water freezing in these areas could cause damage. Coat all metal components, wire busses, connector plugs (in the bilge), strainers, seacocks, and steering components with a protecting oil. Wipe the bilge areas clean and dry.

Covering for Winter Storage

Proper storage is very important to prevent serious damage to the boat. If the boat is stored outside, support and secure a storage cover properly over the boat. It is best to have a frame built over the boat to support the cover. It should be a few inches wider than the boat so the cover will clear the rails and allow passage of air. If this cover is fastened too tightly there will be inadequate ventilation, which can lead to mildew, moisture accumulation, etc. Fasten the cover down securely so wind cannot remove it or cause chafing of the hull superstructure. DO NOT store the boat in a damp storage enclosure. Excessive dampness can cause electrical problems, corrosion, and excessive mildew.

DO NOT use the bimini top or convertible top cover in place of the winter storage cover. The life of these tops can be shortened if exposed to harsh weather elements for long periods.

DO NOT use an electric or fuel burning heating unit in the bilge area.

If the boat is to be stored indoors, make sure the building has enough ventilation and there is enough ventilation both inside the boat and around the boat. If the boat is to be stored indoors or outdoors, open all drawers, clothes lockers, cabinets, and interior doors a little. If possible, remove the upholstery, mattresses, clothing, and rugs.

12.2 Storage and Lay-up

It is essential that care be used when lifting your boat. Make sure the spreader bar at each sling is at least as long as the distance across the widest point of the boat that the sling will surround. The sling positions are

marked with small labels on each side of the boat under the rubrails. Tie fore and aft slings together to prevent slings from sliding on the hull.

Elevating lifts are commonly used to store boats for extended periods. To provide proper support, the bunks that support the hull should be aligned with and run parallel to the hull stringers. The bow and stern eyes, if equipped, should not be used as sole support for storage.

Your boat can be damaged from improper lifting and rough handling when being transported by lift trucks. Care and proper handling procedures must be used when using a lift truck to move your boat. DO NOT attempt to lift the boat with a substantial amount of water in the bilge.

CAUTION

Failure to follow the proper lifting procedures while lifting your boat may result in structural damage to the hull and deck or underwater gear.

Severe gelcoat cracking or more serious hull damage can occur during hauling and launching if pressure is created on the gunwales (sheer) by the slings. Use flat, wide slings and spreaders long enough to keep pressure from the gunwales. DO NOT allow your boat to be hauled when the spreaders on the lift are not wide enough to take the pressure off the gunwales.

To prepare the boat for storage:

- Remove the bilge drain plug(s), if installed.
- Thoroughly wash the fiberglass exterior, especially the antifouling portion of the bottom. Remove as much marine growth as possible. Lightly wax the exterior fiberglass components.
- Remove all oxidation from the exterior hardware and apply a light film of mois-

ture-displacing lubricant.

- Remove propellers and grease the propeller shafts using light waterproof grease.
- Remove batteries and clean using clear, clean water. Make sure batteries have sufficient water and terminals are clean. Keep the batteries charged and stored in a cool, dry place and safe from freezing. See section 4, Electrical Systems, and the battery owner's manual for more information.
- Follow the AC and DC electrical systems maintenance instructions in section 4, Electrical Systems.
- Coat all faucets and exposed electrical components in the cabin and cockpit with a protecting oil.
- Thoroughly clean the interior of the boat; vacuum all carpets and dry-clean upholstery.
- Remove cushions
- Open the refrigerator/cooler door and as many locker doors as possible. Leaving as many of these areas open as possible will improve fresh air ventilation during the storage period.
- Place a mildew preventive system in the cabin area before it is closed for storage.
- Clean the exterior upholstery with a good vinyl cleaner, and dry thoroughly. Spray the weather covers and boat upholstery with a spray disinfectant. Enclosed areas such as the refrigerator, shower basin, storage locker areas, etc., should also be sprayed with a disinfectant.

Supporting the Boat for Storage

A trailer, elevating lift, or well-made cradle is the best support for your boat during storage. When storing the boat on a trailer for a long period:

- Make sure the rollers and pads support the hull of the boat and the trailer is on a level surface with the bow high enough so water will drain from the bilge and cockpit. The trailer must properly support the hull. The bunks and rollers should

- match the bottom of the hull and should not put pressure on the lifting strakes.
- Make sure the hitch is properly supported.
- Check the tires once each season. Add enough air for the correct amount of inflation for the tires.
- Make sure the engines are in the down position.

Custom-made cradles, with protective padding on the bunks, are available through your Tiara Yachts dealer.

When storing the boat on a lift or cradle:

- The cradle must be specific for boat storage. Make sure the lift or cradle is well-supported with the bow high enough to provide proper drainage of the bilge. The cradle or lift must be in the proper fore and aft position to properly support the hull. When the cradle or lift is in the correct location, the bunks should match the bottom of the hull and should not be putting pressure on the lifting strakes.
- Make sure the engines are in the down position.
- Make sure bunks and rollers are adjusted so they are not putting pressure on the lifting strakes and are providing enough support for the hull. Hull damage resulting from improper cradle or trailer support is not covered by the Tiara warranty.

12.3 Recommissioning

DO NOT operate the boat unless it is completely assembled. Keep all fasteners tight. Keep adjustments according to specifications.

Before launching the boat, make sure to install hull drain plug(s).

Recommissioning the boat after storage:

- Charge and install the batteries.
- Install hull drain plug(s).

- Check the bilge area and all thru-hulls and seacocks to ensure there are no leaks.
- Open all seacocks and make sure the hoses and fittings are not leaking.
- Verify all bilge pumps are operational by manually activating the float switch at each pump.
- Check the engines and generator for damage and follow the manufacturer's instructions for recommissioning.
- Check the mounting bolts of engines to make sure they are tight.
- Perform all routine maintenance.
- Check all hose clamps for tightness.
- Pump antifreeze from any systems winterized with antifreeze and flush several times with fresh water. Make sure all antifreeze is flushed from the water heater (if installed) and it is filled with fresh water before it is activated. Disinfect the fresh water system. Refer to section 5, Plumbing Systems, for instructions.
- Check and lubricate the steering system.
- Clean and wash the boat.
- Install all upholstery, cushions, and canvas.

After launching:

- Check all water systems and the engine mounting bolts for leaks. Operate each system one at a time and check for leaks and proper operation.
- Make sure all BILGE pump switches are ON.
- When the engines start, check the cooling system port below the engine cowling for a strong stream of water to ensure cooling pump is operating.
- Carefully monitor the gauges and check for leakage and abnormal noises.
- Operate the boat at slow speeds until the engine temperature stabilizes and all systems are operating normally.

Aft: In, near, or toward the stern of a boat.

Aground: A boat stuck on the bottom.

Amidships: In or toward the part of a boat midway between the bow and stern.

Anchor: A specially shaped heavy metal device designed to dig efficiently into the bottom under a body of water and hold a boat in place.

Anchor locker: a locker, usually located in the bow of a boat, used for stowing the anchor line or chain

Anchorage: An area specifically designated by governmental authorities in which boats may anchor.

Ashore: On shore.

Astern: Behind the boat, to move backwards.

Athwartship: At right angles to the center line of the boat.

Barnacles: Small, hard-shelled marine animals which are found in salt water attached to pilings, docks and bottoms of boats.

Beam: The breadth of a boat usually measured at its widest part.

Beamy: boats of greater than normal beam

Bearing: The direction of an object from the boat, either relative to the boat's direction or to compass degrees.

Berth: A bunk or a bed on a boat.

Bilge: The bottom of the boat below the flooring.

Bilge Pump: A pump that removes water that collects in the bilge.

Boarding: Entering or climbing into a boat.

Boarding Ladder: Set of steps temporarily fitted over the side of a boat to assist persons coming aboard.

Boat Hook: Short shaft of wood or metal with a hook fitting at one end shaped to aid in extending one's reach from the side of the boat.

Bow: The front end of a boat's hull.

Bow Line: A line that leads forward from the bow of the boat.

Bow Rail: Knee high rails of solid tubing to aid in preventing people from falling overboard.

Bridge: The area from which a boat is steered and controlled.

Bridge Deck: A deck forward and usually above the cockpit deck.

Broach: When the boat is sideways to the seas and in danger of capsizing; a very dangerous situation that should be avoided.

Bulkhead: Vertical partition or wall separating compartments of a boat.

Cabin: Enclosed superstructure above the main deck level.

Capsize: When a boat lays on its side or turns over.

Chapman's: Chapman Piloting & Seamanship, by Chapman and Jonathon Eaton; published by Hearst.

Chain locker: See anchor locker.

Chock: A deck fitting, usually of metal, with inward curving arms through which mooring or anchor lines are passed so as to lead them in the proper direction both onboard and off the boat.

Cleat: A deck fitting, usually of metal with projecting arms used for securing anchor and mooring lines.

Closed Cooling System: A separate supply of fresh water that is used to cool the engine and circulates only within the engine.

Coaming: A vertical piece around the edges of cockpit, hatches, etc., to stop water on deck from running below.

Cockpit: An open space, usually in the aft deck, outside of the cabin.

Companionway: Opening in the deck of a boat to provide access below.

Compartment: The interior of a boat divided off by bulkheads.

Cradle: A framework designed to support a boat as she is hauled out or stored.

Cutlass Bearing: A rubber bearing in the strut that supports the propeller shaft.

Deck: The floor-like platform of a boat that covers the hull.

Displacement: The volume of water displaced by the hull. The displacement weight is the weight of this volume of water.

Draft: The depth of water a boat needs to float.

Drydock: A dock that can be pumped dry during boat construction or repair.

Dry Rot: A fungus attack on wood areas.

Electrical Ground: A connection between an electrical connector and the earth.

Engine Beds: Sturdy structural members running fore and aft on which the inboard engines are mounted.

EPIRB: Emergency Position Indicating Radio Beacon. Operates as a part of a worldwide satellite distress system.

Even Keel: When a boat floats properly as designed.

Fathom: A measure of depth. One Fathom = 6 feet.

Fender: A soft object of rubber or plastic used to protect the topsides from scarring and rubbing against a dock or another vessel.

Fend off: To push or hold the boat off from the dock or another boat.

Flying Bridge: A control station above the level of the deck or cabin.

Flukes: The broad portions of an anchor which dig into the ground.

Following Sea: A sea that comes up from the stern and runs in the same direction that the boat is going.

Fore: Applies to the forward portions of a boat near the bow.

Foundering: When a boat fills with water and sinks.

Fuel pump: feeds fuel under pressure

Freeboard: The height from the waterline to the lowest part of the deck.

Galley: The kitchen of a boat.

Grab Rail: Hand-hold fittings mounted on cabin tops or sides for personal safety when moving around the boat, both on deck and below.

Ground Tackle: A general term including anchors, lines, and other gear used in anchoring.

Grounds: A boat touches the bottom.

Gunwale: The upper edge of a boat's side.

Hand Rail: Rail mounted on the boat, for grabbing with your hand, to steady you while walking about the boat.

Harbor: An anchorage which provides reasonably good protection for a boat, with shelter from wind and sea.

Hatch: An opening in the deck with a door or lid to allow for access down into a compartment of a boat.

Head: A toilet on a boat.

Heat Exchanger: Used to transfer the heat that is picked up by the closed cooling system to the raw cooling water.

Helm: The steering and control area of a boat.

Hull: The part of the boat from the deck down.

Inboard: A boat with the engine mounted within the hull of the boat. Also refers to the center of the boat away from the sides.

Inboard/outboard: Also stern drive or I/O. A boat with an inboard engine attached to an outboard drive unit.

Keel: A plate or timber plate running lengthwise along the center of the bottom of a boat.

Knot: Unit of speed indicating nautical miles per hour. 1 knot = 1 nautical mile per hour (1.15 miles per hour). A nautical mile is equal to one minute of latitude: 6076 feet. Knots times 1.15 equals miles per hour. Miles per hour times .87 equals knots.

Lay-up: To decommission a boat for the winter (usually in northern climates).

Leeward: The direction toward which the wind is blowing.

Length On The Waterline (LWL): A length measurement of a boat at the waterline from the stern to where the hull breaks the water near the bow.

Length Overall (LOA): a length measurement of a boat from the fore part of the stem to the after part of the stern

Life Preserver: provides additional buoyancy to keep a person afloat when he/she is in the water

Limber Hole: A passage cut into the lower edges of floors and frames next to the keel to allow bilge water to flow to the lowest point of the hull where it can be pumped overboard.

Line: The term used to describe a rope when it is on a boat.

Lists: A boat that inclines to port or starboard while afloat.

Locker: A closet, chest or box aboard a boat.

Loran: An electronic navigational instrument which monitors the boat's position using signals emitted from pairs of transmitting stations.

Lunch hook: A small light weight anchor typically used instead of the working anchor. Normally used in calm waters with the boat attended.

Marina: A protected facility primarily for recreational small craft.

Marine Ways or Railways: Inclined planes at the water's edge onto which boats are hauled.

Midships: The center of the boat.

Moored: A boat secured with cables, lines or anchors.

Mooring: An anchor permanently embedded in the bottom of a harbor that is used to secure a boat.

Nautical Mile: A unit of measure equal to one minute of latitude. (6076 feet)

Nun Buoy: A red or red-striped buoy of conical shape.

Oil Pump: Supplies lubricating oil where needed within the engine.

Outboard: A boat designed for an engine to be mounted on the transom. Also a term that refers to objects away from the center line or beyond the hull sides of a boat.

Overhead: the ceiling of a cabin or compartment,

Pad Eye: A deck fitting consisting of a metal eye permanently secured to the boat.

Personal Flotation Device (PFD): For example, a life preserver or throwable device.

Pier: A structure which projects out from the shoreline.

Pile or Piling: A long column driven into the bottom to which a boat can be tied.

Pitch: The measure of the angle of a propeller blade. Refers to the theoretical distance the boat travels with each revolution of the propeller.

Pitching: The fore and aft rocking motion of a boat as the bow rises and falls.

Plenum: a chamber for directing air flow, as in engine intake air plenum

Port: The left side of the boat when facing the bow.

Porthole (port): The opening in the side of a boat to allow the admittance of light and air.

Propeller: A device having two or more blades that is attached to the engine and used for propelling a boat.

Propeller Shaft: Shaft which runs from the back of the engine gear box, aft, through the stuffing box, shaft log, struts, and onto which the propeller is attached.

Pyrotechnic Distress Signals: Distress signals that resemble the brilliant display of flares or fireworks.

Raw Water Cooled: Refers to an engine cooling system that draws sea water in through a hull fitting or engine drive unit, circulates the water in the engine, and then discharges it overboard.

Reduction Gear: Often combined with the reverse gear so that the propeller turns at a slower rate than the engine.

Reverse Gear: Changes the direction of rotation of the propeller to provide thrust in the opposite direction for stopping the boat or giving it stern-way.

Roll: A boat's sideways rotational motion in rough water.

Rope Locker: See anchor locker.

Rubrail: Railing (often rubber or hard plastic) that runs along the boat's sheer to protect the hull when coming alongside docks, piers, or other boats.

Rudder: A movable flat surface that is attached vertically at or near the stern for steering.

Sea anchor: An anchor that does not touch the bottom. Provides drag to hold the bow in the most favorable position in heavy seas.

Scupper: An opening in the hull side or transom of the boat through which water on deck or in the cockpit is drained overboard.

Seacock: Safety valves installed just inside the thru-hull fittings and ahead of the piping or hose running from the fittings.

Shaft Log: Pipe through which the propeller shaft passes.

Sheer: The uppermost edge of the hull.

Sling: A strap which will hold the boat securely while being lifted, lowered, or carried.

Slip: A boat's berth between two pilings or piers.

Sole: The deck of a cockpit or interior cabin.

Spring Line: A line that leads from the bow aft or from the stern forward to prevent the boat from moving ahead or astern.

Starboard: The right side of a boat when facing the bow.

Steerageway: Sufficient speed to keep the boat responding to the rudder or drive unit.

Stem: The vertical portion of the hull at the bow.

Stern: The rear end of a boat.

Stern line: a line that leads aft from the stern of the boat

Stow: To pack away neatly.

Stringer: Longitudinal members fastened inside the hull for additional structural strength.

Strut: Mounted to the hull which supports the propeller shaft in place.

Strut Bearing: See "cutlass bearing."

Stuffing Box: Prevents water from entering at the point where the propeller shaft passes through the shaft log.

Superstructure: Something built above the main deck level.

Swamps: When a boat fills with water from over the side.

Swimming Ladder: Much the same as the boarding ladder except that it extends down into the water.

Taffrail: Rail around the rear of the cockpit.

Thru-hull: A fitting used to pass fluids (usually water) through the hull surface, either above or below the waterline.

Topsides: The side skin of a boat between the waterline or chine and deck.

Transom: A flat stern at right angles to the keel.

Travel Lift: A machine used at boat yards to hoist boats out of and back into the water.

Trim: Refers to the boat's angle or the way it is balanced.

Trough: The area of water between the crests of waves and parallel to them.

Twin-Screw Craft: A boat with two propellers on two separate shafts.

Underway: When a boat moves through the water.

Wake: Disrupted water that a boat leaves astern as a result of its motion.

Wash: The flow of water that results from the action of the propeller or propellers.

Waterline: The plane of a boat where the surface of the water touches the hull when it is afloat on even keel.

Water pump: circulates cooling water

Watertight Bulkhead: Bulkheads secured so tightly so as not to let water pass.

Wharf: A structure generally parallel to the shore.

Windlass: A winch used to raise and lower the anchor.

Windward: Toward the direction from which the wind is coming.

Working Anchor: An anchor carried on a boat for most normal uses. Refers to the anchor used in typical anchoring situations.

Yacht Basin: A protected facility primarily for recreational small craft.

Yaw: Side-to-side movement, usually caused by rough seas.

Owner's Guide: Care & Upkeep of Fiberglass Products

As the world's premier gel coat supplier, Polynt Composites has provided this brochure as a guide to properly maintain and care for your gel coat surface.

Gel Coats provide a protective layer against weathering on a surface. Over time, exposure to sunlight, water, dust and chemicals cause wear and tear on the gel coat surface. This results in chalking, discoloration, yellowing or loss of gloss. By following simple, regular maintenance procedures, you can minimize these effects.

Basic Maintenance

When not in use, keep the gel coat surface out of the sun or covered with a canvas tarp. Do not use plastic sheeting or other non-porous materials as they trap moisture between the cover and the surface, causing damage to the gel coat.

For best results, use a cleaner recommended for use with fiberglass and follow label instructions. Alternatively, you can wash the surface with a mild detergent, such as dishwashing soap.

DO NOT use automatic dishwasher detergent, abrasive cleaners, bleach, strong acids or bases (i.e. TSP or ammonia). Only use pH neutral cleaners.

Wax at least twice a year to restore gloss and protect the finish. Only use a wax that is recommended for gel coat surfaces and follow instructions carefully. NEVER wax a gel coat surface in direct sunlight.

Corrective Procedures*

Chalking

A fine rubbing compound as well as a mild detergent will reduce the weathering and chalking accumulated on the surface. Use only a fine grit compound and follow label directions carefully. DO NOT apply rubbing compound in direct sunlight. For best results, wax after applying compound. When applying wax, remove excess compound and apply a thin layer of wax using a clean cloth. It is recommended to use a wax designed for fiberglass.

Scratches, Nicks and Stains

Most scratches and nicks can be removed by using a rubbing compound followed by waxing as described above. Deep marks or gouges should be professionally repaired.

Most stains can be removed by washing with mild detergent. For stubborn stains, use a fine abrasive household cleanser designed for fiberglass products, followed by waxing to restore its original luster.

Non-water soluble stains such as grease and oil, rubber heel marks, etc., can be removed by using a solvent such as acetone, rubbing alcohol, toluene or xylene, followed by a mild detergent. If these solvents are not effective, try a rubbing compound or fine sanding followed by a rubbing compound and then waxing.

If you have questions, consult your local dealer.



Polynt Composites USA
99 E. Cottage Ave
Carpentersville, IL 60110

800-322-8103

**Always try a test spot first*

Maintenance	Each Use	Weekly	Monthly	Semi Annually	Yearly	As Needed
Clean hull below the waterline				X		
Bottom paint					X	X
Check sacrificial anodes			X			
Replace sacrificial anodes					X	
Wash boat canvas & hardware	X		X			
Wax exterior gelcoat				X		X
Clean & protect hardware						X
Polish & protect plastic glass					X	X
Clean exterior upholstery	X					X
Clean cabin & interior upholstery						X
Flush engine with fresh water	X					
Spray metal components in bilge with a protector			X			
Clean bilge				X		X
Check bilge for leaks	X		X			
Inspect & operate thru-hull valves			X			
Inspect steering & control systems	X					
Service steering & control systems				X		
Inspect fuel system for leaks	X					
Inspect & service fuel system				X		
Inspect fuel tank vents & screens					X	
Replace fuel filters					X	
Lubricate fuel fill o-rings			X			
Inspect fire extinguisher			X			
Test bilge pump auto switches	X					
Inspect & protect electrical components, wire & battery connections				X		
Check battery electrolyte & service			X			
Test and inspect AC electrical system & shore power cord				X		
Inspect water systems for leaks				X		
Check neutral safety switch	X					
Check trim tab fluid level			X			

Date	Hours	Dealer	Service / Repairs

Date	Hours	Dealer	Service / Repairs

DEPARTMENT OF HOMELAND SECURITY U.S. Coast Guard RECREATIONAL BOATING ACCIDENT REPORT		OMB Control Number: 1625-0003 Expires: 07/31/2022	
INSTRUCTIONS: Use "Report required because" section below to determine if a report is required for your accident. If required, please have each vessel owner or operator involved in the accident submit a report to their state reporting authority. Each boat operator/owner involved in an accident should submit a separate report. For each question below, please provide answers if applicable and if known; otherwise leave blank.			
Privacy Act Notice			
Authority: 46 U.S.C. 6102 and 33 CFR 173 & 174 authorize the collection of information on boating accidents. Purpose: The Coast Guard uses this information for statistical purposes, chiefly to inform the public, to measure the Program's efforts, and to regulate issues relating to boating safety. Routine Uses: The Coast Guard shares this information within the agency, and if state and federal law permit it, to the public.			
REPORT SUBMISSION			
Report required because (select all that apply): <input type="checkbox"/> At least one person in this accident <i>died</i> . If so, how many? _____ <input type="checkbox"/> At least one injured person in this accident <i>required or was in need of treatment beyond first aid</i> . If so, how many? _____ <input type="checkbox"/> At least one person in this accident <i>disappeared</i> and has not yet been recovered. If so, how many? _____ <input type="checkbox"/> All boat and other property damage (e.g., fishing/hunting gear) caused by this accident <i>totaled (or likely totaled) \$2,000 or more</i> : Approximate value of damage to <i>your</i> boat: \$ _____ Approximate value of damage to <i>your</i> other property: \$ _____ <input type="checkbox"/> Your or another <i>boat</i> in this accident was (or likely was) a <i>total loss</i>		To be submitted within: 48 hours (if injury, disappearance or death) 10 days (if boat/property damage only) To be submitted to: (Local State Reporting Authority) Phone: You may submit any comments concerning the accuracy of the burden estimate or any suggestions for reducing the burden to: Commandant (CG-BSX-21), U.S. Coast Guard, Washington, DC 20593-0001 or Office of Management and Budget, Paperwork Reduction Project (1625-0003), Washington, DC 20503. Questions relating to the collection of this data should be sent to the Coast Guard.	
Report submitted by (select all that apply): <input type="checkbox"/> Boat Operator (required if possible) <input type="checkbox"/> Boat Owner (if operator unable, or same as operator) <input type="checkbox"/> Other (describe): _____		For State Agency Use Only	
First Name	Last Name	Phone	First Name _____ Last Name _____ Phone: _____ Primary Cause of Accident _____
ACCIDENT SUMMARY			
WHEN Date: (mm/dd/yyyy) _____ Time: _____ am <input type="checkbox"/> pm <input type="checkbox"/> (select one)		ACCIDENT DESCRIPTION: Briefly describe this accident (attach extra pages if necessary)	
WHERE Body of Water Name _____			
Location (on water) description _____ Nearest city/town _____ County: _____ State: _____		DAMAGE TO YOUR BOAT: Briefly summarize any damage to your boat	
YOUR BOAT – PEOPLE			
# people on board (including operator): _____		DAMAGE TO YOUR OTHER PROPERTY: (NOT BOAT) Briefly summarize any damage to your other property (not boat)	
# people being towed (e.g., on tubes, skis): _____			
# people wearing lifejackets (on board or towed): _____			
OTHER BOATS INVOLVED IN ACCIDENT			
# of other boats involved: _____			

For each question below, please provide answers IF APPLICABLE AND IF KNOWN, otherwise leave blank.														
YOUR BOAT														
BOAT IDENTIFICATION														
Your Boat Name:						Manufacturer:								
Model Name:						Model Year:								
Registration #:						Documentation #:								
Hull Identification # (HIN):						Rented: <input type="checkbox"/> Yes <input type="checkbox"/> No								
SIZE ESTIMATES														
Length: ft.		Depth from transom (stern) to keel (bottommost point): ft.				in.		Beam width at widest point: ft.						
HULL MATERIAL														
Type of Hull Material (select one)														
Fiberglass			Wood			Rubber/vinyl/canvas			Other (describe):					
Aluminum			Steel			Plastic								
BOAT TYPE														
Boat Type (select one)						Available Propulsion (select all that apply)								
Cabin motorboat		Inflatable boat		Personal watercraft (PWC) (e.g., Wave Runner™, Jet Ski™, Sea-Doo™)		Paddlecraft:		Propeller		Air thrust				
Open motorboat		Houseboat				Canoe		Sail		Other (describe):				
Auxiliary sail		Sail (only)		Air boat		Kayak		Manual						
Pontoon boat		Rowboat		Other (describe):				Water jet						
ENGINE														
# Engines:			Engine type and horsepower (select one)						Fuel type (select all that apply)					
Manufacturer			Outboard		Sterndrive		Inboard		Pod drive		Gas		Electric	
Total horsepower: hp			No engine		Other:				Diesel		Other:			
SAFETY MEASURES														
Organizations that have conducted a vessel safety check (VSC) on board your boat within the past year (including carriage of safety equipment, e.g., lifejackets, anchor and line, fire extinguishers):														
US Coast Guard Auxiliary: VSC Decal? <input type="checkbox"/> Yes <input type="checkbox"/> No				Federal Agency (Name):										
US Power Squadrons: VSC Decal? <input type="checkbox"/> Yes <input type="checkbox"/> No				State Agency (Name):										
				Other Agency (Name):										
# Life jackets on board:		# Fire extinguishers on board:		Type of fire extinguishers (e.g., ABC):										
		# Fire extinguishers used:												
ACCIDENT DETAILS – EXTERNAL CONDITIONS														
WEATHER														
Overall weather was (select one)				It was (select one)		Visibility was (select one)				Wind was (select one)				
Clear		Raining		Day		Good		0 mph (none)						
Cloudy		Snowing		Night		Fair		Over 0, up to 12 mph (light)						
Foggy		Hazy				Poor		Over 12, up to 25 mph (moderate)						
Other (describe):				Approximate air temperature:		°F		Over 25, up to 55 mph (strong)						
								Over 55 mph (stormy)						
WATER														
Overall water conditions (select one):						Other water conditions:								
Up to 6 in. waves (calm)						Approximate water temperature:				°F				
Over 6 in., up to 2 ft. waves (choppy)						Strong current?				Yes <input type="checkbox"/> No <input type="checkbox"/>				
Over 2 ft., up to 6 ft. waves (rough)						Hazardous waters? (e.g., rapid tidal flow, currents)				Yes <input type="checkbox"/> No <input type="checkbox"/>				
Over 6 ft. waves (very rough)						Congested waters?				Yes <input type="checkbox"/> No <input type="checkbox"/>				

For each question below, please provide answers IF APPLICABLE AND IF KNOWN, otherwise leave blank.			
ACCIDENT DETAILS – ACTIVITIES AND OPERATIONS ON YOUR BOAT			
OPERATOR/PASSENGER ACTIVITIES			
Operator/passenger activities on <i>your</i> boat at time of accident:			
Activities were (select one)		Operator/Passenger activities (select all that apply)	
<input type="checkbox"/> Recreational	<input type="checkbox"/> Fishing	<input type="checkbox"/> Tubing	<input type="checkbox"/> Starting engine
<input type="checkbox"/> Commercial	<input type="checkbox"/> Hunting	<input type="checkbox"/> Water Skiing	<input type="checkbox"/> Making repairs
	<input type="checkbox"/> White water activity (e.g., rafting)	<input type="checkbox"/> Relaxing	<input type="checkbox"/> Other (list):
BOAT OPERATIONS			
Your boat operations at time of accident (select all that apply)			
<input type="checkbox"/> Cruising (underway under power)	<input type="checkbox"/> Drifting	<input type="checkbox"/> Racing	<input type="checkbox"/> Towing another vessel
<input type="checkbox"/> Changing direction	<input type="checkbox"/> At anchor	<input type="checkbox"/> Rowing/paddling	<input type="checkbox"/> Launching
<input type="checkbox"/> Changing speed	<input type="checkbox"/> Being towed	<input type="checkbox"/> Docking/undocking	<input type="checkbox"/> Tied to dock/mooring
<input type="checkbox"/> Sailing	<input type="checkbox"/> Other (list):		
ACCIDENT DETAILS – CONTRIBUTING FACTORS ON YOUR BOAT			
CONTRIBUTING FACTORS			
Indicate factors on <i>your</i> boat which may have contributed to this accident (select all that apply)			
<input type="checkbox"/> Alcohol use	<input type="checkbox"/> Improper lookout	<input type="checkbox"/> Dam/lock	<input type="checkbox"/> Starting in gear
<input type="checkbox"/> Drug use	<input type="checkbox"/> Operator inattention	<input type="checkbox"/> Force of wake/wave	<input type="checkbox"/> Sharp turn
<input type="checkbox"/> Excessive speed	<input type="checkbox"/> Operator inexperience	<input type="checkbox"/> Hazardous waters	<input type="checkbox"/> Restricted vision (e.g., fog)
<input type="checkbox"/> Improper anchoring	<input type="checkbox"/> Language barrier	<input type="checkbox"/> Heavy weather	<input type="checkbox"/> Mission/inadequate aids to navigation (e.g., buoy, daymarker)
<input type="checkbox"/> Improper loading	<input type="checkbox"/> Navigation rules violation	<input type="checkbox"/> Ignition of fuel or vapor	<input type="checkbox"/> Inadequate on-board navigation lights
<input type="checkbox"/> Overloading	<input type="checkbox"/> Failure to vent	<input type="checkbox"/> Hull failure	<input type="checkbox"/> People on gunwale, bow or transom
<input type="checkbox"/> Other (describe):			
ACCIDENT DETAILS – YOUR BOAT			
MACHINERY/EQUIPMENT FAILURE			
Failure of the following machinery/equipment on <i>your</i> boat contributed to this accident (select all that apply)			
<input type="checkbox"/> Engine	<input type="checkbox"/> Onboard lights	<input type="checkbox"/> Shift	<input type="checkbox"/> Sound equipment (e.g., horn, whistle)
<input type="checkbox"/> Electrical system	<input type="checkbox"/> Seats	<input type="checkbox"/> Radio	<input type="checkbox"/> Auxiliary equipment
<input type="checkbox"/> Fuel system	<input type="checkbox"/> Steering	<input type="checkbox"/> Fire extinguisher	<input type="checkbox"/> Other (list):
<input type="checkbox"/> Sail/mast	<input type="checkbox"/> Throttle	<input type="checkbox"/> Ventilation	
<input type="checkbox"/> Onboard navigation aids (e.g., GPS)			
ACCIDENT DETAILS – EVENTS ON YOUR BOAT			
ACCIDENT EVENTS			
Types of events occurring to/on <i>your</i> boat during accident (select all that apply)			
<input type="checkbox"/> Collision with recreational boat	<input type="checkbox"/> Flooding/swamping	<input type="checkbox"/> Person fell overboard	
<input type="checkbox"/> Collision with commercial boat (e.g., tug, barge)	<input type="checkbox"/> Fire/explosion – fuel	<input type="checkbox"/> Person fell on/within boat	
<input type="checkbox"/> Collision with fixed object (e.g., dock, bridge)	<input type="checkbox"/> Fire/explosion – non-fuel	<input type="checkbox"/> Sudden medical condition	
<input type="checkbox"/> Collision with submerged object (e.g., stump, cable)	<input type="checkbox"/> Carbon monoxide exposure	<input type="checkbox"/> Person struck by boat	
<input type="checkbox"/> Collision with floating object (e.g., log, buoy)	<input type="checkbox"/> Mishap of skier, tuber, wake boarder, etc.	<input type="checkbox"/> Person struck by propeller or propulsion unit	
<input type="checkbox"/> Capsizing	<input type="checkbox"/> Person left boat voluntarily	<input type="checkbox"/> Person electrocuted	
<input type="checkbox"/> Grounding	<input type="checkbox"/> Person ejected from boat (caused by collision or maneuver)		
<input type="checkbox"/> Sinking	<input type="checkbox"/> Other (describe):		

For each question below, please provide answers IF APPLICABLE AND IF KNOWN, otherwise leave blank.									
ACCIDENT DETAILS – YOUR BOAT- INJURED PEOPLE RECEIVING OR IN NEED OF TREATMENT BEYOND FIRST AID									
<i>Report only injured people on, struck by, or being towed by your boat, receiving or in need of treatment beyond first aid. Do not report injured people on, struck by, or being towed by another boat or no boat (e.g., swimmers, people on a dock). If more than one injured person to report, attach additional copies of this page. If none, SKIP INJURED PEOPLE section.</i>									
INJURED PERSON									
First Name				MI		Last Name			
Street									
City				State			Zip		
Phone				Date of Birth (mm/dd/yyyy)			Age		
INJURY DETAILS									
Injury caused when person (select all that apply)					Nature of most serious injury (select one)				
Struck the (e.g., boat, water):					Scrape/bruise		Dislocation		
Was struck by a (e.g., boat, propeller):					Cut		Internal organ injury		
Was exposed to carbon monoxide poisoning					Sprain/strain		Amputation		
Received an electric shock					Concussion/brain injury		Burn		
Other (describe):					Spinal cord injury		Other (describe):		
Person was wearing lifejacket?			Yes	No	Broken/fractured bone				
Person received treatment beyond first aid?			Yes	No	Body part of most serious injury (e.g., head, trunk, leg):				
Person was admitted to a hospital?			Yes	No					
ACCIDENT DETAILS – YOUR BOAT – DEATHS/DISAPPEARANCES									
<i>Only report deaths/disappearances of people on, struck by, or being towed by your boat. If more than one death/disappearance to report, attach additional copies of this page. If none, SKIP DEATHS/DISAPPEARANCES section.</i>									
PERSON WHO DIED/DISAPPEARED									
First Name				MI		Last Name			
Street									
City				State			Zip		
Phone				Date of Birth (mm/dd/yyyy)			Age		
DETAILS OF DEATH/DISAPPEARANCE									
Injury caused when person (select all that apply)					Nature of death/disappearance (select one)				
Struck the (e.g., boat, water):					Death – by drowning				
Was struck by a (e.g., boat, propeller):					Death – other likely cause (describe)				
Was exposed to carbon monoxide poisoning									
Received an electric shock					Disappeared and not yet recovered				
Other (describe):					Person was wearing lifejacket?		Yes	No	

For each question below, please provide answers IF APPLICABLE AND IF KNOWN, otherwise leave blank.							
ACCIDENT DETAILS – YOUR BOAT OPERATOR							
OPERATOR INSTRUCTION				OPERATOR SAFETY MEASURES			
Boating safety instruction completed <i>(select all that apply)</i>				On board, prior to accident, was operator wearing:			
None				A lifejacket?		Yes	No
State course				An engine cut-off switch <i>(Lanyard or wireless device) if equipped?</i>		Yes	No
USCG Auxiliary course				On board, prior to accident, was operator using:			
US Power Squadrons course				Alcohol?		Yes	No
Internet <i>(name of sponsoring organization)</i>				Drugs?		Yes	No
Other <i>(describe)</i>				Operator arrested for Boating Under the Influence?		Yes	No
				Weather reports consulted prior to accident?		Yes	No
OPERATOR EXPERIENCE							
Experience operating this type of boat <i>(select one)</i>							
0 to 10 hours		Over 10, up to 100 hours		Over 100, up to 500 hours		Over 500 hours	
ACCIDENT DETAILS – OTHER KEY PEOPLE							
Only report other key people not already documented as injured, died, disappeared or operator/owner of your boat. If more than two other key people to report, attach additional copies of this page.							
NAME/ADDRESS							
This other key person was a(n) <i>(select all that apply)</i>							
<input type="checkbox"/> Other boat operator <input type="checkbox"/> Other boat owner <input type="checkbox"/> Owner of other damaged property <input type="checkbox"/> Passenger on your boat <input type="checkbox"/> Witness							
First Name			MI	Last Name			
Street							
City			State	Zip	Phone		
Other boat name <i>(if any)</i>				Other boat registration # <i>(if any)</i>			
NAME/ADDRESS							
This other key person was a(n) <i>(select all that apply)</i>							
<input type="checkbox"/> Other boat operator <input type="checkbox"/> Other boat owner <input type="checkbox"/> Owner of other damaged property <input type="checkbox"/> Passenger on your boat <input type="checkbox"/> Witness							
First Name			MI	Last Name			
Street							
City			State	Zip	Phone		
Other boat name <i>(if any)</i>				Other boat registration # <i>(if any)</i>			

For each question below, please provide answers IF APPLICABLE AND IF KNOWN, otherwise leave blank.					
YOUR BOAT OPERATOR					
NAME/ADDRESS					
First Name	MI	Last Name			
Street					
City	State	Zip			
AGE/GENDER/PHONE					
Date of Birth (mm/dd/yyyy)	Age	Gender	Male	Female	Phone
YOUR BOAT OWNER					
If same as <i>your boat operator</i> SKIP rest of YOUR BOAT OWNER section.					
NAME/ADDRESS/PHONE					
First Name	MI	Last Name			
Street					
City	State	Zip	Phone		
PERSON SUBMITTING THIS REPORT					
If same as <i>your boat operator</i> OR <i>owner</i> , SKIP rest of PERSON SUBMITTING THIS REPORT section.					
NAME/ADDRESS/PHONE/ROLE					
First Name	MI	Last Name			
Street					
City	State	Zip	Phone		
I was a(n) (select one)					
<input type="checkbox"/>	Other person on board <i>this</i> boat				
<input type="checkbox"/>	Accident witness <i>not</i> on board <i>this</i> boat				
<input type="checkbox"/>	Other (<i>describe</i>):				
SIGNATURE OF PERSON SUBMITTING THIS REPORT					
Your signature				Date (mm/dd/yyyy)	
<p>An Agency may not conduct or sponsor and a person is not required to respond to an information collection, unless it displays a currently valid OMB Control Number.</p> <p>The Coast Guard estimates that the average burden for this report form is 30 minutes. You may submit any comments concerning the accuracy of this burden estimate or any suggestions for reducing the burden to: Commandant (CG-BSX-21), U.S. Coast Guard, Washington, DC 20593-0001 or Office of Management and Budget, Paperwork Reduction Project (1625-0003), Washington, DC 20503.</p>					



www.cgaux.org

FLOAT PLAN

INSTRUCTIONS: Complete this plan before you go boating and leave it with a reliable person who can be depended upon to notify the Coast Guard, or other rescue agency, should you not return or check-in as planned. If you have a change of plans, or will be delayed, notify the person holding your Float Plan. Finally, close your plan by notifying the holder you have arrived home safely and if the holder has reported you overdue, notify all applicable rescue authorities of your safe return.



www.uscgboating.org

Do NOT file this plan with the Coast Guard

VESSEL

IDENTIFICATION:

Name & Hailing Port _____
 Document / Registration No. _____ HIN _____
 Year, Make & Model _____
 Length _____ Type _____ Draft _____ Hull Mat. _____
 Hull & Trim Colors _____
 Prominent Features _____

COMMUNICATION:

Radio Call Sign / Number _____
 DSC MMSI No. _____
 Radio-1: Type _____ Ch. / Freq. Monitored _____
 Radio-2: Type _____ Ch. / Freq. Monitored _____
 Cell / Satellite _____
 Email _____

PROPULSION:

Primary-- Type _____ Eng. _____ Fuel Capacity _____
 Auxiliary--Type _____ Eng. _____ Fuel Capacity _____

NAVIGATION: (Check all onboard)

Compass Radar GPS / DGPS Depth Sounder
 Charts Maps _____

SAFETY & SURVIVAL

VISUAL DISTRESS SIGNALS:

Electric Distress Light (night only)
 Flag (day only)
 Flare, Aerial (day & night)
 Flare, Handheld (day & night)
 Signal Mirror (day only)
 Smoke (day only)

AUDIBLE DISTRESS SIGNALS:

Bell
 Horn
 Whistle

EPIRB:

UIN* _____

ADDITIONAL GEAR:

Anchor - Line length _____ Food for _____ days / person
 Dewatering device Water for _____ days / person
 Exposure suits _____
 Fire Extinguisher _____
 Flashlight / Searchlight _____
 Raft / Dinghy _____

PERSONS ONBOARD

OPERATOR:

Name _____
 Address _____
 City _____ State _____ Zip Code _____
 Age _____ Gender _____ PFD PLB UIN* _____
 Note _____
 Float Plan Note _____

Has experience with: this vessel; the boating area(s).
 Home Phone _____
 Vehicle (Year, Make & Model) _____
 Vehicle License No. _____ Trailer
 Vehicle parked at _____

PASSENGERS / CREW: (Identify all on board)

Name	Home Phone	Age	Gender	PFD	Note
1. _____	_____	_____	_____	<input type="checkbox"/>	_____
2. _____	_____	_____	_____	<input type="checkbox"/>	_____
3. _____	_____	_____	_____	<input type="checkbox"/>	_____
4. _____	_____	_____	_____	<input type="checkbox"/>	_____
5. _____	_____	_____	_____	<input type="checkbox"/>	_____
6. _____	_____	_____	_____	<input type="checkbox"/>	_____
7. _____	_____	_____	_____	<input type="checkbox"/>	_____
8. _____	_____	_____	_____	<input type="checkbox"/>	_____
9. _____	_____	_____	_____	<input type="checkbox"/>	_____
10. _____	_____	_____	_____	<input type="checkbox"/>	_____
11. _____	_____	_____	_____	<input type="checkbox"/>	_____
12. _____	_____	_____	_____	<input type="checkbox"/>	_____

Passenger PLB UIN*
 (Not listed in a specific order)

If you have a genuine concern for the safety or welfare of the persons onboard this vessel that have not returned or checked-in, in a reasonable amount of time, then follow the step-by-step instructions on the Boating Emergency Guide™ located on the last page of this Float Plan.

(*) EPIRB and PLB registration required by Federal regulations. www.beaconregistration.noaa.gov



www.cgaux.org

FLOAT PLAN continued

INSTRUCTIONS: Complete this plan before you go boating and leave it with a reliable person who can be depended upon to notify the Coast Guard, or other rescue agency, should you not return or check-in as planned. If you have a change of plans, or will be delayed, notify the person holding your Float Plan. Finally, close your plan by notifying the holder you have arrived home safely and if the holder has reported you overdue, notify all applicable rescue authorities of your safe return.

Do NOT file this plan with the U.S. Coast Guard



www.uscgboating.org

CONTACTS

Contact 1 _____ Phone Number _____

Contact 2 _____ Phone Number _____

Rescue Authority _____ Phone Number _____

ITINERARY

		DATE	TIME	LOCATION / WAYPOINT	MODE OF TRAVEL	REASON FOR STOP	CHECK-IN TIME
1	Depart						
	Arrive						
2	Depart						
	Arrive						
3	Depart						
	Arrive						
4	Depart						
	Arrive						
5	Depart						
	Arrive						
6	Depart						
	Arrive						
7	Depart						
	Arrive						
8	Depart						
	Arrive						
9	Depart						
	Arrive						
10	Depart						
	Arrive						
11	Depart						
	Arrive						
12	Depart						
	Arrive						
13	Depart						
	Arrive						
14	Depart						
	Arrive						
15	Depart						
	Arrive						
16	Depart						
	Arrive						
17	Depart						
	Arrive						
18	Depart						
	Arrive						
19	Depart						
	Arrive						
20	Depart						
	Arrive						
21	Arrive						

If you have a genuine concern for the safety or welfare of the persons onboard this vessel that have not returned or checked-in, in a reasonable amount of time, then follow the step-by-step instructions on the Boating Emergency Guide™ located on the last page of this Float Plan.

USCG Float Plan - BOATING EMERGENCY GUIDE™

BEFORE YOU BEGIN – This guide is designed to work either with or without a Float Plan. You will need the following items: 1) the Float Plan, if one was given to you; 2) a pen or pencil; 3) a clean sheet of paper or writing tablet; and 4) your local telephone directory.

Step 1: Do you have a genuine concern for the safety or welfare of any persons who have not returned or checked-in, in a reasonable amount of time?

If **yes**, then continue with **Step 2**. Otherwise **STOP** – no further action is required at this time.

Step 2: Were you given a prepared Float Plan by anyone on board the vessel?

If **yes**, then continue with **Step 3**. Otherwise, go to **Step 5**.

Step 3: Locate the Contacts at the top of page 2 on the Float Plan. Call Contact number 1...

IF CONTACT #1	THEN						
Answers phone	Take notes during your conversation. <ol style="list-style-type: none"> Let the person know you are responding to a late return or check-in by the individuals designated on the Float Plan. Determine if the person you are talking to, or anyone else at that location, has recently had contact with anyone on the vessel, and when and where that contact occurred. Are you still concerned about the safety or welfare of any persons on board the vessel? <table border="1"> <thead> <tr> <th>IF</th> <th>THEN</th> </tr> </thead> <tbody> <tr> <td>Yes</td> <td>Continue with Step 4.</td> </tr> <tr> <td>No</td> <td>STOP. No further action is required.</td> </tr> </tbody> </table>	IF	THEN	Yes	Continue with Step 4 .	No	STOP . No further action is required.
IF	THEN						
Yes	Continue with Step 4 .						
No	STOP . No further action is required.						
Does not answer phone	Continue with Step 4 .						

Step 4: Call Contact number 2...

IF CONTACT #2	THEN						
Answers phone	Take notes during your conversation. <ol style="list-style-type: none"> Let the person know you are responding to a late return or check-in by the individuals designated on the Float Plan. Determine if the person you are talking to, or anyone else at that location, has recently had contact with anyone on the vessel, and when and where that contact occurred. Are you still concerned about the safety or welfare of any persons on board the vessel? <table border="1"> <thead> <tr> <th>IF</th> <th>THEN</th> </tr> </thead> <tbody> <tr> <td>Yes</td> <td>Continue with Step 6.</td> </tr> <tr> <td>No</td> <td>STOP. No further action is required.</td> </tr> </tbody> </table>	IF	THEN	Yes	Continue with Step 6 .	No	STOP . No further action is required.
IF	THEN						
Yes	Continue with Step 6 .						
No	STOP . No further action is required.						
Does not answer phone	Continue with Step 6 .						

Step 5: Using the checklist below, jot down only what you know about each item:

DO NOT SPECULATE. Incorrect information may mislead Search and Rescue personnel; add to the overall search and rescue time; and adversely affect the outcome.

- Period of time the vessel has been overdue.
- Purpose of the trip or voyage.
- Description of vessel. (Type, size, color, features, etc.)
- Vessel's departure point and destination.
- Places the vessel planned to stop during transit.
- Navigation equipment aboard. (Examples: GPS, radar, compass, sounder, etc.)
- Number of persons aboard. Relevant characteristics such as dependability, reliability, etc.
- Was the vessel initially docked or moored or did a vehicle tow it to a launch point?
- License plate number and description of the tow vehicle and/or the passenger's transport vehicle.
- Communications equipment aboard, including type of radio and frequencies monitored, cellular or satellite telephone numbers of individuals, etc.
- Additional points of contact along the vessel's planned route.
- Operator and/or a passenger/crew member absolutely had to be back at the scheduled return time.
- Call your local Rescue Authority that responds to marine emergencies (Police, Sheriff, Constable, First responder, etc.).

Go to **Step 6-2**.

Step 6:

- Call the Rescue Authority contact at the top of page 2 on the Float Plan.
- Tell the dispatcher you are responding to a late return or check-in by the persons on board the vessel.
- The dispatcher will instruct you from there.

Note: The dispatcher will provide you with the necessary contact or agency connection to get a search and rescue mission started. This puts you in direct contact with the agency conducting the actual search and rescue, eliminating unnecessary middlemen.
The dispatcher will tell you if he/she desires a follow-up call on the outcome of the rescue.

4. Continue with **Step 7**.

Step 7: Be patient... you've done everything you can possibly do for now. It is important to keep the telephone available so emergency personnel can contact you with additional information and/or questions concerning the search and rescue effort.

STOP – End of Guide

Provided as a courtesy by:
S2 Yachts, Inc.
Holland, MI
(616) 392-7163
Get a Vessel Safety Check before you go boating.



The USCG Float Plan is the official Float Plan of the U.S. Coast Guard and U.S. Coast Guard Auxiliary. For more information visit:

www.floatplancentral.org

Problem	Cause and Solution
Control Systems	
<p>Hydraulic steering is slow to respond and erratic.</p>	<ul style="list-style-type: none"> • Steering system is low on fluid. Fill and bleed system. • Steering system has air in it. Fill and bleed system. • A component in the steering system is binding. Check and adjust or repair binding component. • Engine steering cylinder is binding. Grease spindle.
<p>The boat wanders and will not hold a course at cruise speeds.</p>	<ul style="list-style-type: none"> • There could be air in the steering system. Fill & bleed the system. • The engine steering tab is corroded or out of adjustment. Replace or adjust steering tab. • Engine steering cylinder is binding. Grease spindle.
<p>The engine will not start with the shift control lever in neutral.</p>	<ul style="list-style-type: none"> • The control cable is out of adjustment & not activating the neutral safety cut out switch. • The shift control lever is not in the neutral detent. Try moving the shift lever slightly. • There is a loose wire on the neutral safety switch on the transmission. Inspect wires and repair loose connections. • The starter or ignition switch is bad.
Performance Problems	
<p>Boat is sluggish and has lost speed and RPM.</p>	<ul style="list-style-type: none"> • The boat may be need to have marine growth cleaned from hull and running gear. • Propeller may be damaged & need repair. • Weeds or line around the propeller. Clean propeller. • Boat is overloaded. Reduce load. • Check for excessive water in the bilge. Pump out bilge & find & correct the problem. • The throttle adjustments has changed and the engine is not getting full throttle. Adjust the throttle cable.

Problem	Cause and Solution
<p>The boat vibrates at cruising speeds.</p>	<ul style="list-style-type: none"> • Propeller may be damaged and need repair. • The propeller or propeller shaft is bent. Repair or replace damaged components. • The running gear is fouled by marine growth or rope. Clean running gear. • The engine is not trimmed properly. Trim the engine.
<p>Engine Problems</p>	
<p>The engine is running too hot.</p>	<ul style="list-style-type: none"> • The engine raw water pick-up strainer up is clogged with marine growth. Clean pick-up. • The engine raw water pump impeller is worn or damaged. Repair the pump. • The engine thermostat is faulty and needs to be replaced.
<p>The engine alternator is not charging properly.</p>	<ul style="list-style-type: none"> • The battery cable is loose or corroded. Clean and tighten battery cables. • The alternator is not charging and must be replaced. • The engine battery isolator in the charging system is not working properly. Replace the isolator. • The battery is defective. Replace the battery. • The alternator breaker may be in the OFF position.
<p>The engine suddenly will not operate over 2000 RPM.</p>	<ul style="list-style-type: none"> • The engine emergency system has been activated. The onboard computer has sensed a problem and has limited the RPM to protect the engine. Find & correct the problem. • The tachometer is bad and needs to be replaced.

Problem	Cause and Solution
<p>The engine is loosing RPM. The boat is not overloaded and the hull bottom and running gear are clean and in good condition.</p>	<ul style="list-style-type: none"> • The engine may be having a problem with a sticky anti-siphon valve, located in the fuel line near the fuel tank, that is restricting the fuel flow. Remove & clean or replace the anti-siphon valve. • The remote gasoline fuel filter could be dirty. Inspect and replace the fuel filter. • The primary fuel filter on the engine may be dirty. Inspect and replace the fuel filter. • The electronic engine control system on the engine is malfunctioning. Repair the engine control system. • The fuel injection system on the engine is malfunctioning. Repair the fuel injection system.
<p>Accessory Problems</p>	
<p>The livewell pump runs, but does not pump water.</p>	<ul style="list-style-type: none"> • The strainer on the intake scoop is clogged preventing the water from getting to the pump. Put the boat in reverse to clean the strainer. • There is an air lock in the system. Run the boat above 15 m.p.h. and the pick-up scoop will force the air lock past the pump and prime the system. • The thru-hull valve is not open. Open valve. • The valve in the livewell is not open. Open the valve in the livewell.
<p>The automatic float switch on the bilge pump raises but does not activate the pump.</p>	<ul style="list-style-type: none"> • The in-line fuse near the battery switch has blown. Replace the fuse. • The pump impeller is jammed by debris. Clean pump impeller housing. • The pump is defective. Replace pump.

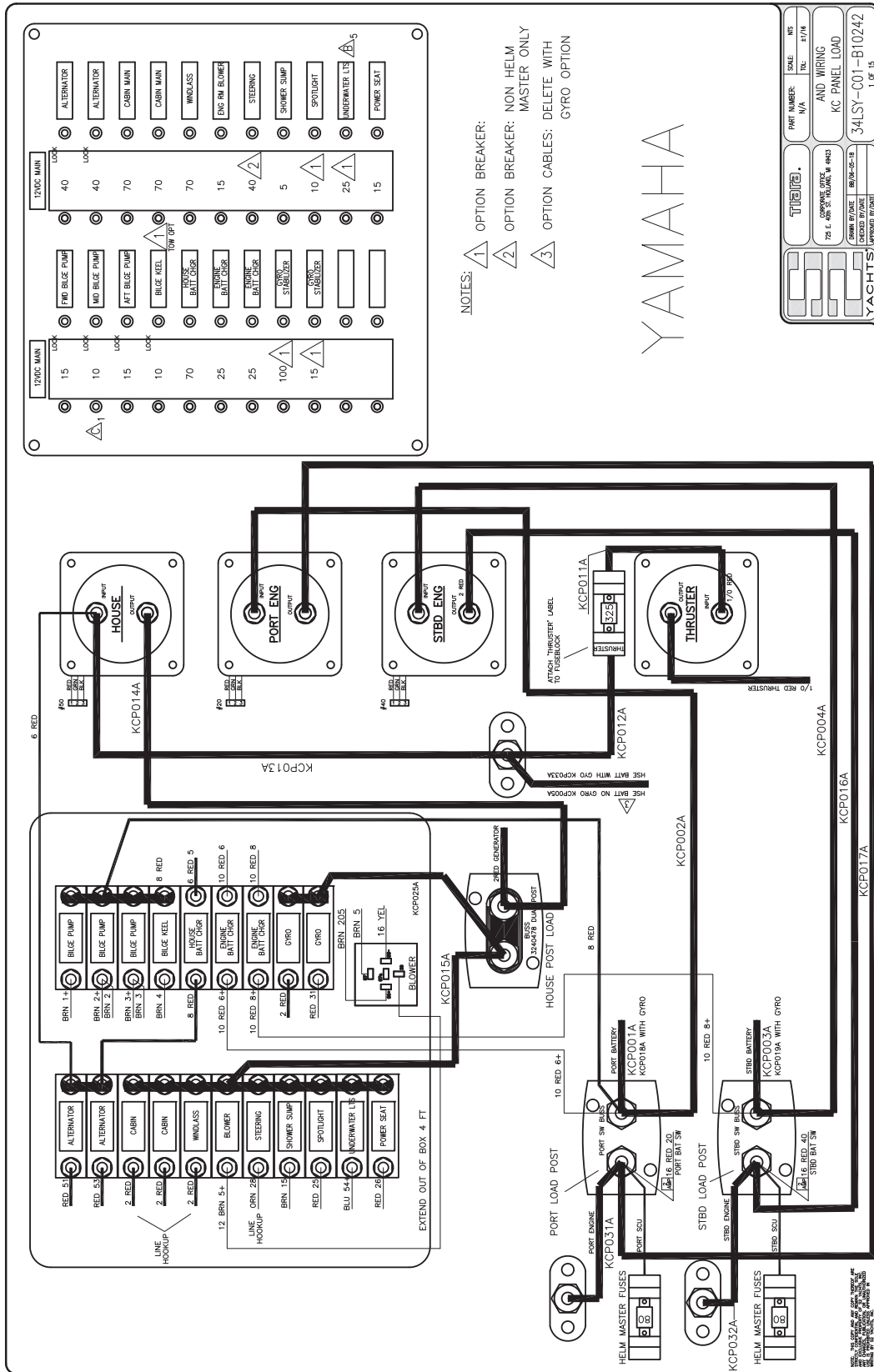

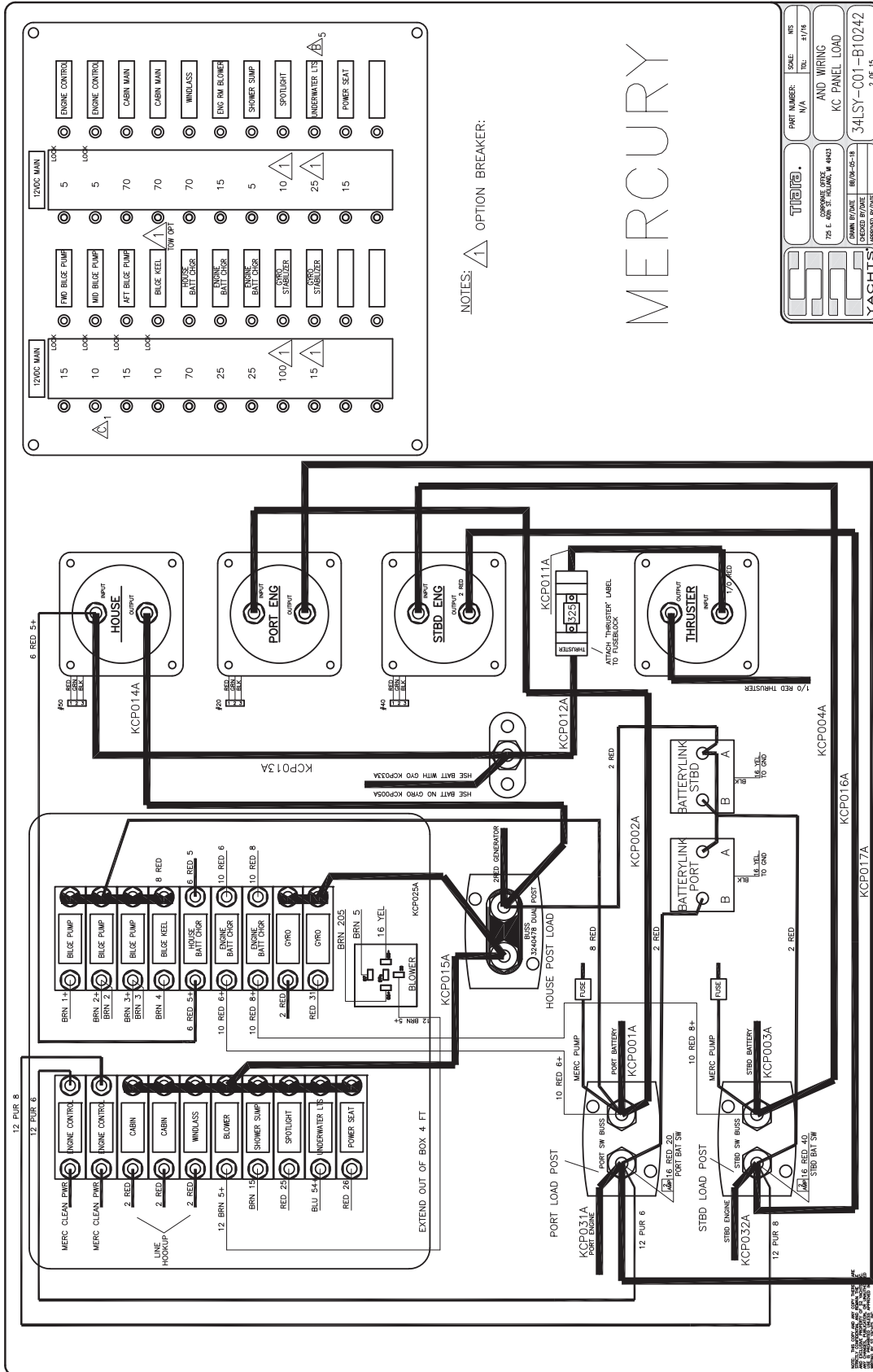

TUBO.	PART NUMBER:	SCALE:	NWS
	1/A		1/78
AND WIRING		KC PANEL LOAD	
775 E. 40th ST. TOLSON, W. 4443		34LSY-C01-B10242	
DATE: 05-18	REV: 05-18	2 OF 15	
YACHTS			

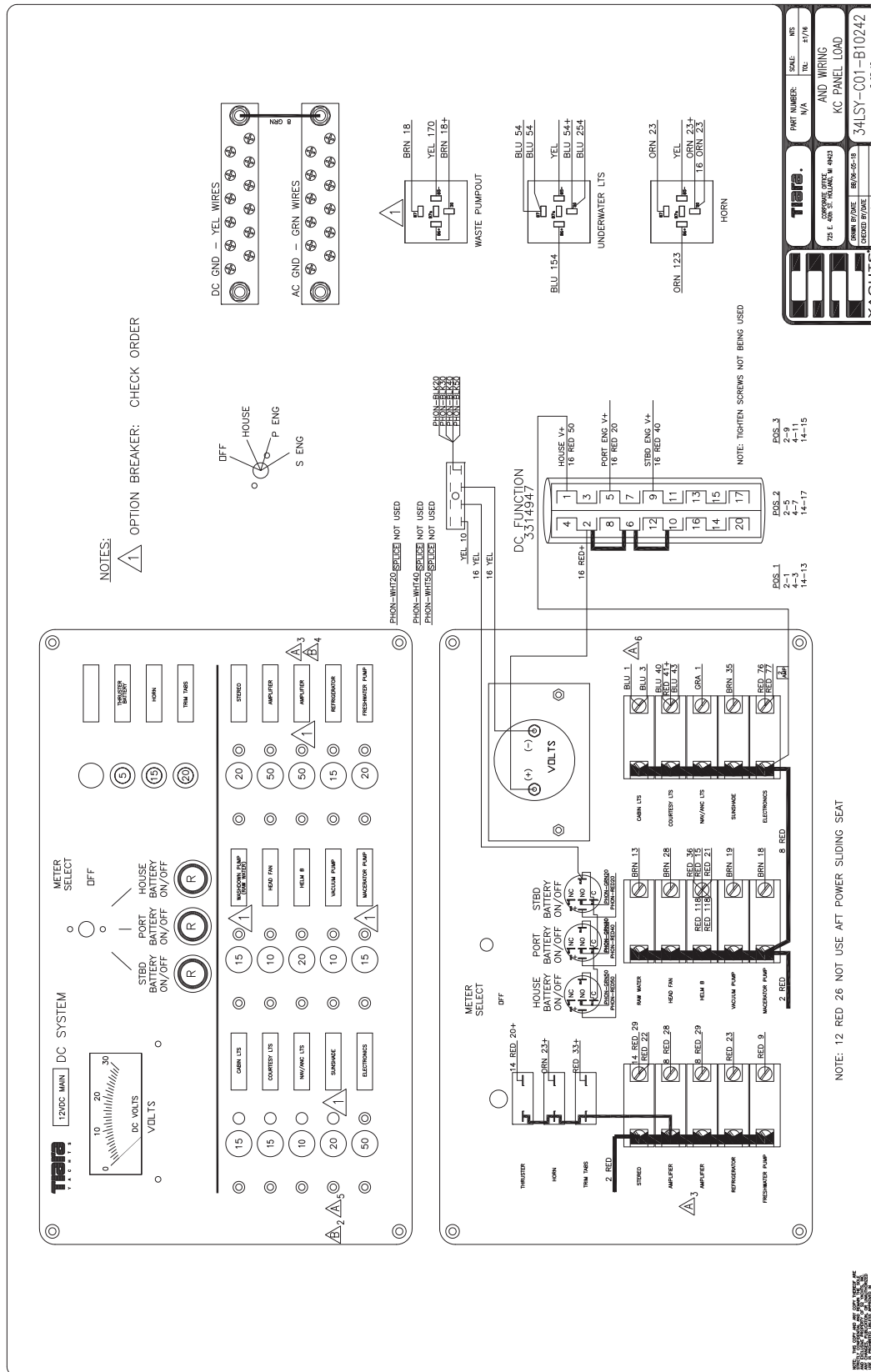

NOTES:

- 1 CABIN OR HELM AIR OPT BREAKER: CHECK ORDER
- 2 COCKPIT GRILL: CHECK ORDER
- 3 WATER HEATER IS STANDARD WITH GENERATOR OPT
- 4 GENERATOR OPT BREAKER AND SLIDE LOCKOUT: CHECK ORDER

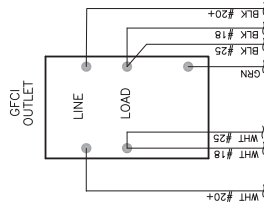
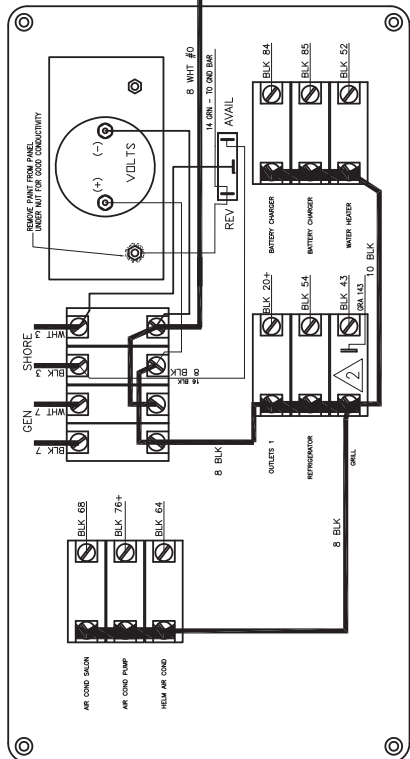
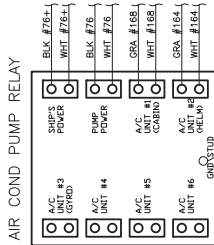
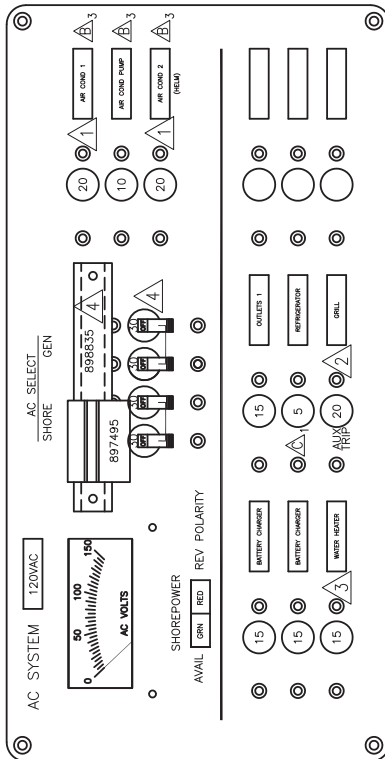

TUBO.	
PART NUMBER: 1/A	SCALE: NTS 1/4"
DATE: 1/7/18	
AND WIRING KC PANEL LOAD	
75 E. 400 ST. VILLAGE # 9423	
DATE: 1/7/18	REV: 05-18
APPROVED BY: [Signature]	34LSY-C01-B10242
4 OF 15	
YACHTS	

TUBO. 75 E. 400 ST. VILLAGE # 9423

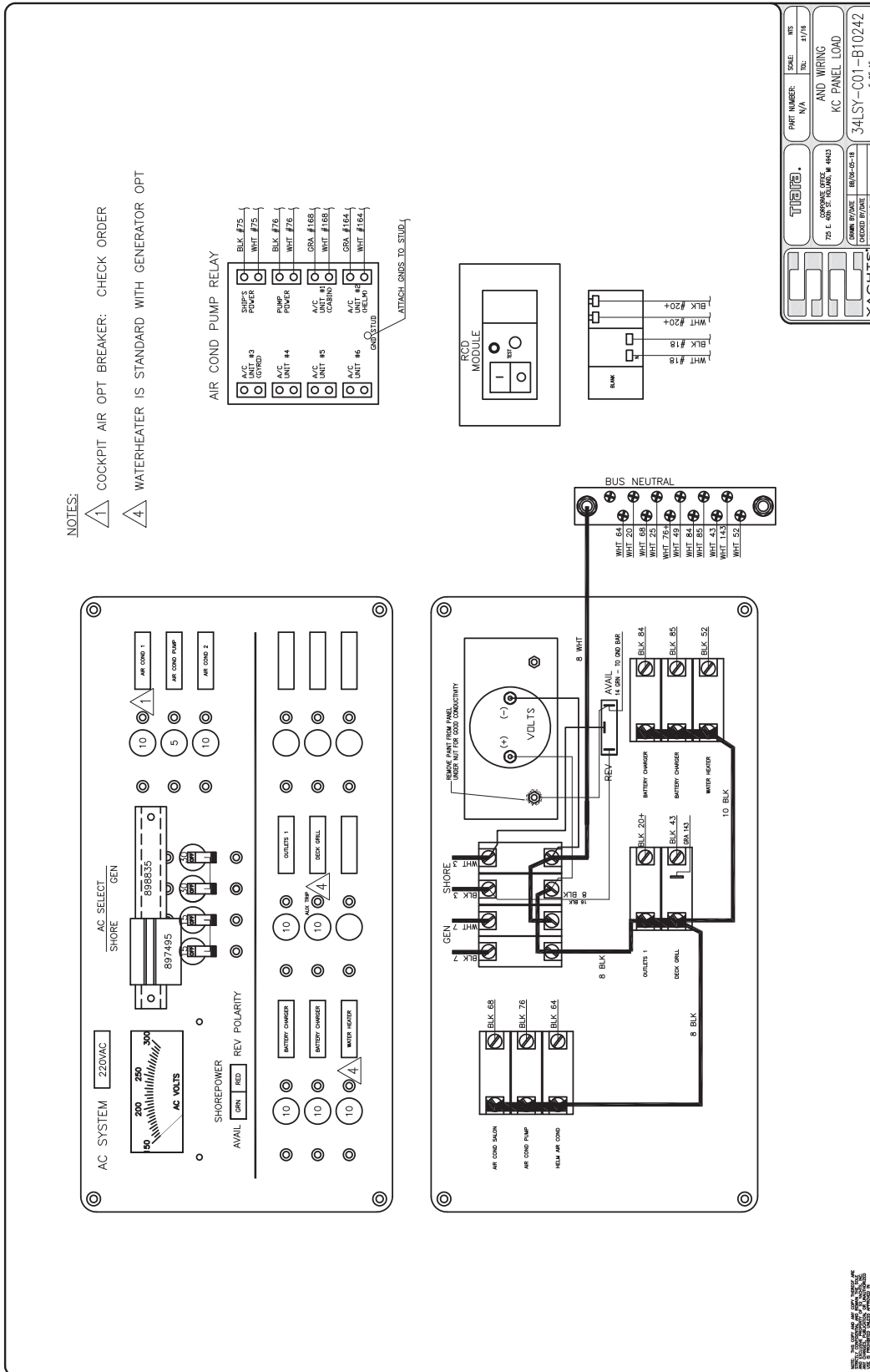

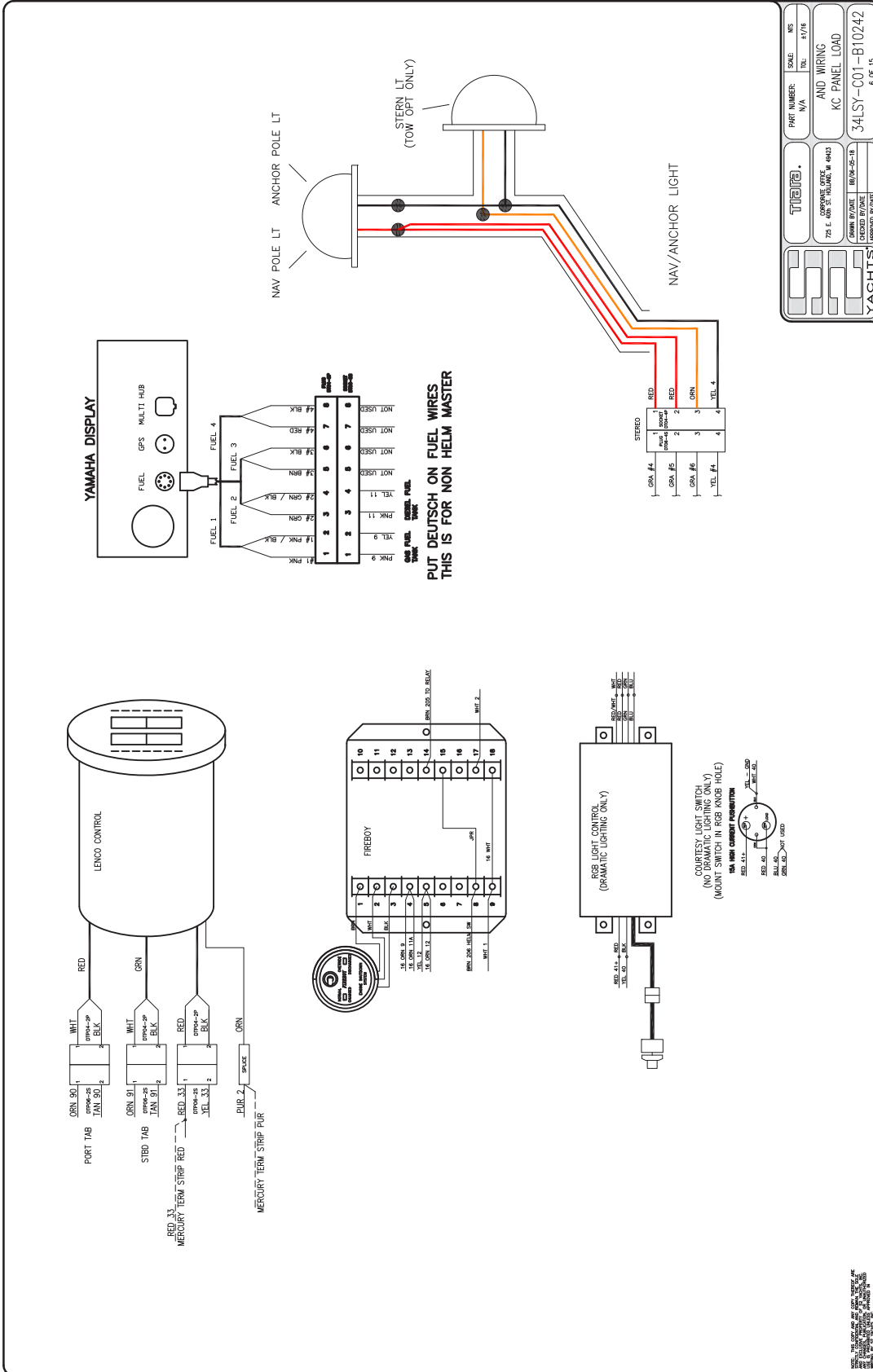

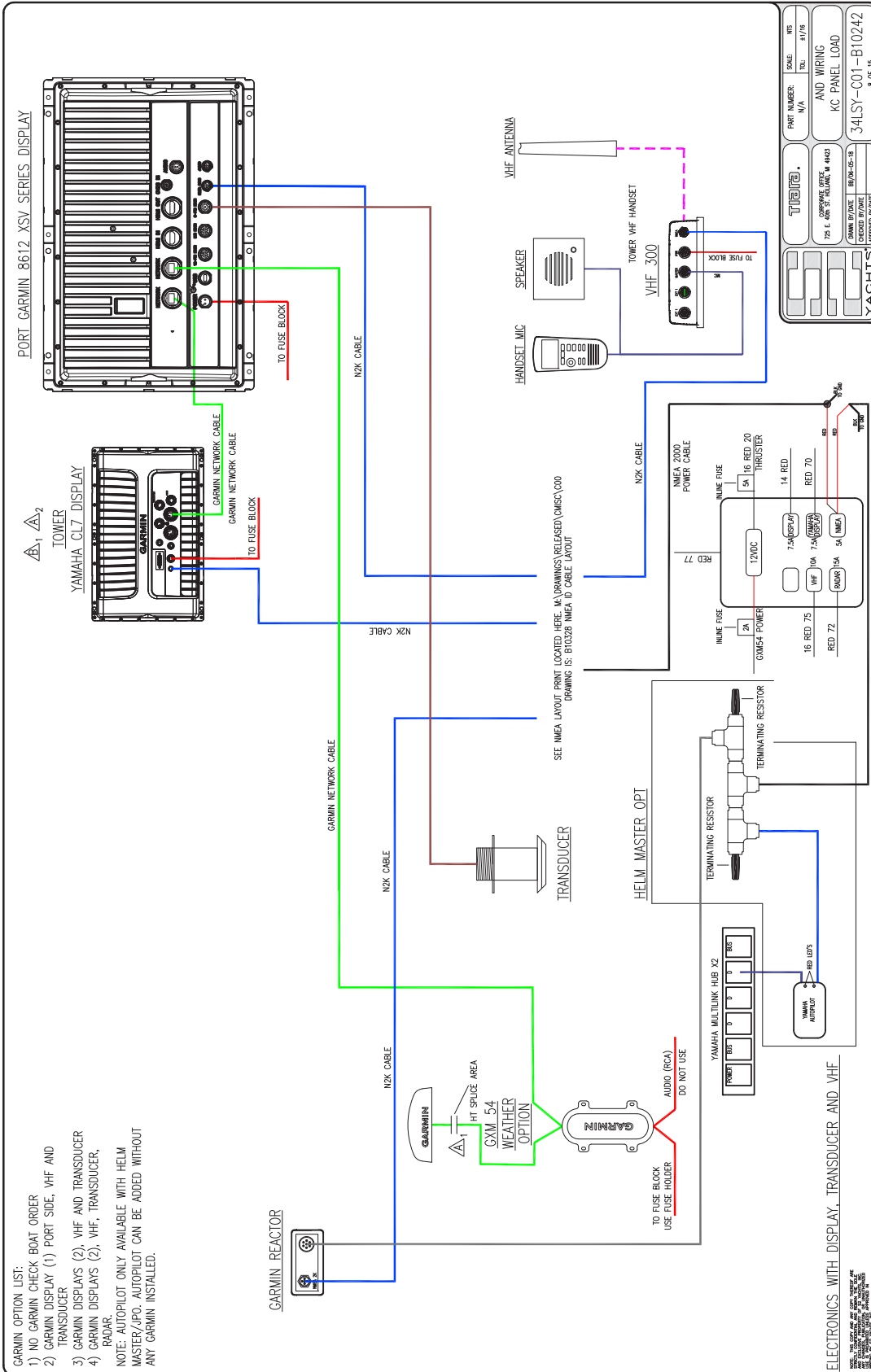

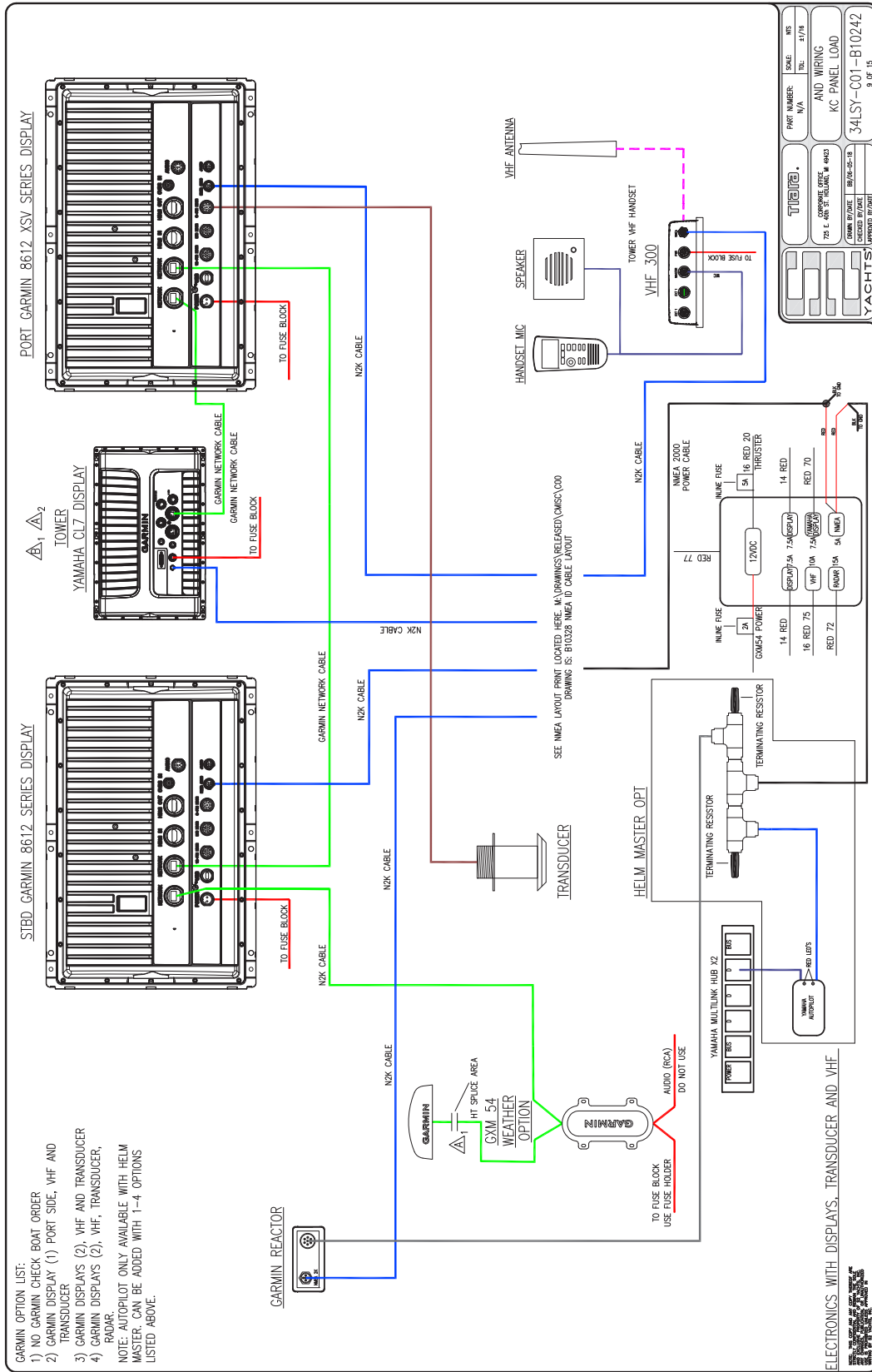

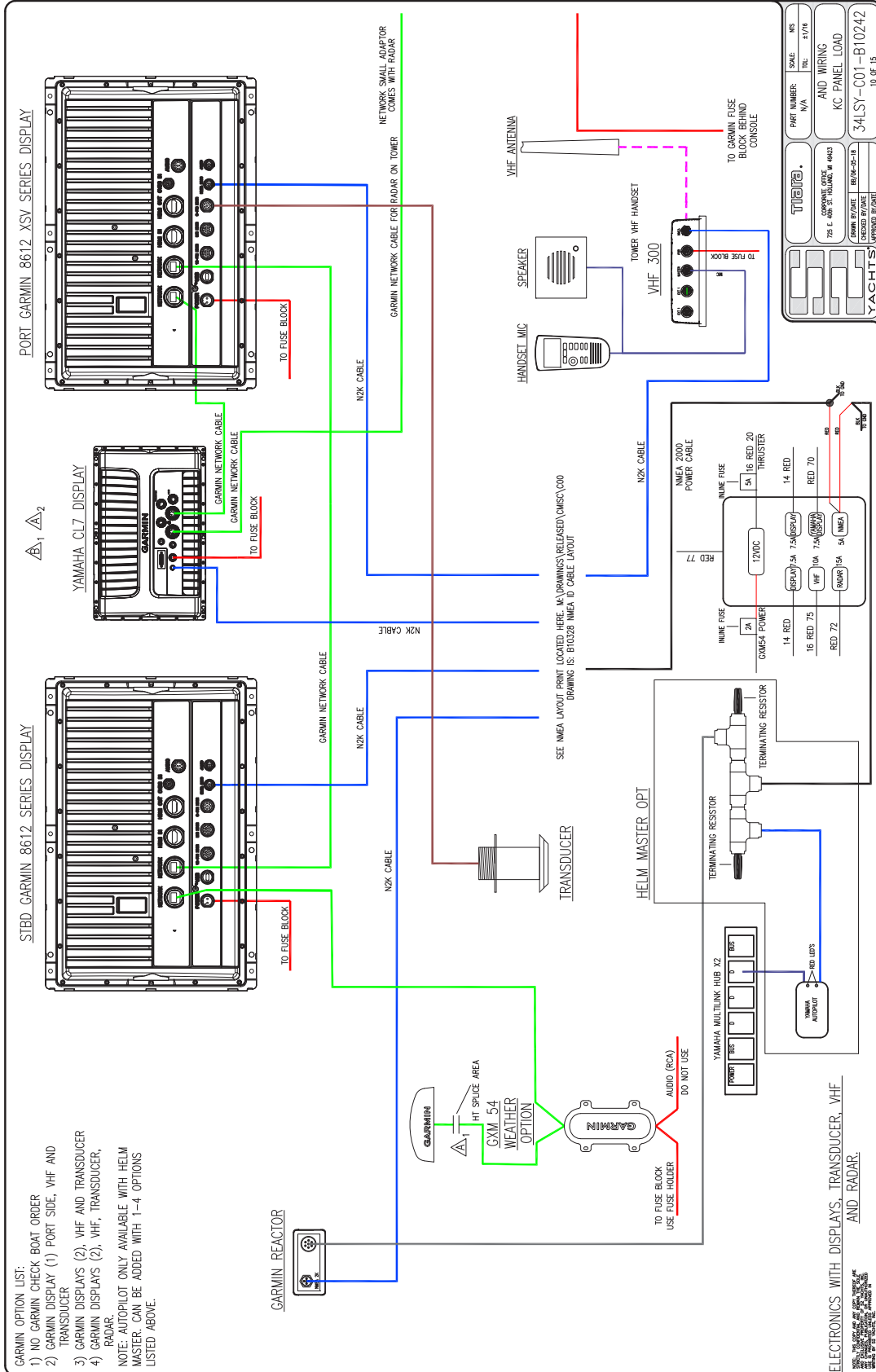

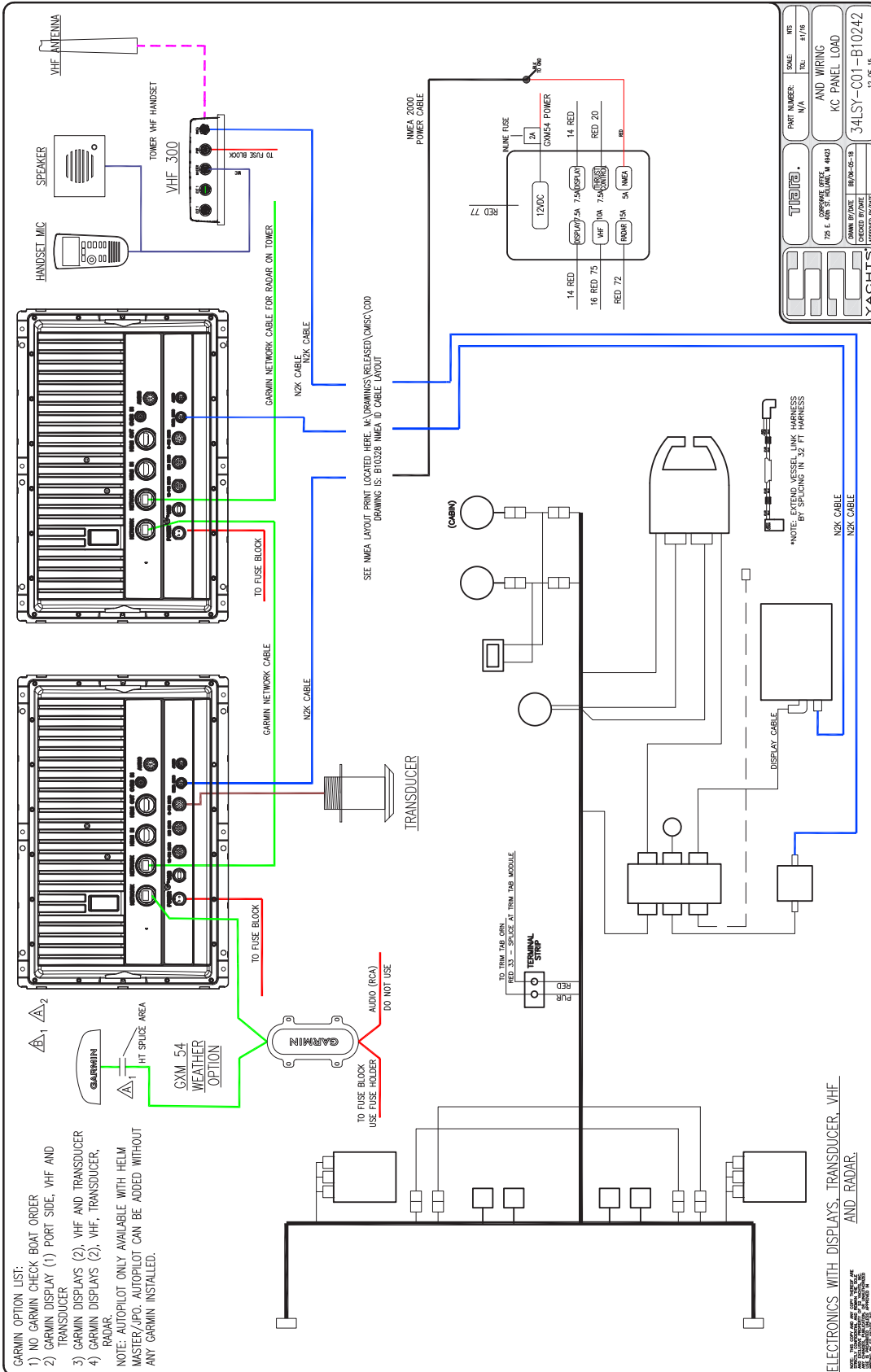

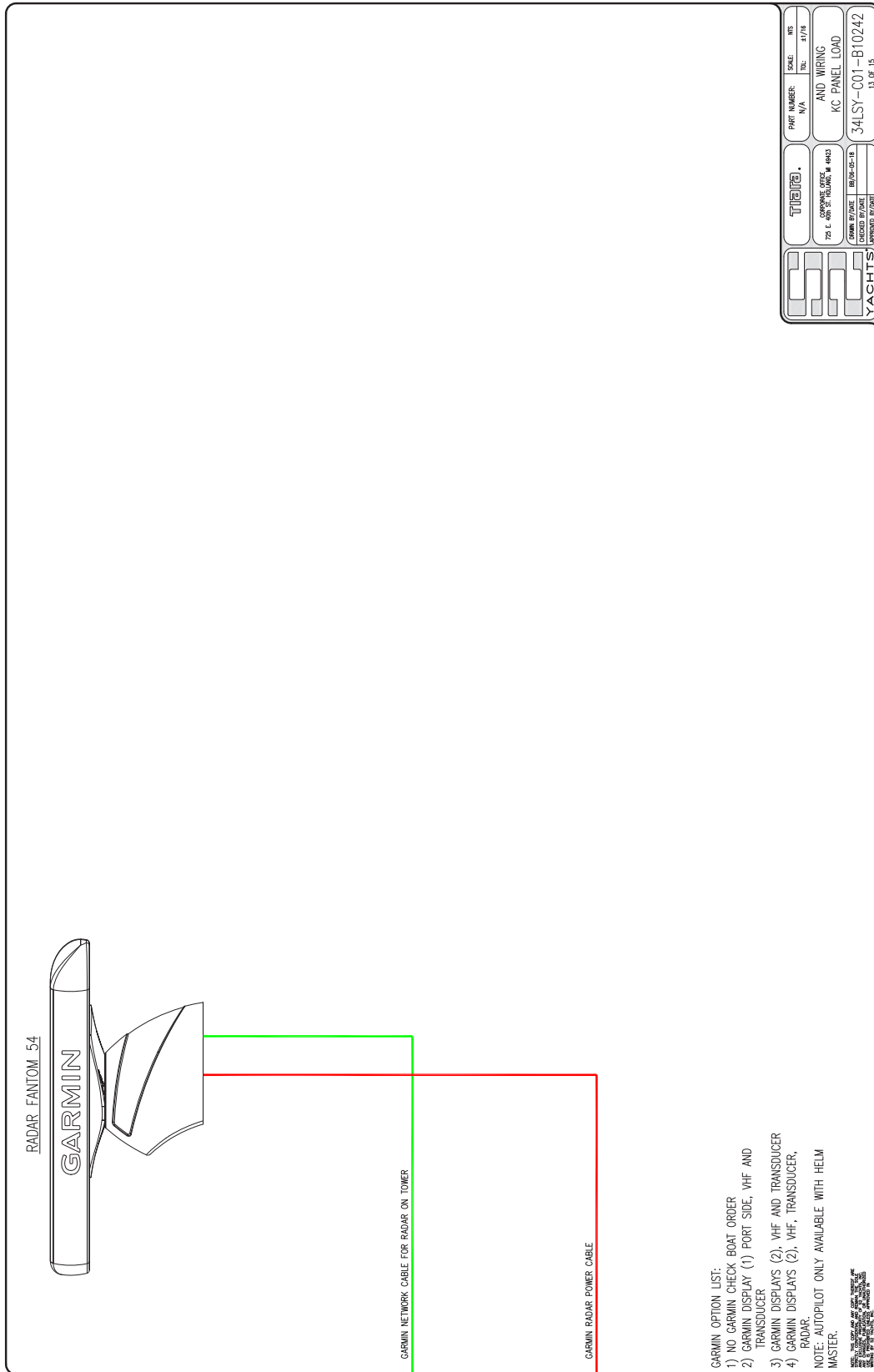

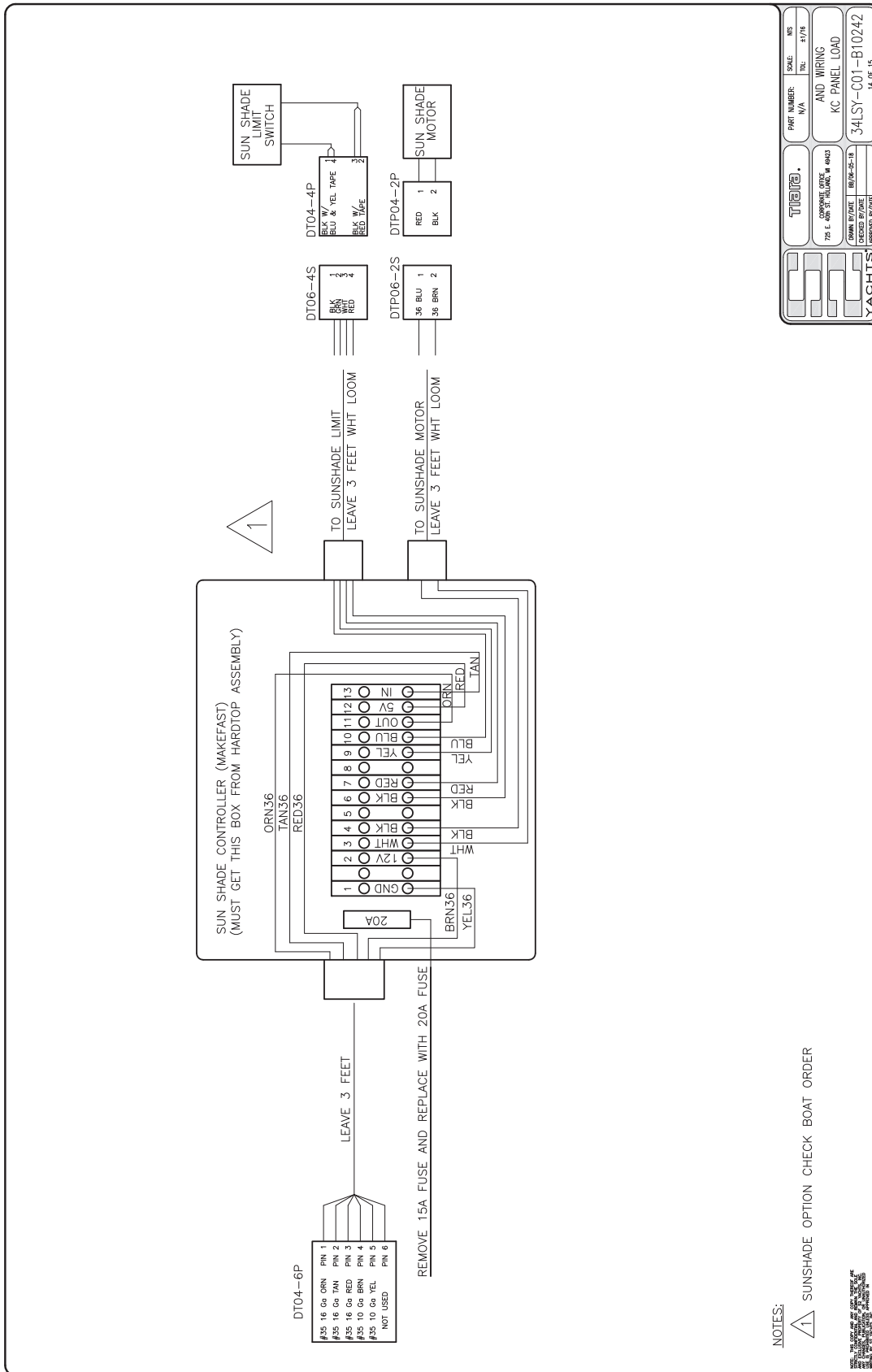

- NOTES:
- 1 COCKPIT AIR OPT BREAKER: CHECK ORDER
 - 2 COCKPIT GRILL: CHECK ORDER
 - 3 AIR COND PUMP: ONLY NEEDED WITH BOTH AIR COND 1 AND 2
 - 4 WATERHEATER OPT BREAKER: CHECK ORDER
 - 5 GENERATOR OPT BREAKER AND SLIDE LOCKOUT: CHECK ORDER

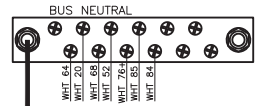
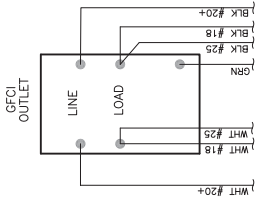
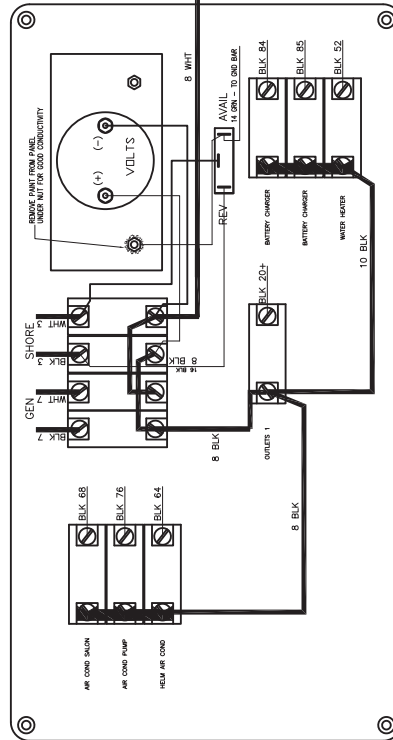
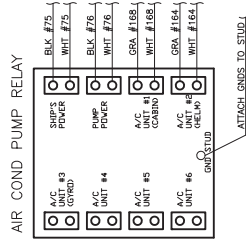
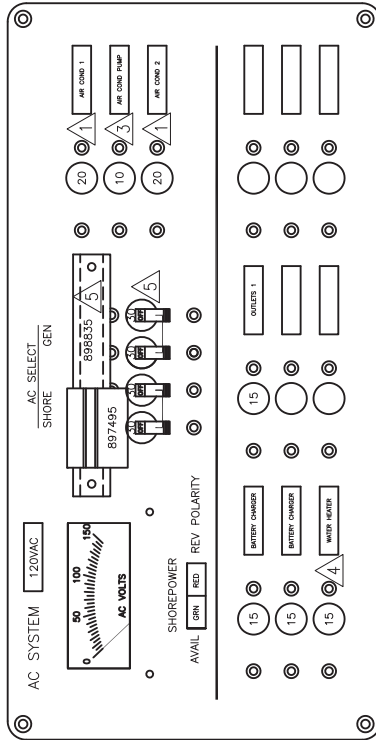

TIARA YACHTS

FOR A COMPLETE CROSS REFERENCE OF PARTS AND WIRING, SEE THE CROSS REFERENCE INDEX ON PAGE 3-200.

DATE: 08/10/2011

REV: 01

34LSY-C01-B10242

3 OF 11

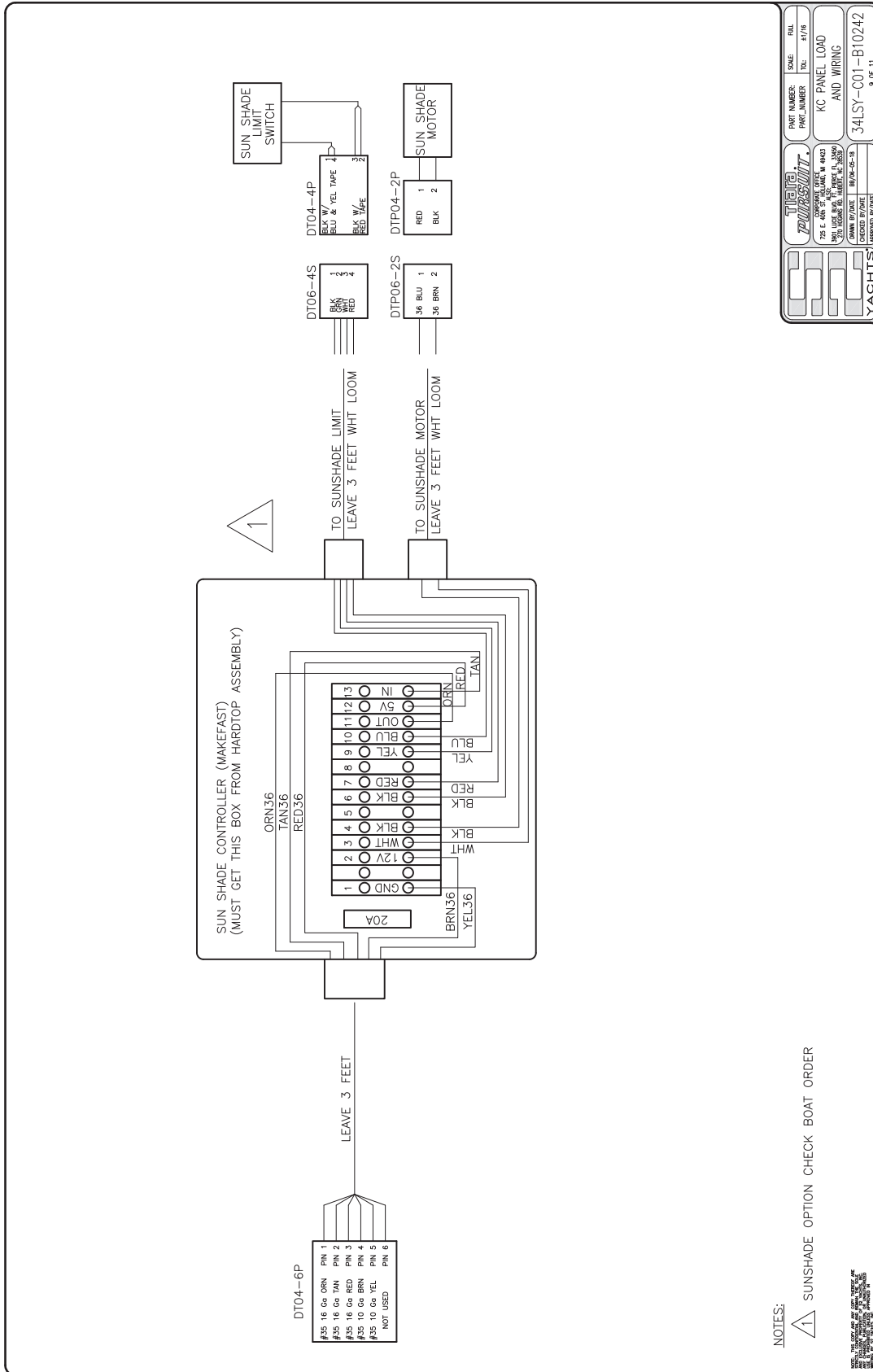

NOTES:

1 SUNSHADE OPTION CHECK BOAT ORDER

© 2015 TIALTA PARSUNITE, INC. ALL RIGHTS RESERVED. THIS DOCUMENT IS THE PROPERTY OF TIALTA PARSUNITE, INC. AND IS NOT TO BE REPRODUCED OR TRANSMITTED IN ANY FORM OR BY ANY MEANS, ELECTRONIC OR MECHANICAL, WITHOUT PERMISSION IN WRITING FROM TIALTA PARSUNITE, INC.

TIALTA PARSUNITE		SCALE: FULL
PART NUMBER: 34LSY-C01-B10242		REV: 1/7/16
KC PANEL LOAD AND WIRING		
DRAWN BY/DATE: BRN-05-15		
APPROVED BY/DATE:		
YACHTS		

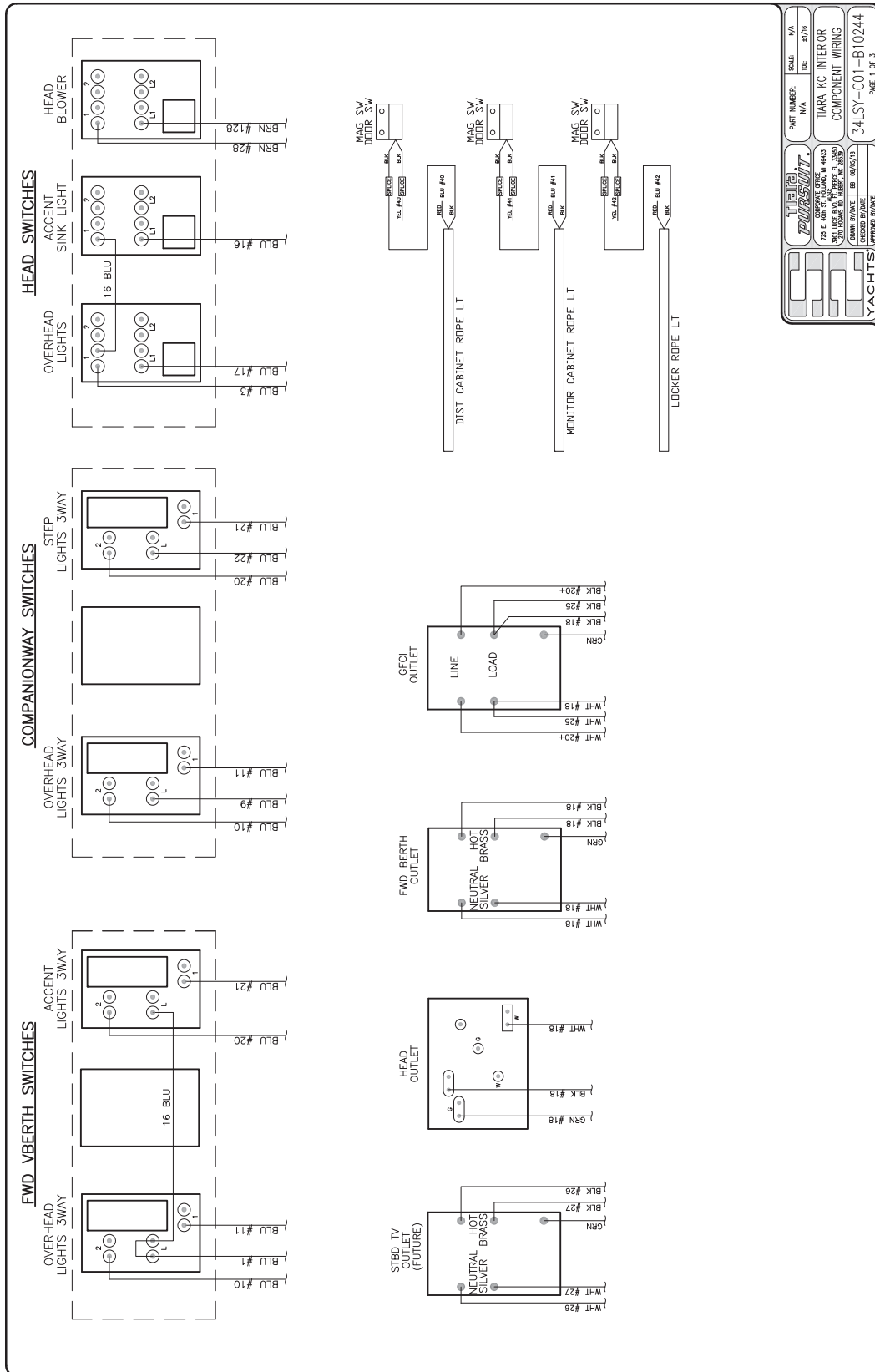

TIARA YACHTS		TIARA YACHTS	
225 E. COMMERCIAL STREET, #400 TAMPA, FL 33601 TEL: 813.281.1111 FAX: 813.281.1112		225 E. COMMERCIAL STREET, #400 TAMPA, FL 33601 TEL: 813.281.1111 FAX: 813.281.1112	
DATE: 08/29/13	BY: [Signature]	SCALE: N/A	DATE: 08/29/13
DESIGNED BY: [Signature]	CHECKED BY: [Signature]	PART NUMBER: N/A	SCALE: N/A
APPROVED BY: [Signature]	DATE: 08/29/13	TIARA YACHTS INTERIOR COMPONENT WIRING	
34LSY-C01-B10244		PAGE 1 OF 3	

Tiara[®]

Y A C H T S

725 E 40th Street, Holland, MI 49423 | 616.392.7163
tiarayachts.com



AMERICAN MADE