

SMART GAS FEATURES



36" SMART GAS RANGETOP

- Hestan Smart Technology creates a seamless cooking experience, allowing the Smart Gas Burner (1) and Smart Pan (1) to work in unison with you.
- Hestan Smart Pan (1 included) features Bluetooth® technology and patented embedded culinary sensors that automatically control cooking temperature as you adjust the AccuKnob™ to your desired temperature.
- 100 to 500°F (in 25°F increments) of precise temperature control is accessible via a unique, industry first, patent-pending touch-screen AccuKnob™ with built-in full color TFT LCD display.



KRTS365 with optional 10" backguard (KBGLB36) model shown



AccuKnob™

- No more LOW, MEDIUM, or HIGH settings. Smart Gas Technology eliminates guessing and instead allows precise and consistent temperature control.

- Dual cooking modes (Temperature Control & Manual) for more versatility.

- In Temperature Control mode, exclusive Smart Technology automatically adjusts the Smart Gas Burner's flame level to reach and maintain the precise target temperature as selected by the user. This Temperature Control mode is only possible using the Hestan Smart Pan.

- In Manual mode, cooking power is displayed by 12 heat settings. This Manual mode can be utilized to cook on any pan.

- AccuKnob™ in Temperature Control mode shows preheat temperature until set / selected temperature is achieved.

- Hestan Smart Gas Burner is a high performance dual-flow gas burner system with significant turndown capability from high Btu performance (20,000 Btu/hour) to low continuous simmer (500 Btu/hour) - NG..

- One single Hestan Smart Gas Burner (right front) and one single Hestan Smart Pan is included in each Hestan Smart Gas product (rangetops or ranges)

- The Hestan Smart Pan has a built-in safety limit of 550°F and the pre-programmed SafeGuard automatic shut-off, which can be programmed to either 4, 8, or 12 hours.

- Embedded sensors can detect the absence of the Hestan Smart Pan immediately, triggering an automatic shut-off.

- Other compatible Hestan smart cookware is also available.

- Personalization options include a choice of languages, as well as a choice between F° or C°.

The Hestan Smart Pan, which is also used for the Hestan Cue-enabled Smart Induction cooktops and portable countertop burner, is included with your Smart Gas product. However, guided cooking features, recipes, etc, are not part of the Smart Gas rangetops or dual fuel ranges. The GloConnect app is not to be confused with the Hestan Cue app.

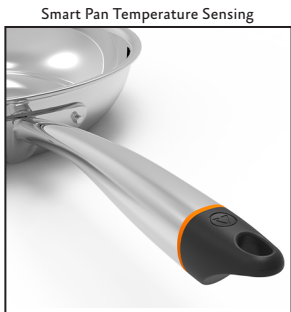

Smart Pan Temperature Sensing



Smart Gas Burner



STANDARD FEATURES

 HESTAN

36" SMART GAS RANGETOP

- Heavy-duty cast-iron grates provide a continuous uninterrupted and maximized cooking surface for best in class coverage. In combination with brass sealed burner and burner bowl, designed to optimize combustion efficiency to produce top cooking performance, including the fastest time-to-boil.

Back-Lit Knobs

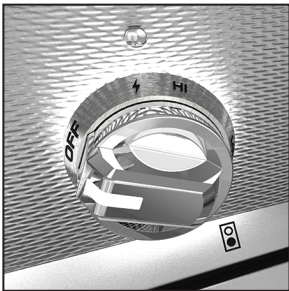

CircuFlame™ Burner

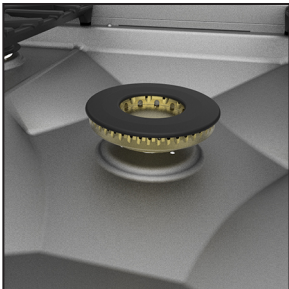

Simmer Flame at 500 Btu



- Award winning CircuFlame™ brass sealed center power burner provides 30,000 Btu/hour of high-performance cooking power, featured in Michelin starred restaurants and used by the top chefs around the country.
- High performance dual-flow burner system allows for significant turndown capability from high Btu performance (23,000 Btu/hour *Left Front Burner*) to low continuous simmer (500 Btu/hour *All Burners*). - NG
- Patented, diamond stainless steel burner bowl, emphasizes the CircuFlame™ power burner. Allows for ease of cleaning with a water tight seal.
- Exclusive raised pattern burner cap design that is easy to remove and clean.
- Robust electronic ignition/re-ignition capability to provide safety and proper gas ignition. Igniter will continue to spark until the burner flame is established, and re-ignite in the case of flame blow out.
- Precision temperature control delivers consistent cooking results.
- Bluetooth Connectivity with precision temperature control.
- Industry exclusive Marquise Accented™ control panel.
- Elegantly backlit patent pending control knobs add functionality and brilliant illumination.
- Zamak die-cast control knobs.
- Comes standard with Island Trim

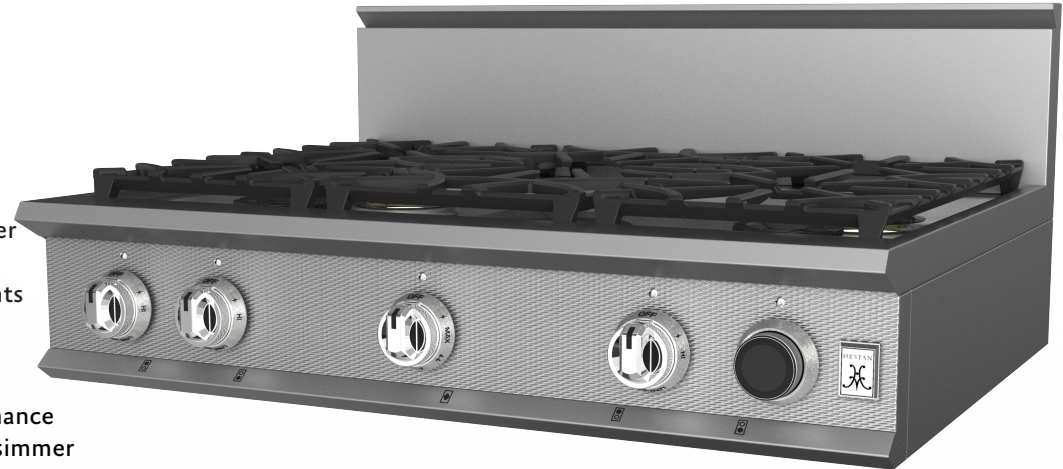

*KRTS365 with optional
10" backguard (KBGLB36)
model shown*

OPTIONS & ACCESSORIES

- Available in Twelve (12) Hestan signature color finishes
- Backguards : Low Back 10" and High Shelf 20"
- Natural Gas (NG) or Liquid Propane (LP)
- Gas conversion kits (NG/LP)
- High altitude kit
- Wok Ring

SIDE VIEW

INSTALLATION CLEARANCES WITH ISLAND TRIM

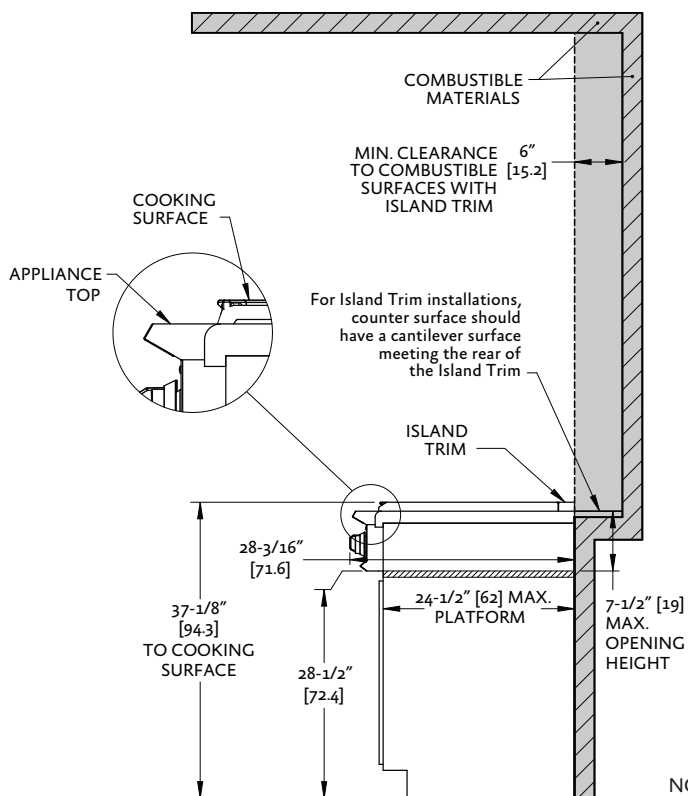

DIMENSIONS IN BRACKETS [] ARE IN CM.

INSTALLATION CLEARANCES 36" WITH ISLAND TRIM

FRONT VIEW

RANGETOP MODEL	W	V (MIN)
KRTS365	36" [91.4]	30" [76.2]

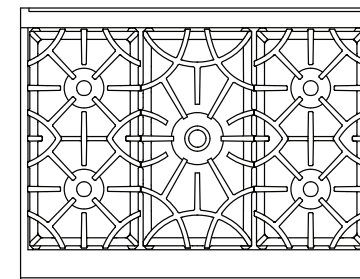
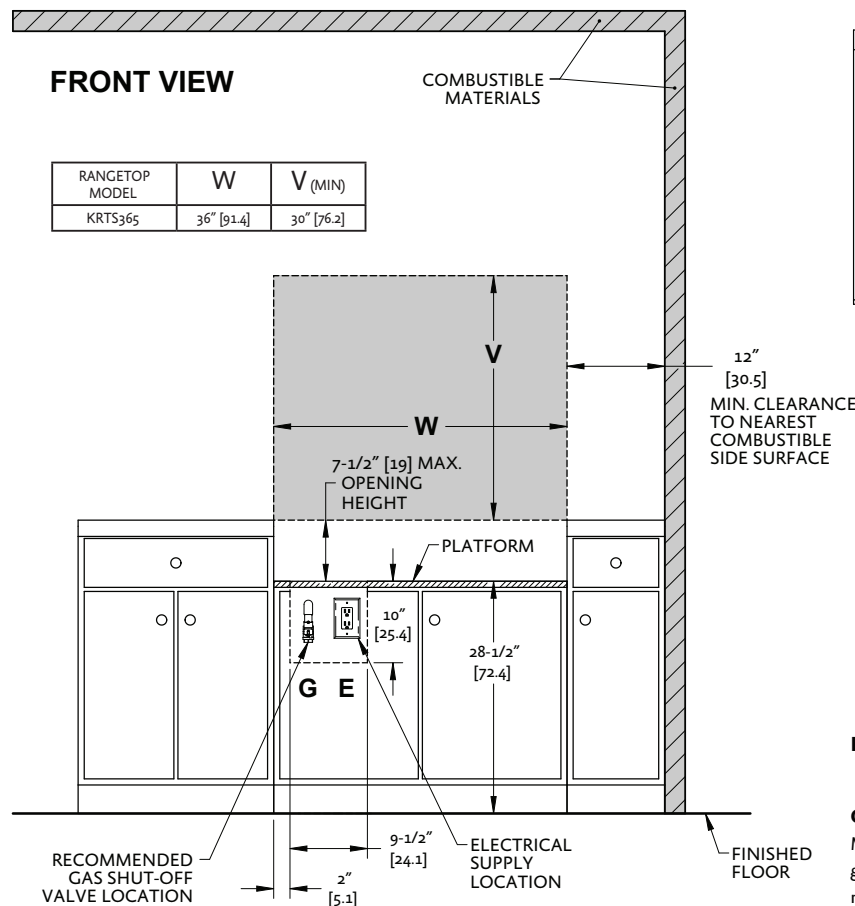

KRTS365

ELECTRICAL REQUIREMENTS:
120V, 60Hz, 15 amps

GAS REQUIREMENTS: 3/4" MNPT gas connection. Minimum gas supply is 7" water column for natural gas and 11" for propane. Operating pressure at the manifold is 5" water column for natural gas and 10" for propane. All units require a regulated gas supply. (included)

Hestan Indoor products are approved for indoor use only. Hestan Commercial Corporation reserves the right to change materials and specifications without notice. Please reference our Installation Instructions for more elaborate detail and as the main source in your dimensional planning. Specify type of gas when ordering.



NOTES:

- SHADED AREAS INDICATE WHERE COMBUSTIBLE MATERIALS ARE NOT ALLOWED.
- APPLIANCE TOP MUST BE LEVEL OR HIGHER THAN THE ADJACENT COUNTERTOP SURFACES.
- "G" IS GAS CONNECTION ZONE ON REAR WALL. MOUNT SHUT-OFF VALVE AS HIGH AS POSSIBLE IN THIS ZONE FOR EASY ACCESS WHEN RANGETOP IS INSTALLED.
- "E" IS ELECTRICAL SUPPLY ZONE.
- "W" IS APPLIANCE OPENING.
- NOTE: HANDLE END CAPS PROTRUDE 1/8" BEYOND EACH SIDE OF THE RANGE. ALLOWANCE MAY BE NEEDED FOR ADJACENT DRAWERS OR CABINETRY.
- "V" IS MIN. CLEARANCE TO REQUIRED VENTILATION HOOD.

ALL Models	Description	Cutout Dimensions			Total Btu's	Circuit Breaker Req	Approx SHP WT (lbs)
		W (in.)	D (in.)	H (in.)			
KRTS365-NG/-LP	36" Rangetop with 4 burners + 1 Smart Burner	36"	24-1/2"	7-3/8"	104,000	15 Amp	230



CONTACT US: www.hestanhome.com phone 888.905.7463 3375 E. La Palma Ave., Anaheim, CA 92806