



Grow and Go ARB Grow and Go ARB Sport MultiFit ARB Continuum ARB

All-in-One Car Seat



Model shown may differ from model purchased.

KEEP INSTRUCTIONS FOR FUTURE USE.
Read all instructions before using this car seat.

WARNING  Failure to follow the warnings on the labels and in the instruction manual can result in serious injury or death to your child.

©2022 Dorel Juvenile Group, Inc. Safety 1st™ and the Safety 1st logo and design are trademarks of Dorel Juvenile Group, Inc. (800) 544-1108 www.safety1st.com. Styles and colors may vary. Los estilos y los colores pueden variar. Made in USA from American and imported parts (including seat pad). Hecho en EE.UU. a partir de piezas americanas e importadas (incluyendo la almohadilla del asiento). Distributed by (distribuido por) Dorel Juvenile Group, Inc., 2525 State St., Columbus, IN 47201-7494. Dorel Juvenile Canada, 2233 Argenta Road, Suite 110, Mississauga, ON L5N 2X7. Importado y Distribuido en Chile por: Comercial e Industrial Silfa S.A. - San Ignacio 0201 / Parque Industrial Portezuelo Quilicura, Santiago Chile. Fono (562) 2339 9000. En Perú por: Comexa S.A. - Los Libertadores 455 - San Isidro, Lima - Perú. Fono (511) 4469014. En Centro América, Caribe y Ecuador por: Best Brands Group S.A. - Av. Balboa, Bay Mall Plaza, Planta Baja, local 9, Panamá. - Fono: (507) 300 2884. En Colombia por: Baby Universe S.A.S. - Via 40 No. 77-29, Barranquilla, Colombia - Fono: (575) 353 1110 Importador: DJGM, S.A. DE C.V. Gabriel Mancera No. 1041 Col. Del Valle, Benito Juárez C.P. 03100 México, Ciudad de México R.F.C. DJG140305GN9 Tel. (55) 67199202



4358-8142A
06.08.22



Overview

Welcome to the Safety 1st family and thank you for choosing this car seat, also known as a child restraint!

To help you get started using your child's new car seat, here are the 4 main tasks you'll need to complete.



Measure Your Child



Adjust the Car Seat to Fit Your Child



Install the Car Seat into Your Vehicle



Secure Your Child in the Car Seat

Your child's safety is worth the time it will take to read and follow these instructions.

Ready? Let's go!

Pages 1-2 will introduce you to the parts of the car seat.

Page 78 has our contact information. If at any point you would like assistance, please feel free to reach out to us.

Quick Navigation

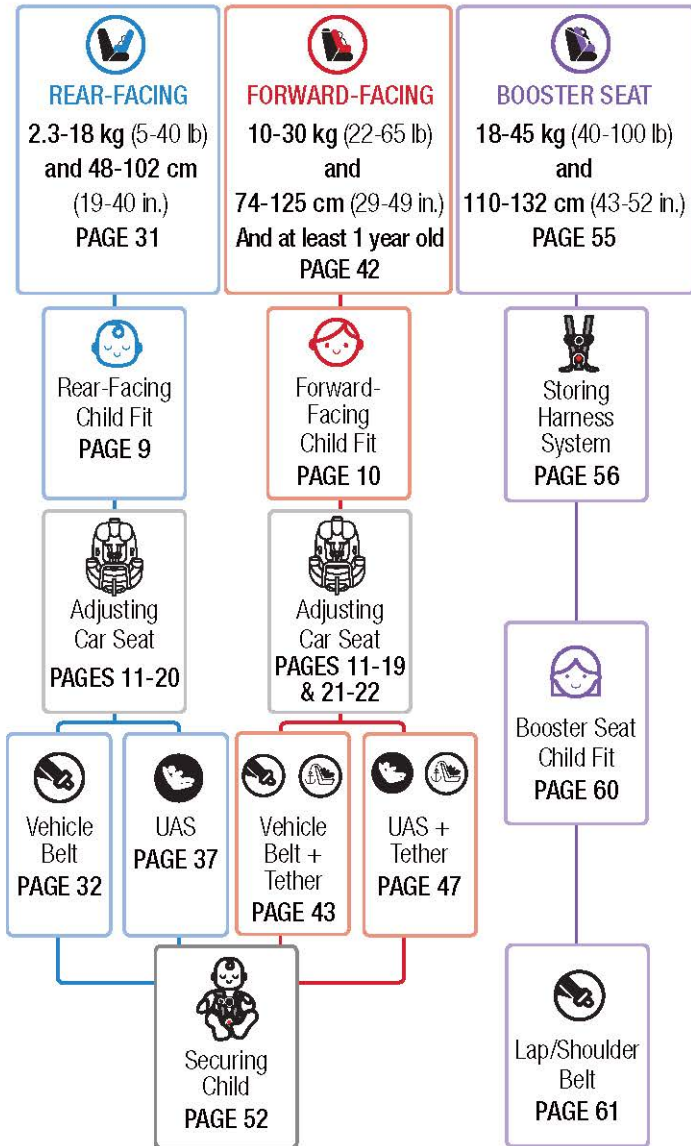

Contents

Getting Started

Parts of the Car Seat	1
Accessory Use	3
Choosing Car Seat Mode	6
Preparing Car Seat for Child Fit.....	8
Rear-Facing Child Fit	10
Forward-Facing Child Fit.....	11

Making Adjustments to Car Seat

Changing Headrest/Harness Height	12
Changing Buckle Position	13
Harness System Adjustments for Smaller Infants	15
Reclining the Car Seat	19
Installing Anti-Rebound Bar	20
Removing Anti-Rebound Bar	21

Choosing UAS or Vehicle Belt

UAS Use	23
Vehicle Belts	25
Tether Use	29

Installation in Vehicle

Rear-Facing Mode	31
Rear-Facing Vehicle Belt Install.....	32
Rear-Facing UAS Install.....	37
Forward-Facing Mode	42
Forward-Facing Vehicle Belt + Tether Install.....	43
Forward-Facing UAS + Tether Install	47

Securing Child in Car Seat	52
---	----

Booster Seat

Booster Seat Mode	55
Storing Harness System	56
Booster Seat Child Fit	60
Lap/Shoulder Belt Use	61

Wash & Care of Car Seat Parts

Removing Seat Pad Set for Cleaning	63
Cleaning Parts of Car Seat & Installing Seat Pad Set ..	66
Installing Harness System	68

Safety Information

Aircraft Information	71
Replacement and Expiration of Car Seat	72
Child Restraint Use.....	73
Installation in Vehicle.....	73
Transport Canada Regulations.....	73
Vehicle Seating Position	74
Registration and Safety Notices	75

Additional Information

Warranty	76
Troubleshooting	76
Replacement Parts List	77
Dorel Juvenile Group Information.....	78

Parts of the Car Seat

Model shown may differ from model purchased.

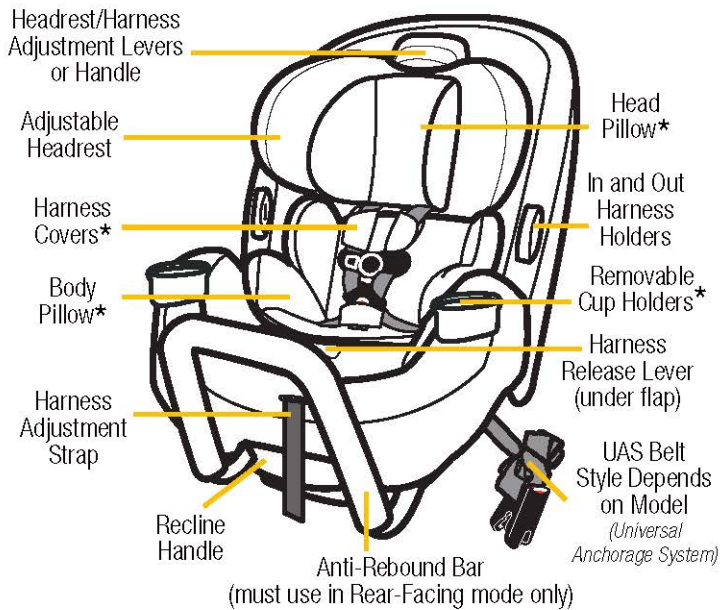

Harness System Detail



*See pages 3-5 for Accessory Use.

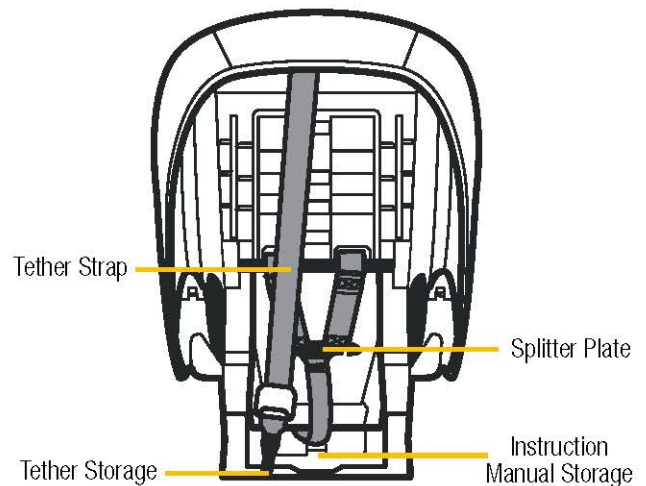
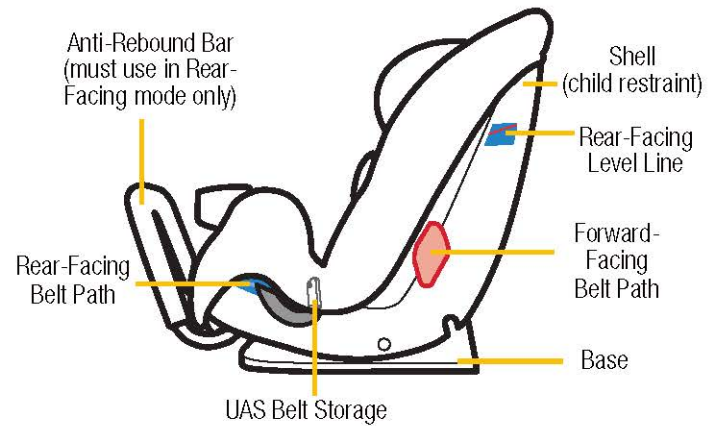



For Use in Rear-Facing
or Forward-Facing Mode

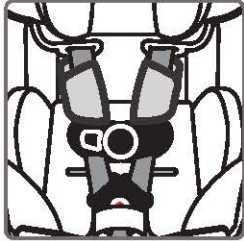

Harness Covers

Harness covers help provide comfort to the neck.

If the harness covers will not allow proper positioning of the chest clip or interfere with getting a tight enough harness fit for a smaller baby, remove and do not use.

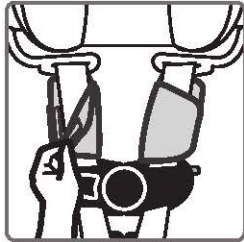

Store until your child is large enough to use these harness covers while maintaining a properly fitting harness.

There are different harness cover styles depending on your model.

To remove harness covers with fastening strips, pull the fastening strips apart and pull them off of the harness strap.

To remove harness covers without fastening strips, unhook the harness strap from splitter plate, pull harness strap out of the upper harness slots and remove harness covers.

Rethread harness strap and attach the harness strap loops to the splitter plate.



For Use in Rear-Facing
or Forward-Facing Mode

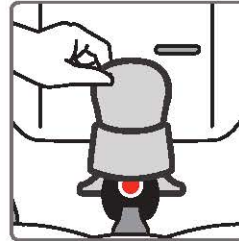

Buckle Cover

(on select models)

To remove buckle cover, slide the ends out of the buckle strap slot in pad. Pull up and off of the buckle.

To install buckle cover, slide buckle cover over buckle and tuck ends of buckle cover into buckle strap slot in pad.

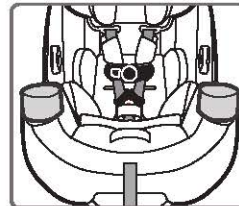

Removable Cup Holders

(on select models)

The cup holders are top-rack dishwasher safe.

To remove cup holder, twist the cup holder counterclockwise. Pull it out of slot in shell.



To install cup holder, align tabs on bottom of cup holder with slots in shell. Twist clockwise to lock in place.





For Use in Rear-Facing Mode Only

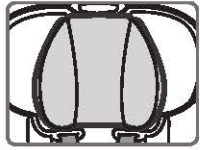

Head Pillow

To remove head pillow, gently pull tabs on back of head pillow out of headrest pad.

To attach the head pillow, slide the tabs on back of head pillow into slots in headrest pad.

Body Pillow

There are 2 different body pillow styles depending on your model.

When using the lower shoulder harness slots for smaller infants, you **must** use the body pillow.

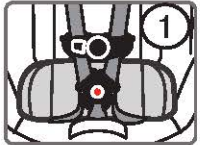

Style 1

To remove: Slide pillow out from behind the harness straps.

To install: Slide pillow in behind the harness straps.

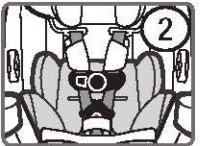

Style 2

When using upper shoulder harness slots:

To remove: Undo the buckle and pull buckle through the slot in pillow. Slide pillow out from behind the harness straps.

To install: Slide pillow in behind harness straps and pull buckle through buckle slot in pillow.

When using lower shoulder harness slots for smaller infants:

To remove: From the back of seat, remove harness strap loops from splitter plate. From the front, pull harness straps out of shell and body pillow. Undo the buckle. Pull buckle through slot in pillow and pull pillow out of seat.

Rethread harness for upper harness slots, see pages 68-70.

To install: From the back of seat, remove harness strap loops from splitter plate. From the front, pull harness straps out of shoulder slots. Place pillow in seat and pull buckle through buckle slot in pad. Rethread harness straps for smaller infants through pillow and shell, see pages 15-18.



Measure your child's weight and height (do not guess) before choosing the car seat's mode.

Your child's height, weight, and age determine how the car seat should be placed in the vehicle.

Children vary widely in body size, shape, and temperament—**please consult your doctor before switching between any of these modes within the limits and fit requirements of the seat.**

Provincial Laws

Please be certain to follow your province's laws regarding car seat use.

American Academy of Pediatrics Recommendations

Infants and Toddlers

Should ride in a rear-facing car seat as long as possible, until they reach the highest weight or height allowed by their seat.

Toddlers and Preschoolers

Once they are facing-forward, children should use a forward-facing car seat with a harness for as long as possible, until they reach the height and weight limits for their seats.

School-Aged Children

Once they have outgrown their forward-facing car seat, children should use a belt-positioning booster seat until the vehicle's lap and shoulder seat belt fits properly. This is often when they have reached at least 4 feet 9 inches in height and are 8 to 12 years old.

Older Children

All children younger than 13 years should be restrained in the rear seats of vehicles for optimal protection.



REAR-FACING MODE

2.3-18 kg (5-40 lb) and 48-102 cm (19-40 in.)

Children under 1 year of age must ride **Rear-Facing**.

In this car seat, your child can remain **Rear-Facing** until they outgrow any one of the following:

- **Weight Limit:** 18 kg (40 lb); OR
- **Height Limit:** 102 cm (40 in.); OR
- **Rear-Facing** child fit requirements. See page 10.



FORWARD-FACING MODE

10-30 kg (22-65 lb) and 74-125 cm (29-49 in.)

Children must be at least 1 year of age to ride **Forward-Facing**.

In this car seat, your child can remain harnessed **Forward-Facing** until they outgrow any one of the following:

- **Weight Limit:** 30 kg (65 lb); OR
- **Height Limit:** 125 cm (49 in.); OR
- **Forward-Facing** child fit requirements. See page 11.



BOOSTER SEAT MODE

18-45 kg (40-100 lb) and 110-132 cm (43-52 in.)

In this car seat, your child can remain in a **Booster Seat** until they outgrow any one of the following:

- **Weight Limit:** 45 kg (100 lb); OR
- **Height Limit:** 132 cm (52 in.); OR
- **Booster Seat** child fit requirements. See page 60.

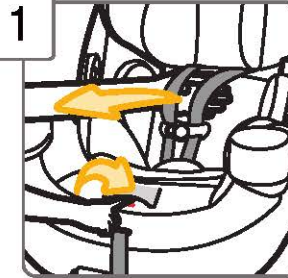

1 Fully Loosen Harness Straps

Push down on harness release lever (through opening in pad) while pulling out on harness straps as shown.

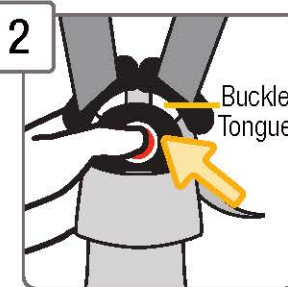

2 Unbuckle Harness

Press in towards the **top** of the red button to release the buckle tongues.

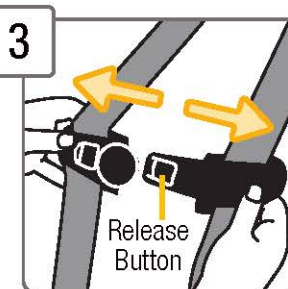

3 Release Chest Clip

Hold each side of the chest clip and press on the release button with your thumb and pull apart.

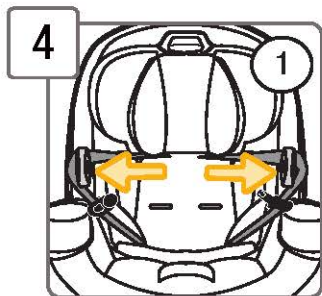

4 Place Harness Straps Out of the Way

The In and Out Harness Holders can be used two ways:

1. You can secure the harness straps around them as shown.
2. Or the buckle tongues can be placed into the slots in the harness holders as shown.

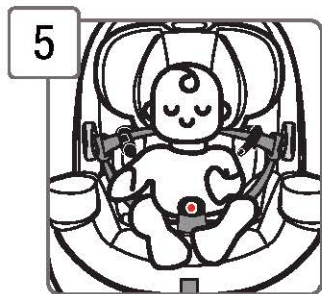
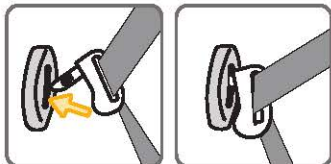

5 Place Child in Car Seat to Determine Proper Harness Fit

The child's bottom and back should be flat against the car seat.

For **Rear-Facing** child fit, see page 10.

For **Forward-Facing** child fit, see page 11.

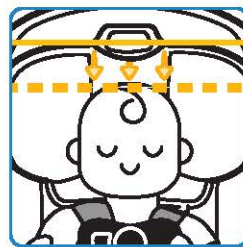

Head Position

The top of your child's head **must be at least 2.5 cm (1 in.) below** the top of the car seat's headrest.



Harness Strap Position

The harness strap **must be at or slightly below** the shoulders; **never above**.

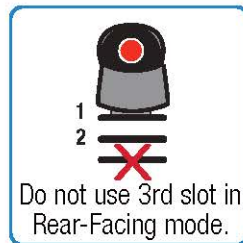

Buckle Position

Buckle must be used in either the **1st or 2nd slot**. Choose the slot closest to your child.

The buckle **should not be underneath or behind** your child.

Need to make adjustments?

To change headrest/harness height, see page 12.

To change buckle position, see pages 13-14.

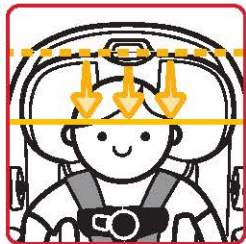

Head Position

The tops of your child's ears **must be below** the top of the car seat's headrest.

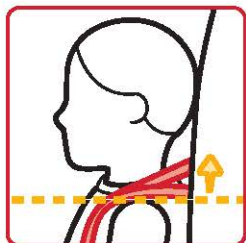

Harness Strap Position

The harness strap **must be at or slightly above** the shoulders; **never below**.

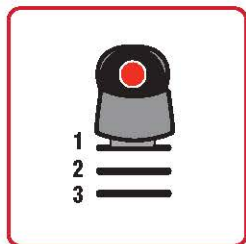

Buckle Position

Buckle can be used in **any slot**. Choose the slot closest to your child.

The buckle **should not be underneath or behind** your child.

Need to make adjustments?

To change headrest/harness height, see page 12.

To change buckle position, see pages 13-14.

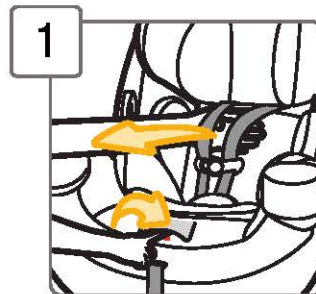

1 Fully Loosen Harness Straps

Push down on harness release lever (through opening in pad) while pulling out on harness straps as shown.

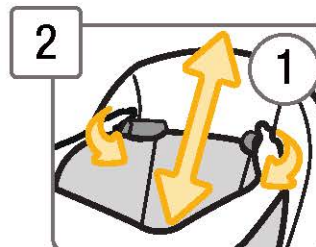

2 Changing Headrest/ Harness Height

There are 2 different headrests depending on your model.

STYLE 1

Rotate the headrest/harness adjustment levers inward.

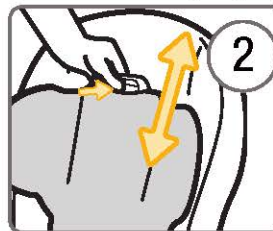

STYLE 2

Squeeze the headrest/harness adjustment handle lever up.

Move the headrest up or down to the proper height for your child.

Release the levers or handle to lock in place.

Make sure it is locked securely.

For Rear-Facing child fit, see page 10.

For Forward-Facing child fit, see page 11.

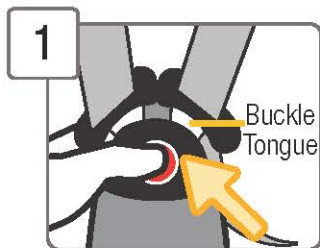

Unbuckle Harness

Press in towards the **top** of the red button to release the buckle tongues.

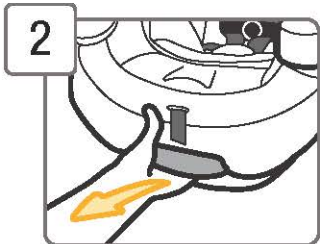

Fully Recline the Car Seat

Pull out on recline handle and push top of child restraint back.

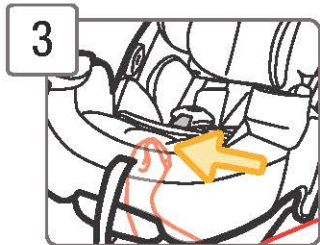

Locate the Buckle's Metal Retainer

Reach under the seat between the base and shell and through the recline handle.

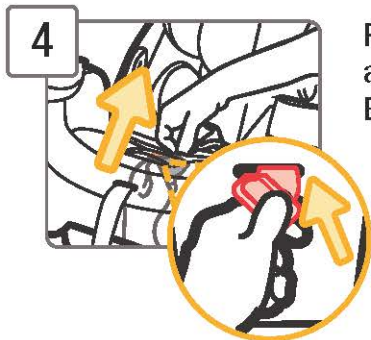

Rotate Metal Retainer and Push It Up Through Buckle Slot in Shell

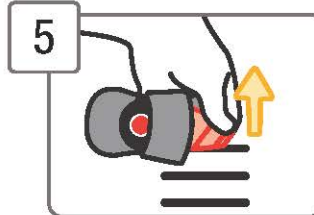

From Top of Seat, Pull Buckle Out of Shell and Pad

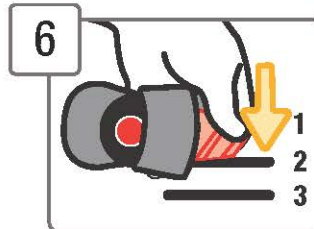

Insert Buckle's Metal Retainer into Slot Closest to Child

Buckle **must** face out.

Rear-Facing Mode: You must use the 1st or 2nd buckle slots. **Forward-Facing Mode:** Any slot can be used.

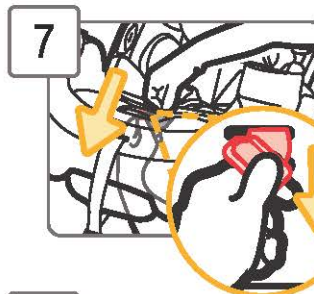

Reach Under the Seat Between Base and Shell and Through Recline Handle

Pull buckle's metal retainer completely through pad and shell.

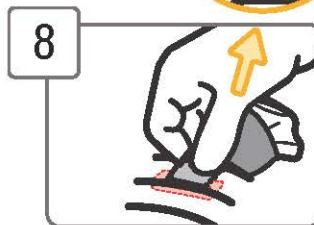

Check Buckle

Pull up on buckle to make sure it is secured.

The buckle **must not** pull out.

If you cannot achieve a snug harness fit for your child, see pages 15-18.

To learn how to check harness tightness, see pages 52-54.

⚠ Failure to place buckle's metal retainer completely through pad and shell can result in serious injury or death.

Harness System Adjustments for Smaller Infants

If you cannot achieve a snug harness fit for your child, make these adjustments.

When using the lower shoulder harness slots for smaller children, you **MUST** use the body pillow and the headrest **MUST** be in the lowest position.

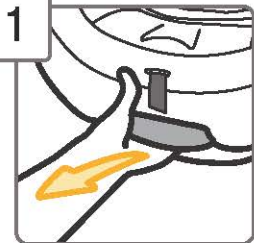

1

With Buckle in the 1st Slot, Fully Recline the Car Seat

If you need to move the buckle to the 1st slot, see pages 13-14.

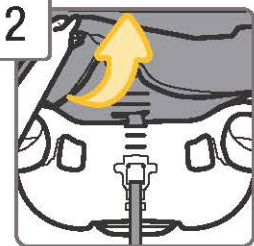

2

Pull Up Front of Car Seat Pad

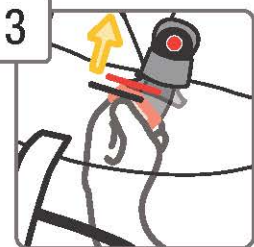

3

From Bottom of Seat, Pull Metal Retainer Down and Push It Up into Middle Slot As Shown

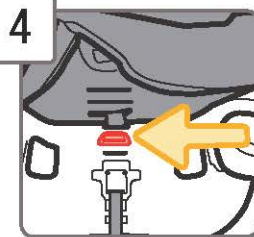

4

From Top of Seat, Lay the Metal Retainer Flat Against the Shell As Shown

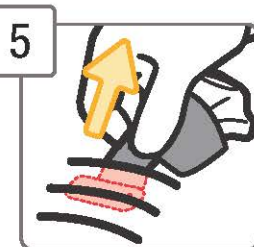

5

Tuck Car Seat Pad Back Around Front of Car Seat and Check Buckle

Pull up on buckle to make sure it is secured.

The buckle **must not** pull out.

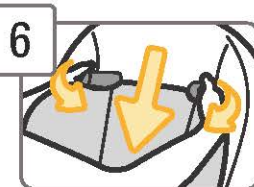

6

Adjust the Headrest to the Lowest Position

The headrest **must** be in the lowest position.



7

Fully Loosen Harness Straps

Push down on harness release lever (through opening in pad) while pulling out on harness straps as shown.

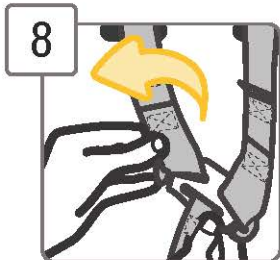

8 From Back of Seat,
Remove Harness Strap
Loops From Splitter Plate

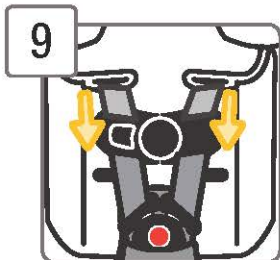

9 Pull Harness Straps Out of
Upper Shoulder Harness
Slots

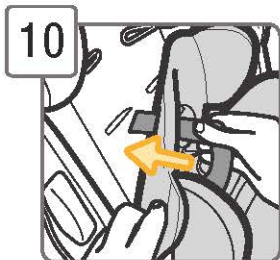

10 Pull Body Pillow (Style 2)
Forward Away from Seat

Thread harness straps through slots in body pillow (style 2).

You **must** use the body pillow (style 1 or 2).

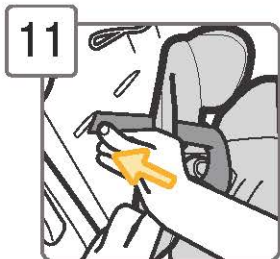

11 Thread Harness Straps
Through Lower Shoulder
Harness Slots For Smaller
Infants in Seat Pad and Shell

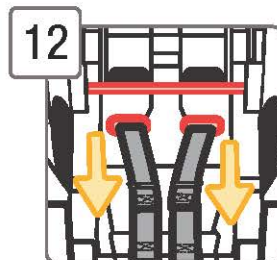

12 From Back of Seat, Pull
Harness Straps Through
Shell

Harness straps **must** be in shoulder harness slots **below** the metal bar as shown.

Do **not** twist harness straps.



13 Attach 2nd Harness Strap
Loops to Splitter Plate As
Shown

Sewn ends of the harness strap loops **must** face towards you.

Do **not** twist harness straps or harness adjustment strap.

Make sure the same harness strap loops are fitted **completely** on both sides of the splitter plate.

Check your child's fit often.

The harness strap **must** be returned to the upper shoulder harness slots as your child grows.

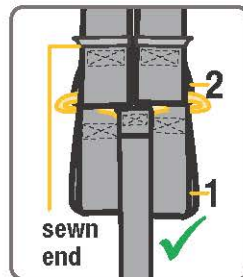

⚠ The harness system must be installed correctly. Do not use a child restraint with damaged harness straps.

This car seat has 3 positions.

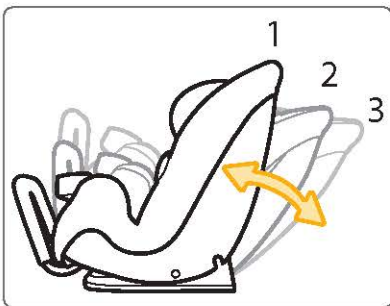

Rear-Facing Mode - 3 Reclined or 2 Semi-Reclined

The level line on shell **must** be parallel with the ground using either position 3 or 2.

Forward-Facing Mode - 1 Upright or 2 Semi-Reclined*

Booster Seat Mode - 1 Upright or 2 Semi-Reclined*

* When used in **Forward-Facing** or **Booster Seat** mode, the semi-reclined position is to be used only to install the child restraint or booster seat flush against the vehicle seat back. Vehicle seat back must be upright.

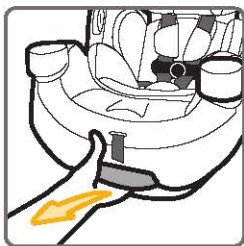

To Recline: Pull out on recline handle and push top of child restraint back.

For More Upright: Pull out on recline handle and pull top of child restraint forward.

The anti-rebound bar must be used in **Rear-Facing Mode**.

The anti-rebound bar must be removed when using **Forward-Facing** or **Booster Seat Mode**.

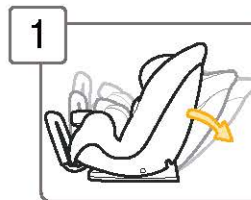

1 Fully Recline Car Seat

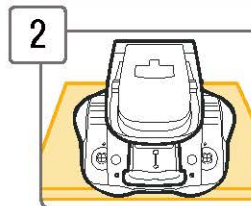

2 Place Car Seat Upside Down on Stable Flat Surface

Line the bottom of the car seat up with the edge of the surface as shown.

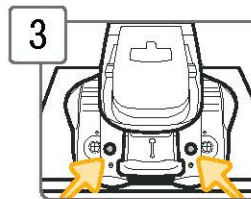

3 Locate Anti-Rebound Bar Connection Openings in Car Seat

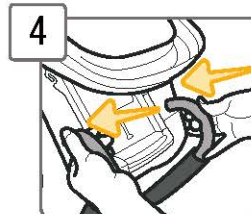

4 Attach Anti-Rebound Bar to Car Seat

Firmly push the ends of the anti-rebound bar into the openings in the car seat until the bar cannot go any farther.

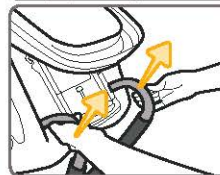

Pull up on anti-rebound bar to make sure it is locked securely in place.

The anti-rebound bar must be removed when using **Forward-Facing** or **Booster Seat Mode**.

The anti-rebound bar must be used in **Rear-Facing Mode**.

1



Fully Recline Car Seat

2

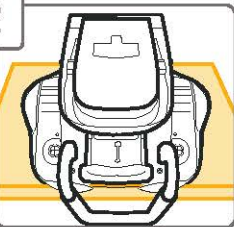

Place Car Seat Upside Down on Stable Flat Surface

Pull the car seat to the edge of surface so the anti-rebound bar hangs over the edge as shown.

3

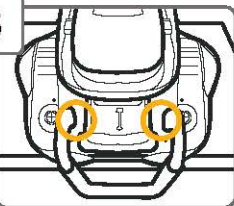

Locate Anti-Rebound Bar Release Tabs

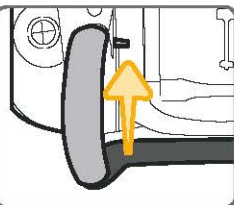

4

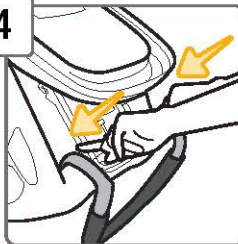

Release Anti-Rebound Bar

With index finger, push down on both release tabs while gently pulling the bar towards you.

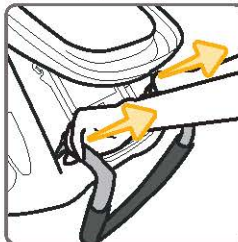

5

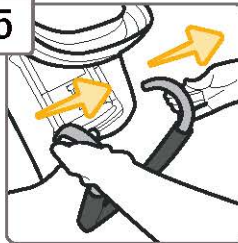

Pull Anti-Rebound Bar Out of Car Seat As Shown

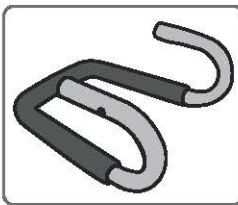

Store anti-rebound bar for future use in **Rear-Facing Mode**.



For Use in Rear-Facing or Forward-Facing Mode

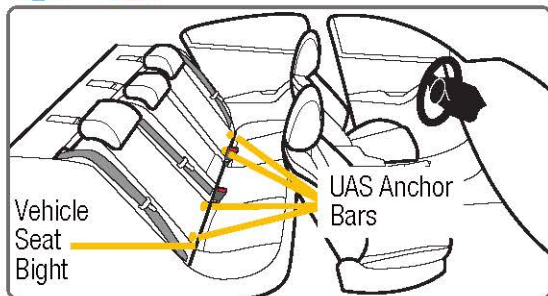

Your vehicle's features may be considerably different than those pictured here.

The UAS (Universal Anchorage System) is a universal system for installing child restraints without using vehicle seat belts.

The UAS can **ONLY** be used in vehicles that have the UAS bars installed in designated seating positions. Most vehicles manufactured after September 2002 are equipped with UAS bars.

Check your vehicle owner's manual to see which seating positions may be equipped with UAS bars.



Do not use both the UAS belt and vehicle belt at the same time.

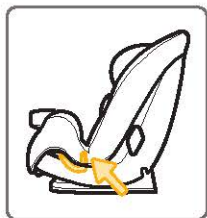

UAS Belt Storage Location

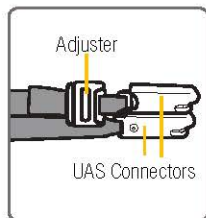

**UAS Belt Parts
Style Depends on Model**

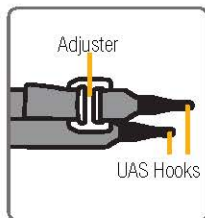

To Remove UAS Belt from Storage Location on Car Seat:

For UAS Connectors: Press the red release button on each connector and remove connectors from the storage attachments.

For UAS Hooks: Squeeze the spring lever on the hooks and remove the hooks from the storage attachments.

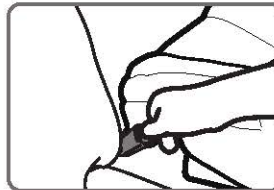

To Remove UAS Belt from Vehicle UAS Bars:

For UAS Connectors: Press the red release button on each connector, then pull the connectors out of the vehicle seat.

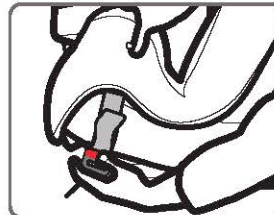

For UAS Hooks: Remove the tension from the belt by pushing down on the side of the car seat with the adjuster. Then press the adjuster's button to loosen the belt.



Remove the hook from the anchor by squeezing the spring lever on the hook, pushing the hook back into the seat bight, and rotating the hook to the side. Then pull the hook out of the vehicle seat bight.

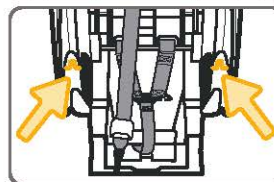

UAS Belt Storage Location

To Store UAS Belt:

When using vehicle belts, using the booster seat mode, or when the car seat is not installed in a vehicle, the UAS belt must be properly stored in its storage location.

Thread UAS belt through rear-facing belt path then attach connectors or hooks to storage attachments as shown.

Gently tighten to remove slack.

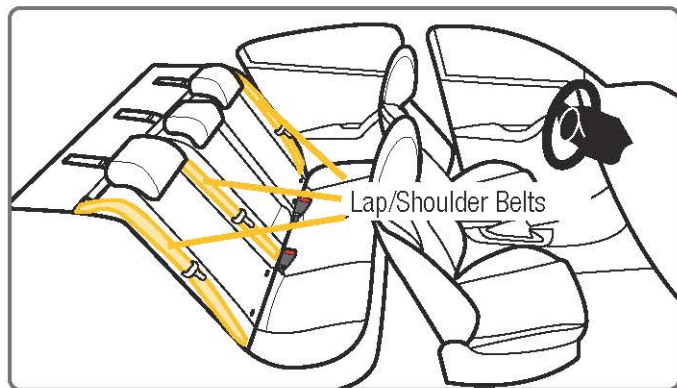

Your vehicle's features may be considerably different than those pictured here.

If UAS anchors are not an option or if your child weighs more than 18 kg (40 lb), you must use the vehicle seat belt system to install the child restraint.

Not all vehicle belts and seating positions will work with child restraints.

Please go through the following steps to understand how to lock a child restraint in **Rear-Facing** or **Forward-Facing** mode with a vehicle belt.



1



You **MUST** Review Your Vehicle Owner's Manual

Your vehicle owner's manual will let you know which vehicle belts and seating positions child restraints can be installed in.

2



Determine How the Child Restraint Will Be Locked Into Place

The vehicle belt **must not** loosen after tightening. This means there needs to be a way to lock the vehicle belt.

The ways this can be done are:

- By using the seat belt's retractor (see step 3); **OR**
- By using the seat belt's latch plate (see step 4).

3



Check the Retractor

Retractors pull seat belts into stored positions and lock the belt to hold passengers in place.

See the next page for some common types of vehicle belt retractors that will work with this child restraint.

continued on next page



Types of Retractors

Switchable Retractor (most vehicles have this type)



This retractor can be switched to a locking mode.

You **must have the retractor in the locking mode** to use the seat belt with this child restraint.

Switching to locking mode: Slowly pull the shoulder belt all the way out, then let it go back in an inch or two.

As it goes back in, you will most likely hear a ratcheting sound.

Gently pull the belt to see if it has locked. You will not be able to pull any more belt out if the lock has engaged.

Automatic Locking Retractor



This retractor always locks.

It will automatically lock after slowly pulling the seat belt out at least halfway and letting the belt go back into the retractor an inch or two.

Emergency Locking Retractor

See Step 4, “Check the Latch Plates”.

If the retractor does not lock, it is most likely an Emergency Locking Retractor. These retractors only lock during a sudden stop or collision.

You will need to determine if your seat belt’s latch plate can lock the belt. See Step 4, “Check the Latch Plates”.



4

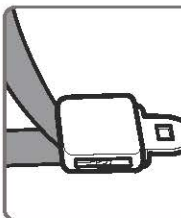

Locking Latch Plate

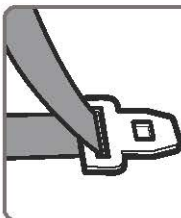

Emergency Locking Retractor with a Sliding Latch Plate

Check the Latch Plates

Latch plates are the part of the seat belt that goes into the buckle.

To see if the latch plate locks: Buckle the vehicle belt.

Then firmly tug the lap portion of the seat belt while pulling it up.

If the vehicle belt does not slide through the latch plate, it’s locked.

If the latch plate slides up and down the vehicle belt, it is a **sliding latch plate**.

Sliding latch plates easily slip between the lap and shoulder portions of the belt.

If you have an Emergency Locking Retractor with a Sliding Latch Plate, you must use a locking clip.

Please contact us for one.

See pages 77-78.

Never Use With This Child Restraint

Emergency Locking Retractor Lap Only Belt



Inflatable Seat Belts





For Forward-Facing Mode Only

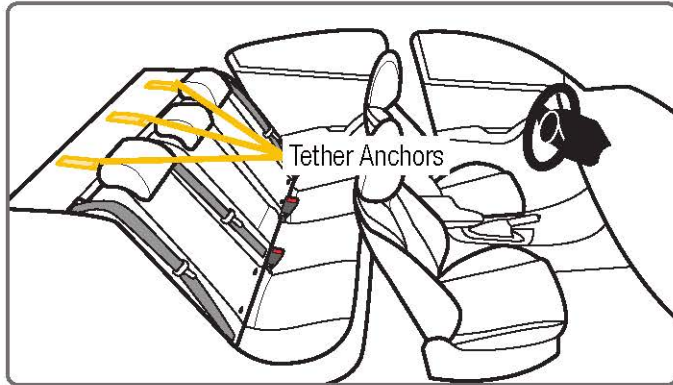

Your vehicle's features may be considerably different than those pictured here.

You **must always attach, adjust, and secure the top anchorage (tether) strap** when installing the child restraint forward-facing with internal harness. Tethers improve the installation and stability of child restraints and reduce the risk of injury.

Attach the tether hook to the tether anchor designated by your vehicle manufacturer for that seating position. Check your vehicle owner's manual for more information.

If the seating position does not have a tether anchor, use a different seating position or see your dealer or a qualified mechanic and have one installed.



Using this child restraint without the tether strap anchored as recommended by the manufacturer would be a misuse of the child restraint and, in a sudden stop or crash, could result in serious injury or death.

Do not fasten multiple tether hooks on the same tether anchor in the vehicle.



Storing Tether Strap

When installing rear-facing, using the booster seat mode, or when the car seat is not installed in a vehicle, attach the tether hook to its storage attachment on back of car seat as shown.

Gently tighten to remove slack.

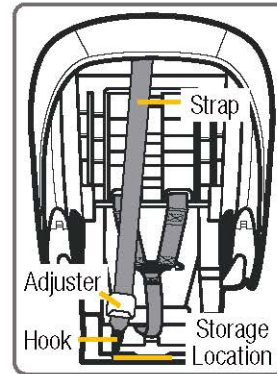

Tether Storage and Parts

Pull free end of belt to tighten

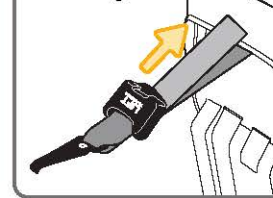

Lift adjuster up to loosen



Adjusting Tether Strap

To tighten: After the child restraint is locked into place with the lower anchor/UAS belt or vehicle belt, push down on child restraint and gently pull on free end of tether strap.

To loosen: Lift up on tether adjuster and push it towards tether hook.



Rear-Facing Mode

2.3-18 kg (5-40 lb) and
48-102 cm (19-40 in.)

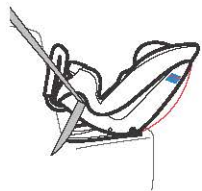
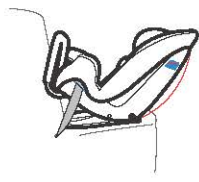
Lap/Shoulder
Belt

Lap Belt

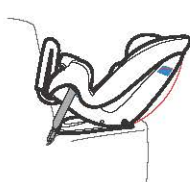

UAS Belt



Never install a rear-facing child restraint in the front seat of a vehicle equipped with an active frontal airbag.

Do not use the tether for rear-facing mode. Secure tether strap to its storage location.

Do not use the UAS belt along with the vehicle lap or lap/shoulder belt.

Check the vehicle belt or the UAS belt before each use. Use only if the belt can be tightened properly and locked securely in place.

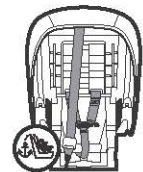

Do not fasten multiple UAS connectors or hooks on the same lower/UAS anchor bar in the vehicle.

The anti-rebound bar must be used in rear-facing mode.

Even when unoccupied, this child restraint must be firmly secured to the vehicle with a UAS belt or with the vehicle seat belt.

This child restraint **MUST** always face the rear of the vehicle until the child is at least 1 year old and weighs 10 kg (22 lb).

Rear-Facing Vehicle Belt Install



Before you begin installing the seat into your vehicle, did you check:



Your child's weight and height?

See page 31.



Your child's fit? See page 10.

Do you need to make adjustments to the harness/headrest height or the buckle position?

1

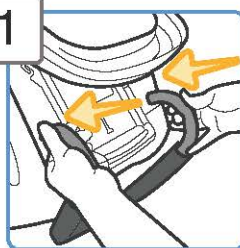

Install Anti-Rebound Bar

You must install the anti-rebound bar to use this seat in **Rear-Facing** Mode. See page 20.

2

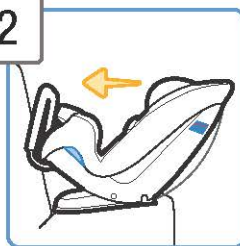

Place Car Seat Rear-Facing in Back Seat

The anti-rebound bar should make contact with the vehicle seat back, but it does not need to be flush with the vehicle seat back.



3



Recline the Car Seat

Pull out on recline handle and push top of child restraint back.

4

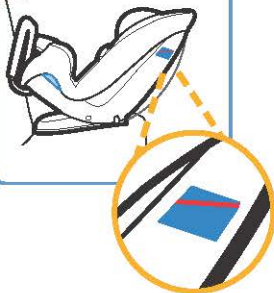

Check Rear-Facing Level Line

The level line on shell **must** be parallel with the ground using either position 3 or 2.

5

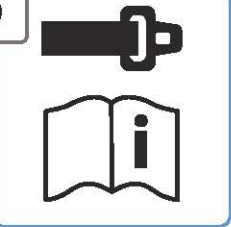

Check if Your Vehicle Belts Will Work With This Child Restraint

This is very important because **not all vehicle belts will work with child restraints.**

Review pages 25-28 and your vehicle owner's manual to determine what kind of vehicle belt you have and how to lock a child restraint in place.



6

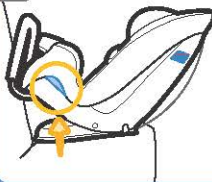

Locate Rear-Facing Belt Path

7



Route Vehicle Belt

Thread the vehicle belt into the **Rear-Facing Belt Path** opening.

Pull it across the seat, under the seat pad, in front of the buckle, and out through the other belt path opening.

Do not twist belt.

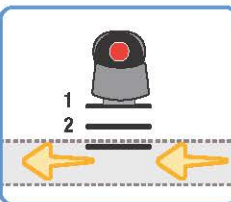

8



Buckle Vehicle Belt

If your car's vehicle belt has a switchable retractor, use it to lock the vehicle belt. For information about switchable retractors, see page 27 or review your vehicle owner's manual.



9

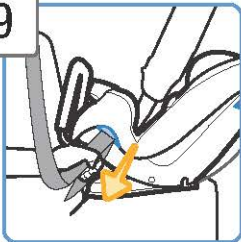

Tighten Belt

Place hand in child restraint.

Firmly push child restraint down and back towards the vehicle seat back while pulling the shoulder belt or the free end of lap belt parallel with the belt path through the belt path opening as shown.

10

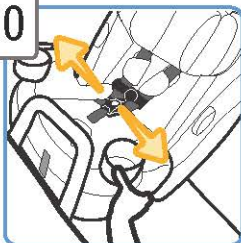

Check Belt Tightness

Hold child restraint at the belt path with your weaker hand.

Push and pull from side to side.

It should not move more than 2.5 cm (1 in.).

If it moves more than 2.5 cm (1 in.), you can try:

- A. Pulling the belt tighter.
- B. Reinstalling the child restraint.
- C. Changing to a different seating location.
- D. Switching to UAS belt installation if UAS anchors are available in your vehicle.

11



Secure Child in Car Seat

To properly secure your child in the car seat, see pages 52-54.

Check your child's fit often and make any needed adjustments to the car seat as they grow.



12

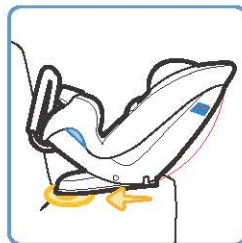
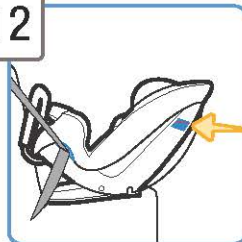

Recheck Rear-Facing Level Line

Redo the installation if the level line is not parallel with the ground.

NOTE: Only if necessary, you may place a tightly rolled towel(s) or foam pool noodle(s) under the front of the base to help achieve the correct recline.

Check often to be sure padding is still in place and the belt is tight.

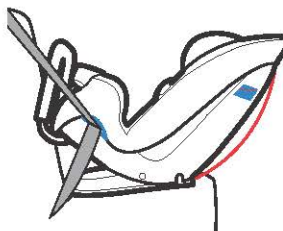

Finished!

Check the tightness of the install often to make sure it has not loosened.



Before you begin installing the seat into your vehicle, did you check:



Your child's weight and height?
See page 31.



Your child's fit? See page 10.
Do you need to make adjustments to the harness/headrest height or the buckle position?

1



Install Anti-Rebound Bar

You **must** install the anti-rebound bar to use this seat in **Rear-Facing** Mode. See page 20.

2

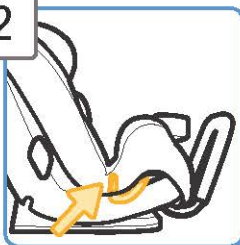

Remove UAS Belt from Storage Location

Or if the UAS belt was used **Forward-Facing**, remove it from the Forward-Facing belt path so both connectors or both hooks are on the same side of the seat.

3

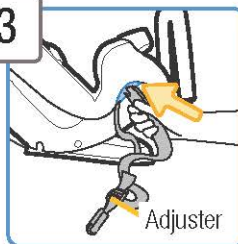

Locate Rear-Facing Belt Path

Thread the connector or hook without the adjuster closest to it through the **Rear-Facing Belt Path** opening as shown.

4

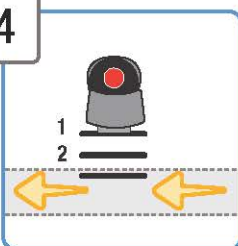

Pull UAS Belt Across the Seat

It must be under the seat pad, in front of the buckle, and go out through the other belt path opening.

Do not twist belt.

5

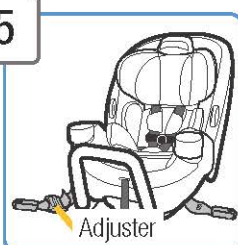

Finished UAS Belt Routing

6

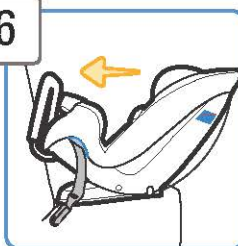

Place Car Seat Rear-Facing in Back Seat

The anti-rebound bar should make contact with the vehicle seat back, but it does not need to be flush with the vehicle seat back.

continued on next page





7



Recline the Car Seat

Pull out on recline handle and push top of child restraint back.

8

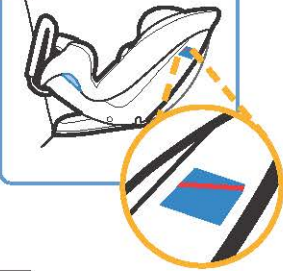

Check Rear-Facing Level Line

The level line on shell must be parallel with the ground using either position 3 or 2.

9



Depending on Your Model: Attach UAS Connectors or Hooks to Vehicle's UAS Anchors in Seat Bight

Review your vehicle owner's manual for UAS anchor locations and UAS belt use.

Fasten one connector or hook to one vehicle UAS anchor bar.

Then repeat for the second connector or hook on the other side of the car seat.

For UAS Connectors: Make sure arrows on connectors are facing up.

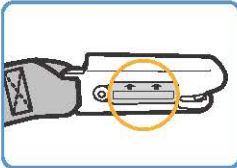
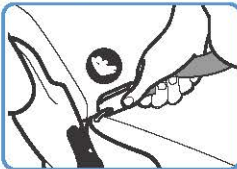

10

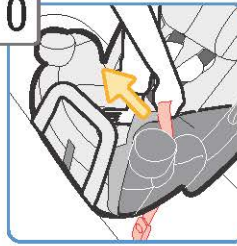

Tighten Belt

Place hand in child restraint. Firmly push child restraint down and towards the vehicle seat back while pulling the free end of the belt parallel with the belt path through the belt path opening as shown.

11

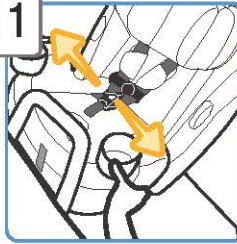

Check Belt Tightness

Hold child restraint at the belt path with your weaker hand. Push and pull from side to side. It should not move more than 2.5 cm (1 in.).

If it moves more than 2.5 cm (1 in.), you can try:

- Pulling the belt tighter.
- Reinstalling the child restraint.
- Changing to a different seating location.
- Switching to vehicle belt installation.

12



Secure Child in Car Seat

To properly secure your child in the car seat, see pages 52-54.

Check your child's fit often and make any needed adjustments to the car seat as they grow.



13

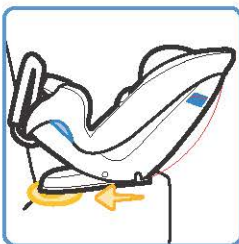

Recheck Rear-Facing Level Line

Redo the installation if the level line is not parallel with the ground.

NOTE: Only if necessary, you may place a tightly rolled towel(s) or foam pool noodle(s) under the front of the base to help achieve the correct recline.

Check often to be sure padding is still in place and the belt is tight.

Finished!

Check the tightness of the install often to make sure it has not loosened.

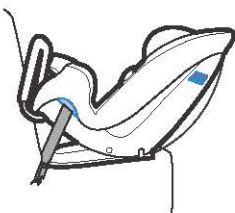

10-30 kg (22-65 lb) and 74-125 cm (29-49 in.)
and at least 1 year old

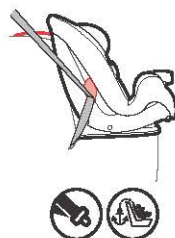

Lap/Shoulder Belt and Tether

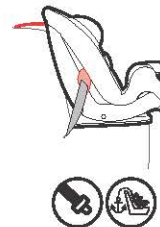

Lap Belt and Tether

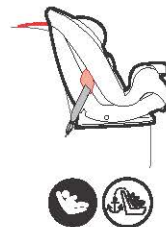

UAS Belt and Tether
Do not install by this method for a child weighing more than 18 kg (40 lb).



Do not use the UAS anchors of the child restraint anchorage system (UAS) to attach this child restraint when restraining a child weighing more than 18 kg (40 lb).

The vehicle belt must be used for installation if your child weighs more than 18 kg (40 lb).

Do not use the UAS belt along with the vehicle lap or lap/shoulder belt.

Check the vehicle belt or the UAS belt before each use. Use only if the belt can be tightened properly and locked securely in place.

Do not fasten multiple UAS connectors or hooks on the same UAS anchor bar in the vehicle.

In forward-facing mode, you must remove the anti-rebound bar.

Even when unoccupied, this child restraint must be firmly secured to the vehicle with a UAS belt or with the vehicle seat belt.

In this child restraint your child **MUST** be at least 1 year old and weigh 10 kg (22 lb) before they sit forward-facing.



Forward-Facing Vehicle Belt + Tether Install

Before you begin installing the seat into your vehicle, did you check:



Your child's weight and height?

See page 42.



Your child's fit? See page 11.

Do you need to make adjustments to the harness/headrest height or the buckle position?

1

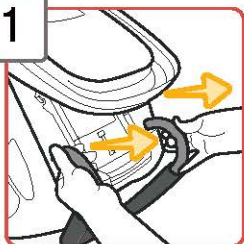

Remove Anti-Rebound Bar

You **must** remove the anti-rebound bar to use this seat in **Forward-Facing** Mode. See pages 21-22.

2

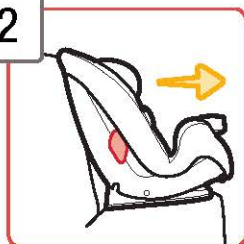

Place Car Seat Forward-Facing in Back Seat



3



Make Car Seat Flush Against Vehicle Seat

Put the child restraint into Position 1.

Only use the semi-reclined position if necessary to install the child restraint flush against the vehicle seat back.

Vehicle seat back must be upright.

NOTE: If your vehicle seat has a headrest that interferes with achieving a flush car seat fit, check your vehicle owner's manual to see if it can be removed, adjusted, or if there are other possible seating locations.

4



Loosely Attach Tether Hook to Vehicle's Tether Anchor

Check vehicle owner's manual for specific location.

5

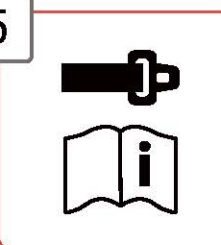

Check if Your Vehicle Belts Will Work With This Child Restraint

This is very important because **not all vehicle belts will work with child restraints.**

Review pages 25-28 and your vehicle owner's manual to determine what kind of vehicle belt you have and how to lock a

child restraint in place.



6



Route Vehicle Belt

Thread the vehicle belt through **Forward-Facing Belt Path** opening.

Pull it across the seat. Then thread it through the other belt path opening.

Do not twist belt.

7

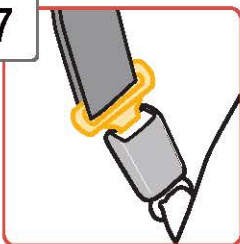

Buckle the Vehicle Belt

If your car's vehicle belt has a switchable retractor, use it to lock the vehicle belt.

For information about switchable retractors, see page 27 or review your vehicle owner's manual.

8

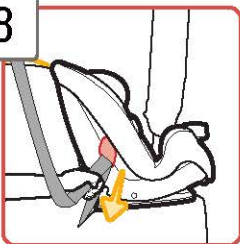

Tighten Belt

Place hand in child restraint.

Firmly push child restraint down while pulling the shoulder belt or free end of the lap belt parallel with the belt path through the belt path opening as shown.

9



Tighten Tether

Push firmly on the back of the seat and pull the tether strap to remove all slack and create tension on the strap.



10

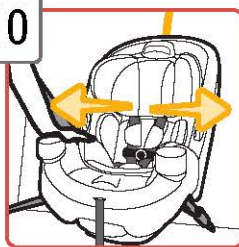

Check Belt Tightness

Hold child restraint at the belt path with your weaker hand. Push and pull from side to side. It should not move more than **2.5 cm (1 in.)**.

If it moves more than 2.5 cm (1 in.), you can try:

- A. Putting your knee in the seat and pulling the belt tighter.
- B. Reinstalling the child restraint.
- C. Changing to a different seating location.
- D. Switching to the UAS belt installation if UAS anchors are available in your vehicle.

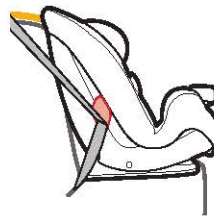

Finished!

Check the tightness of the install often to make sure it has not loosened.



Securing Child in Car Seat

To properly secure your child in the car seat, see pages 52-54.

Check your child's fit often and make any needed adjustments to the car seat as they grow.



Forward-Facing UAS + Tether Install

Do not use the UAS anchors of the child restraint anchorage system (UAS) to attach this child restraint when restraining a child weighing more than 18 kg (40 lb).

Before you begin installing the seat into your vehicle, did you check:



Your child's weight and height?

See page 42.



Your child's fit? See page 11.

Do you need to make adjustments to the harness/headrest height or the buckle position?

1

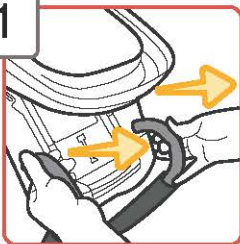

Remove Anti-Rebound Bar

You **must** remove the anti-rebound bar to use this seat in **Forward-Facing** Mode. See pages 21-22.

2

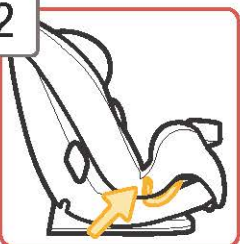

Remove UAS Belt from Storage Location

Remove it from the rear-facing belt path so both connectors or both hooks are on the same side of the seat.

3

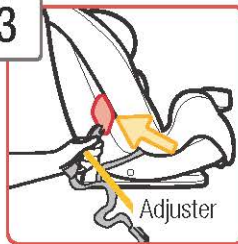

Route the Connector or Hook with the Adjuster Closest to it Through the Forward-Facing Belt Path As Shown

Pull it across the seat. Then thread it through the other belt path opening.

Do not twist belt.

4

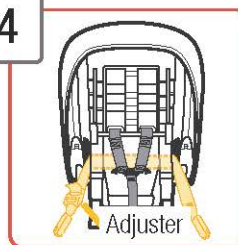

Finished UAS Belt Routing

5



Place Car Seat Forward-Facing in Back Seat





6

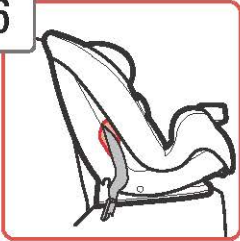

Make Car Seat Flush Against Vehicle Seat

Put the child restraint into Position 1.

Only use the semi-reclined position if necessary to install the child restraint flush against the vehicle seat back.

Vehicle seat back must be upright.

NOTE: If your vehicle seat has a headrest that interferes with achieving a flush car seat fit, check your vehicle owner's manual to see if it can be removed, adjusted, or if there are other possible seating locations.

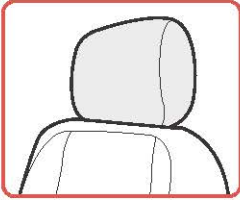

7

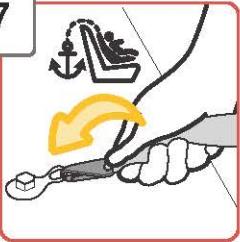

Loosely Attach Tether Hook to Vehicle's Tether Anchor

Check vehicle owner's manual for specific location.



8

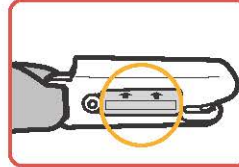
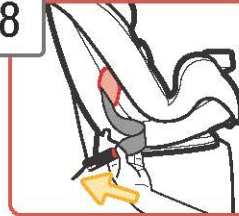

Depending on Your Model: Attach UAS Connectors or Hooks to Vehicle's UAS Anchors in Seat Bight

Review your vehicle owner's manual for UAS anchor locations and UAS belt use.

Fasten one connector or hook to one vehicle UAS anchor bar.

Then repeat for the second connector or hook on the other side of the car seat.

For UAS Connectors: Make sure arrows on connectors are facing up.

9

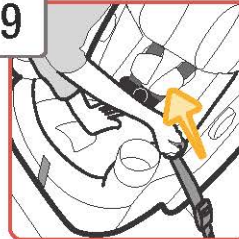

Tighten Belt

Place hand in child restraint.

Firmly push child restraint down while pulling the free end of the belt parallel with the belt path through the belt path opening as shown.



10

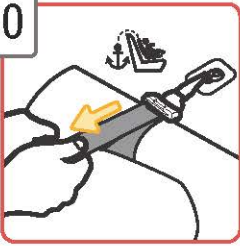

Tighten Tether

Push firmly on the back of the seat and pull the tether strap to remove all slack and create tension on the strap.

11

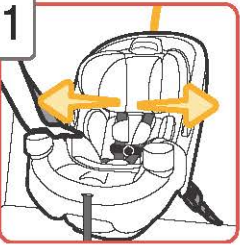

Check Belt Tightness

Hold child restraint at the belt path with your weaker hand. Push and pull from side to side. It should not move more than 2.5 cm (1 in.).

If it moves more than 2.5 cm

(1 in.), you can try: A. Putting your knee in the seat and pulling the belt tighter. B. Reinstalling the child restraint. C. Changing to a different seating location. D. Switching to vehicle belt installation.

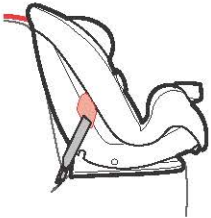

Finished!

Check the tightness of the install often to make sure it has not loosened.



Securing Child in Car Seat

To properly secure your child in the car seat, see pages 52-54.

Check your child's fit often and make any needed adjustments to the car seat as they grow.

1

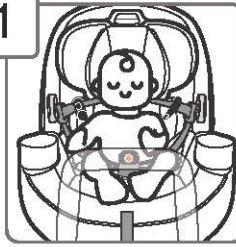

Place Child in Car Seat

The child's bottom and back should be flat against the car seat. Position harness straps over your child's shoulders and upper thighs.

2

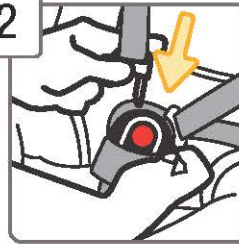

Buckle Harness

Push buckle tongues into buckle until you hear them "click". Pull up on harness straps to make sure buckle is locked.

3

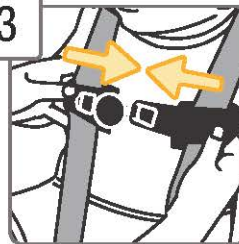

Fasten Chest Clip

Insert right half of chest clip into left half and snap together.

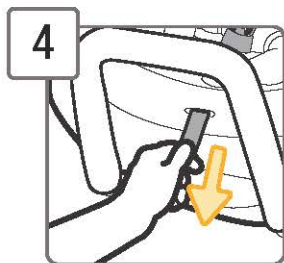

4

Tighten Harness

Pull on harness adjustment strap to snugly tighten harness.

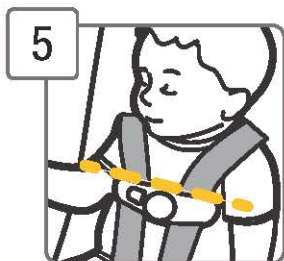

5

Position Chest Clip

Slide chest clip up the harness straps and position it at mid-chest (even with armpits) and away from the child's neck.

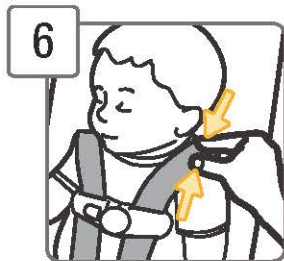

6

Check Harness Tightness

Try to pinch the harness at the shoulders and hips vertically between index finger and thumb as shown.

If your fingers slip off, the harness is tight enough.

If you can pinch the harness strap, tighten more.

A snug strap should not allow any slack. It lies in a relatively straight line without sagging. It does not press on the child's flesh or push the child's body into an unnatural position.



Rear-Facing



Forward-Facing

Finished!

The child is now secured in the car seat.

Check your child's fit often and make any needed adjustments to the car seat as they grow.

To Remove Child from Car Seat:

1. Loosen Harness Strap
2. Unbuckle Harness
3. Release Chest Clip
4. Remove Child



Failure to fasten and tighten the harness system correctly may allow the child to be ejected from the child restraint in a crash or sudden stop causing serious injury or death.



Do not mistake comfort for safety. Harness system must be snugly adjusted.

Do not put snowsuits or bulky garments on your child when placing them in the child restraint. Bulky clothing can prevent the harness straps from being tightened properly.



18-45 kg (40-100 lb) and 110-132 cm (43-52 in.)

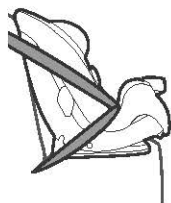

Lap/Shoulder Belt

Keep the booster seat securely belted even when unoccupied.



Do not use the harness system when using as a booster seat.



Use only the vehicle's lap and shoulder belt system when restraining the child in this booster seat. Do not use only the lap belt when using this seat as a booster seat.

The shoulder belt must always be adjusted snugly across the child's chest. NEVER place shoulder belt under the child's arms or behind their back.

Do not use this booster seat if the tops of your child's ears are above the top of the booster seat's headrest.

Do not use the UAS when using as a booster seat. Secure UAS belt and tether strap to their storage locations.

In booster seat mode, you must remove the anti-rebound bar.

You must store the harness system and remove accessories when using the Booster Seat mode. To remove accessories, see pages 3-5.

⚠ Do not fully pull the harness strap out of the car seat. Leave it threaded in the hip harness slots. If removed, you will not be able to rethread it.

1

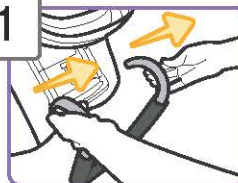

Remove Anti-Rebound Bar

You **must** remove the Anti-Rebound bar to use this seat in **Booster Seat Mode**.

See pages 21-22.

2

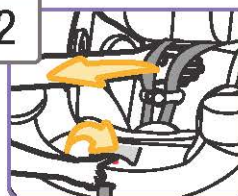

Fully Loosen Harness Straps

Push down on harness release lever (through opening in pad) while pulling out on harness straps as shown.

3



Unbuckle Harness

Press in towards the **top** of the red buckle button to release the buckle tongues.

4



Locate Buckle's Metal Retainer

Fully recline the child restraint and reach under the seat between the base and shell and through the recline handle.

Rotate metal retainer and push it up through shell and pad.

continued on next page

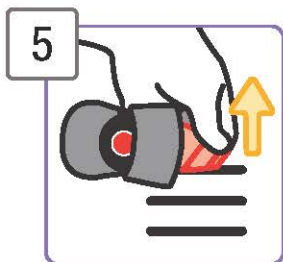

5

**From Top of Seat,
Pull Buckle Out of Shell
and Pad**

Store the buckle in a safe place
for future use.

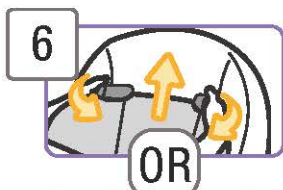

6

**Adjust Headrest to
Highest Position**

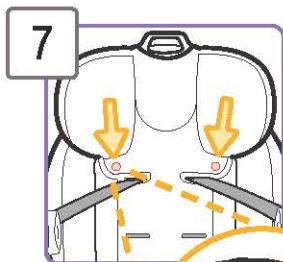

7

**Undo Fasteners on
Headrest Pad As Shown**

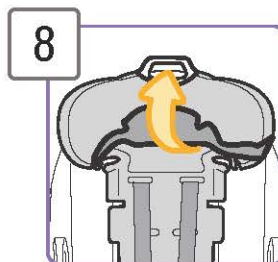
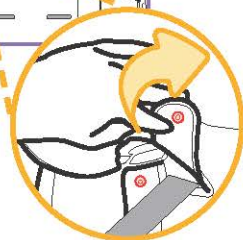

8

**Pull Headrest Pad Off
Bottom of Headrest
As Shown**

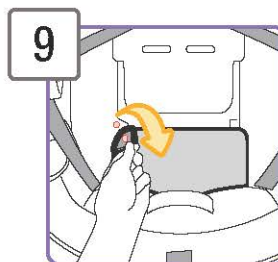

9

**Undo Fasteners on Seat
Pad As Shown**

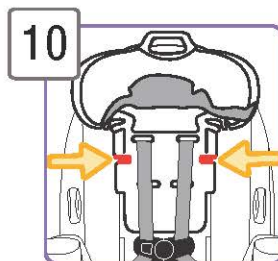

10

**Thread Harness Straps
into Slots on Sides of
Headrest As Shown**

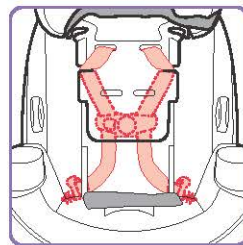

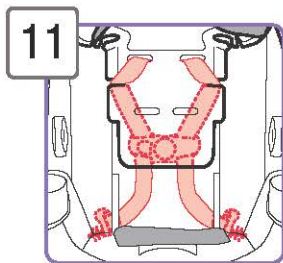

11 Place Chest Clip, Harness Straps, and Buckle Tongues Behind the Headrest and Seat Pad As Shown

Push chest clip up so it is behind the headrest.

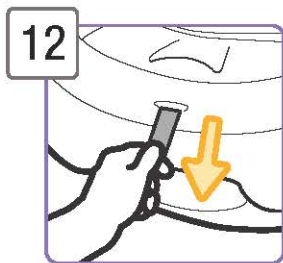

12 Tighten Harness

Pull on harness adjustment strap to remove any slack from the harness system.

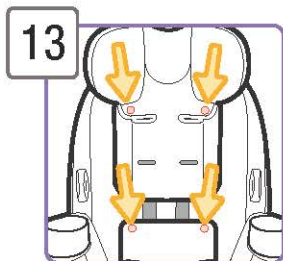

13 Pull Headrest Pad Down and Wrap Around Bottom of Headrest

Attach fasteners on seat pad.

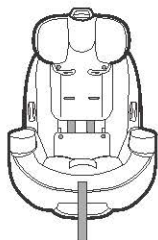

Finished!

The car seat has been converted to **Booster Seat Mode**.

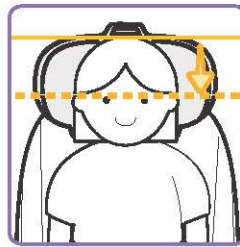

Head Position

Tops of the child's ears should never be above the top of the headrest.

Adjust headrest if needed, see page 12.

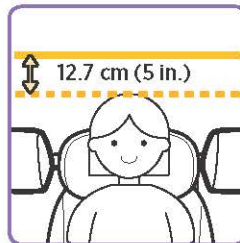

Car Position

DO NOT use the booster seat if your child's head is less than 5 in. (12.7 cm) below the roof of the car.

Consult your vehicle manual for proper seatbelt usage.



Shoulder Belt Position

The shoulder belt should lay snugly across the center of the child's shoulder and across the chest and not on their face or neck.

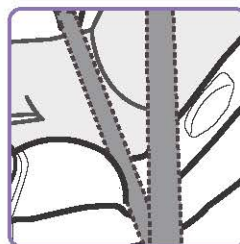

Lap Belt Position

The lap belt should lay snugly across the child's hips and not on their stomach.



You must store the harness system when using the **Booster Seat mode**. See pages 56-59.

1

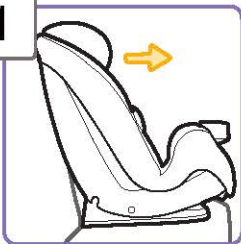

Place Booster Seat Forward-Facing in Back Seat

Put the booster seat into Position 1.

Only use the semi-reclined position if necessary to install the booster seat flush against the vehicle seat back.

Vehicle seat back must be upright.

NOTE: If your vehicle seat has a headrest that interferes with achieving a flush car seat fit, check your vehicle owner's manual to see if it can be removed, adjusted, or if there are other possible seating locations.

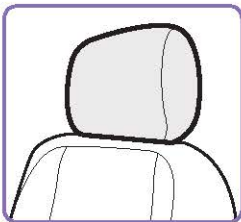

2



Have Child Sit in Booster Seat

3

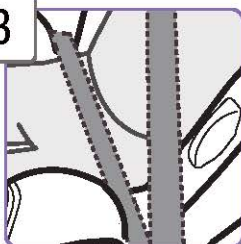

Position Lap Belt on Child

Route the lap belt portion of vehicle belt through the booster belt path as shown.

The lap belt should lay snugly across the child's hips and not on the stomach.



4

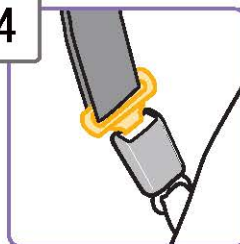

Buckle the Vehicle Belt

Pull up on lap belt to tighten.

5

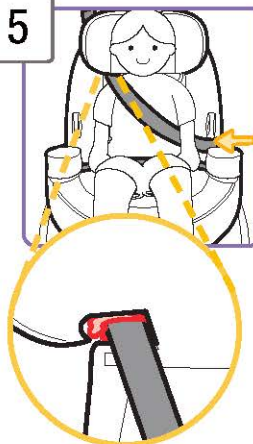

Position Shoulder Belt on Child

Thread the shoulder belt through the belt-positioning guide in the headrest.

Pull the shoulder belt up to tighten so that it lies snugly across the center of your child's shoulder and across their chest.

For models with In and Out Harness Holders: The shoulder belt should lay under the In and Out Harness Holder.

For models without In and Out Harness Holders: The shoulder belt will fall naturally into place.



Finished!

Check periodically to make sure your child has not moved out of position and loosened the shoulder belt.

Removing Seat Pad Set for Cleaning

You DO NOT need to remove the harness system to remove the pad from the shell. To remove accessories, see pages 3-5.

1

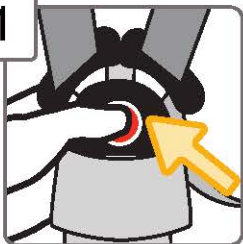

Unbuckle Harness

Press in towards the top of the red button.

Pull buckle tongues out.

2



OR



Adjust Headrest to Highest Position

3

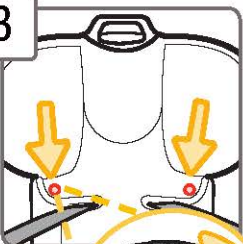

Undo Fasteners on Headrest Pad As Shown

4

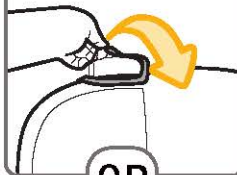

OR



Headrest Style 1: Pull Elastic Straps on Headrest Pad Over Headrest/Harness Adjustment Levers As Shown

Headrest Style 2: Locate Pad Fabric Tab Slot in Headrest

There is one at the headrest/harness adjustment handle.

Pull the fabric tab out of the slot in the headrest as shown.

5

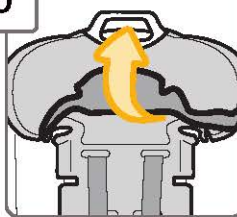

Pull Headrest Pad Off Bottom of Headrest As Shown

Remove headrest pad from shell.

6

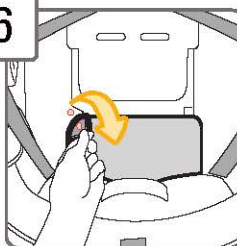

Undo Fasteners on Seat Pad As Shown

continued on next page

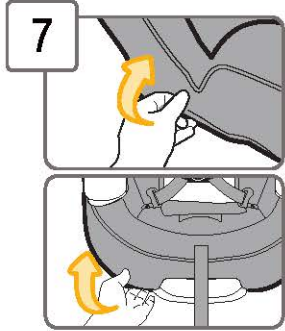

7 Pull Pad Off Sides and Bottom of Shell

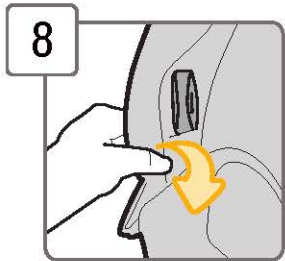

8 Pull Pad Down and Off of Bottom of Harness Holders

Pull up to remove completely.

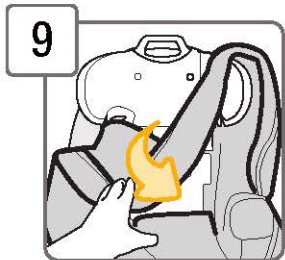

9 From Top of Seat, Pull Pad Off of Shell

Cleaning Pad and Accessories

Machine wash separately with cold water on a gentle cycle. Make sure the harness covers are closed so the fastening strips are not exposed. Do not use bleach. Tumble dry separately for 10-12 minutes on low heat. Remove immediately.

Cleaning Harness Strap

Check the harness straps often for any wear or damage.

⚠ Do not fully pull the harness strap out of the car seat. Leave it threaded in the hip harness slots. If removed, you will not be able to rethread it.

Spot clean using warm sudsy water and damp cloth. Spilled food and liquids on the car seat may result in mold or bacterial growth over time. These spills could also attract insects or rodents.

Cleaning Buckle & Car Seat Shell

Spot clean using warm sudsy water and damp cloth. Do not submerge into water.

⚠ Do not use the child restraint without the seat pad or with damaged harness straps.



Adjust Headrest to Highest Position

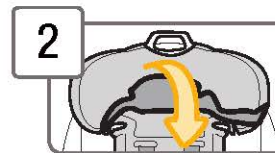

Gently Pull Headrest Pad onto Headrest



Headrest Style 1: Place Elastic Straps on Headrest Pad Around Headrest/Harness Adjustment Levers
Headrest Style 2: Locate Pad Fabric Tab Slot in Headrest

There is one at the headrest/harness adjustment handle.

Slide the fabric tab into the slot in headrest as shown.

continued on next page

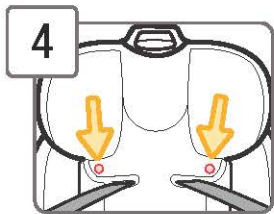

Slide Harness Straps into Slots in Pad and Attach Fasteners

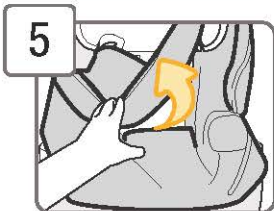

Starting at Top of Seat, Slip Pad on Shell

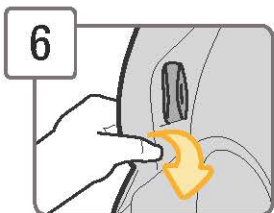

Push Harness Holders Through Slots in Pad

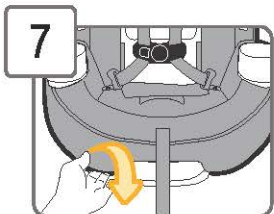

Wrap Around Bottom and Sides of Shell
Pull harness adjustment strap through slot in pad.

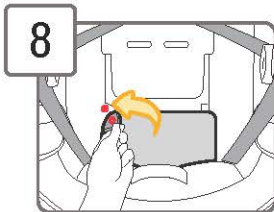

Attach Fasteners

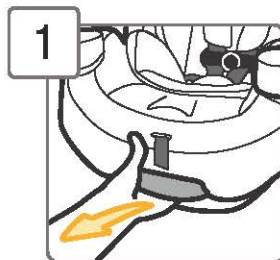

Fully Recline the Child Restraint
Pull out on recline handle and push top of child restraint back.

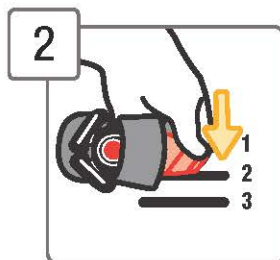

Insert Buckle's Metal Retainer into Slot Closest to Child

Buckle **must** face out.
Rear-Facing Mode: You **must** use the 1st or 2nd buckle slots.
Forward-Facing Mode: Any slot can be used.



Reach Under Seat Between Base and Shell and Through Recline Handle
Pull metal retainer completely through pad and shell.

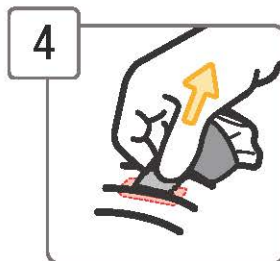

Check Buckle

Pull up on buckle to make sure it is secured.
The buckle **must** not pull out.

5 Adjust Headrest to Highest Position

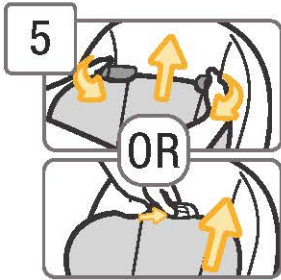

6 Undo Fasteners on Seat Pad and Pull Headrest Pad Off Bottom of Headrest

Unthread harness straps from slots on side of headrest.

Loosen harness straps.

Pull chest clip, harness straps, and buckle tongues out from behind the headrest and seat pad.

Slide harness straps into slots in headrest pad.

Attach seat pad fasteners.



If you have removed the harness straps from the splitter plate, and the buckle tongues and chest clip have been unthreaded from the harness straps, follow the steps below to rethread them.

1 Thread Buckle and Chest Clip

Harness strap ends go through the back of buckle tongues and through the chest clip front to back as shown.

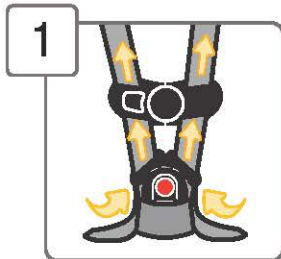

2 Thread Harness Straps into Upper Shoulder Harness Slots

If you will be using the lower shoulder harness slots for smaller children, see pages 15-18.

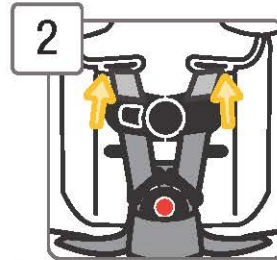

3 From Back, Thread Harness Straps OVER Metal Bar

Do not twist harness straps.

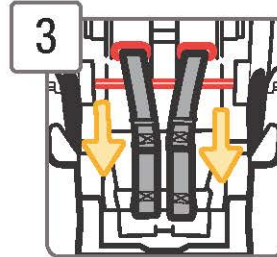

4 Attach 1st Harness Strap Loops to Splitter Plate As Shown

Sewn ends of the harness strap loops **must** face towards you.

Do not twist harness strap or harness adjustment strap.

Make sure the same harness strap loops are fitted **completely** on both sides of the splitter plate.

If you cannot achieve a snug harness fit for your child, see pages 15-18. To learn how to check harness tightness, see pages 52-54.

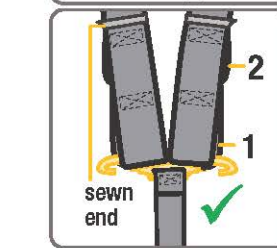
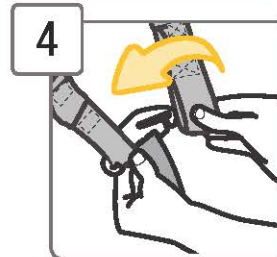

⚠ The harness system must be installed correctly. Do not use a child restraint with damaged harness straps.



This restraint is certified for aircraft use when used with the internal harness.

This child restraint is not certified for aircraft use when used as a booster seat because aircraft seats do not have shoulder belts.

Install the child restraint in a window seat to avoid blocking the aisle. If the aircraft lap belt is too short, ask the flight attendant for a belt extender.

Use only on forward-facing aircraft seats.

Contact the airline for their specific policies.

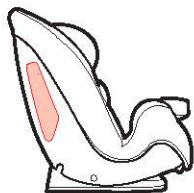

Some airlines may ask to see a label stating that this child restraint is certified for aircraft use.

There is an airplane certification label located on the side of this child restraint as shown.

⚠ Store UAS belt, tether strap, and anti-rebound bar when installing with aircraft belts.

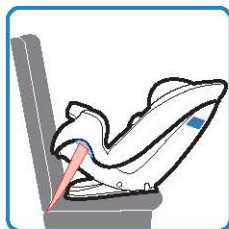

Rear-Facing Aircraft Installation

Follow pages 32-36, skipping the anti-rebound bar installation steps.



Forward-Facing Aircraft Installation

Follow pages 43-46, skipping the tether strap steps.



Do not risk your child's safety.

To keep your child as safe as possible, Dorel Juvenile Group strongly recommends replacing the car seat even after a minor crash; even if it was not occupied at the time.

Replacement After a Minor Crash

The National Highway Traffic Safety Administration states that for a crash to be considered minor **ALL of the following must be true:**

- Vehicle able to drive away from the crash site; **AND**
- Vehicle door nearest the car seat was not damaged; **AND**
- No passengers were injured; **AND**
- Airbags did not deploy; **AND**
- There is no visible damage to the car seat.

If the crash your car seat was involved in meets **ALL** the criteria, you may not need to replace the car seat.

If one or more of these criteria are not true or if you are uncertain of any of your answers, replace the car seat immediately.

Replacement After a Moderate to Severe Crash

You **must** replace this car seat if it has been in a moderate to severe car crash.

This car seat is intended to protect a child in a single crash. During a crash, the car seat and all of its parts absorb crash energy which can deform or weaken it. Damage is not always visible. A damaged car seat must be replaced immediately.

Expiration



On the side of the child restraint there is a date of manufacture label as shown.

Do not use this child restraint more than 10 years after the date of manufacture.



Child Restraint Use

Never take your child out of the child restraint while the vehicle is moving.

Never leave child unattended. Placing your child in a hot child restraint may result in burns.

Do not use a child restraint with damaged or missing parts.

Do not use cut, frayed or damaged harnesses.

Do not substitute parts or try to modify the child restraint in any way. Do not lubricate buckles and fasteners.

Do not use any child restraint accessory except those approved by Dorel Juvenile Group.

Never allow any child to play with this child restraint; it is not a toy.

Do not remove or cover up any of the warning labels or other labels on the child restraint.

This child restraint has been certified for use in passenger vehicles. Do not use in a boat, on a motorcycle or in a cargo van or bus where there are no seat belts or tether anchors.

Read all instructions for additional warnings.

Installation in Vehicle

Check the vehicle belt or UAS belt before each use. Use only if the belt is tightened properly and locked securely in place.

Even when unoccupied, this child restraint must be firmly secured to the vehicle with a UAS belt or with the vehicle seat belt.

Even when unoccupied, this booster seat must be firmly secured to the vehicle with the vehicle seat belt.

In a crash or sudden stop, an unsecured child restraint or booster seat could injure occupants.

Transport Canada Regulations

Transport Canada Road Safety Directorate regulates children's restraint systems under the Motor Vehicle Restraint Systems Safety Regulations (RSSR).

The regulations require the manufacturer and/or importer to certify the restraint to the applicable safety standards and place specified warnings and information on the labels fastened to each restraint and in this instruction manual.



Vehicle Seating Position



Never place a child rear-facing in a seating position with an active frontal air bag.

Check the vehicle owner's manual for more information about air bag/child restraint use.



Use the child restraint only on vehicle seats that face forward.



Do not use on seats that face the sides or rear of the vehicle.

For vehicles without a back seat, refer to your vehicle owner's manual.



Children are safer when properly restrained in rear seating positions than in the front seating positions.

According to accident statistics, children in rear seating positions are statistically safer, whether you have air bags, advanced air bags, or no air bags at all.

If you are not sure where to place the child restraint in your vehicle: consult your vehicle owner's manual or contact Dorel Juvenile Group Consumer Care Department.

To avoid your child being seriously burned, take the following precautions:

1. Park in the shade or where sun does not directly hit the child restraint.
2. Cover the child restraint with a sheet or blanket when not in use.
3. Check for hot seat and buckles before placing child in child restraint.

To help protect your vehicle seat's upholstery from damage, use a single layer towel underneath and behind child restraint.



Although child restraints are tested, evaluated, and certified by the manufacturer and tested by Transport Canada, it is possible that a safety-related problem may be found. If there is ever a safety issue with your child restraint, we use registration information to reach owners.

Comments: Just fill in your name, address and email. Please print.
 Client: S'implémentez l'inscrire votre nom, adresse et courriel. S.V.P. Imprimez.

Your Name/Votre nom: _____

Your Street Address/Votre adresse: _____

City/Ville: _____ Province _____ Postal Code/Code Postal: _____

Email Address (optional)/Courriel (optionnel): _____

AB123CDE SF CARSEAT 2015/05/16

Date of Purchase/Date d'achat: _____ L#11 B265035

Example of model number, manufacture date, and line code.



If you don't have the card or if your address changes, you will find the model number, manufacture date, and line code on the label located on the side of the shell.

There are three additional ways to register your information:

Online: www.djgusa.com/registration/carseat/can

Telephone: 1-800-544-1108

Mail: Send your name, address and your child restraint's model number, manufacture date, line code, and date of purchase to:

Dorel Juvenile Canada
 2233 Argentia Road, Suite 110
 Mississauga, ON L5N 2X7

Please do not send in your registration card if you have registered your child restraint online. For information on safety-related problems, you can also call Transport Canada's Road Safety Dept. at: 1-800-333-0371.

Dorel Juvenile Group, Inc. (DJG) warrants this product to the original retail purchaser as follows:

This product is warranted against defective materials or workmanship for one year from the date of original purchase. **An original receipt is required to validate your warranty.** DJG will, at its option, provide replacement parts or replace this product. DJG reserves the right to substitute if the part or model has been discontinued.

To make a claim under this warranty, please contact our Consumer Care Department by phone: 1-800-544-1108; text: 1-812-652-2525; or chat with us: www.safety1st.com.

Our hours of operation are from 8:00 a.m. to 6:00 p.m. EST Monday through Thursday and from 8:00 a.m. to 4:30 p.m. on Friday.

Proof of purchase is required and shipping charges are the responsibility of the consumer.

Warranty Limitations: This warranty does not include damages which arise from misuse or abuse of this product.

Limitation of Damages: The warranty and remedies as set forth are exclusive and in lieu of all others, oral or written, expressed or implied. In no event will DJG or the dealer selling this product be liable to you for any damages, including incidental or consequential damages, arising out of the use or inability to use this product.

Troubleshooting

1. If the child restraint buckle or harness release lever sticks or you cannot get the straps tight enough around child:

DO NOT LUBRICATE. Check around lever and retractor for dropped food, sticky spilled drinks, dirt, leaves, etc. Clean with warm water and/or remove object with tweezers. If you cannot get the harness to adjust and remain tight with the buckle securely locked, do not use the child restraint.

2. If your harness twists:

Straighten the harness each time you put your child in the child restraint to help prevent twisting. Lock the buckle and tighten harness so it will be ready for next use.

Anti-Rebound Bar	UAS Belt
Buckle Assembly	Tether
Seat Pad Set	Locking Clip
Removable Cup Holder	Instructions
Chest Clip	

**If requested color is not available,
similar color will be substituted.**

**Applicable tax and shipping &
handling will also be added.**

For parts availability and questions,

Call: 1-800-544-1108

Text: 1-812-652-2525

Chat: www.safety1st.com

If you already know which parts you need,
you may complete your order with a credit card
by calling us at 1-800-544-1108.

We accept Visa or MasterCard.

Hours of Operation:

M-TH from 8:00 AM to 6:00 PM EST
FRI from 8:00 AM to 4:30 PM EST

Thank you for choosing this child restraint. The DJG family is committed to creating child restraints with the most comfort and convenience available today.

Remember, parents are a child's first teachers and examples. If you always buckle your seat belt, your child will think it is the natural thing to do. Make it a firm rule that the vehicle does not go until everyone is buckled up. Make no exceptions.

No one can predict if use of a child restraint will prevent injury or death in a particular crash. However, when combined with careful driving, proper use of a child restraint can lower a child's risk of injury or death in most crashes.

If you still have questions or have any concerns with this child restraint, please contact our Consumer Care Department:

Call: 1-800-544-1108

Text: 1-812-652-2525

Chat: www.safety1st.com

Hours of Operation:

M-TH from 8:00 AM to 6:00 PM EST
FRI from 8:00 AM to 4:30 PM EST