

# Chair Assembly Instructions

Your chair comes packaged in one box.

**DO NOT use any sharp objects to open plastic wrapped components as damage to product or components may result.**

Carefully remove all of the components from the packaging and set aside for assembly. Assemble on a soft surface to prevent scratching the finish.

Estimated Assembly Time in Minutes

★ ☆ ☆  
 <15 <45 60+

## Parts List

**A** 1 x Seat

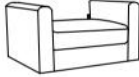

\* **D** 4 x Washers



**B** 1 x Back

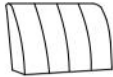

\* Replaceable Parts

\* **C** 4 x Legs

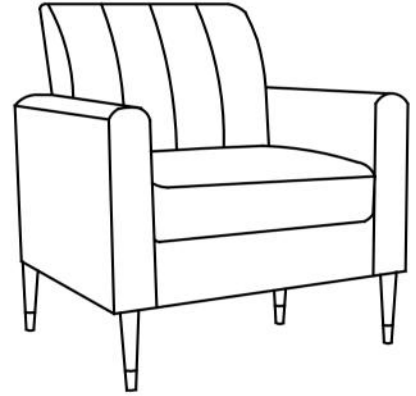

## Assembly

### Step 1

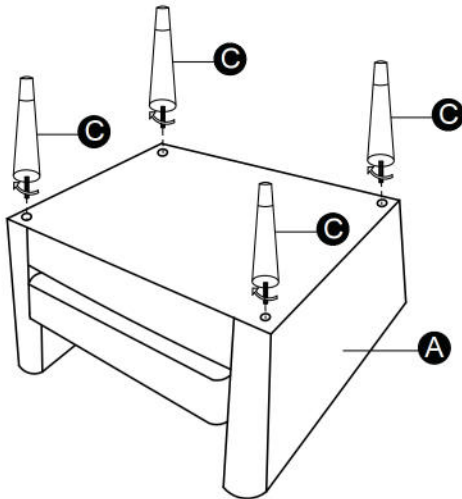

### Step 2

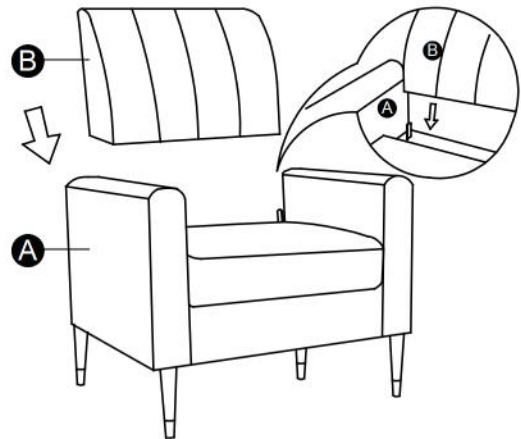

### Step 3

#### OPTIONAL

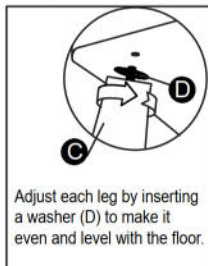

Adjust each leg by inserting a washer (D) to make it even and level with the floor.

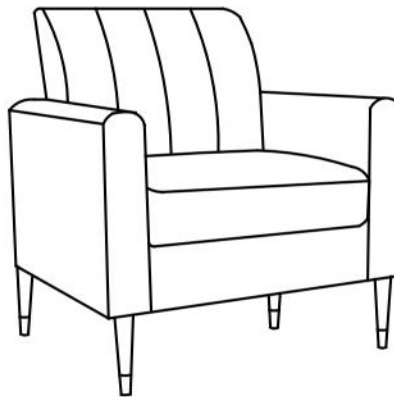

Your style may differ from images. Care for your furniture by periodically tightening all legs.

**CAUTION:** Tighten all components securely before use. Failure to do so may result in personal injury.

About your furniture piece:

- Softening of foam is natural and will happen over time with use.
- Fabric will fade or discolor in direct sunlight. Minimize exposure to direct sunlight to extend the life of your furniture.
- Wood grain, knots, streaks, and color variation occur naturally in wood and are not considered defects.

Customer Support: 866-238-0531  
 Mon-Fri 8:00am - 4:30pm CST  
[customerservice@furniturequestions.com](mailto:customerservice@furniturequestions.com)