

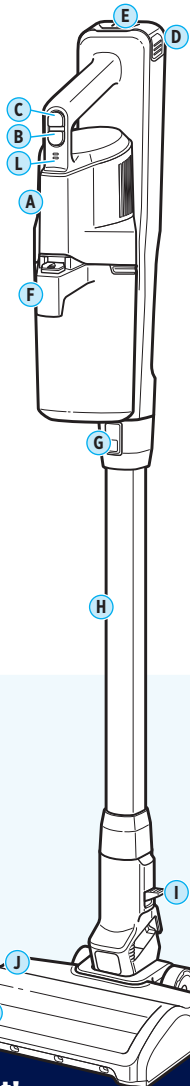

POWERCLEAN® DUALBRUSH DELUXE

STICK VACUUM
MODEL 4355

Important Safety Instructions	2
Warranty	3
Assembly	4
Charging the Battery	5
Using Your Vacuum	6
Above-Floor Cleaning	7
Emptying the Dirt Tank	8
Cleaning and Replacing the Filters	9
Maintaining the Brush Rolls	10
Troubleshooting	11



Product Overview

- | | |
|-----------------------------|----------------------------|
| A. Hand Vacuum | G. Hand Vac Release Button |
| B. Power Button | H. Extension Wand |
| C. Mode Button | I. Wand Release Lever |
| D. Battery Release Button | J. Motorized Foot |
| E. Battery | K. Brush Roll Release |
| F. Dirt Tank Release Button | L. AutoAdapt Indicator |



Meet your new BISSELL® product!

Go to support.BISSELL.com for a walkthrough of your new purchase, including videos, tips, support, and more. Want to get started right away? This guide has all the information you need to set up your new product. Let's take a look...

IMPORTANT SAFETY INSTRUCTIONS



READ ALL INSTRUCTIONS BEFORE USING YOUR APPLIANCE.

When using an electrical appliance, basic precautions should be observed, including the following:



WARNING

TO REDUCE THE RISK OF FIRE, ELECTRIC SHOCK OR INJURY:

- Unplug charger from electrical socket when not in use, before cleaning or maintaining or servicing the appliance.
- Do not use outdoors or on wet surfaces.
- Do not use motorized nozzle on wet surfaces.
- Do not allow to be used as a toy. Close attention is necessary when used by or near children.
- Do not use for any purpose other than described in this user guide. Use only manufacturer's recommended attachments.
- Do not charge with damaged charger or plug. If appliance is not working as it should, has been dropped, damaged, left outdoors or dropped into water, have it repaired by a qualified technician.
- Do not pull or carry charger by cord, use cord as a handle, close door on cord, or pull cord around sharp edges or corners. Do not run appliance over cord. Keep cord away from heated surfaces.
- Do not unplug charger by pulling on cord. To unplug, grasp the charger plug, not the cord.
- Do not handle charger, including charger plug and charger terminals with wet hands.
- Do not put any object into openings. Do not use with any opening blocked; keep openings free of dust, lint, hair, and anything that may reduce air flow.
- Keep hair, loose clothing, fingers, and all parts of body away from openings and moving parts of the appliance and its accessories.
- Use extra care when cleaning on stairs.
- Do not use to pick up flammable or combustible materials (lighter fluid, gasoline, kerosene, etc.) or use in areas where they may be present.
- If the appliance has a hand-held accessory like pet brush, motor driven head, etc. the user shall avoid entrapment.
- Do not pick up anything that is burning or smoking, such as cigarettes, matches, or hot ashes.
- Do not use without filters in place.
- Risk of injury from moving parts. Brush may start unexpectedly. Turn OFF before cleaning or servicing.
- Prevent unintentional starting. Ensure the switch is in the off-position before connecting to battery pack, picking up or carrying the appliance.
- Carrying the appliance with your finger on the switch or energizing appliance that have the switch on invites accidents.
- Disconnect the battery pack from the appliance before making any adjustments, changing accessories, or storing appliance. Such preventive safety measures reduce the risk of starting the appliance accidentally.
- Recharge only with the charger specified by the manufacturer. A charger that is suitable for one type of battery pack may create a risk of fire when used with another battery pack.
- Use only with E-TEK charger Model ZD024M300100US or ZD024A300075US
- Do not use any battery pack which is not designed for use with the vacuum.
- Use of any other battery packs may create a risk of injury and fire.
- When battery pack is not in use, keep it away from other metal objects, like paper clips, coins, keys, nails, screws or other small metal objects, that can make a connection from one terminal to another. Shorting the battery

terminals together may cause burns or a fire.

- Under abusive conditions, liquid may be ejected from the battery; avoid contact. If contact accidentally occurs, flush with water. If liquid contacts eyes, additionally seek medical help. Liquid ejected from the battery may cause irritation or burns.
- Do not use a battery pack or appliance that is damaged or modified. Damaged or modified batteries may exhibit unpredictable behavior resulting in fire, explosion or risk of injury.
- Do not expose battery pack or appliance to fire or excessive temperature. Exposure to fire or temperature above 130°C/265°F may cause explosion.
- Follow all charging instructions and do not charge the battery pack or appliance outside of the temperature range 4-40°C/40-104°F. Charging improperly or at temperatures outside of the specified range may damage the battery and increase the risk of fire.
- Have servicing performed by a qualified repair person using only identical replacement parts. This will ensure that the safety of the product is maintained.
- Do not modify or attempt to repair the battery pack except as indicated in the instructions for use and care.
- Keep the temperature range of between 4-40°C/40-104°F when charging battery, storing unit or during use.
- Do not charge the machine outdoors.
- For use only with battery pack 1644206, 1643447, 4143
- Do not turn your Vacuum ON until you are familiar with all instructions and operating procedures.
- If the appliance is to be stored unused for a long period, the batteries should be removed.
- Seek medical advice immediately if battery pack or parts of the battery pack has been swallowed.
- Do not remove battery from its original packaging until required for use.
- Do not incinerate the appliance even if it is severely damaged. The batteries can explode in a fire. Do not dismantle, open or shred battery pack. Do not subject battery pack to mechanical shock. Dispose of used batteries promptly and properly.
- Keep batteries out of reach of children.
- The battery must be removed from the appliance before it is scrapped.
- Dispose of used batteries promptly.
- The battery is to be disposed of safely.
- Keep appliance on a level surface.
- Do not carry the vacuum cleaner while in use.
- Do not use appliance in an enclosed space filled with vapors given of by oil-based paint, paint thinner, some moth-proofing substances, flammable dust, or other explosive or toxic vapors.
- Do not use to pick up toxic material (chlorine bleach, ammonia, drain cleaner, etc.)
- Do not pick up hard or sharp objects such as glass, nails, screws, coins, etc. Plastic film can be dangerous. To avoid danger of suffocation, keep away from children.
- Always turn off this appliance before connecting or disconnecting motorized foot and FurFinder Tool.

SAVE THESE INSTRUCTIONS

THIS MODEL IS FOR HOUSEHOLD USE ONLY. COMMERCIAL USE OF THIS UNIT VOIDS THE MANUFACTURER'S WARRANTY.

IMPORTANT INFORMATION

- Brush roll continues to turn while product is turned on and rotating brush tools are attached. To avoid damage to carpet, rugs, furniture and flooring, avoid tipping cleaner or setting it on furniture, fringed area rugs, or carpeted stairs during tool use.
- With brush roll on, do not allow cleaner to sit in one location for an extended period of time, as damage to floor can result.

SUPPLIER'S DECLARATION OF CONFORMITY 47 CFR SECTION 2.1077 COMPLIANCE INFORMATION Charger adapter for BISSELL product. CONTACT: BISSELL Homecare Inc., 2345 Walker Ave. NW, Grand Rapids, MI 49544. This device complies with Part 15 of FCC Rules. Operation is subject to the following two conditions: (1) this device may not cause harmful interference, and (2) this device must accept any interference received, including interference that may cause undesired operation. Caution: Any changes or modifications to this unit not expressly approved by the party responsible for compliance could void the user's authority to operate the equipment. NOTE: This equipment has been tested and found to comply with the limits for a Class B digital device, pursuant to part 15 of the FCC Rules. These limits are designed to provide reasonable protection against harmful interference in a residential installation. This equipment generates, uses and can radiate radio frequency energy and, if not installed and used in accordance with the instructions, may cause harmful interference to radio communications. However, there is no guarantee that interference will not occur in a particular installation. If this equipment does cause harmful interference to radio or television reception, which can be determined by turning the equipment OFF and ON, the user is encouraged to try to correct the interference by one or more of the following measures: (1) Reorient or relocate the receiving antenna. (2) Increase the separation between the equipment and receiver. (3) Connect the equipment into an outlet on a circuit different from that to which the receiver is connected. (4) Consult the dealer or an experienced radio/TV technician for help.

⚠ WARNING This product contains Lithium-Ion rechargeable batteries. DO NOT mix Lithium-Ion batteries with general household waste. According to Federal and State regulations, removal and proper disposal of Lithium-Ion batteries is required. For specific battery disposal instructions please contact Call2Recycle at 877-723-1297 or visit www.call2recycle.org. For full instructions on battery removal for recycling visit support.BISSELL.com.



Warranty

Limited 5-year warranty, may vary by state. Visit support.BISSELL.com or call 1-800-237-7691 for complete warranty information.

Terms and Conditions

Your purchase is subject to the BISSELL® Terms and Conditions, which includes dispute resolution through arbitration and class waiver. For complete terms or to opt out from arbitration or class waiver, visit BISSELL.com/terms-of-use or call 1-800-237-7691.

TOOLS INCLUDED IN BOX WILL DIFFER BY MODEL

To see what's included with your purchase, check the "Carton Contents" list on the top flap of the box.



Hand vacuum with Battery Installed



Extension Wand

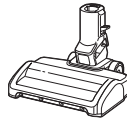

Motorized Foot



FurFinder™ Tool

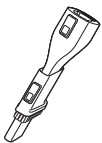

2-in-1 Dusting Brush



Additional Battery

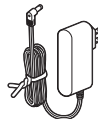

Charger

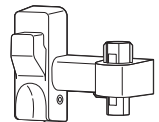

Wall Mount

Assembly

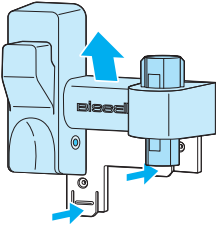

1. Pull and remove wall mount from plate.

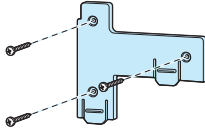

2. Secure plate to the wall with the three screws, making sure the charging cable reaches from wall mount to outlet.
Note: Use provided dry wall anchors unless drilling directly into a stud.

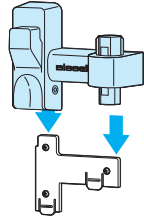

3. Slide mount onto plate until it clicks into place.

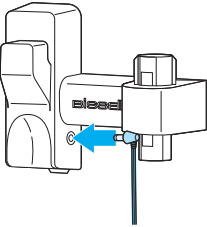

4. Install the charger to side of mount, then plug into wall.

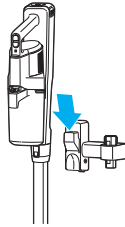

5. Place vacuum on mount.

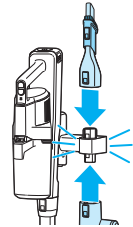

6. Install tools to mount until they click into place.

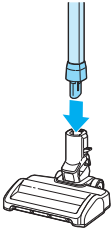

7. Install extension wand into the motorized foot until it clicks into place.



8. Install the extension wand into the hand vacuum until it clicks into place.

Charging the Battery

Charging Without Wall Mount

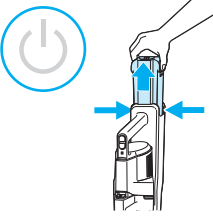
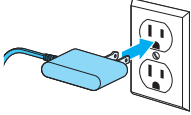
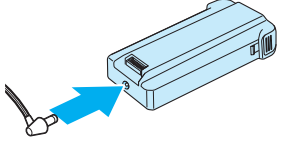
 <p>A power button icon in a circle is shown. To its right, a hand is shown pulling the battery out of the vacuum's handle. Two blue arrows point outwards from the battery release buttons on the handle.</p>	 <p>A blue charging cable is plugged into a standard two-prong wall outlet.</p>	 <p>The blue charging cable is plugged into the back of the battery pack.</p>
<p>1. Power OFF. Press and hold battery release buttons and then pull battery up to remove from vacuum.</p>	<p>2. Plug charger into wall outlet.</p>	<p>3. Plug charger into battery.</p>

Charging With Wall Mount

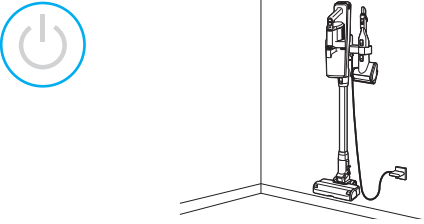
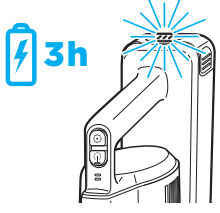
 <p>A power button icon in a circle is shown. To its right, a stick vacuum is mounted on a wall.</p>	 <p>A battery icon with a lightning bolt and '3h' next to it is shown. To its right, the vacuum is mounted on a wall with a starburst light effect on the top of the handle.</p>
<p>1. Power OFF. Place vacuum on wall mount. Machine will start charging automatically when properly mounted. Battery indicator lights will illuminate while charging.</p>	<p>2. Machine will take up to 3 hours to charge. Battery lights will turn off when fully charged.</p>

Charging on Unit Separate from Wall Mount

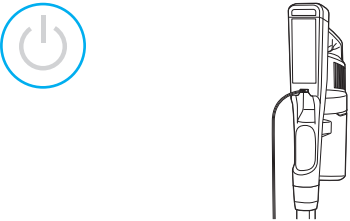
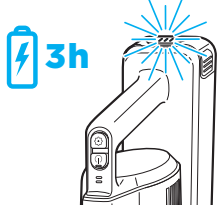

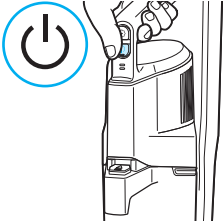
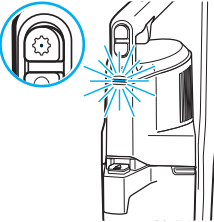
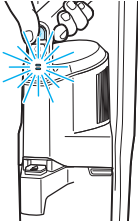

 <p>A power button icon in a circle is shown. To its right, a hand vacuum is shown with a charging cable plugged into its back.</p>	 <p>A battery icon with a lightning bolt and '3h' next to it is shown. To its right, the hand vacuum is shown with a starburst light effect on the top of the handle.</p>
<p>1. Power OFF. Plug charger into back of hand vacuum. Battery indicator lights illuminate when charging.</p>	<p>2. Machine will take up to 3 hours to charge. Battery lights will turn off when fully charged.</p>

Using Your Vacuum

This vacuum can be used as a stick vacuum, hand vacuum, or extended reach with a hand vacuum and wand. Eco mode for area rugs & carpet to prevent the brush rolls from stalling. For hard floors we would suggest Turbo Mode. For most battery efficient cleaning we recommend AutoAdapt Mode.

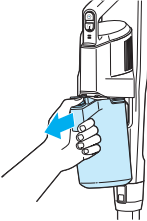
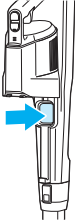
		
<p>1. Press power button to turn machine ON. It will start in AutoAdapt mode.</p>	<p>2. AutoAdapt: For most efficient battery usage, the unit will automatically adjust suction power based on debris level.</p> <p>Eco = White light: For smaller & light messes on carpet & area rugs.</p> <p>Medium = Blue light: For medium messes where higher suction power is needed.</p> <p>Turbo = Red light: For heavy messes that require the most suction power.</p>	<p>3. Suction power can be manually adjusted using the mode button.</p> <p>Eco = 1 light: For smaller & light messes on carpet & area rugs. RUNTIME: 50 mins in Hand Vacuum mode.</p> <p>Turbo = 2 lights: For heavy messes that require increased suction power. Use sparingly to preserve battery life. RUNTIME: Up to 13 minutes.</p>

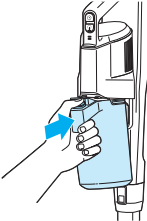
AutoAdapt Sensor Maintenance

		
<p>1. Remove the dirt tank from the hand-vac.</p>	<p>2. Inspect dust sensor lens inside the air duct for blockages.</p>	<p>3. Clean the dust sensor lens using a dry cloth.</p>
		
<p>4. Install the dirt tank.</p>	<p>5. Power on the hand vacuum and verify whether the issue has been resolved.</p>	

Above-Floor Cleaning

Using the Hand Vacuum

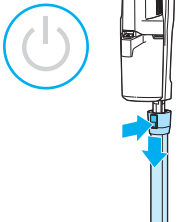
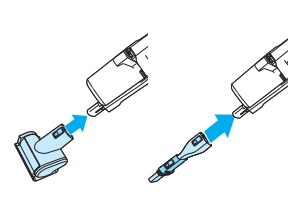
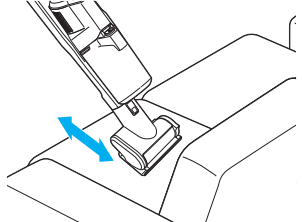
 <p>A power button icon is shown in a circle. Below it, a diagram shows a hand vacuum with a blue arrow pointing to a release button on the side of the motor head. Another blue arrow points downwards from the motor head, indicating the removal of the extension wand.</p>	 <p>A diagram shows a crevice tool being attached to the end of the hand vacuum's extension wand. Blue arrows indicate the direction of attachment.</p>	 <p>A diagram shows the hand vacuum with a crevice tool being used to clean a crevice in a piece of furniture. A blue arrow indicates the direction of movement.</p>
<p>1. Power OFF. Press release button to remove extension wand or tools.</p>	<p>2. Attach your desired tool. Note: The hand vacuum has a built-in crevice tool.</p>	<p>3. Use tool to clean furniture, carpeted stairs or other surfaces. Note: For loose fabrics, use on ECO mode. Avoid using on hard surfaces.</p>

Using the Extension Wand

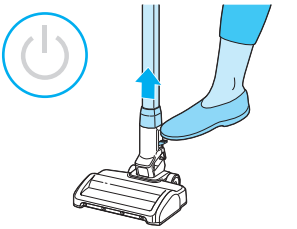
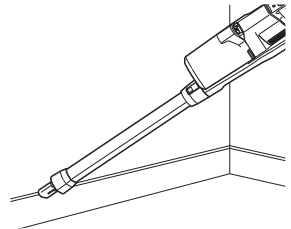
 <p>A power button icon is shown in a circle. Below it, a diagram shows a foot pressing a release lever on the side of the extension wand. A blue arrow points upwards from the foot, indicating the direction of pressure.</p>	 <p>A diagram shows the extension wand being used to clean a crevice in a corner. The wand is angled into the corner.</p>
<p>1. Power OFF. Use your foot to gently press the wand release lever. Pull up on hand vacuum to remove.</p>	<p>2. Attach your desired tool. Note: The extension wand has a built-in crevice tool.</p>

Emptying the Dirt Tank



1. Power OFF. Press dirt tank release button and pull outward to remove.

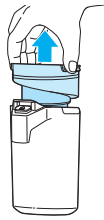

2. Remove separator from dirt tank.

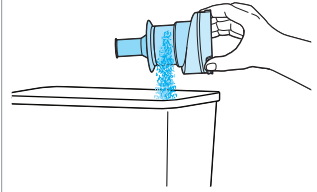

3. Tap separator on waste bin to remove debris.



4. Empty debris into waste bin.

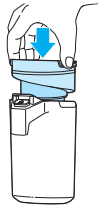

5. Install separator.

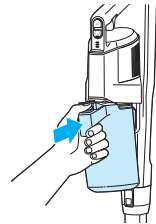

6. Install dirt tank by aligning the bottom of the tank with the notch on the hand vacuum. Press the tank towards the spine of the vacuum until it clicks into place. The tank does not need to rotate.

Cleaning and Replacing the Filters

Pre-Motor Filter

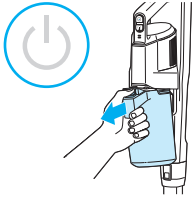
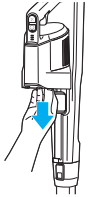
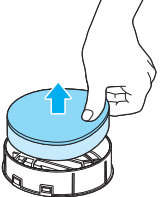
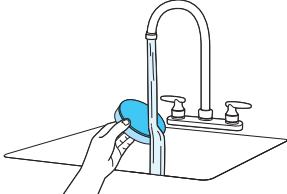
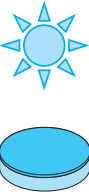
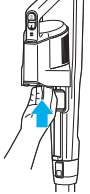
		
<p>1. Power OFF. Remove dirt tank.</p>	<p>2. Pull pre-motor filter down to remove.</p>	<p>3. Remove pre-motor filter from filter basket.</p>
		
<p>4. Rinse under warm water.</p>	<p>5. Let air dry completely before installing. Note: A wet or damp filter will affect suction performance and damage the machine.</p>	<p>6. Install the foam filter, foam side down, back into the filter basket. Insert filter basket into hand vacuum by aligning the clip with the groove and slide upwards unit secured in place.</p>

Post-Motor Filter

For optimal performance, replace the filter every 3 months.

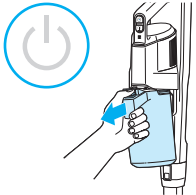
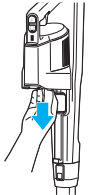
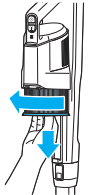
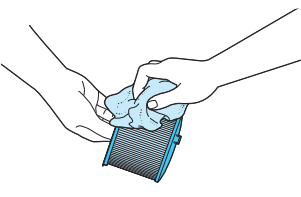
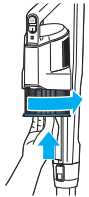
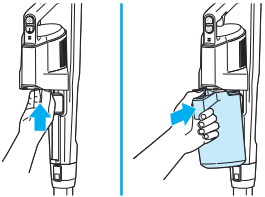
		
<p>1. Power OFF. Remove dirt tank.</p>	<p>2. Remove pre-motor filter.</p>	<p>3. Post-motor filter is located above the pre-motor filter basket inside the hand vacuum. Rotate the post-motor filter to unlock and remove.</p>
		
<p>4. Wipe post-motor filter with a dry cloth to clean off any debris.</p>	<p>5. Install filter into hand vacuum and rotate until it locks into place.</p>	<p>6. Install pre-motor filter and dirt tank.</p>

Maintaining the Brush Rolls

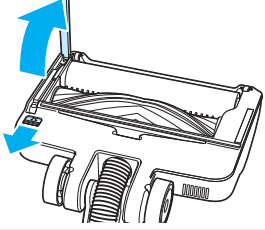
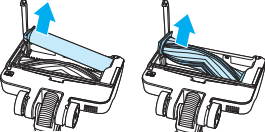
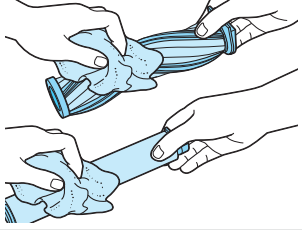
		
<p>1. Power OFF. Remove foot from extension wand. Press brush roll release button.</p>	<p>2. First, remove the smaller soft brush roll, then remove the larger standard brush roll and clear any debris.</p>	<p>3. Wipe brush rolls and chamber with a dry cloth.</p>

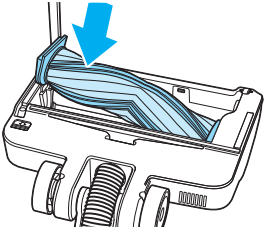
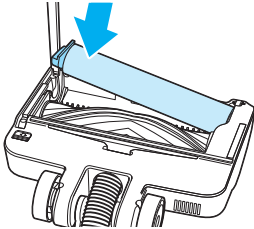
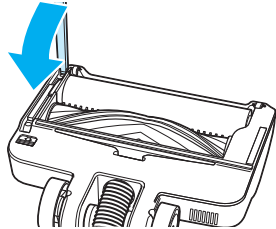
		
<p>4. Install standard brush roll into foot ensuring flat end cap faces out.</p>	<p>5. Install soft brush roll into foot ensuring flat end cap faces out.</p>	<p>6. Lower the brush roll latch until it clicks into place, securing the brush rolls.</p>

FurFinder Upholstery Tool Brush Roll

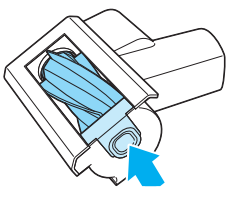
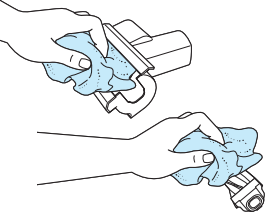
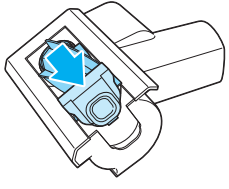
		
<p>1. Press brush roll release button and remove.</p>	<p>2. Wipe brush roll and chamber with a dry cloth.</p>	<p>3. Install brush roll into the tool until it clicks into place.</p>

Note: Any other maintenance or servicing not included in this manual should be performed by an authorized service representative.

Troubleshooting

🔧 Below are some of the issues you may run into. If you don't see the issue you're experiencing below, visit support.BISSELL.com.

Problem	Possible Cause	Remedies
Machine won't turn ON	Battery power is low.	Fully charge battery.
Dust discharges from the exhaust	Filter is damaged.	Replace filter.
	Filter is incorrectly installed.	Remove and reinstall filter.
	Filter is dirty.	Clean or replace filter.
Loss of suction	Filter is clogged.	Clean or replace filter.
	Dirt tank is full.	Empty tank.
The bottom LED of the mode setting lights flashes three times and the motor turns OFF	Complete air blockage.	Check for clogs in extension wand and filter.
Foot or upholstery tool lights blinking	Clogged brush roll.	Power OFF. Remove the foot/tool and check for debris or obstructions.
	Stalled brush roll.	Check cleaning surface. Use a lower mode setting to avoid small rugs/carpet from stalling brush roll.
Continued blinking Auto LED red	Dust Sensor Lens Blocked	<ol style="list-style-type: none">1. Remove the dirt tank from the hand vacuum.2. Inspect the dust sensor lens inside the air duct for blockages.3. Clean the dust sensor lens using a dry cloth.4. Install dirt tank until it clicks into place.5. Power on the hand vacuum and verify whether the issue has been resolved.



Every purchase makes it possible for BISSELL to continue our support of BISSELL Pet Foundation® and its mission of saving pets in need. Since 2011, BISSELL has donated over \$26 million in support of BISSELL Pet Foundation. When you purchase a BISSELL® product, you help save pets, too. Our products are engineered to clean even the toughest messes so pets can stay at home and out of shelters.

Visit [BISSELLsavespets.com](https://www.bissellsavespets.com) to learn more.

Need more support?

Head to [support.BISSELL.com](https://support.bissell.com) to troubleshoot, register your product, order spare parts, view your warranty, and more.



INFO



REGISTER



VIDEOS



PARTS



SUPPORT



©2026 BISSELL Inc. All rights reserved.
Part Number 1653598 11/25 v1