

# FALCON·SV

BODYFRIEND  
Massage Chair  
FALCON SV  
User Manual



※ The images or content descriptions in this manual may change due to product improvements without prior notice.  
※ The images in this manual are simulated for user understanding. It may be different from the actual massage chair.  
※ Product images are slightly different from the actual massage chair depending on your choice of the product model.

---

# Greetings

Thank you for purchasing the BODYFRIEND Massage Chair [FALCON SV]. Please review this user manual to ensure safe and convenient usage. Please note that product enhancements may occur without prior notice, potentially resulting in variations from the descriptions and images provided in this manual.

- ※ Please read the safety precautions first and use the product appropriately.
- ※ Please keep this manual in a place where users can access and read it at any time.
- ※ The product image or content descriptions may change due to product improvements without prior notice.

## Product Features



Leg massage unit  
Independent movement  
of each leg



Health Care



Quick On/Off  
for each body part



XD Massage



Mental Care

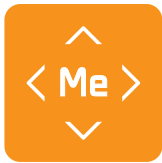

Custom Care



Cycle Mode



Nape Tension  
Relief



Inside Key



Calf Heating



Natural Leather



14 Safety Sensors

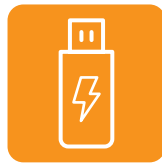

USB Charge

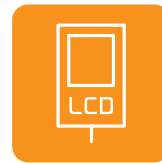

4 inch LCD Controller



Auto-connect  
Bluetooth

### XD Massage Module

The XD module helps provide an optimized massage for each individual according to their body shape and the sensed pressure.

### Separately moving leg massage unit

The left/right leg massage units move separately.

### Improved Safety

There are 14 object-detecting sensors in the leg unit and back of the massage chair to improve safety for users.

---

# Table of Contents

---

	Product Features	02
	Important Safety Instructions	04
	Grounding Instructions	05
<b>Instructions Before Use</b>	Safety Precautions	06
	Components and Descriptions	15
	Moving and Installation	16
	How to Connect the Product	17
	How to Connect Wi-Fi (Software Update)	18
<b>Controller Information</b>	Controller Button Descriptions	19
	Controller Operation Instructions	21
<b>Program Descriptions</b>	ROVO Care   Health Care	29
	Parts Care   Daily Care   Mental Care	30
<b>Special Function Information</b>	XD Module Description	31
<b>Product Specifications</b>	Product Size and Specifications	32
<b>Customer Service and Troubleshooting</b>	Customer Support Guidelines	33
<b>Product Warranty</b>	Warranty Terms and Conditions	34

---

---

# Important Safety Instructions

When using an electrical appliance, basic precautions should always be followed, including the following: Read all instructions before using (this appliance).

## **⚠ DANGER - To reduce the risk of electric shock:**

---

**01** Always unplug this device from the electrical outlet immediately after use and before cleaning.

## **⚠ WARNING - To reduce the risk of burns, fire, electric shock or injury to persons:**

---

- 01** An appliance should never be left unattended when plugged in. Unplug from outlet when not in use, and before putting on or taking off parts.
- 02** Do not operate under blanket or pillow. Excessive heating can occur and cause fire, electric shock, or injury to persons.
- 03** Close supervision is necessary when this appliance is used by, on, or near children, or disabled persons.
- 04** Use this appliance only for its intended use as described in this manual. Do not use attachments not recommended by the manufacturer.
- 05** Never operate this appliance if it has a damaged cord or plug, if it is not working properly, if it has been dropped or damaged, or dropped into water. Return the appliance to a service center for examination and repair.
- 06** Do not carry this appliance by supply cord or use cord as a handle.
- 07** Keep the cord away from heated surfaces.
- 08** Never operate the appliance with the air openings blocked. Keep the air openings free of lint, hair, and the like.
- 09** Never drop or insert any object into any opening.
- 10** Do not use outdoors.
- 11** Do not operate where aerosol (spray) products are being used or where oxygen is being administered.
- 12** To disconnect, turn all controls to the off position, then remove plug from outlet.
- 13** DANGER: Never use pins or other metallic fasteners with this appliance.
- 14** DANGER: Carefully examine the covering before each use. Discard the appliance if the covering shows any sign of deterioration, such as checking, blistering, or cracking.
- 15** DANGER: Keep Dry – Do not operate in a wet or moist condition.
- 16** WARNING: Temperatures sufficiently high to cause burns may occur regardless of the control setting. Do not use on an infant or disabled person or on a sleeping or unconscious person. Do not use on sensitive skin or on a person with poor blood circulation.
- 17** WARNING: Do Not Crush – Avoid sharp folds.

※ SAVE THESE INSTRUCTIONS

---

# Grounding Instructions

This product must be grounded. If it should malfunction or breakdown, grounding provides a path of least resistance for the electric current so as to reduce the risk of electric shock. This product is equipped with a cord having an equipment-grounding conductor and a grounding plug. The plug must be plugged into an appropriate outlet that is properly installed and grounded in accordance with all local codes and ordinances.

## **⚠ DANGER**

Improper connection of the equipment-grounding conductor can result in a risk of electric shock. Check with a qualified electrician or serviceman if you are in doubt as to whether the product is properly grounded. Do not modify the plug provided with the product - if it does not fit the outlet, have a proper outlet installed by a qualified electrician.

This products is for use on a nominal 120-V circuit and has a grounding plug that looks like the plug illustrated in sketch a below. Make sure that the product is connected to an outlet having the same configuration as the plug. No adapter should be used with this product.

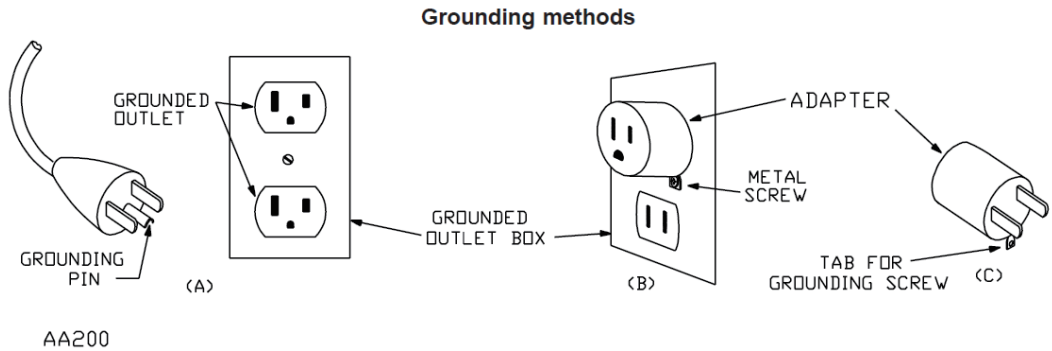

## **EARTHING**

This massage chair is a Level One Electrical Appliance. To guarantee the ground wire that is connected to the power supply socket has obtained good ground connection, make sure to use a three-core power supply socket to avoid leakage, electric shock or other negative effects during use.

※ This product is designed for personal in-home use. Commercial use will void warranty.

# Safety Precautions

- ※ The descriptions below are for using the product safely and accurately to prevent any unexpected risk or damage.
- ※ The safety precautions have two categories below depending on the expected risk and damage, and urgency if used incorrectly:



**Warning** To reduce the risk of any burn, fire, electric shock, or physical damage



**Caution** To reduce the risk of physical damage

## Precautions Before Using



### Warning

**Do not install in bathrooms or areas with high humidity.**



It may cause electric shock, fire, product deformation, or malfunction.

**Avoid using in areas with dust or areas prone to rust.**



It may cause electric shock, fire, product deformation, or malfunction.

**Do not operate in settings with temperatures exceeding 104°F.**

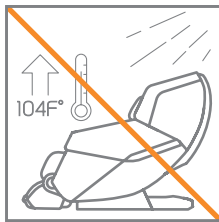

It may cause fire or malfunction.

**Do not install it outdoors.**

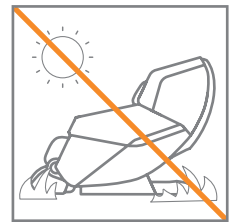

It may cause safety accidents, physical damage, product damage, or malfunction.

**Do not use near heaters or any heat-emitting objects.**

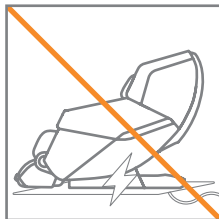

It may cause product damage, fire, or malfunction.

**Install and use only on a flat, stable surface.**

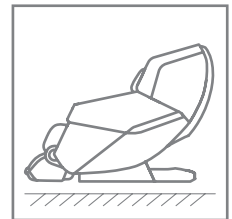

It may cause safety accidents, physical damage, product damage, or malfunction.

# Safety Precautions

## Precautions Before Using

### Warning

**Use in areas with ample space and satisfactory air circulation.**

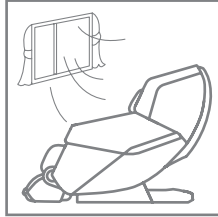

It may cause product deformation, mold, or malfunction.

**Users should not disassemble parts.**



It may cause safety accidents, physical damage, product damage, or malfunction.

**Do not use simultaneously with other electronic or medical devices.**

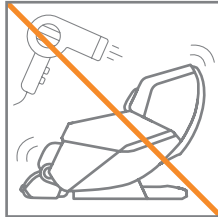

It may cause safety accidents, physical damage, product damage, or malfunction.

**Do not spill or spray foreign substances on the product.**



It may cause safety accidents, physical damage, product damage, or malfunction.

**Do not place heavy objects on this product.**

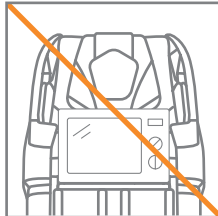

It may cause safety accidents, physical damage, product damage, or malfunction.

**Please take precautionary measures to ensure toddlers, pets, etc., do not crawl under or onto the back of the chair, leg rest, etc.**

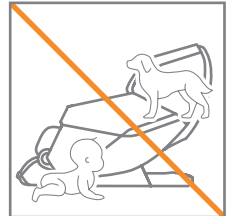

It may cause safety accidents, physical damage, product damage, or malfunction.

### Caution

**Do not install or repair without the assistance of technicians.**



It may cause safety accidents, physical damage, product damage, or malfunction.

**Do not use the product for purposes other than what is stated in this Manual.**



It may cause safety accidents, physical damage, product damage, or malfunction.

# Safety Precautions

## Precautions Before Using

### Caution

**Do not move the product by its power cable or pull the cable with your hand.**

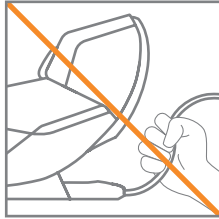

It may cause electric shock, fire, or malfunction.

**Only connect the product to outlets with protective grounding.**

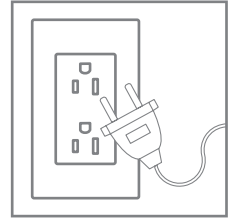

It may cause electric shock or injury.

**Check if the product is connected to power before use.**

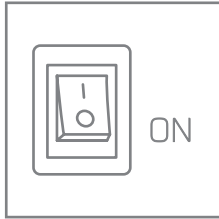

This allows for appropriate use of the product.

**Plug device into a 220-240V power outlet only.**

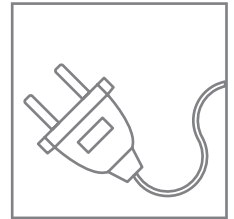

It may cause electric shock or malfunction.

**Do not install in settings where it is difficult to unplug.**

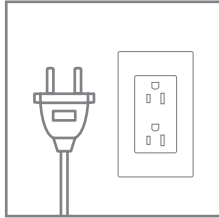

It may cause safety accidents, physical damage, product damage, or malfunction.

**When unplugging the power plug, make sure to hold the power plug itself instead of pulling the cable.**

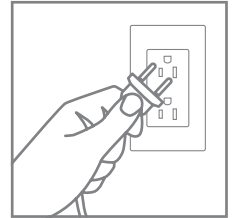

It may cause electric shock, fire, or malfunction.

**Use the massage chair after checking safety sensors and if any children or pets are around.**

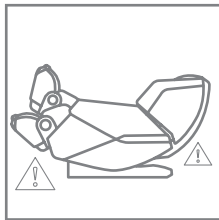

It may cause safety accidents, physical damage, product damage, or malfunction.

**Please note that the sheets may become discolored from dark-colored clothes, including jeans.**

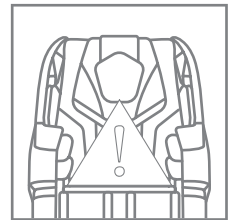

It may cause sheet discoloration.



# Safety Precautions

## Precautions for Use

### Warning

**Check how to use the product and its possible side effects.**

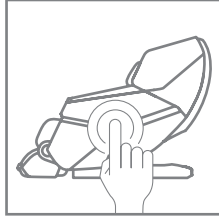

This allows for appropriate use of the product.

**Do not connect or disconnect the power plug with wet hands. It may cause electric shock.**

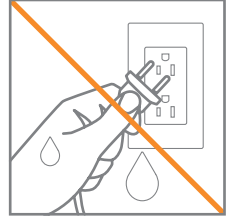

It may cause electric shock, fire, or malfunction.

**Do not use the chair if your body is wet.**



It may cause electric shock, fire, or malfunction.

**Do not use the massage chair directly after a heavy meal.**

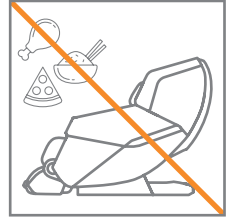

It may cause physical damage.

**Be careful not to let any body parts get caught during use.**

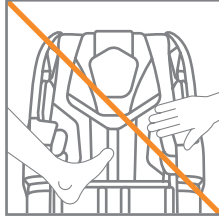

It may cause safety accidents, physical damage, product damage, or malfunction.

**Be careful not to focus on a certain body part for too long as it may become excessive.**

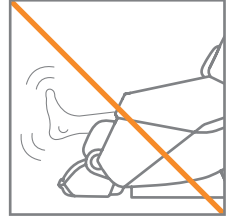

It may cause safety accidents, physical damage, product damage, or malfunction.

**Disconnect the power plug from the socket when the massage chair is not in use.**

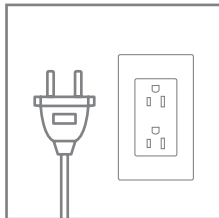

It may cause electric shock or malfunction.

**Toddlers and babies should not use the massage chair.**

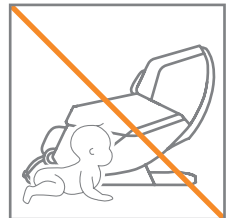

It may cause safety accidents, physical damage, product damage, or malfunction.

**Do not place your head, elbows, chest, abdomen or knees on the massage chair and attempt to use it.**

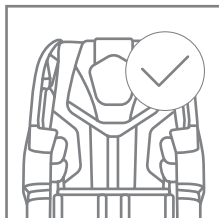

It may cause safety accidents, physical damage, product damage, or malfunction.

**Control the massage balls to ensure they are being operated in the right position.**

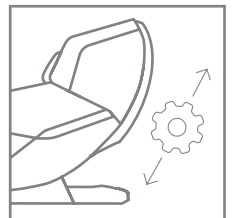

It may cause safety accidents, physical damage, product damage, or malfunction.

# Safety Precautions

## Precautions for Use

### Warning

**Wait until the reclining unit returns to its original position to get off the chair.**

It may cause safety accidents, physical damage, product damage, or malfunction.

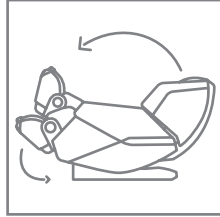

**Stop using the massage chair immediately if you experience any pain or discomfort and take appropriate measures for your health.**

It may cause physical damage.

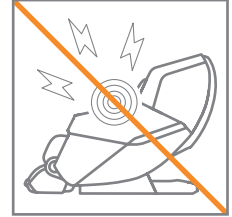

**Consecutive uses may burden your body. Select whether to keep using it according to your health condition.**

It may cause physical damage.

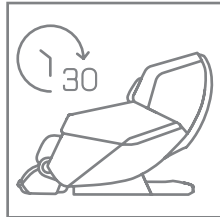

**Prevent children or pets from playing around the massage chair during the operation.**

It may cause safety accidents, physical damage, product damage, or malfunction.

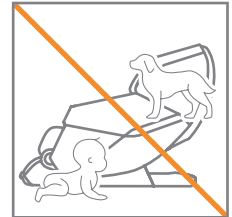

**Do not operate the massage chair where aerosol (spray) products are being used or oxygen is being administered.**

It may cause product damage, fire, explosion or malfunction.

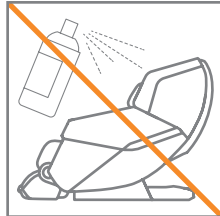

**Do not operate the massage chair when wearing accessories.**

It may cause safety accidents, physical damage, product damage, or malfunction.

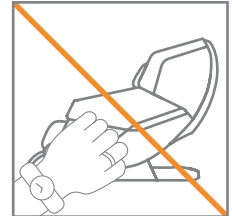

**Ensure that long hair does not become entangled in the massage chair.**

It may cause safety accidents and physical damage.

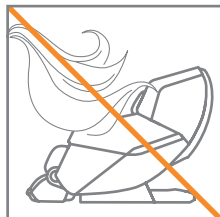

**Do not drop or insert any objects in the empty spaces.**

It may cause safety accidents, physical damage, product damage, or malfunction.



**If the cable or plug malfunctions, is damaged, or is soaked in water, do not operate the massage chair. Contact the Customer Service Center for inspection and repair.**

It may cause electric shock, fire, or malfunction.

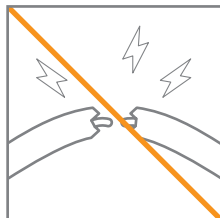

**Be aware not to burn when using the heating feature.**

It may cause a low-temperature burn.

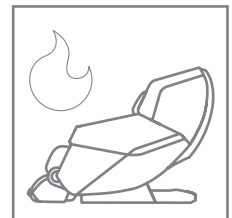

# Safety Precautions

## Precautions for Use

### Warning

**Sit in an appropriate position in the massage chair.**

It may cause safety accidents, physical damage, product damage, or malfunction.

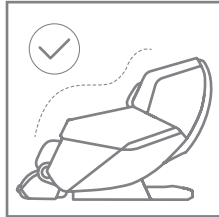

**Do not use the massage chair when the cover is torn or removed.**

It may cause safety accidents, physical damage, product damage, or malfunction.

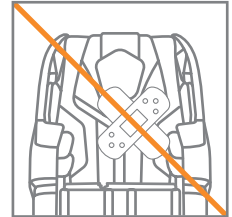

### Caution

**Do not let more than two people operate the massage chair at the same time.**

It may cause safety accidents, physical damage, product damage, or malfunction.

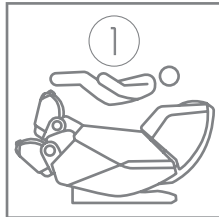

**Avoid using the massage chair where the ambient temperature rapidly changes.**

It may cause physical damage or injury.

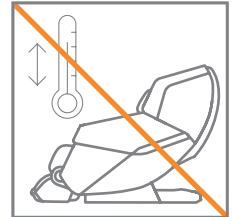

**Do not apply more than 264 lbs pressure on the product.**

It may cause safety accidents, deformation, noises, product damage, or malfunction.

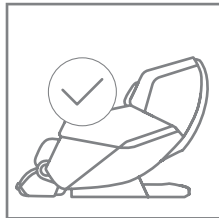

**People shorter than 5' or taller than 6'3" may feel different when massaging.**

It may cause a lack of tightness between massage product damage, or malfunction.

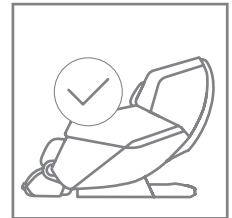

**Do not stand on the massage chair. Please use it in the sitting position.**

It may cause safety accidents, physical damage, product damage, or malfunction.



**Be careful of catching hypothermia when falling asleep after a massage.**

It may cause safety accidents, physical damage, etc.

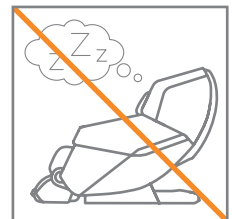

# Safety Precautions

## Precautions for Use

### Caution

**Make sure the cable is not damaged or excessively bent.**

It may cause electric shock, fire, or malfunction.

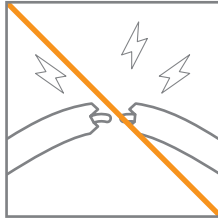

**Please start at a lower intensity for safe use.**

It may cause physical damage.

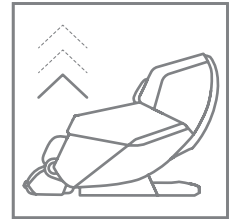

**Do not hold the leg massage unit with your hands.**

It may cause safety accidents, physical damage, product damage, or malfunction.

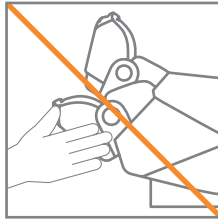

**Do not lean or hang on the back side of the massage chair.**

It may cause safety accidents, physical damage, product damage, or malfunction.

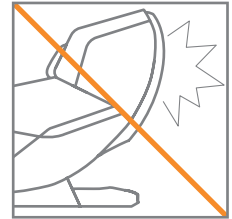

**Prevent pets from biting the power cable.**

It may cause electric shock, product damage, or malfunction.

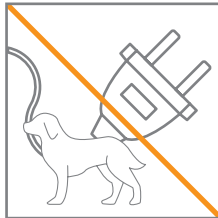

**Do not stand on the leg rest when the massage chair is reclining.**

It may cause safety accidents, physical damage, product damage, or malfunction.

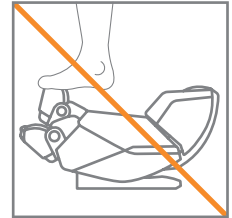

**Please ensure the power switch is off before connecting the power.**

It may cause electric shock, product damage, or malfunction.

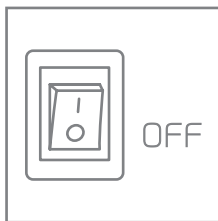

**Do not sit on the back of the massage chair, arm massage unit, or leg massage unit.**

It may cause safety accidents, physical damage, product damage, or malfunction.

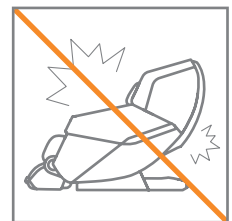

# Safety Precautions

## Precautions for Use

### Caution

**Store the controller in the given position and do not pull or hit it.**

It may cause safety accidents, physical damage, product damage, or malfunction.

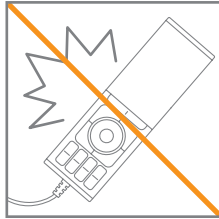

**Do not smash the controller buttons, and be wary that no button is pressed.**

It may cause safety accidents, physical damage, product damage, or malfunction.

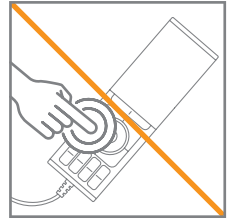

**Do not use the Bluetooth speaker at a loud volume for a long period of time. (\*Applies to some massage chairs)**

It may damage your hearing ability.

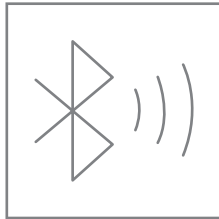

**Do not wash the product with water.**

It may cause electric shock, fire, or malfunction.

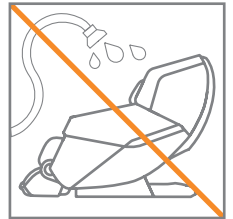

**Please disconnect the power plug before cleaning or mending the massage chair.**

It may cause safety accidents, physical damage, product damage, or malfunction.

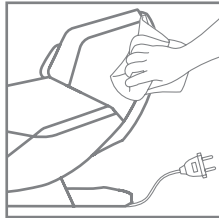

**Gently remove dirt with a soft cloth and do not use organic solvents, such as thinner, or chemicals.**

It may cause product damage.

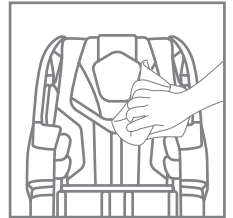

**Use a sealed cable when charging via the USB charging port. (\*Applies to some massage chairs)**

It may cause electric shock, fire, or malfunction.

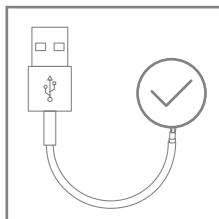

※ Sealed cable refers to a cable with a protected cord covered with aluminum foil, copper, or steel nets to reduce noise from the outside and inside.

---

# Safety Precautions

## Instructions Before Use

---

### Precautions

---

- **Do not use the product if**
  - Doctor diagnoses to not use this massage chair for those who suffer from thrombosis, embolism, a serious varicose veins
  - Pregnant women in the first trimester or the beginning of the third pregnancy trimester
  - Those who suffer from severe diseases related to the heart, kidneys, or liver
  - Those who suffer from schizophrenia or other mental disorders
  - Those who suffer from uncontrollable epilepsy or other brain diseases
  - Those who cannot move by themselves
- **Before use, consult with a specialist if**
  - Pregnant women other than those who are within the first trimester and may experience side effects from the use
  - Those who have higher body temperature and suffer from acute inflammation, including chills and fever
  - Those who suffer from severe skin disease, including pressure sore or burn
  - Those who suffer from a malignant tumor
  - Those who are old, suffer from extreme weight loss or loss of muscle tissue due to other diseases
  - Those who need to stay in bed due to medical treatment
  - Those who are diagnosed with acute disc and acute cervical sprain
  - Those who suffer from severe osteoporosis
  - Those who are using implantable electronic medical devices, including implantable pacemaker
  - Those who lack communication ability
  - Those who have difficulty moving their body
  - Those who have any other health concerns
  - Those with joint discomfort due to hip or knee joint surgeries (artificial joint, fracture, etc.)

---

### Instructions for Use Heating Feature

---

- If using the product long without rest, it may cause a low-temperature burn or any other risks.
- Do not let skin come in direct contact with parts of the massage chair that heat up.
- Supervise young children, seniors, and patients when they are using this product as they have sensitive skin.
- Do not fall asleep with the heating function on.

---

### Possible Side Effects

---

- **Please note the following side effects, which may occur during use.**
  - Minor abrasions, bruising, etc.
  - Damage to muscle or tendon injury due to overuse or too much pressure
  - Allergic reactions and burns
  - Elderly spine fractures, dislocated joints, etc.

---

# Components and Descriptions

## Opening the box

---

This product is packaged in two boxes. Please check that you have received all the necessary parts.

- **Body Box:** Body, Back/Butt Sheet, Head Sheet, Shoulder Massage Units, Accessory Box (Controller, Power Cable, And User Manual)
- **Leg Massage Unit**

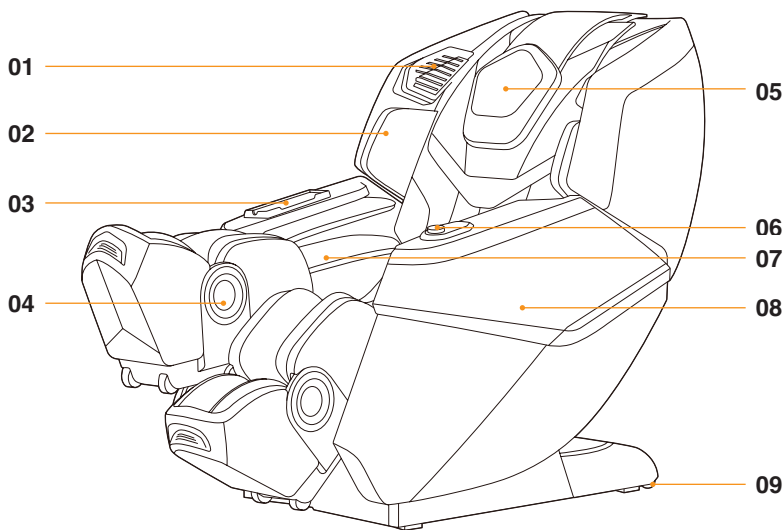

---

### Exterior

- 01 Speaker
  - 02 Shoulder Massage Unit
  - 03 Controller Storage
  - 04 Leg Massage Unit
  - 05 Head Sheet
  - 06 Inside Key
  - 07 Arm Massage Unit
  - 08 Side Panel
  - 09 Wheels for ease of movement
- 

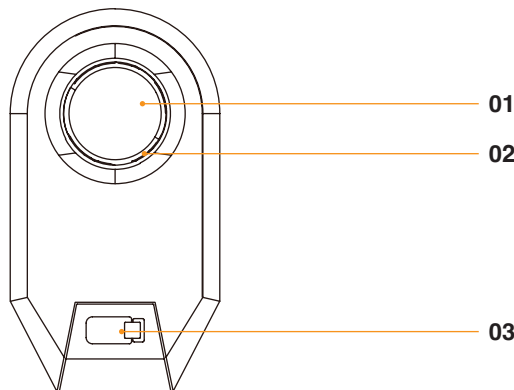

---

### Inside Key

- 01 Power / ROVO Care
    - ※ Power: Press and hold the button to turn the power on or off.
    - ※ ROVO Care: This button will quickly transition the massage mode to a different ROVO Care if pressed during operation.
  - 02 Adjust Reclining Angle
    - ※ Turn the dial clockwise to elevate the chair's position and turn it counterclockwise to recline.
  - 03 USB Charging Port
-

# Moving and Installation

## Moving method and checking for leg room

- Before installation, check whether there is enough room for installation.
- Remove all obstructions or miscellaneous objects around the product.
- Do not install the product with its back facing a glass window.
- Recline the product until it is convenient enough to move, then move it to the desired location.  
Install it by slowly putting it down.
- Be careful that the cables do not become stuck under the product during installation.

- ※ The weight of the product may cause damage or discoloration to the floor.
- ※ When moving the product, make sure more than two people carry it together.

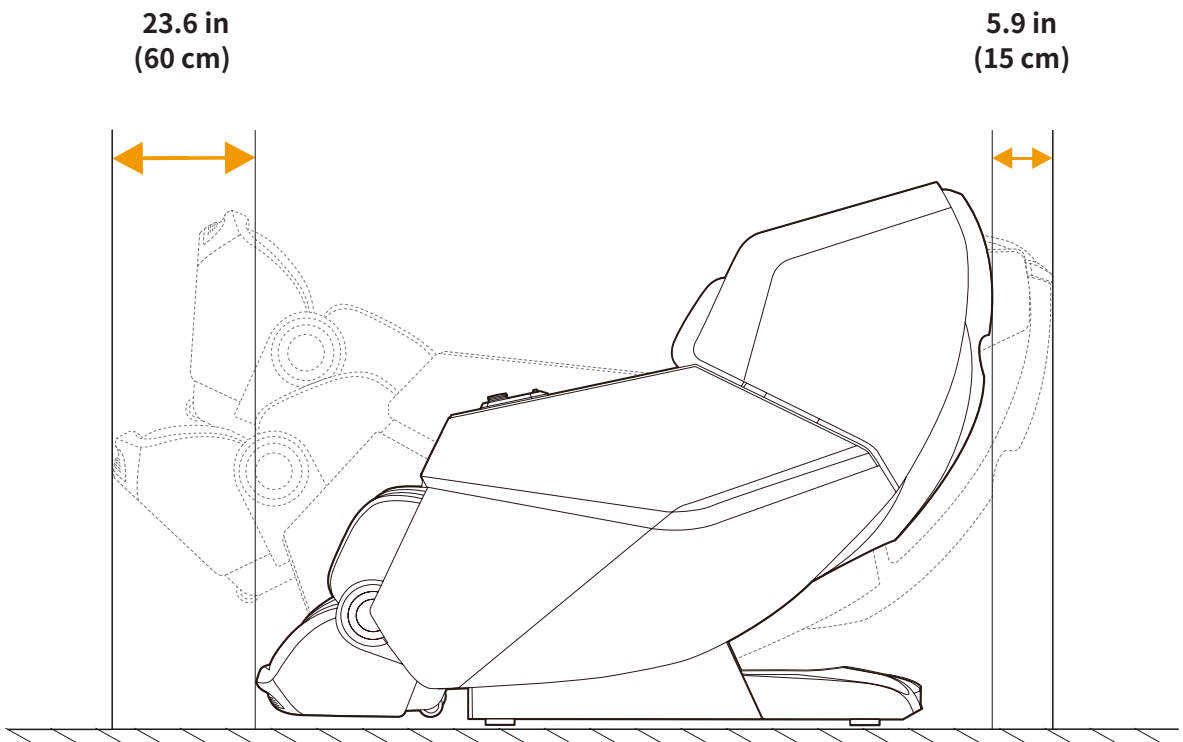



---

# How to Connect the Product

## Connecting the controller

---

Plug the controller cable to the controller connector located inside the right side panel.

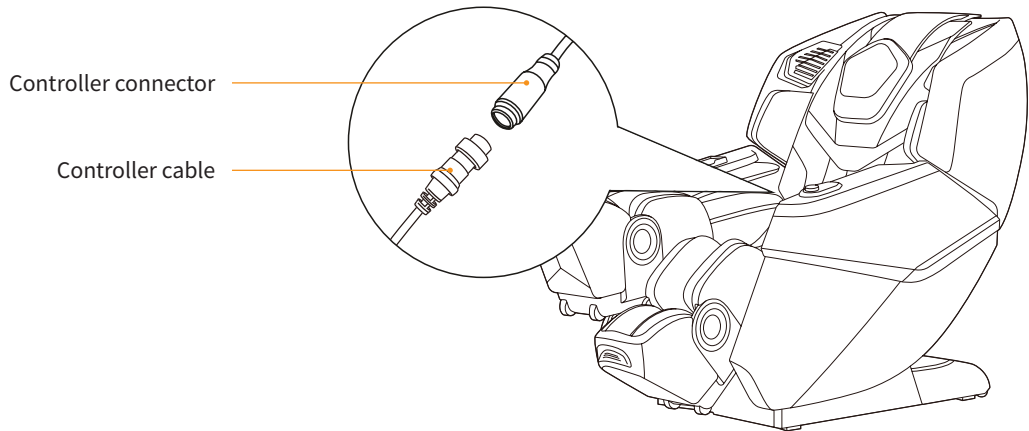

## Connecting to power source

---

Plug the power cable into the power port positioned at the rear bottom.  
Turn the power switch on after connection.

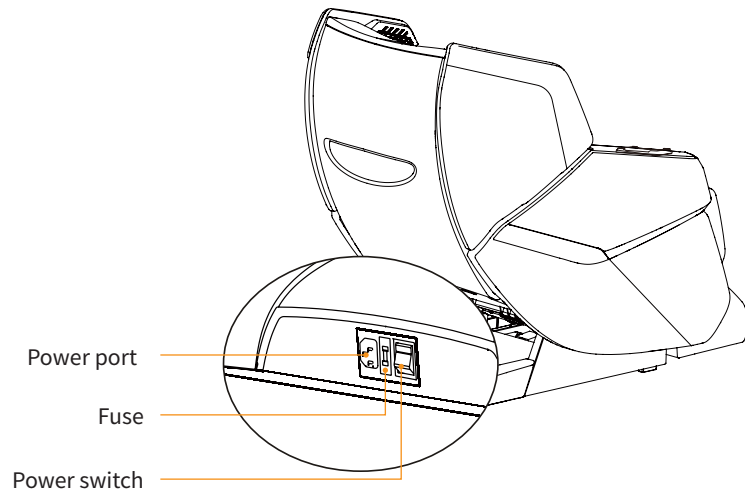

---

# How to Connect Wi-Fi

## Connecting to Wi-Fi

---

**BODYFRIEND [Wi-Fi Connection Assistant] app enables the latest software updates without any service technician.**

### 1. Check before connection

Check if the product and Wi-Fi router are connected to the power.

- ※ Check if the router supports 2.4GHz. (5 GHz not supported)
- ※ Check the SSID (router name) and password of the Wi-Fi router in use.

### 2. Install the app

Smartphone - Search for [Bodyfriend Wi-Fi Connection Helper] in Google Play Store or Apple App Store and download the app.

Complete the connection by following the instructions in the app.

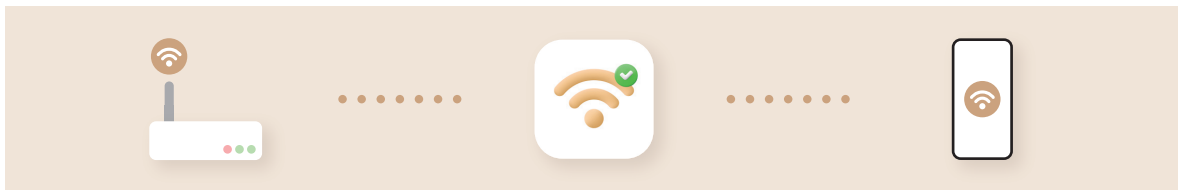

## Notes

---

- 01** This BODYFRIEND product supports 2.4 GHz only. (5 GHz not supported)
- 02** Some smartphones may fail to connect to Wi-Fi due to their device settings.
- 03** The app is supported in Android OS ver. 5.0 or higher/iOS ver. 12.0 or higher.
- 04** Wi-Fi connection may fail due to an unstable network or firewall.
- 05** If you fail to connect to Wi-Fi after taking measures instructed by the Internet service provider, please contact our customer service.
- 06** Service features may vary due to product specifications and changes by the app updates without previous notice.



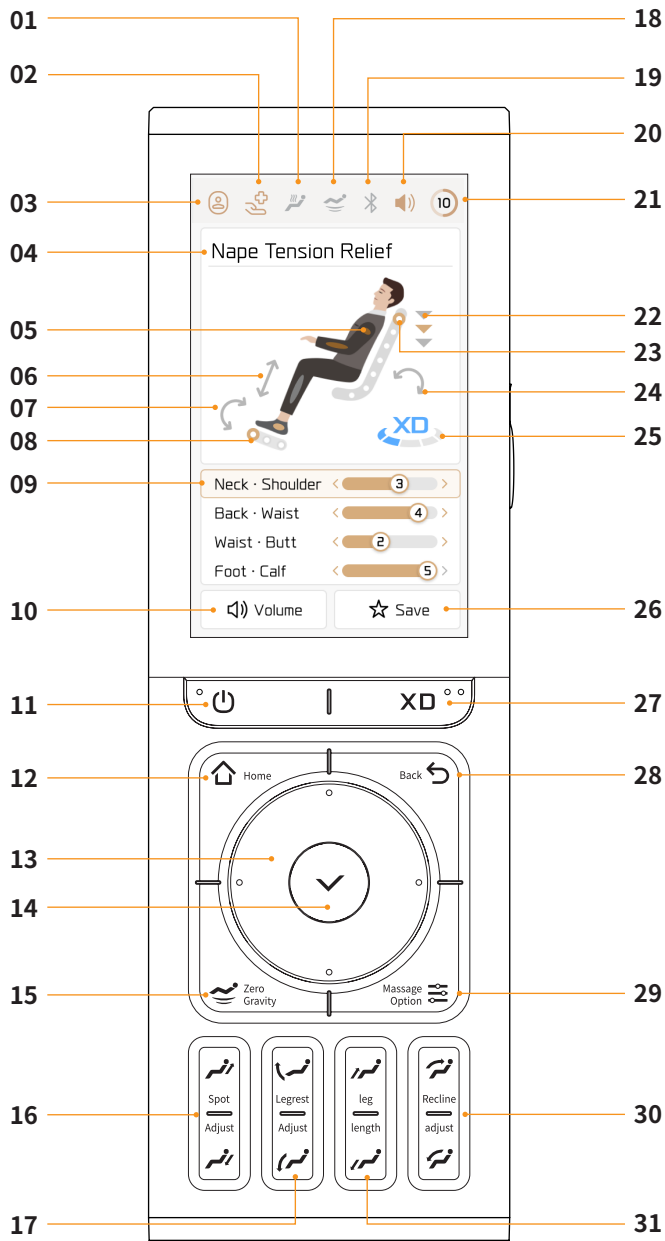





# Controller Button Descriptions

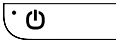

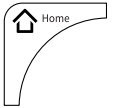
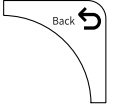
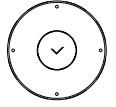
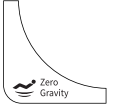
## Controller Components

- 01 Heating Indicator
- 02 Auto/Manual Program Indicator
- 03 Profile Indicator
- 04 Current Massage Mode Indicator
- 05 Airbag Indicator
- 06 Leg Length Adjust Indicator
- 07 Leg Angle Adjust Indicator
- 08 Sole Roller Indicator
- 09 Neck · Shoulders Massage Speed  
Back · Waist Massage Speed  
Waist · Butt Massage Speed  
Sole · Calf Massage Speed
- 10 Volume Adjust (Go to Settings)
- 11 Power/Pause
- 12 Home
- 13 Up/Down/Left/Right
- 14 OK
- 15 Zero Gravity Angle Settings
- 16 Spot Adjust
- 17 Legrest Adjust
- 18 Zero Gravity Indicator
- 19 Bluetooth Connectivity
- 20 Volume Intensity Level
- 21 Massage Time
- 22 Shoulder Position
- 23 Massage Module Position
- 24 Full Body Angle Adjust Indicator
- 25 XD Intensity Level
- 26 Add to Favorites
- 27 XD Intensity Level Settings
- 28 Back
- 29 Massage Option
- 30 Recline Adjust
- 31 Leg Length

# Controller Button Descriptions

	<b>Power/ Pause</b>	<p><b>Power:</b> If the [Power button] is pressed during operation, check the guide screen, and choose Yes. All movement will stop and all massage balls and parts of the massage chair will return to their original position.</p> <p><b>Pause:</b> If [Power button] is pressed during operation, the massage chair will pause. When you check the guide screen and select No, the massage will resume.</p> <p>※ [●] Braille: Braille is indicated for the visually impaired.</p>
	<b>XD Intensity Levels</b>	<p>You can customize the range for the roller heads to protrude along the contours of your body.</p> <p>※ [●●] Braille: Braille is indicated for the visually impaired.</p>
	<b>Home</b>	<p>If the [Home button] is pressed, it will lead to the Home screen.</p>
	<b>Back</b>	<p>Go to the previous screen.</p>
	<b>Up/Down/ Left/Right, OK</b>	<p>Move and select by [Up/Down/Left/Right button] and run by [OK button]. In the massage screen, select the desired massage part using the [Up/Down button], and adjust the massage speed levels using the [Left/Right button].</p>
	<b>Zero Gravity</b>	<p>This button will transit the body into the zero-gravity position, which is an ideal posture for massages.</p> <p>※ In some modes, you can manually change the angle after the indication of auto leg adjust is off pops up.</p>
	<b>Massage Option</b>	<p>Controls roller, heating, and airbag intensity levels.</p>
	<b>Spot Adjust</b>	<p>Manually adjust shoulder position during Auto massage.</p> <p>※ During Custom Care, there is a separate 'Fix Massage Ball' menu and during Parts Care, pressing [Massage Position Button] does not fix it in one position.</p>
	<b>Legrest Adjust</b>	<p>This button adjusts the leg angle. You can adjust the individual left/right leg massage units.</p> <p>※ In some modes, you can manually change the angle after the indication of auto leg adjust is off pops up.</p> <p>※ When the leg angle changes, the leg length will be measured again. For accurate measurement, put the heel deep inside the leg units.</p>
	<b>Leg Length</b>	<p>Adjusts the leg length. You can adjust the individual left/right leg massage units.</p> <p>※ In some mode, you can manually change the length after indication of auto leg adjust is off pops up.</p>
	<b>Recline Adjust</b>	<p>This button adjusts the reclining angle.</p> <p>※ In some modes, you can manually change the angle after the indication of auto leg adjust is off pops up.</p>

# Controller Operation Descriptions

## Start

[Power button] > Select the desired mode and press the [OK button] > Sense body and adjust shoulders > Start massage

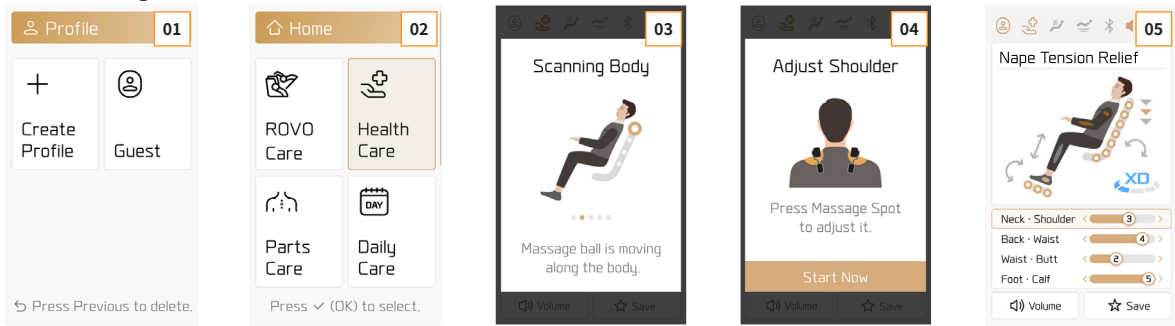

### 01 Create a New Profile

Click [Create New Profile] and select a name to create your own profile.

- ※ When using a registered profile, body shape measurement, shoulder position are automatically saved after the first session. 'Massage Speed, Rolling Speed, Air Strength, and XD Strength' set for each program are also automatically saved.
- ※ Guest profiles have some services restricted.

### 02 Home Screen

This will pop up when pressing the [Home button]. Users can select their desired program and other massage chair feature details.

### 03 Checking for the Contour of User's Body

When the massage starts, the chair will automatically check and set up for the contour of your body. Please keep your back straight while checking for the contour.

### 04 Adjust Shoulder Unit Position

After checking the contour, the Adjust Shoulder Unit Position screen will appear. Press the [Spot Adjust button] to change position and press the [OK button].

- ※ When pressing the [OK button], the massage will start immediately. When not pressed, massage will automatically start 10 seconds later.

### 05 Message Status Screen

This screen shows the status and time of the current massage. Select the desired massage location using the [Up/Down button] and adjust the massage speed using the [Left/Right button].

## Finish

[Power button] > Check the guide screen and select End > Massage ends

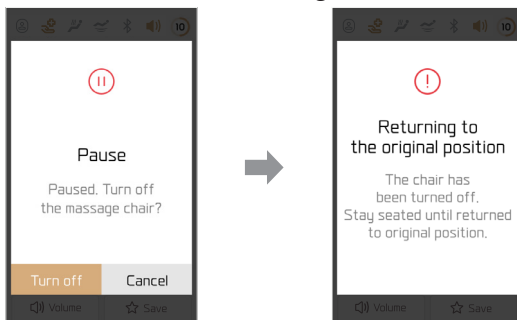

# Controller Operation Descriptions

## Separately-moving leg massage unit by left/right

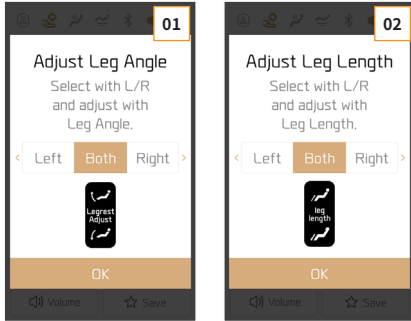

### 01 Adjust Leg Angle

[Legrest Adjust button] > Select left, right, or both by pressing the [Left/Right button] > Adjust the angle by using the [Legrest Adjust button] or [Up/Down button] > [OK button]

### 02 Adjust Leg Length

[Leg Length button] > Select left, right, or both by pressing the [Left/Right button] > Adjust the length of each unit by using the [Leg Length button] or [Up/Down button] > [OK button]

## Object detection notice

Object detection guide screen > Remove the object and press the [OK button] > Resume massage

※ If the product continues to show the Object Detection screen after removing the object, press and hold the [OK button] to return to its original position.

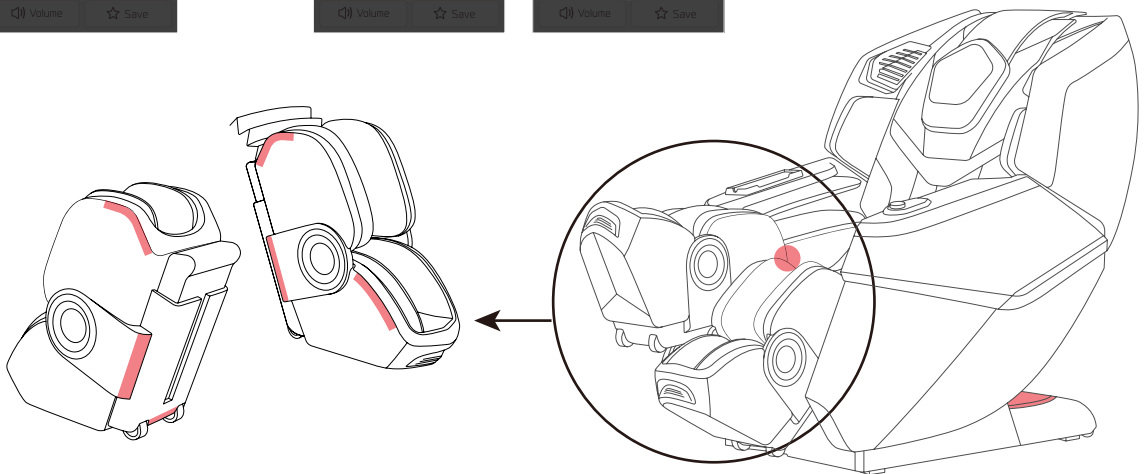
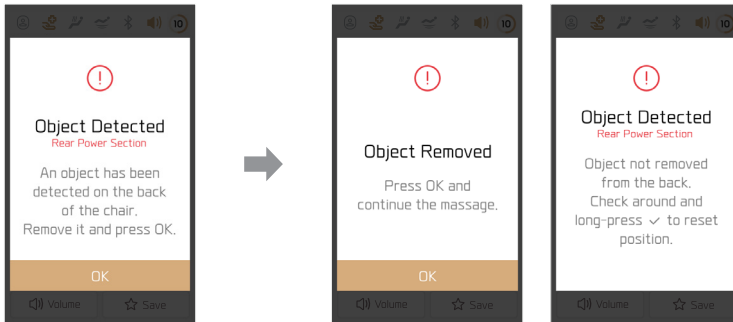

※ Object detection sensors are positioned at a total of 14 places at the leg units and back of the massage chair.

# Controller Operation Descriptions

## Adjust shoulder unit position

### Auto Program (ROVO Care, Health Care, Parts Care, Daily Care, Mental Care)

**01** When pressing the [Spot Adjust button] in the lower region of the controller during the auto program, the current massage and song will be paused and guide screen for re-adjusting shoulder unit position will appear.

**02** Adjust the shoulder unit position by the [Spot Adjust button] or [Up/Down button], press [OK button], and the massage will resume.

※ Custom Care has a separate Message Ball - Fixed menu.

During the massage for each body part, pressing the [Spot Adjust button] will not fix the massage spot.

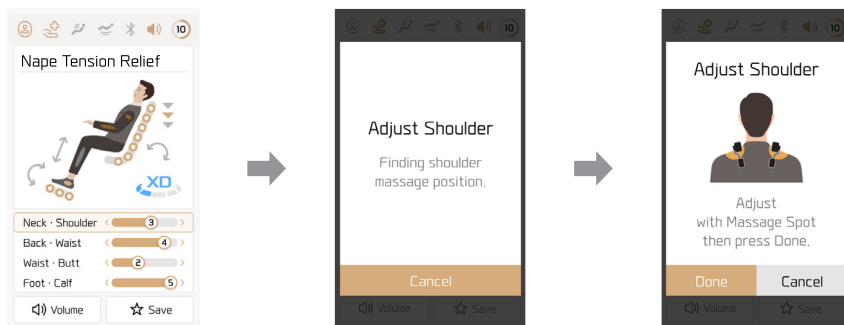

## Quick ON/OFF by each body part

Quick ON/OFF for each body part sets up each Airbag and Roller features for each body part in the Massage Status screen.

### [How to Operate]

**01** Massage Status screen > Go to the human image at the top by using the [Up/Down button] and select the desired body part among Lower Body/Arms/Shoulders.

**02** Select the desired body part and turn on/off the Airbag or Roller features.

※ Arms, Shoulders only allows turning Airbags on/off.

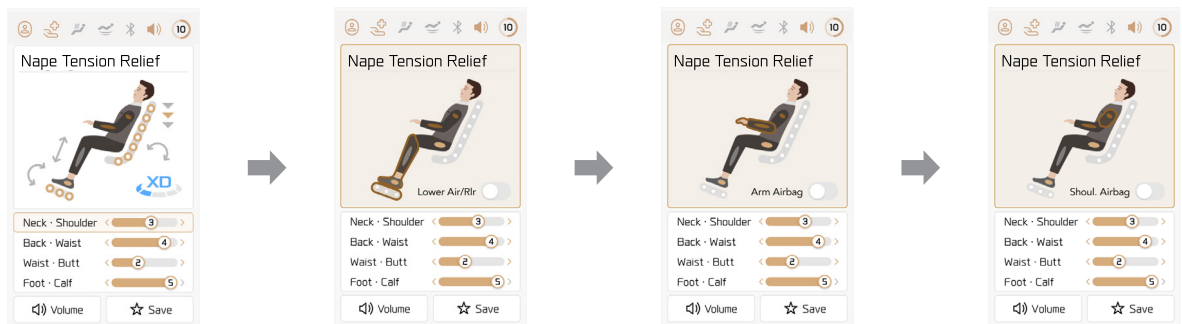

# Controller Operation Descriptions

## ROVO Care

Home > ROVO Care > Select a mode and press the [OK button] > Sense body and adjust shoulders > Start massage

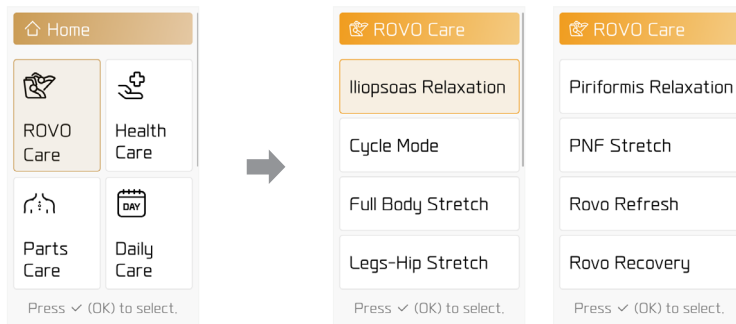

## Health Care

Home > Health Care > Select a mode and press the [OK button] > Sense body and adjust shoulders > Start massage

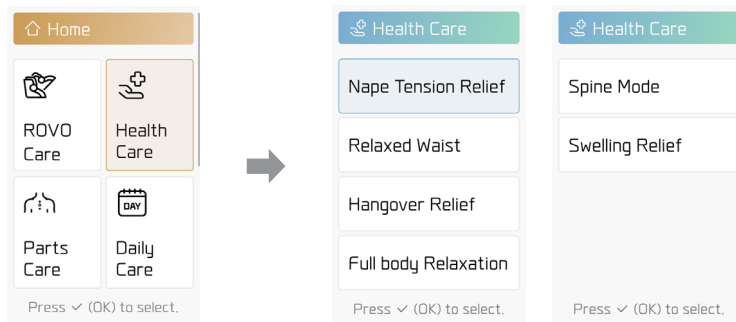

## Parts Care

Home > Parts Care > Select a mode and press the [OK button] > Sense body and adjust shoulders > Start massage

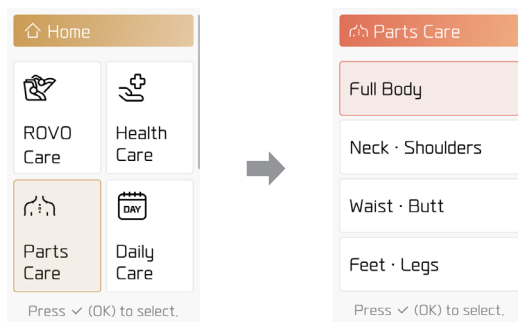



# Controller Operation Descriptions

## Daily Care

Home > Daily Care > Select a mode and press the [OK button] > Sense body and adjust shoulders > Start massage

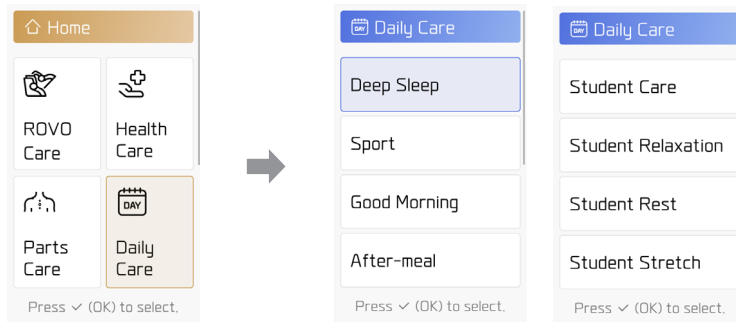

## Custom Care

Home > Custom Care > Select Message Area > Select Message Style > Select Roller Width > Select Message Option > Select 'Start Cust. Care' and press the [OK button] > Start massage

- ※ Message Area - Arms and legs can only be set as 'Select Option'.
- ※ The message head movement range can only be set for the Message Area - 'Direct Selection'.
- ※ Message style - It is not possible to set the massage ball spacing for the 'kneading' option.

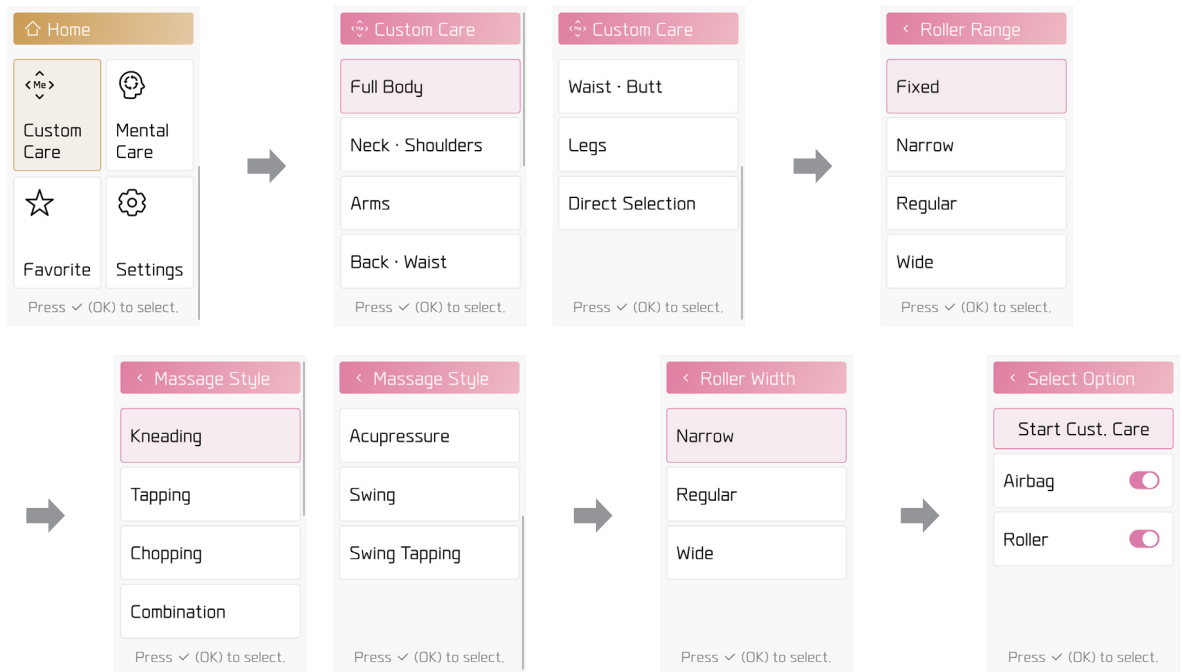

# Controller Operation Descriptions

## Mental Care

Home > Mental Care > Select a mode and press the [OK button] > Sense body and adjust shoulders > Start massage

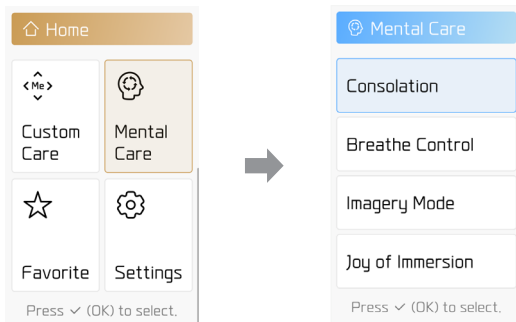

## Favorite

- 01 Registration:** Run the desired mode > Custom Massage settings > Register as a Favorite.
- 02 Run:** Home > Favorite > List > Select the desired mode among the favorite > press the [OK button]
- 03 Manage the list:** Users can register up to 8 Favorite. Users can remove unnecessary modes on “Favorite - Manage”.

※ When the Favorite mode changes, it is registered as a new Favorite mode.

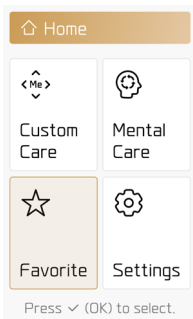

### [Favorite Save History Range]

#### Auto Program

- 01 Select Mode
- 02 Massage Speed for Each Body Part
- 03 XD Intensity
- 04 Airbag Intensity for Each Body Part
- 05 Music

#### Custom Care

- 01 Massage Spot
- 02 Massage Technique
- 03 Massage Width
- 04 Vertical Speed
- 05 XD Intensity
- 06 Massage Position
- 07 Back Unit Angle & Position
- 08 Leg Angle & Position
- 09 Airbag Intensity for Each Body Part

## Roller

Home > Settings > Message Option > Roller > Adjust the speed among 0~5 levels

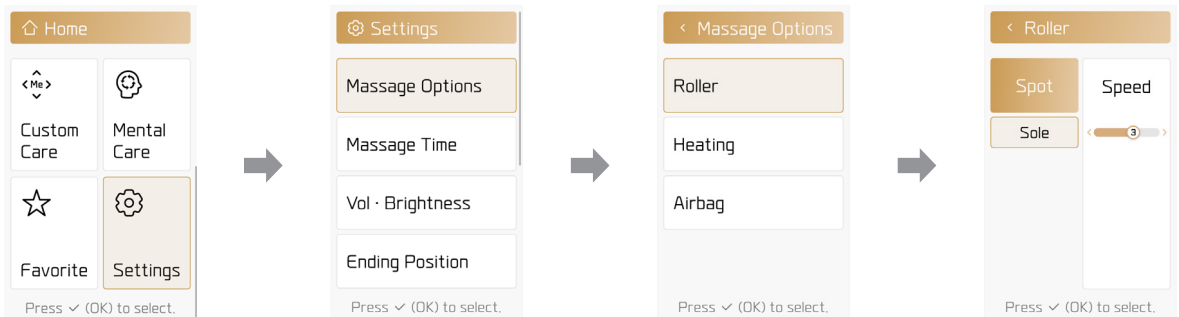

# Controller Operation Descriptions

## Heating

Home > Settings > Message Option > Heating > Select the location and adjust the intensity among 0~3 levels

※ Heating is limited to where heating wires are applied.

※ To prevent low-temperature burns, after 20 minutes of Level 3 heating intensity, it is automatically reduced to Level 2.

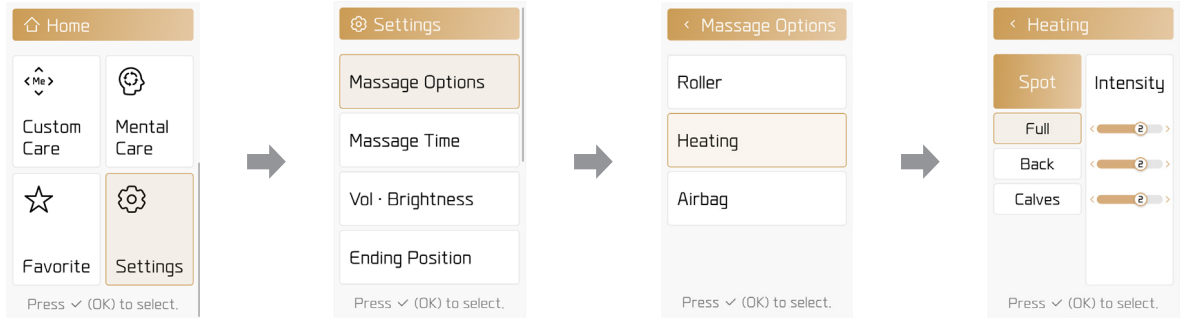

## Airbag

Home > Settings > Message Option > Airbag > Select the location and adjust the intensity among 0-5 levels

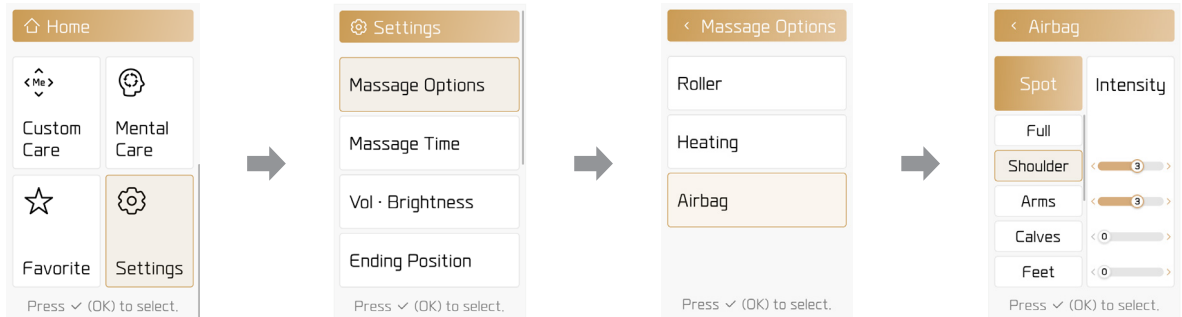

## Message time

Home > Settings > Message Time > Select the message time among 10/20/30 minutes

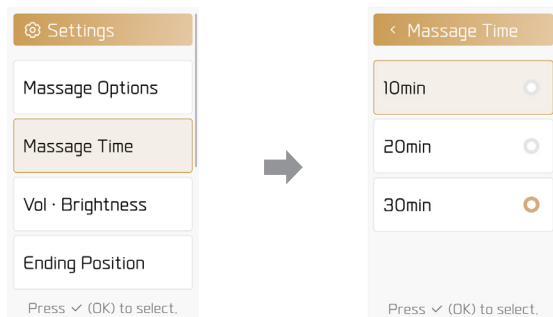

## Vol · Brightness

Home > Settings > Vol · Brightness > Select the Speaker and Controller Volume, Brightness

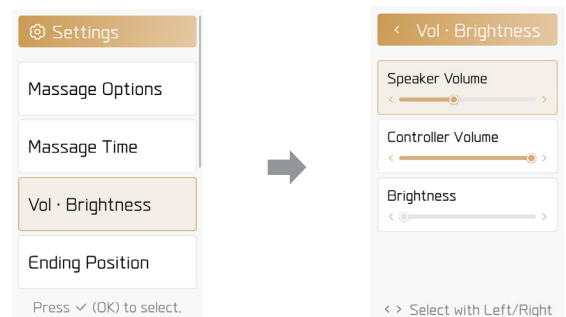

# Controller Operation Descriptions

## Ending Position

Home > Settings > Ending Position > Select the Fixed Position and sit

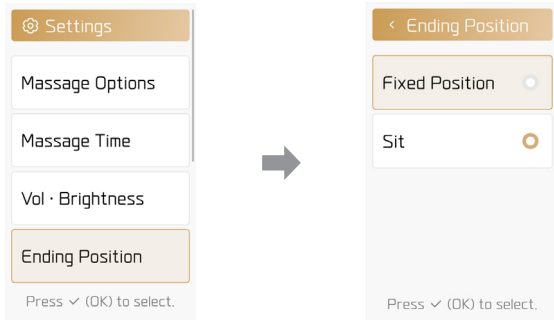

## Roller Config.

Home > Settings > Roller Config. > Select the Roller location and Width / XD Intensity Level Settings > Save

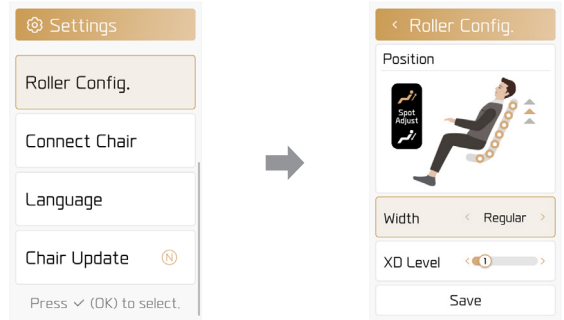

## Connect Chair

Home > Settings > Connect Chair > Wi-Fi and Bluetooth Settings

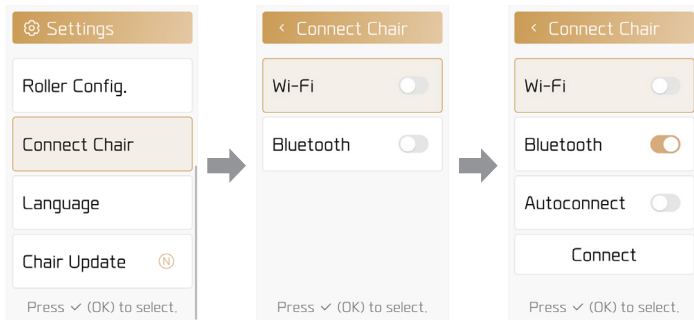

### ※ How to Set up Bluetooth

- 01 Home > Settings > Select Bluetooth
- 02 Select Connect and [OK button]
- ※ When autoconnect is ON and the message chair turns on, it will automatically connect to the last-connected device.
- 03 Mobile devices - Activate Bluetooth Connection > Find BLUETOOTH Devices > Connect FALCON
- ※ Name: FALCON-####
- ※ #### is a unique Bluetooth number of the product. If there are various message chairs in one area, please check the serial number before connecting.

## Language

Home > Settings > Language > Select Language

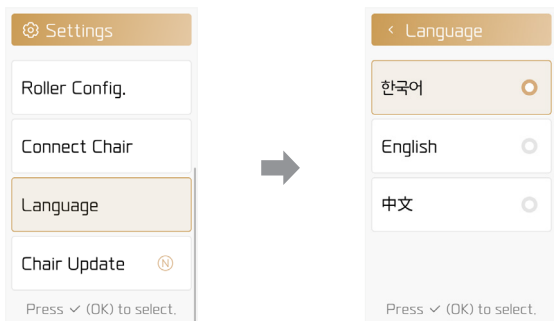

## Chair Update

Home > Settings > Chair Update

※ Please select ON for the Wi-Fi settings to update to the latest software.

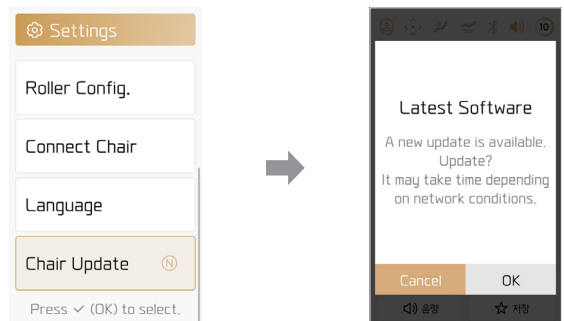

---

# ROVO Care | Health Care

## ROVO Care

---

Home > ROVO Care > Select a mode and press the [OK button] > Sense body and adjust shoulders > Start massage

<b>Iliopsoas Relaxation</b>	Relaxes the core muscles with static stretches.
<b>Cycle Mode</b>	Boosts the flexibility of the lower body by relaxing muscles around the knees and hip joints with cycling movement.
<b>Full Body Stretch</b>	A massage course that supports the back of the head and pulls the lower extremities along with a massage around the spine to strongly stretch the spine.
<b>Legs-Hip Stretch</b>	Strongly stretches the lower body by supporting the pelvis and pulling the legs.
<b>Piriformis Relaxation</b>	Boosts flexibility by relaxing muscles on the back of the buttocks.
<b>PNF Stretch</b>	Combines the relaxation of muscles in the lower body and muscle exercises concurrently. ※ PNF stretch mode applies slight force to induce muscle relaxation. Follow the voice instruction and do not apply excessive force to the massage chair.
<b>Rovo Refresh</b>	Kneads and applies acupressure to the areas where fatigue is built up, providing vitality and energy.
<b>Rovo Recovery</b>	Boosts the flexibility of the legs by gently applying acupressure focused on the neck and waist.

 **The elderly and pregnant women should refrain from using stretching mode.**

## Health Care

---

Home > Health Care > Select a mode and press the [OK button] > Sense body and adjust shoulders > Start massage

<b>Nape Tension Relief</b>	Relaxes and focuses on four muscles attached to the occipital bone and back of the neck.
<b>Relaxed Waist</b>	A massage course that gently relaxes your back and waist.
<b>Hangover Relief</b>	Massages the key acupuncture points for a hangover cure.
<b>Full body Relaxation</b>	A massage course that provides acupressure to the whole body and provides comfortable relaxation.
<b>Spin Mode</b>	Acupressure along the spine line centered on the back and waist.
<b>Swelling Relief</b>	Helps blood circulation and reduces swelling by using full-body airbags.

---

# Parts Care | Daily Care | Mental Care

## Parts Care

---

Home > Parts Care > Select a mode and press the [OK button] > Sense body and adjust shoulders > Start massage

<b>Full Body</b>	Bodyfriend's full body massage course that helps with proper posture and muscle relaxation.
<b>Neck · Shoulders</b>	Relaxes neck and shoulders via kneading and stretching.
<b>Waist · Butt</b>	Relaxes back and buttocks areas through pressure and kneading.
<b>Feet · Legs</b>	An intensive leg massage course in various styles.

---

## Daily Care

---

Home > Daily Care > Select a mode and press the [OK button] > Sense body and adjust shoulders > Start massage

<b>Deep Sleep</b>	Induces sleep via soft and simple full-body massage and angle variation for 30 minutes.
<b>Sport</b>	This course relieves fatigue by strongly stimulating tired arms, legs and soles after exercise.
<b>Good Morning</b>	Perfect course in the morning to refresh your sleepy body.
<b>After-meal</b>	This course is for intestinal health after eating by massaging beneficial stimulating points for the intestines and around the buttocks.
<b>Student Care</b>	Intensive neck and back massage course for students who are tired after a busy day.
<b>Student Relaxation</b>	Relaxation massage course for students who are stressed from exams.
<b>Student Rest</b>	Massage course designed to help exhausted students rest and get sleep.
<b>Student Stretch</b>	Full-body stretching for students who are tired after a busy day.

---

## Mental Care

---

Home > Mental Care > Select a mode and press the [OK button] > Sense body and adjust shoulders > Start massage

<b>Consolation</b>	Healing massage course that provides messages that empathize with and comfort you.
<b>Breathe Control</b>	A breath control massage course that relaxes you with narration accompanied by classical music.
<b>Imagery Mode</b>	This course is for those who want to freely imagine their own getaway with XD mental imagery sound.
<b>Joy of Immersion</b>	This course provides rest and recharges the fatigued mind and body due to studies and work.

---

---

# XD Module Description

## BODYFRIEND's exclusive new XD massage system

---

### 1. An advanced massage with two to four massage balls alternating according to the body part

- Provides an optimized massage for your aching waist with four massage balls focusing on it.
- Provides an intense massage with two massage balls concentrating on your knotted shoulders.

### 2. Wide and Deep XD Massage

- Provides a kneading massage for a wider area using the long axis of rotation of the XD module.
- Massage balls provide a sophisticated and deep massage while drawing an X pattern.

### 3. Ergonomic XD Massage Angle

- Adjust the angle depending on the massage technique for a more focused massage on body parts.
- Provide strong massage for big muscles and gentle massage for small muscles.
- Realize similar angles of massage conducted by a real massage therapist.

## XD Solid Dual Structure Massage

---

A customization system in which the massage intensity can be changed for each individual's taste.

**Blue, five levels** - Provides an optimized massage by adjusting the intensity of each level of the XD module.

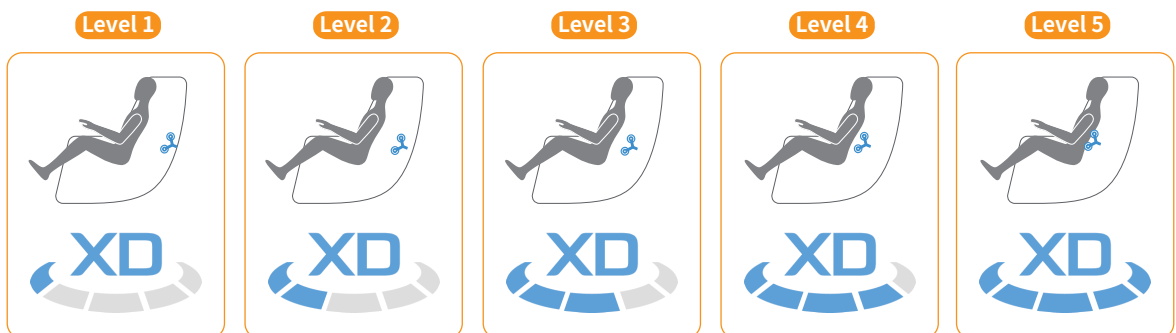

---

## Product Size and Specifications

For performance improvement, the specification may partially change without previous notice.

<b>Model</b>	BFR-7212US
<b>Rated Voltage</b>	110-120 V, 60 Hz
<b>Rated Current</b>	150 W
<b>USB</b>	5 V, 3 A
<b>Auto Timer</b>	10/20/30 minutes
<b>Airbags</b>	Shoulders / Arms / Calves / Top Of Feet / Heels
<b>Rollers</b>	Soles
<b>Massage Ball Range</b>	Neck - buttocks
<b>Remote Controller</b>	4 inch
<b>Speaker</b>	2 ch, 6 W
<b>Product Weight</b>	224.9 lb (102 kg)
<b>User Maximum Weight</b>	221 lbs (100 kg)
<b>Upright</b>	61.4(Length) X 29.5(Width) X 45.7(Height) in (156 X 75 X 116 cm)
<b>Reclined</b>	71.2(Length) X 29.5(Width) X 33(Height) in (181 X 75 X 84 cm)
<b>General Name</b>	Electric Massager



# Customer Support Guidelines

If you encounter minor malfunctions or errors, please refer below before contacting the customer center.

Problem	Cause	Solution
<b>Message chair does not operate</b>	Did not press the Power button on the controller or inner key	Press the Power button
	Program is not selected	Select and run the program
	Power is not properly plugged in	Properly plug the power into the socket
	Power plug/cable is damaged	Please contact the after-service center
	Fuses is burnt	
	Electrical circuit is malfunctioning	
<b>Message chair makes noise during use</b>	General machine noise - Air pump vibration, air inlet/outlet noises - Noise due to airbag inflation - Solenoid valves opening/closing - Sheet friction	The noise is general machine noise. There is nothing wrong with the product
	Used the massage chair for a long time	Restart the machine (after 30 min)
	Tear from long-time usage	Please contact the after-service center
<b>Machine suddenly stops during the operation</b>	Accidentally pressed the OFF button	Press the Power ON button
	Massage time has ended	Restart the machine (after 30 min)
<b>Machine suddenly stops during angle change</b>	Check the object detection sensors and whether there are any objects caught between parts	Remove the object and restart the machine
	Excessive usage or shock	Restart the machine (after 30 min)
<b>Massage balls caught or crashed into the interior sheet during the operation</b>	Frictions between the massage balls and sheets	Rubdown technique generates such a phenomenon due to massage balls so it's not a problem
<b>Does not go back to the original position</b>	Excessive use	Please contact the after-service center
<b>Overheated controller</b>	Use the massage chair for a long time	Restart the machine (after 30 min)
<b>Overheated power cable</b>	Excessive load	Restart the machine (after 30 min)
	Other miscellaneous causes	Please contact the after-service center
<b>Airbags do not activate</b>	Air hose disconnected	Please contact the after-service center
	Air-related power cord is disconnected	

---

# Warranty Terms and Conditions

## Covered

- All parts, labor, and framework of the chair
- Labor and parts covered for the first three years at no cost to Purchaser
- Structural Framework covered at no cost to Purchaser for all five years
- Defects in materials and workmanship

All goods sold hereunder, except accompanying accessories, documentations, or enhancements, are warranted to be free from defects in material and workmanship at the time of delivery to Purchaser and covered for the above, for a period of five (5) years from the date of delivery.

Defective material may be returned to BODYFRIEND after inspection by an agent of BODYFRIEND and upon receipt from BODYFRIEND of shipping instructions specific to the defective goods authorized by BODYFRIEND to be returned.

Goods returned in accordance with the foregoing procedure will be replaced or repaired, at the option of BODYFRIEND, and returned to Purchaser without charge.

This warranty is subject to the following LIMITATIONS AND EXCLUSIONS :

## Limitations

- This express warranty applies to massage chairs ONLY, and not to accompanying accessories, documentation or enhancements;
- This warranty is non-transferable;
- This warranty is valid only within CANADA;
- BODYFRIEND's responsibility and Purchaser's exclusive remedy under this warranty is limited to the repair or replacement of defects in material and workmanship, as set forth above. BODYFRIEND is not responsible for any consequential damages resulting from the breach of this or any other express or implied warranty with respect to the goods;
- This express warranty is the only warranty applicable to this transaction. It excludes all other express oral or written warranties and all warranties implied by law with respect to the goods, including any warranties of merchantability or fitness for a particular purpose;
- This warranty does not extend to any of BODYFRIEND's products which have been subject to misuse, accident or improper installation or storage, maintenance or application, nor does it extend to products which have been repaired or altered outside of BODYFRIEND or its authorized agents, nor does this warranty extend to any labor charges for removal and/or replacement of the nonconforming or defective product or part thereof;
- Every claim under this warranty or related to this purchase order shall be deemed waived by Purchaser unless made in writing within five (5) years of the receipt of the goods to which such claim relates; AND
- This warranty is void in the event that repairs are made by anyone other than BODYFRIEND without prior authorization from BODYFRIEND.  
The terms of this warranty shall be governed by the laws of CANADA.

---

# Warranty Terms and Conditions

## Exclusions

This express warranty is void without this warranty card and requested information (date of purchase, installation, RMA, etc.).

This express warranty does not cover damage resulting from improper installation or use, neglect, dropped product, unreasonable maintenance, failure to follow instructions, unauthorized repairs, alterations, modifications of original condition, and cosmetic alternations. Furthermore, warranty does not cover damage resulting from improper use of electrical/power supply; loss of power; electrical disturbances, power surges.

Also, damage or cracked screen because of personal misuse, excessive force, transportation damage, theft, abuse, misuse, vandalism, or natural disasters (fires, floods, rust, corrosion, sand, dirt, windstorms, hail, earthquakes, or any exposure to weather conditions) are not covered under stated warranty. BODYFRIEND does not honor warranty for products purchased by or through unauthorized dealers, product used commercially or for commercial purposes, and time lost by owner during the time the product is being replaced, at a repair facility, etc. Natural occurrences such as, but not limited to softening/hardening of foams and composites, fading, wear, pilling of fabrics, natural markings, grain and dye variations in leather, and failure of attach points does not validate issue of warranty, as well as items intended to be periodically replaced by Purchaser during the normal lifetime of a product including, but not limited to batteries, light bulbs, and etc. Seat cover replacement and other accessories are not covered under warranty.

## Labor

Only for the first three years of the warranty period (“Labor Service Period”), BODYFRIEND will provide labor services for the repair or replacement of defective parts at no cost to Purchaser. However, Purchaser is responsible for all shipping, duties, and brokerage fees.

Upon expiration of the Labor Service Period, Purchaser shall pay for any labor service charges.

Labor services are limited to the replacement of the defective product or parts with a similar product of equal or less value. If replacement is not accepted by Purchaser, BODYFRIEND or its labor service provider is no longer responsible for further service under this labor warranty. If and only when deemed necessary at its sole discretion, BODYFRIEND will send a service provider at no cost. Field service is only available within CANADA and under the Labor Service Period. If no problem is found upon diagnosis, Purchaser may be charged with standard rate for unnecessary service calls.

\*Listed years vary by product

**BODYFRIEND**  
**855-200-3524**  
**[service@bodyfriend.com](mailto:service@bodyfriend.com)**

# FALCON·SV

---

**Product Name**      Electrical massager  
**Model**                BFR-7212US  
**Customer Service**    562-991-5546  
**Manual Number**      240329

**⚠ WARNING:** This product can expose you to chemicals including RoHS (Pb, Cd), which is known to the State of California to cause cancer, birth defects or other reproductive harm. For more information, go to: [www.P65Warnings.ca.gov](http://www.P65Warnings.ca.gov)

**♻** Please remove this manual according to the local separate waste collection rules.

