

dyson airstrait

User manual



Contents

In the box

Getting started

Using your straightener

Settings

Cleaning your machine

Cleaning the filter

Cleaning the tension bars

Cleaning the diffusers

Deep cleaning the filter

Alerts

In the box



Dyson Airstrait™ straightener
Wet to dry straightening, with air.
No hot plates. No extreme heat.¹
Uses high-velocity air, not hot
plates. Straightens from wet to dry.
Engineered to create a natural
straight finish.



Velvet heat mat / Non-slip heat mat
For safe placement during and
after styling.

1. When used in wet to dry mode.

Getting started

Unlock

Open the machine's arms by sliding the lock button down.

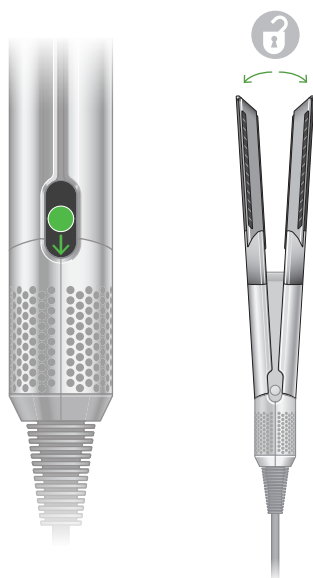

LCD Screen

Displays airflow and temperature settings.



Temperature control

Five precise temperatures for wet or dry styling, plus optional Boost mode.



Airflow control

Two speed settings, low flow and high flow.



Cool mode

Use to set your style.



Mode select

Style from wet or dry.



Power On/Standby

Tension bars

Help control and add tension to the hair within the arms.

Diffusers

Gently diffuse airflow when close to the skin, for comfortable styling.

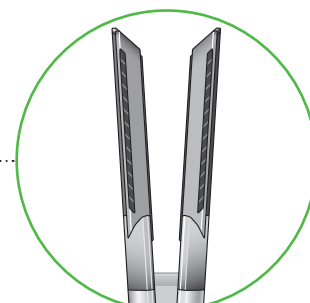

Lock button

Slide button to lock and unlock arms.



Filter

Removable filter.

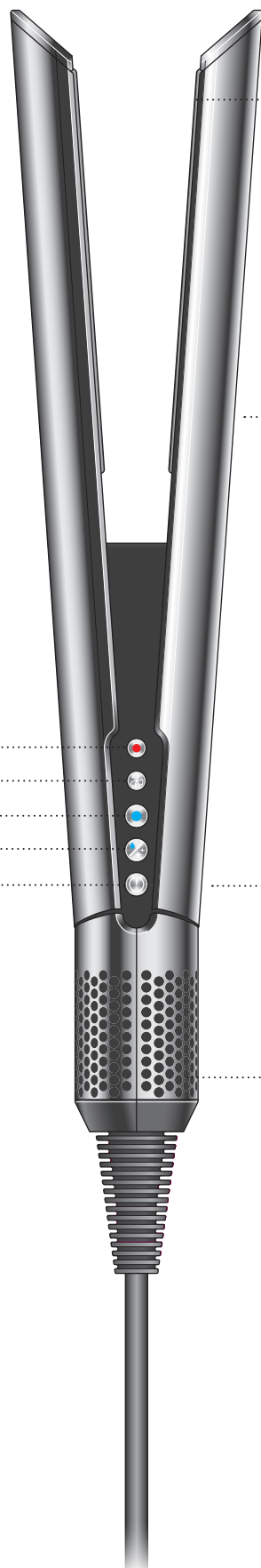

Using your straightener



Your straightener is designed to be used with towel-dried hair, not dripping wet hair. Once towel-dried, detangle your hair with a brush or comb.

Your straightener should never be used without the fan motor on.

Straightening from wet

Before starting to straighten your hair, dry your roots with the arms of your straightener closed. You can use your straightener with the arms locked or just hold them closed.

For the optimum experience, use maximum airflow and a higher temperature, and direct the airflow towards your roots.

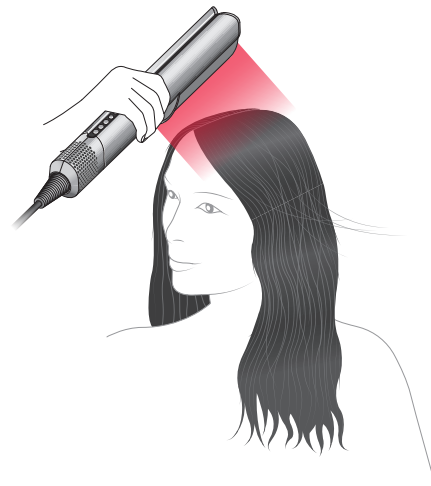

Unlock the arms and use the Mode select button to set your straightener to Wet mode.

Your straightener will give you a choice of temperatures that you can change according to your hair type and styling preference. Use lower temperatures for finer hair, and higher temperatures for thicker hair.

Hold your straightener so that the airflow is directed downwards and start to pass sections of hair through the arms. Repeat until each section is dry. Change the airflow and temperature settings as required.

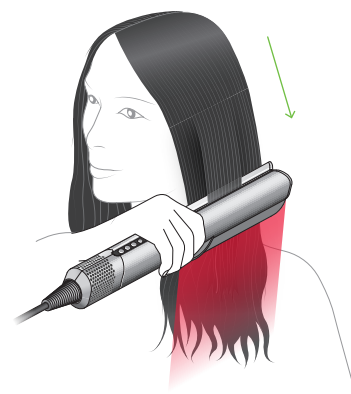

Refresh from dry

Use Dry mode only to refresh your style.

Unlock the arms and use the Mode select button to set your straightener to Dry mode.

In Dry mode, your straightener has a choice of temperatures and an additional Boost when needed.



Cool mode

Use Cool mode to set your style. Hold your straightener with the arms shut and direct the airflow down the hair section to smooth and set.



Adjusting the temperature

Press the Temperature control button to change the setting for your hair type and styling preference.

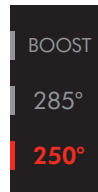
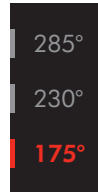

Boost

Select Boost when styling dry hair for a shot of extra heat.

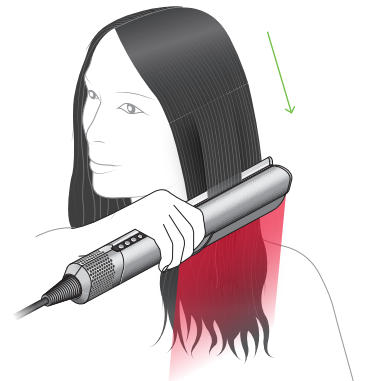

Adjusting the airflow

Press the Airflow button to toggle between high and low airflow.



Idle mode

Between passes, your straightener will activate Idle mode. Airflow will reduce, then increase as soon as you close the arms.

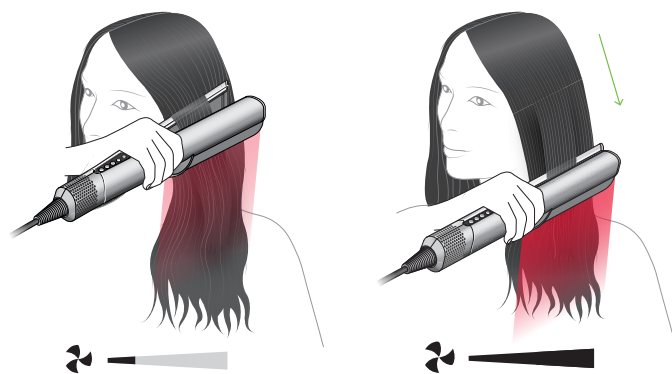

Auto pause

To save energy, your straightener will Auto pause when left for three seconds with the arms open. It will activate again when you pick it up.



Stand-by

To save energy, your straightener will go into standby if left unattended with the arms open for more than three minutes. Press the Power button to re-activate.

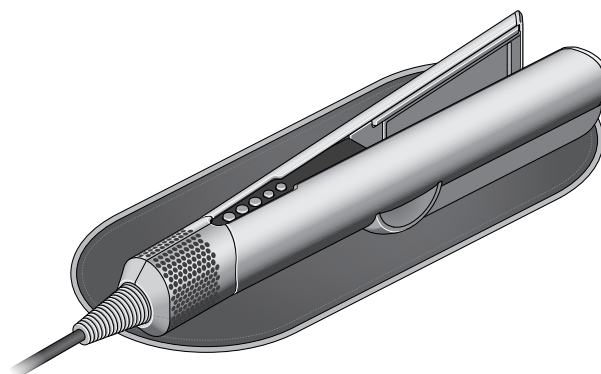

Go to www.dyson.com/hair-care/hair-straighteners/airstrait for styling tips and guides.



Idle mode may cause lights to dim

High power appliances, such as your Dyson Airstrait™ straightener, may cause lights in your home to flicker or dim. They draw more electricity, which temporarily takes power away from other appliances on the same circuit.

If light dimming occurs when using your straightener, try plugging in to a different outlet and circuit. A professional can help to identify suitable outlets.

Settings

Your Dyson Airstraii™ straightener has a settings menu to help you customize your machine to your usage. Press and hold the Mode select button to access the menu on the LCD screen.



Idle mode

You can enable or disable Idle mode on your machine.

Press and hold the Mode select button on your straightener until the menu appears.

Press the Cool mode button to toggle between on and off.

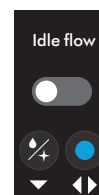

Auto pause

You can prevent your straightener from Auto pausing.

Press and hold the Mode select button on your straightener until the menu appears.

Use the Mode select button to scroll through the menu options. Press the Cool mode button to select and press again to toggle between on and off.



Units

Press and hold the Mode select button on your straightener until the menu appears.

Press the Cool mode button to toggle between °C and °F.



Language

Press and hold the Mode select button on your straightener until the menu appears.

Press the Mode select button to scroll through the language options.

Press the Cool mode button to select the language you want and then press again to confirm. A tick will appear on the screen to confirm your selection.

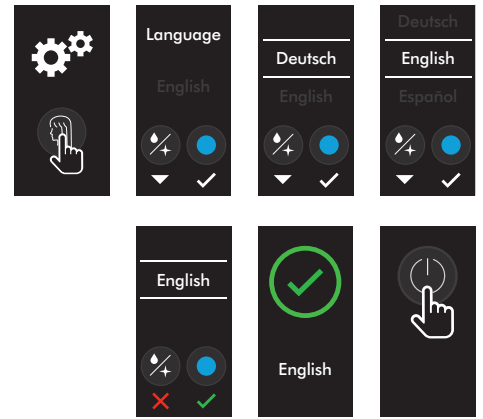

Factory reset

Press and hold the Mode select button on your straightener until the menu appears.

Press the Cool mode button to start a factory reset.

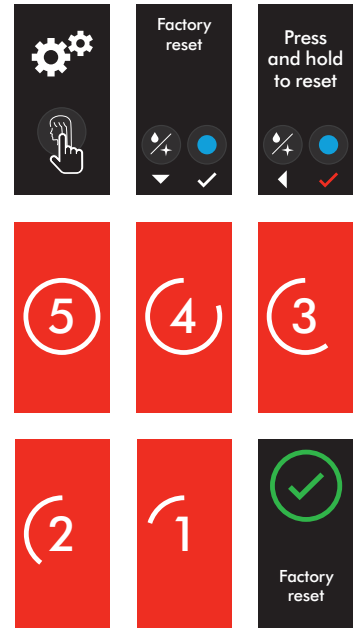

Exit

Use the Mode select button to scroll through to the Exit screen and press the Cool mode button to select.

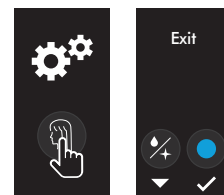

Cleaning your machine

Your straightener has been precisely engineered. To maintain outstanding styling performance, it needs to be kept free from hair product residue and debris. A little regular maintenance will optimize performance.

Cleaning the filter

Remove the filter

Unplug your straightener and let it cool down before cleaning your filter.

Hold the body of your straightener with one hand and the perforated filter unit with the other. Pull down on the filter unit to release it from the machine and onto the cable.

Gently pull the filter open and slide it off the cable.



Wash the filter

Leave the filter unit to soak in warm, soapy water for at least 30 minutes. We recommend using a clarifying shampoo or dish soap.

Using your fingertips, rub gently to thoroughly clean both the inside and outside surfaces of the filter.

Shake off excess water and leave for 24 hours in a well-ventilated place until completely dry.

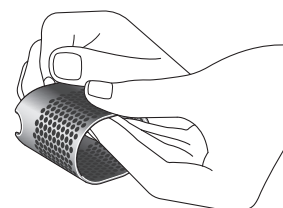
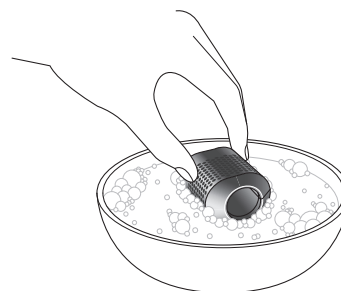

Replace the filter

Pull the filter open and slide it onto the cable.

Slide the filter unit towards the machine body, align and click into place.

Your straightener will alert you if the filter isn't in place correctly.

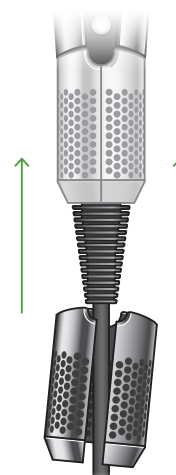

Cleaning the tension bars

Over time, hair product residue may build up on the tension bars. These bars sit at the top of the inside of each arm and it's important to keep them clean and free from debris.

Use a soft-bristled toothbrush and a small amount of warm water to brush away any debris. Dry with a clean, lint-free cloth.

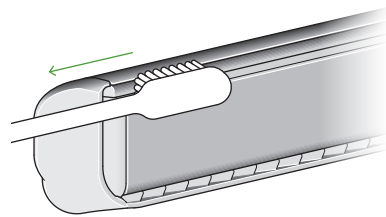

Cleaning the diffusers

The diffusers are attached to the sides of the straightener's arms. We recommend these are kept clean, free from debris and hair product residue. This will keep them functioning effectively.

Ensure machine is switched off then slide the diffusers off the ends of the arms. Use a damp, lint-free cloth to remove any debris and hair product residue. You can also use a soft-bristled toothbrush to remove any stubborn residue.

Refit the diffusers to the arms once clean and fully dry. We recommend that you don't use your straightener without the diffusers attached.

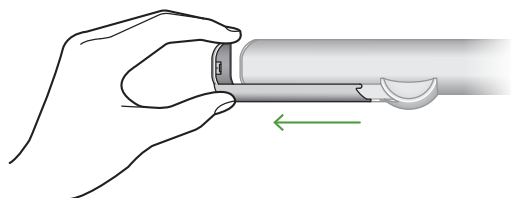

Deep cleaning the filter

If the filter becomes blocked, you can deep clean it.

Remove filter unit

Unplug your straightener and let it cool down before cleaning your filter.

Hold the body of your straightener with one hand and the perforated filter unit with the other. Pull down on the filter unit to release it from the machine and onto the cable.

Gently pull the filter open and slide it off the cable.

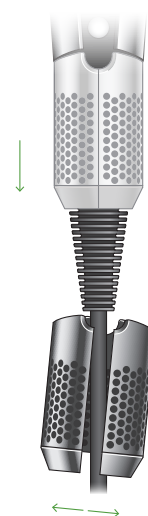
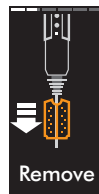

Wipe filter mesh

Wipe the filter mesh with a dry, lint-free cloth to remove any debris.

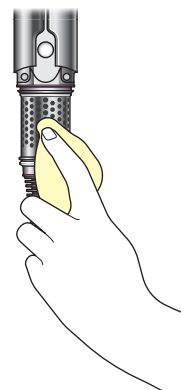

Soak filter unit

Leave the filter unit to soak in warm, soapy water for at least 30 minutes. We recommend using a clarifying shampoo or dish soap.

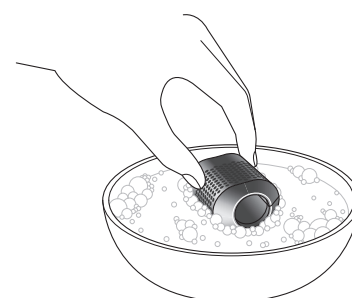

Remove inner filter

Remove from the filter cage.

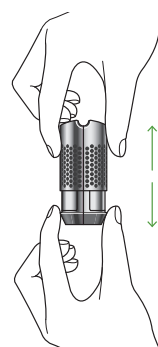

Rub gently, rinse, then dry

Using your fingertips, rub gently to thoroughly clean each part. Rinse both parts of the filter unit to remove any debris.

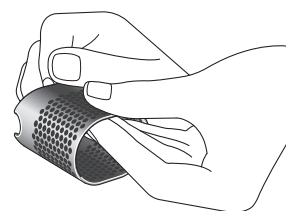

Allow both parts of the filter unit to air-dry completely or gently wipe with a lint-free cloth.

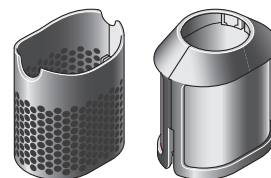

Replace inner filter

Check that all debris has been removed before replacing the inner filter in the filter cage.

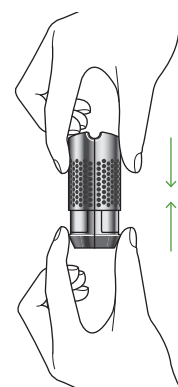

Replace filter unit

Pull the filter open and slide it onto the cable.

Slide the filter unit towards the machine body, align and click into place.

Your straightener will alert you if the filter isn't in place correctly.

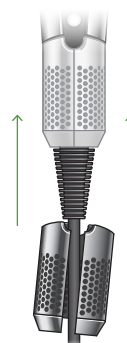

Alerts

Clean filter

You can continue to use your straightener but we recommend you clean the filter for optimum performance.

Scan the QR code on the screen to help fix this alert or follow the Cleaning your filter instructions above.



Filter blocked

Your straightener won't operate until the filter is cleaned.

Scan the QR code on the screen to help fix this alert or follow the Cleaning your filter instructions above.

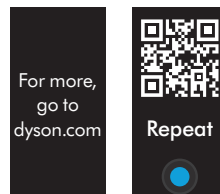
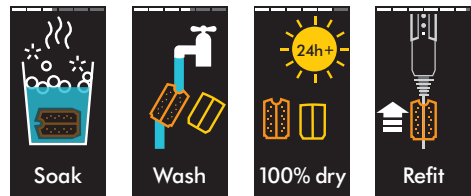
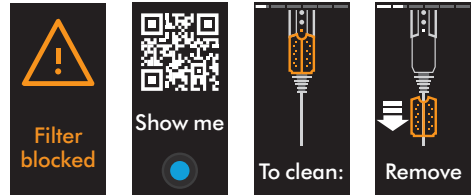

No filter

The filter isn't fitted correctly or is missing. Your straightener won't operate until fitted.

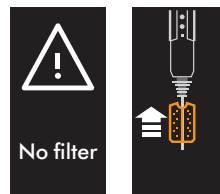

Contact Dyson

There is a fault with your straightener. Please contact Dyson.



Volt alert

Your machine has either been plugged into a power source with the incorrect voltage or the voltage is fluctuating.

Plug into a stable, compatible power supply.



Too hot

Your straightener has become too hot and will need to cool down.

Turn off your straightener, unplug and leave to cool down.



Reset

Your straightener has an error. Press the Power button to turn off your straightener and then turn it on again.

If this doesn't clear the alert, turn off your straightener and unplug from the power source. Plug in and turn on again.

