



FORNO[®]
Espresso



INDUCTION RANGE
MODEL NUMBER SERIES

FFSIN0982-30 | FFSIN0982-30BLK | FFSIN0982-30WHT

INSTRUCTION MANUAL

Read these instructions carefully before using your appliance, and keep it carefully.
If you follow the instructions, your appliance will provide you with many years of good service.

TABLE OF CONTENTS

Customer Care	4
Warning	5
Important Safety	7
Name Of Parts	8
Control Panel	9
Operating Instruction	
• Cooktop Use	9
• Oven Use	11
• Preheating	11
Oven Modes:	
• Bake	12
• Broil	13
Convection Modes:	
• Conv. Bake	14
• Conv. Broil	15
• Conv. Roast	15
Range Care	
• Cleaning	17
• Oven Door Removal	18
• Oven Light Replacement	19
Troubleshooting	20
Warranty	23

INDUCTION RANGE

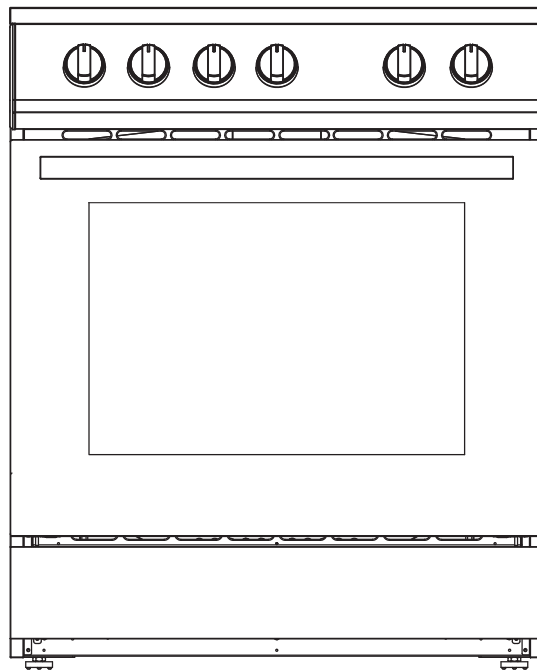

MODEL NUMBER SERIES

FFSIN0982-30 | FFSIN0982-30BLK | FFSIN0982-30WHT

Customer Care

Thank you for purchasing a Forno product. Please read the entire instruction manual before operating your new appliance for the first time. Whether you are an occasional user or an expert, it will be beneficial to familiarize yourself with the safety practices, features, operation and care recommendations of your appliance.

Both the model and serial number are listed inside the product. For warranty purposes, you will also need the date of purchase .

Record this information below for future reference.

Product Information

Model Number: _____

Serial Number: _____

Date of Purchase: _____

Purchase Address And Phone: _____

Service Information

Use these numbers in any correspondence or services calls concerning your product.

If you received a damaged product, immediately contact Forno.

To save time and money, before you call for serviced, check the troubleshooting guide. It listed the causes of minor operation problems that you can correct yourself.

Model And Serial Number Location

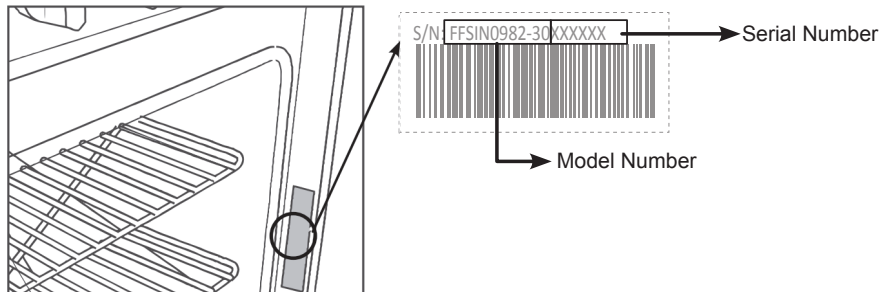

Services in Canada and Untied States

Keep the instruction manual handy to answer your questions. You can also find all the information you need online at www.forno.ca.

If you don't understand something or need more assistance, please visit our website or email: info@forno.ca

If there is a problem, please contact FORNO customer service. Please note that troubleshooting with a customer service representative will be needed before being able to send a service provider. All warranty work needs to be authorized by FORNO customer service. All our authorized service providers are carefully selected and rigorously trained by us.



WARNING FOR YOUR SAFETY

Your safety and the safety of others are very important.

We have provided many important safety messages in this manual and on your appliance. Always read and obey all safety messages.



This is the safety alert symbol. This symbol alerts you to potential hazards that can kill or hurt you and others. All safety messages will follow the safety alert symbol and either the word “DANGER,” “WARNING” or “CAUTION.” These words mean:



- You can be killed or seriously injured if you don't **immediately** follow instructions.



- You can be killed or seriously injured if you don't follow instructions.



- A potentially hazardous situation which, if not avoided, could result in minor or moderate injury.

All safety messages will tell you what the potential hazard is, tell you how to reduce the chance of injury, and tell you what can happen if the instructions are not followed.



WARNING : This product can expose you to chemicals including [Lead, lead and lead compound, which is [are] known to the state of California to cause cancer and birth defects or other reproductive harm. For more information go to www.P65Warning.ca.gov.



WARNING
FOR YOUR SAFETY

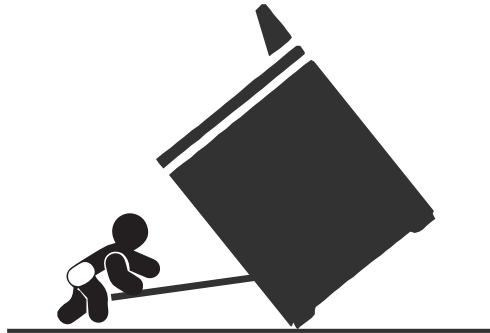

Tip Over Hazard

- A child or adult can tip the range and be killed.
- Install anti-tip bracket to floor or wall per installation instructions
- Slide range back so rear range foot is engaged in the slot of the anti-tip bracket.
- Re-engage the anti-tip bracket if range is moved.
- Do not operate the range without anti-tip bracket installed and engaged.
- Failure to follow these instructions can result in death or serious burns to children and adults.

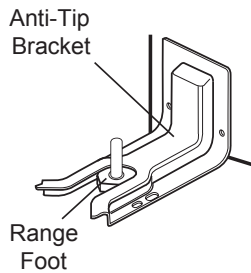

Making sure the anti-tip bracket is installed:

- Slide range forward.
- Look for the anti-tip bracket securely attached to floor and wall
- Slide range back so rear range foot is under anti-tip bracket.

Important Safety Instructions

WARNING: To reduce the risk of fire, electrical shock, injury to persons, or damage when using the range, follow basic precautions, including the following:

• **WARNING:** TO REDUCE THE RISK OF TIPPING OF THE RANGE, THE RANGE MUST BE SECURED BY PROPERLY INSTALLED ANTI-TIP DEVICES. TO CHECK IF THE DEVICES ARE INSTALLED PROPERLY, SLIDE THE RANGE COMPLETELY FORWARD, LOOK FOR THE ANTI-TIP BRACKET SECURELY ATTACHED TO THE FLOOR BEHIND THE RANGE, AND SLIDE RANGE COMPLETELY BACK UNTIL THE REAR RANGE FOOT IS UNDER ANTI-TIP BRACKET.

- **WARNING:** NEVER use this appliance as a space heater to heat or warm the room. Doing so may result in carbon monoxide poisoning and overheating of the oven.
- **WARNING:** NEVER cover any slots, holes, or passages in the oven bottom or cover an entire rack with materials such as aluminum foil. Doing so blocks airflow through the oven and may cause carbon monoxide poisoning. Aluminum foil linings may also trap heat, causing a fire hazard.
- **CAUTION:** Do not store items of interest to children in cabinets above a range or on the back guard of a range –children climbing onto the range to reach items could be seriously injured.
- **DO NOT LEAVE** Children Alone –Children should not be left alone or unattended in areas where the range is in use. They should never be allowed to sit or stand on any part of the range.
- **Wear Proper Apparel** – Loose-fitting or hanging garment should never be worn while using the range.
- **User Servicing** – Do not repair or replace any part of the range unless specifically recommended in the manual. All other servicing should be referred to a qualified technician.
- **Flammable materials** should not be stored in an oven or near surface units.
- **DO NOT USE WATER** on Grease Fires – Smother fire or flame, use a dry chemical or foam-type extinguisher.
- **Make sure your pot holders are dry.** – Moist or damp pot holders on hot surfaces may result in burns from steam. Do not let pot holder touch hot heating elements. Do not use a towel or other bulky cloth.
- **DO NOT TOUCH SURFACE UNITS OR AREAS NEAR UNITS** – Surface units may be hot even though they are dark in color. Areas near surface units may become hot enough to cause burns. During and after use, do not touch, or let clothing or other flammable materials contact surface units or areas near units until they have had sufficient time to cool. Among those areas are the cook top and surfaces facing the cook top.
- **Never Leave Surface Units Unattended at High Heat Settings** – Boil over causes smoking and greasy spillovers that may ignite.
- **Glazed Cooking Utensils** – Only certain types of glass, glass/ceramic, ceramic, earthenware, or other glazed utensils are suitable for range-top service without breaking due to sudden temperature changes.
- **Utensil Handles Should Be Turned Inward and Not**

Extend Over Adjacent Surface Units – To reduce the risk of burns, ignition of flammable materials, and spillage due to unintentional contact with the utensil, the handle of a utensil should be positioned so that it is turned inward, and does not extend over adjacent surface units.

- **Clean Cook top with Caution** – If a wet sponge or cloth is used to wipe spills on a hot cooking area, be careful to avoid steam burn. Some cleaners can produce noxious fumes if applied to a hot surface.
- **CAUTION:** When Opening Door, stand on the side of the range and let the hot air or steam escape before removing or replacing food.
- **Do Not Heat Unopened Food Containers.** - Build-up of pressure may cause the container to burst and result in injury.
- **Keep Oven Vent Ducts** free from obstructions.
- **Oven Racks Placement** – Always place oven racks in the desired location while the oven is cool. If the rack must be moved while the oven is hot, do not let the pot holder in contact with the heated rack.
- **DO NOT TOUCH HEATING ELEMENTS OR INTERIOR SURFACES OF OVEN** – Heating elements may be hot even though they are dark in color. The interior surfaces of an oven become hot enough to cause burns. During and after use, do not touch, or let clothing or other flammable materials in contact with heating element or interior surfaces of the oven until they have had sufficient time to cool. Other surfaces of the appliance may become hot enough to cause burns – among these surfaces are oven vent openings and surfaces near these openings, oven doors, and windows of oven doors.
- **Proper Installation** – The range, when installed, must be electrically grounded by local codes or, in the absence of local codes, with the National Electrical Code, ANSI/NFPA 70. In Canada, the range must be electrically grounded by Canadian Electrical Code. Be sure the range is properly installed and grounded by a qualified technician.
- **Disconnect the electrical supply** before servicing the appliance.
- **Injuries may result from the misuse of appliance doors or drawers** such as stepping, leaning, or sitting on the doors or drawers.
- **Maintenance** – Keep the range area clear and free from combustible materials, gasoline, and other flammable vapors and liquids.
- **For units with ventilating hood**
- **Clean Ventilating Hoods Frequently** – Grease should not be allowed to accumulate on the hood or filter.
- **When flambé cooking under the vent hood, turn the fan on.**

READ AND SAVE THESE INSTRUCTIONS

State of California Proposition 65 Warnings: **WARNING:** This product contains one or more chemicals known to the State of California to cause cancer. **WARNING:** This product contains one or more chemicals known to the State of California to cause birth defects or other reproductive harm.

Names of Parts and Accessories

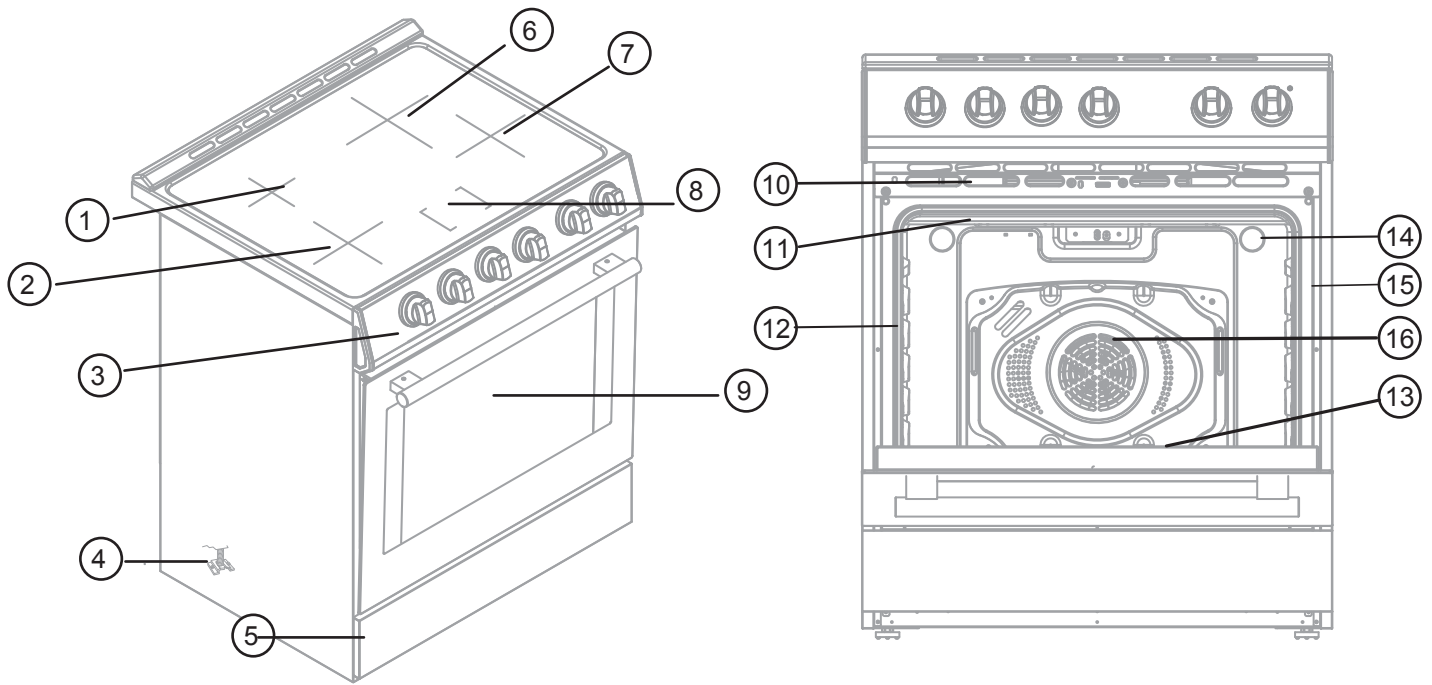

Numbers	Parts	Remark
1	Left Rear Burner: 1200 / 1500W(boost)	Heating area size: 140mm Most suitable pan size: 140-160mm
2	Left Front Burner: 1800 / 2100W(boost)	Heating area size: 185mm Most suitable pan size: 180-200mm
3	Control Panel	NA
4	Anti-tip Bracket	NA
5	Kick Plate	NA
6	Right Rear Burner: 2300 / 3000W(boost)	Heating area size: 185mm Most suitable pan size: 180-200mm
7	Right Front Burner: 1200 / 1500W(boost)	Heating area size: 140mm Most suitable pan size: 140-160mm
8	Hot Surface Indicator Lights	NA

Numbers	Parts
9	Oven Door Window
10	Oven Vent
11	Broil Element
12	Door Gasket
13	Bottom Element (not visible)
14	Oven Light
15	Model and Serial Number Plate
16	Convection Fan

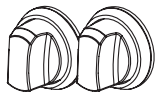

12x Forno Knobs
(Stainless Steel 6x & Antique Brass 6x)

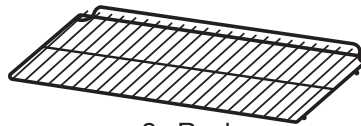

2x Racks

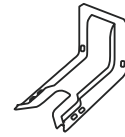

1x Anti-Tip Bracket



12x Bezel
(Stainless Steel 6x & Antique Brass 6x)



1x Backsplash



5x Screws (M4*8)
(For backsplash installation)



2x Forno Door Handle
(Stainless Steel 1x & Antique Brass 1x)



1x Hand tool



2x Screws (M5*45)
(For Anti-tip bracket)

NOTE: Antique brass Handle/Antique brass Knobs only for the White And Black Units.

Control Panel

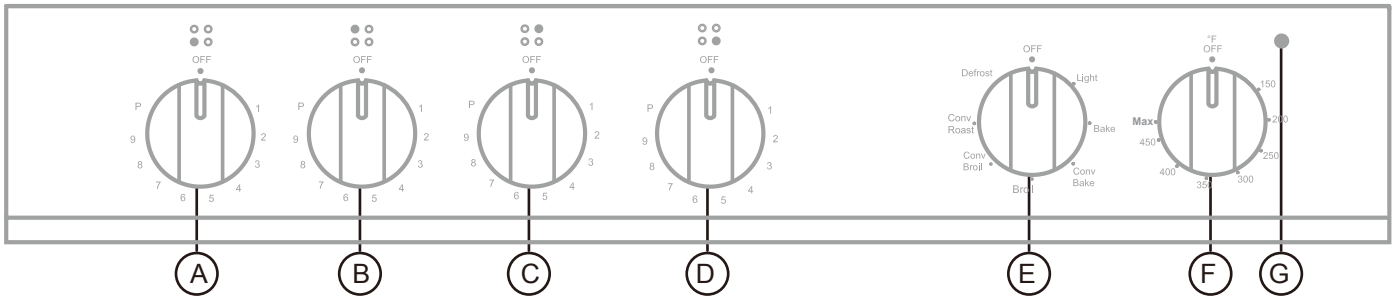

Numbers	Parts
A	Front left burner
B	Rear left burner
C	Rear right burner
D	Front right burner
E	Oven settings
F	Temperature
G	Light indicator

Operating Instructions

COOKTOP USE

1. Place a suitable pan on the cooking zone you wish to use. How to tell if your existing pan can be used for induction range. Place a magnet at the bottom of the pan and pay attention if the magnet sticks to the pan. If so, then the pan is suitable for induction. If the magnet does not stick to the pan, then the pan is NOT suitable for the induction. Note: A non induction pan, will not work on the induction range.
2. Select the heating zone you wish to use. Make sure the bottom of the pan and the surface of the cooking zone are clean and dry. Turn the control knob clockwise.

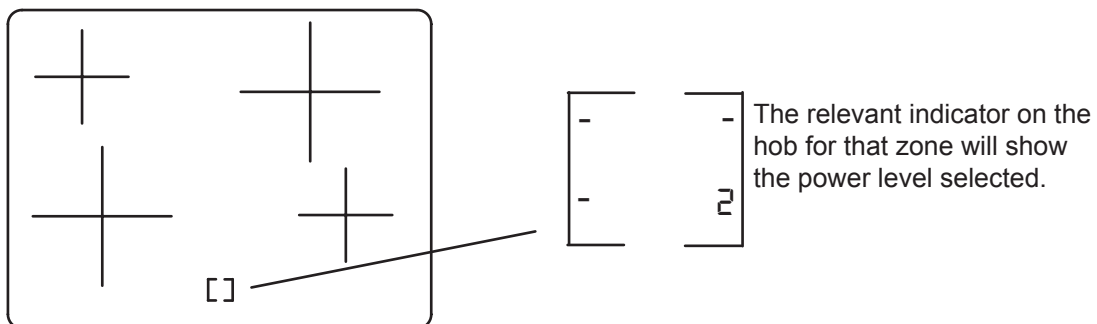

Operating Instructions (continued)

Indicator Icons & Symbols:

Icons & Symbols:	Function
H	"H" is the cooking zone is too hot to touch. It will disappear when the surface has cooled down to a safe temperature.
⏟	The burner is activated but not in use
P	Boost is activated

- Adjust the power level up /down by turning the control knob clockwise/anti-clockwise. The power levels range from 1-9 as well as Boost (P) settings. You can modify the power level at any time..

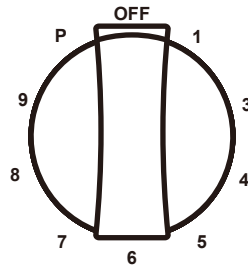

Activating the Boost Function:

- Turn the control knob clockwise all the way to "P". The "P" will be activated and it will display on the indicator. The boost function will remain on for 5 minutes, after that the zone will set to level 9 automatically.
- To cancel the boost function, turn the knob anticlockwise to "9".

Note: you can activate two boost functions at same time, except for the Right Rear Burner (3000W).

IMPORTANT: Clean the cooktop after each use to avoid permanent damage from pitting or scratching to the cooktop surface.

- Make sure the bottoms of pots and pans are clean and dry before using them. Residue and water can leave deposits when heated.
- Avoid storing jars or cans above the cooktop. Dropping a heavy or hard object onto the cooktop could crack the cooktop.
- To avoid damage to the cooktop, do not leave a hot lid on the cooktop. As the cooktop cools, air can become trapped between the lid and the cooktop and ceramic glass could break when the lid is removed.

Operating Instructions (continued)

- For foods containing sugar in any form, clean up all spills as soon as possible. If sugary spills are allowed to cool down, they can adhere to the cooktop and can cause pitting and permanent marks
- Do not slide cookware or bakeware across the cooktop. Aluminum or copper bottoms and rough finishes on cookware or bakeware could leave scratches or marks on the cooktop.
- Do not cook popcorn in prepackaged aluminum containers on the cooktop. They could leave aluminum marks that cannot be removed completely.
- Do not allow objects that could melt, such as plastic or aluminum foil, to touch any part of the entire cooktop.
- Do not use the cooktop as a cutting board.
- Do not cook foods directly on the cooktop.

OVEN USE

This multi-function oven combines the functions of traditional oven modes with the functions of modern, fan-assisted convection modes in a single oven. Use the Cooking feature control knob, located on the control panel, to select the oven mode.

Rack Placement in your oven

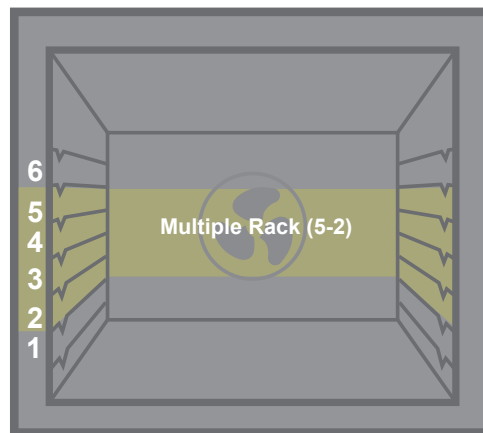

BEFORE USE

1. Make sure the oven is close.
2. Rotate the cooking feature knob to Bake.
3. Rotate the temperature feature knob to 500°F (260°C).
4. Let it operate for 30 minutes NOTE: Allow the oven to operate for 30 minutes with no food in the cavity. Once it did its 30 minutes, open the oven door to allow the oven to cool. Any odor that may be detected during this initial use is due to the evaporation of substances used to protect the oven during storage.
5. IMPORTANT:
Do not place anything, including dishes, foil, and oven trays, on the bottom of the oven when it is in operation to avoid damaging the enamel.

PREHEATING

1. Turn the cooking functions knob to the desired function you wish to use.
2. Rotate the dial to the temperature you wish to use.

Note: The higher the temperature is, the longer it will take to preheat. The actual oven temperature will go higher than your set temperature to offset the heat lost when you open the oven door to place the food on the rack. This ensures that cooking will begin at the proper temperature. Do not open the door while the oven is preheating. When the oven has reached the set temperature, the indicator light on the control panel will turn on. You can then open the door and place food in the oven.

Oven (continued)

OVEN SETTINGS

1. Bake

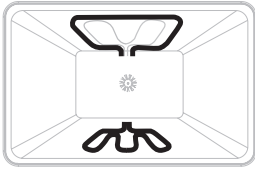

Baking is cooking with heated air. Both upper and lower elements in the oven are used, but the fan is used only during preheating. Follow the recipe or convenience food directions for baking temperature, time, and rack position. Baking time will vary with the temperature of ingredients and the size, shape, and finish of the baking utensil. The temperature can be set from 170°F (77°C) to 500°F (260°C).

- Use one rack when selecting the bake mode.
- On occasion, check the oven to see if your food is done.
- Use metal bakeware (with or without a non-stick finish), heatproof glass, glass ceramic, potter , or other utensils suitable for the oven.
- For best results, bake food on a single rack with at least 1" - 1½" (2.5 - 4 cm) space between bakeware and oven walls.
- When using heatproof glass, reduce temperature by 25°F (15°C) from recommended temperature. Use baking sheets with or without sides or jelly roll pans.
- Dark metal pans or nonstick coatings will cook faster with more browning. Insulated bakeware will slightly lengthen the cooking time for most foods.
- Do not use aluminum foil or disposable aluminum trays to line any part of the oven. Foil is an excellent heat insulator and heat will be trapped beneath it. This will alter the cooking performance and can damage the finish of the oven. You can line a baking tray with foil and use this on the bottom shelf.
- Avoid using the opened door as a shelf to place pans.
- See Troubleshooting for tips on solving baking and roasting problems.

Bake chart Oven Function:

Food Item	Rack Position	Temp. °F (°C) (Preheated Oven)	Time (Min)
Cupcakes	2	350(175)	19-22
Bunt Cake	1	350(175)	40-45
Angel Food	1	350(175)	35-39
Pie 2 crust, fresh, 9"	2	375-400 (190-205)	45-50
2 crust, frozen fruit, 9"	2	375(190)	68-78
Cookies Sugar	2	350-375 (175-190)	8-10
Chocolate Chip cookies	2	350-375 (175-190)	8-13
Brownies	2	350(175)	29-36
Yeast bread loaf 9 x 5	2	375(190)	18-22
Yeast rolls	2	375-400 (190-205)	12-15
Biscuits	2	375-400 (190-205)	7-9
Muffi	2	425 (220)	15-19
Frozen Pizza	2	400-450 (205-235)	23-26
Fresh Pizza	2	425 (246)	15-18

Oven (continued)

2. Broil

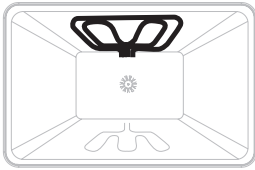

Broiling uses direct radiant heat to cook food. Thicker cuts and unevenly shaped of meat, fish, and poultry may cook better at lower broiling temperatures. *Tips: The oven door remains closed during broil. When inspecting the food, open the oven door no more than two inches.*

NOTES: Before broiling, position the rack to your needs

- For best results, use a two-piece broiler pan with a grid (not provided). It is designed to drain juices which helps to avoid spills and splatters.
- For proper draining, do not cover the grid with foil. The bottom of the pan may be lined with aluminum foil for easier cleaning.
- Trim excess fat to reduce spattering. Slit the remaining fat on the edges to avoid curling.
- Pull out the oven rack to stop position before turning or removing food. Use tongs to turn food to avoid the loss of juices. Very thin cuts of fish, poultry, or meat may not need to be turned.
- After broiling, remove the pan from the oven when removing the food. Drippings will bake on the pan if left in the heated oven, making cleaning more difficult.
- Position food on the grid in the broiler pan, then place it in the center of the oven rack. Close the oven door and set the control.

Food And Thickness	Rack Position	Broil Setting. °F (°C)	Level of Doneness	SIDE 1 Time (Min)	SIDE 2 Time (Min)
BEEF					
Steak (3/4"-1")	5	550 (290)	-Medium Rare -Medium -Well Done	- (5 - 7) - (6 - 8) - (8 - 10)	- (4 - 6) - (5 - 7) - (7 - 0)
Hamburgers (3/4"-1")	4	550 (290)	-Medium -Well Done	- (8 - 11) - (10-13)	- (6 - 9) - (8 - 10)
POULTRY					
Breast (bone-in)	4	450 (235)	Well Done	(10 - 12)	(8 - 10)
Thigh (very well done)	4	550 (290)	Well Done	(28 - 30)	(13 - 15)
PORK					
Pork Chops (1")	5	550 (290)	Well Done	(7- 9)	(5 - 7)
Sausage - fresh	5	550 (290)	Well Done	(5 - 7)	(3 - 5)
Ham Slice (1/2")	5	550 (290)	Well Done	(4 - 6)	(3 - 5)
SEAFOOD					
Fish Filets, 1" Buttered	4	450 (235)	Well Done	(10 - 14)	Do not turn
LAMB					
Chops (1")	5	550 (290)	-Medium Rare -Medium -Well Done	- (5 - 7) - (6 - 8) - (7 - 9)	- (4 - 6) - (4 - 6) - (5 - 7)
BREAD					
Garlic Bread, 1" slices	4 3	550 (290)		- (2 - 2:30) - (4 - 6)	

Oven (continued)

CONVECTION SETTINGS

During convection cooking, the fan provides hot air circulation throughout the oven. The movement of heated air around the food can help to speed up cooking by penetrating the cooler outer surfaces. The food cooks more evenly, browning and crisping outer surfaces while sealing moisture inside. When the oven is set to the Convection function, the bake and broil elements, and the fan operate to heat the oven cavity. *The convection fan operates during any convection function.

1. Convection Bake:

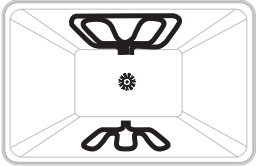
	<p>Compared to BAKE setting, Convection Bake adds the use of convection fan(s) to circulate heated air. So both the temperature and the cooking time may be slightly reduced. <i>Tips: When convection baking, reduce your recipe baking temperature by 25°F.</i></p>
---	---

- Use Convection Bake for single or multiple-rack baking. Reduce standard recipe baking temperature by 25°F (15°C).
 - For best results, foods should be cooked uncovered, in low-sided pans to take advantage of the forced air circulation. Use shiny aluminum pans for best results unless otherwise specified
 - Heatproof glass or ceramic can be used. Reduce the temperature by another 25°F (15°C) when using heatproof glass dishes for a total reduction of 50°F (30°C).
 - Dark metal pans may be used. Note that food may brown faster when using dark metal bakeware.
 - The number of racks used is determined by the height of the food to be cooked.
 - Baked items, for the most part, cook extremely well in convection. Don't try to convert recipes such as custards, quiches, pumpkin pie, or cheesecakes, which do not benefit from the convection-heating process. Use the regular Bake mode for these foods.
 - When baking four cake layers at the same time, stagger pans so that one pan is not directly above another. For best results, place cakes on front of upper rack and back of lower rack. Allow 1" - 1½" (2.5 - 4 cm) air space around pans.
1. Turn the cooking functions knob to the convection bake.
 2. Rotate the dial to the temperature you wish to use.
 3. You can open the door and place food in the oven.

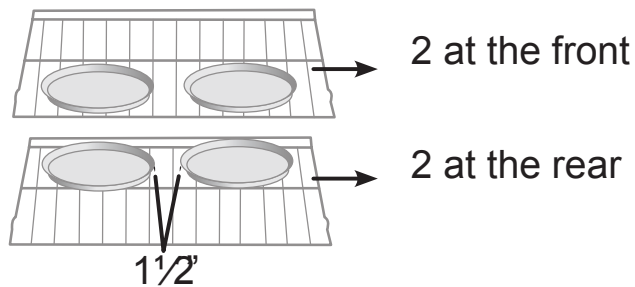

Oven (continued)

2. Convection Broil

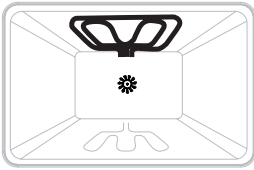
	<p>Convection Broil adds the use of convection fan(s) to circulate heated air. Bring the rack to the middle of the cavity to provide evening cooking.</p>
---	---

1. Turn the cooking functions knob to the convection BROIL.
2. Rotate the dial to the temperature you wish to use.
3. The oven will begin preheating. Do not open the door while the oven is preheating. When the oven had reached the set temperature, the indicator light on the control panel will turn off.
4. You can open the door and place food in the oven.

Guidelines:

- Place rack in the required position needed before turning on the oven.
- Use Convection Broil mode with the oven door closed. •When convection broiling, enter your normal broiling temperature.
- Do not preheat oven.
- Use the 2-piece broil pan.
- Turn meats once halfway through the cooking time. See the Convection Broil chart.
- Thicker cuts and unevenly shaped pieces of meat, fish and poultry may cook better at lower broiling temperatures

Food And Thickness	Rack Position	Broil Setting. °F (°C)	Level of Doneness	SIDE 1 Time (Min)	SIDE 2 Time (Min)
BEEF					
Steak (1½" or more)	4	450 (235)	-Medium Rare -Medium -Well Done	- (9 - 12) - (11 - 13) - (18 - 20)	- (8 - 10) - (10 - 12) - (16 - 17)
Hamburgers (more than 1")	4	550 (290)	-Medium -Well Done	- (8 - 11) - (11-13)	- (5 - 7) - (8 - 10)
POULTRY					
Chicken Quarters	4	450 (235)	Well Done	(16 - 18)	(10 - 13)
Chicken Halves	3	450 (235)	Well Done	(25 - 27)	(15 - 18)
Chicken Breasts	4	450 (235)	Well Done	(13 - 15)	(9 - 13)
PORK					
Pork Chops (1¼" or more)	4	450 (235)	Well Done	(12 - 14)	(11 - 13)
Sausage - fresh	4	450 (235)	Well Done	(4 - 6)	(3 - 5)

3. Convection Roast:

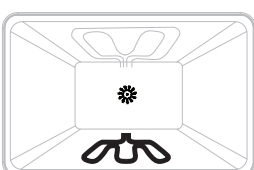
	<p>When convection roasting, turn to your normal roasting temperature. The roasting time should be 15-30% less than in conventional cooking. It is not necessary to preheat the oven for Convection Roast.</p>
---	--

1. Turn the cooking functions knob to the convection roast.
2. Rotate the dial to the temperature you wish to use.
3. You can open the door and place food in the oven.

Oven (continued)

Guidelines:

- Do not preheat for Convection Roast.
- Roast in a low-sided, uncovered pan.
- When roasting whole chickens or turkey, tuck wings behind back and loosely tie legs with kitchen string.
- Use the 2-piece broil pan for roasting uncovered.
- Double-check the internal temperature of meat or poultry by inserting meat thermometer into another position.
- Large poultry may need to be covered with foil (and pan roasted) during a portion of the roasting time to prevent over-browning.
- The minimum safe temperature for stuffing in poultry is 165°F (75°C)
- After removing the food from the oven, cover loosely with foil for 10 to 15 minutes before carving if necessary to increase the final foodstuff temperature by 5° to 10°F (3° to 6° C)

Food And Thickness	Weight (Lb)	Oven Temp. °F (°C)	Rack Position	Time (Min. Per Lb)	Internal Temp. °F (°C)
BEEF					
Rib Roast -	4 - 6	325 (160)	2	16-20 18-22	-145 (63) Medium Rare -160 (71) medium
Rib Eye Roast (boneless) -	4 - 6	325 (160)	2	16-20 18-22	-145 (63) Medium Rare -160 (71) medium
Rump, Eye, Tip, Sirloin (boneless) -	3 - 6	325 (160)	2	16-20 18-22	-145 (63) Medium Rare -160 (71) medium
Tenderloin Roast -	2 - 3	400 (205)	2	15-20	145 (63) Medium Rare
PORK					
Loin Roast (boneless or bone-in) -	5 - 8	350 (205)	2	16-20	160 (71) medium
Shoulder -	3 - 6	400 (205)	2	20-25	160 (71) medium
POULTRY					
Chicken whole-	3 - 4	375 (190)	2	18-21	180 (82)
Turkey, not stuffed	12 - 15	325 (160)	1	10-14	-180 (82)
	16 - 20	325 (160)	1	9-11	-180 (82)
	21 - 25	325 (160)	1	6 - 11	-180 (82)
Turkey Breast -	3 - 8	325 (160)	1	15-20	170 (77)
Comish Hen -	1 - 1 1/2	350 (205)	2	45-75 total	180 (82)
LAMB					
Half Leg -	3 - 4	325 (160)	2	22 - 27 28 - 33	-160 (71) medium -170 (77) well
Whole Leg -	6 - 8	325 (160)	1	22 - 27 28 - 33	-160 (71) medium -170 (77) well

Range Care

CLEANING

IMPORTANT: Before cleaning, make sure all controls are turned off, and the oven and cooktop are cool. Always follow label instructions on cleaning products. It is recommended that you first use soap, water and a soft cloth or sponge unless otherwise noted. Do not use abrasive cleaning products.

EXTERIOR PORCELAIN ENAMEL SURFACES

Food spills containing acids, such as vinegar and tomato, should be cleaned as soon as the entire appliance is cool.

These spills may affect the finish

Cleaning Method:

Glass cleaner, mild liquid cleaner or nonabrasive scrubbing pad: Gently clean around the model and serial number plate because scrubbing may remove numbers.

EXTERIOR STAINLESS STEEL

NOTE: Do not use soap-filled scouring pads, abrasive cleaners, cooktop polishing cream, steel-wool pads, gritty washcloths or some paper towels. Damage may occur, even with one-time or limited use. Rub in direction of grain to avoid damaging.

Cleaning Methods:

Liquid detergent or all-purpose cleaner: Rinse well with clean water and dry with soft, lint-free cloth.

Stainless Steel Cleaner and Polish

Vinegar for hard water spots

OVEN DOOR EXTERIOR

Cleaning Method:

Glass cleaner and paper towels or nonabrasive plastic scrubbing pad: Apply glass cleaner to soft cloth or sponge, not directly on panel.

CERAMIC GLASS COOKTOP

IMPORTANT: To avoid damaging the cooktop, do not use steel wool, abrasive powder cleansers, chlorine bleach, rust remover or ammonia. Ceramic cooktop cleaning materials: cooktop cleaner, cooktop scraper and cooktop cleaning pads are available at most grocery stores.

1. Remove food/residue with a cooktop scraper. For best results, use the cooktop scraper while the cooktop is still warm, but not hot to the touch. It is recommended to wear an oven mitt while scraping the warm cooktop.
 - Hold the cooktop scraper at approximately a 45° angle against the glass surface and scrape the residue. It will be necessary to apply pressure in order to remove the residue.
 - Allow the cooktop to cool down completely before proceeding to Step 2.
2. Apply a few dime-sized drops of cooktop cleaner to the affected areas
 - Rub cooktop cleaner onto the cooktop surface with a nylon or similar cooktop cleaning pad. Some pressure is needed to remove stubborn stains.
 - Allow the cleaner to dry to a white haze before proceeding to Step 3.
3. Polish with a clean, dry cloth or a clean, dry paper towel.

SMUDGES FROM ALUMINUM BOTTOMED PANS

Cleaning Method:

A cloth dampened in vinegar.

COOKTOP CONTROL KNOBS

- Pull knobs straight out from the control panel to remove.
- When replacing knobs, make sure knobs are turned to the Off position

Cleaning Method:

Soap and water or dishwasher:

NOTE: Do not use steel wool, abrasive cleansers or oven cleaner. Do not soak knobs.

Range Care (continued)

CONTROL PANEL

Cleaning Method:

Glass cleaner and soft cloth or sponge: Apply glass cleaner to soft cloth or sponge, not directly on panel.

NOTE: Do not use abrasive cleaners, steel-wool pads, gritty washcloths or some paper towels. Damage may occur.

OVEN CAVITY

Food spills should be cleaned when oven cools. At high temperatures, foods react with porcelain, so staining, etching, pitting or faint white spots can result.

Cleaning Method:

Mild detergent and warm water.

NOTE: Do not use oven cleaners.

OVEN RACKS

Cleaning Method:

Steel-wool pad

OVEN DOOR REMOVAL

For normal oven use, there is no need to remove the oven door. However, should it become necessary to remove the door, follow the instructions in this section.

IMPORTANT:

- › When you are planning to clean the oven doors, it is recommended to do this step several hours after the unit has been used. Make sure the unit is off and fully cool down
- › Keep in mind the oven door is heavy, fragile, and the front door has glass. To avoid the glass from breaking, use both hands and grasp only the sides of the oven door to remove it.
- › Be sure that both levers are securely in place before removing the door.
- › Do not force doors open or closed.

To remove the oven door:

1. Open the oven door completely.
2. Lift up the hinge latch on each side.

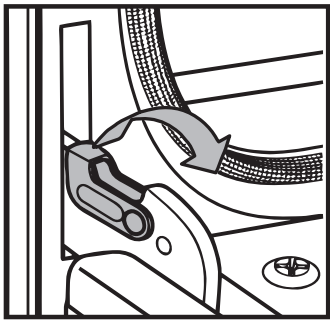

Left hinge

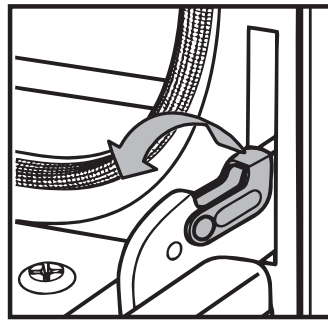

Right hinge

3. Close the oven door as far as it will shut.
4. While grasping both outside edges of the oven door, lift up on the door.
5. Continue to push the top of the door closed while pulling the bottom of the door out of the hinge receivers in the door frame.

Range Care (continued)

To place back the oven door:

1. Insert both hanger arms into the hinge receivers in the door frame.
2. Slowly open the oven door, and you will feel the door set into place.
3. Move the hinge latches back into the locked position.

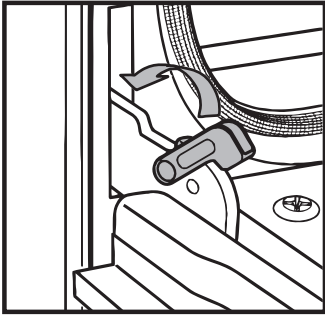

Left hinge

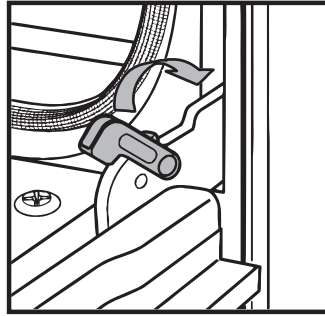

Right hinge

4. Check that the door opens and closes freely. If it does not, repeat the door removal and placing the oven door back.



WARNING



Electrical Shock Hazard

- Make sure the oven and lights are cool and power to the oven has been turned off before replacing the light bulb(s)
- The lenses must be in place when using the oven. The lenses serve to protect the light bulb from breaking.
- The lenses are made of glass. Handle carefully to avoid breakage.
- Failure to do so could result in death, electric shock, cuts or burns.

REPLACING AN OVEN LIGHT

The oven light is a standard 25-watt (G9) appliance bulb.

IMPORTANT: Before replacing the bulb, make sure the oven is cool and the controls are turned off

1. Disconnect the power.
2. Remove the bulb cover by turning it anti-clockwise.

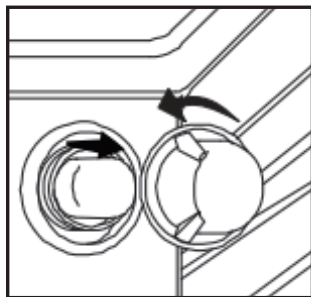

3. Remove the burned-out bulb from the socket.

NOTE: To avoid damage or decreasing the life of the new bulb, do not touch the bulb with bare fingers. Use ear gloves or use a tissue when replacing the light bulb.

4. Replace the bulb, and then replace the bulb cover.
5. Reconnect the power.

Troubleshooting

• BAKING AND ROASTING PROBLEMS

Before contacting Forno customer service, please check the chart below for cases that may apply to you. It can be simple misuse of material, shapes, and sizes of bakeware that causes poor results.

Baking Issues	Causes
Food browns unevenly	<ul style="list-style-type: none"> • Oven not preheated • Aluminum foil on oven rack or oven bottom • Baking utensil too large for recipe • Pans touching each other or oven walls
Food too brown on bottom	<ul style="list-style-type: none"> • Oven not preheated • Using glass, dull or darkened metal pans • Incorrect rack position • Pans touching each other or oven walls
Food is dry or has shrunk excessively	<ul style="list-style-type: none"> • Oven not preheated • Using glass, dull or darkened metal pans • Incorrect rack position • Pans touching each other or oven walls
Food is baking or roasting too slowly	<ul style="list-style-type: none"> • Oven temperature too high • Baking time too long • Oven door opened frequently • Pan size too large
Piecrusts do not brown on bottom or crust is soggy	<ul style="list-style-type: none"> • Baking time not long enough • Using shiny steel pans • Incorrect rack position • Oven temperature is too low
Cakes pale, flat and may not be done inside	<ul style="list-style-type: none"> • Oven temperature too low • Incorrect baking time • Cake tested too soon • Oven door opened too often • Pan size may be too large
Cakes high in middle with crack on top	<ul style="list-style-type: none"> • Oven temperature too high • Baking time too long • Pans touching each other or oven walls • Incorrect rack position • Pan size too small
Piecrust edges too brown	<ul style="list-style-type: none"> • Oven temperature too high • Edges of crust too thin

Troubleshooting (continued)

- COOKTOP

Baking Issues	Possible Causes	Solutions
Heating elements and controls do not work.	Fuse is blown or circuit breaker is tripped. No electricity to the cooktop.	Replace the fuse or reset the circuit breaker. If the problem continues, call an electrician. Have electrician check your power supply.
Heating elements do not heat properly.	Improper cookware is being used.	Select proper cookware. See "Cookware." If the problem continues, call for service.
Heating elements cycle off even when elements are turned to their highest settings.	Heating element temperature limiters are temporarily shutting off the elements due to exceeding the maximum allowable temperature	This is a normal operating condition, especially during rapid heat-up operations. The element will cycle back on automatically after it has cooled sufficient .
Glass ceramic surface is see through or appears to be red in color.	Under direct or bright lighting, you will sometimes be able to see through the glass and into the chassis due to its transparent quality. You may also notice a red tint under these conditions	These are normal properties of black ceramic glass panels.

Troubleshooting (continued)

- OVEN

Baking Issues	Possible Causes	Solutions
Oven is not heating	No power to the oven	Replace the fuse or reset the circuit breaker. If the problem continues, call an electrician.
	Oven control not turned on	Make sure the oven temperature
	Oven door is not closed	Close the oven door. The heating elements turn off when the door is opened and remain off until the oven door is closed
Oven is not cooking evenly	Not using the correct bake ware or oven rack position	Refer to cook charts for recommended rack position. Always reduce recipe temperature by 25 °F (15 °C) when baking with Convection Bake mode.
Oven display stays Off	Power interruption	Turn off power at the main power supply (fuse or breaker box). Turn breaker back on. If condition persists, call for service.
Oven mode and temperature controls cannot be set.	The oven door is open.	Close the oven door. The oven mode and temperature controls cannot be set if the oven door is open.
Cooling fan continues to run after oven is turned off	The electronic components have not yet cooled sufficient	The fan will turn off automatically when the electronic components have cooled sufficient
Oven light is not working properly	Light bulb loose or burned-out.	Reinsert or replace the light bulb. Touching the bulb with fingers may cause the bulb to burn out
Oven light stays on	Door is not closing completely	Check for obstruction in oven door. Check to see if hinge is bent or door switch broken.
Cannot remove lens cover	Soil build-up around the lens cover.	Wipe lens cover area with a clean, dry towel prior to attempting to remove the lens cover.
Clock and timer are not working properly	No power to the oven	Check the circuit breaker or fuse box to your house. Make sure there is proper electrical power to the oven.
Excessive Moisture		When using bake mode, preheat the oven first. Convection Bake and Convection Roast will eliminate any moisture in the oven.
Porcelain Chips	Porcelain interior is bumped by oven racks	When removing and replacing oven racks, always tilt racks upward and do not force them to avoid chipping the porcelain.

Warranty

What this limited warranty covers:

The Warranty coverage provided by Forno Appliances in this statement applies exclusively to the original Forno appliance ("Product") sold to the consumer ("Purchaser") by an authorized Forno dealer/distributor/retailer, purchased and installed in the United States or Canada, and which has always remained within the original country of purchase (the United States or Canada). Warranty coverage is activated on the date of the Product's original retail purchase and has a duration of two (2) years.

Warranty coverage is non-transferable. In the event of replacement of parts or of the entire product, the replacement Product (or parts) shall assume the remaining original Warranty activated with the original retail purchase document. This Warranty shall not be extended with respect to such replacement. Forno Appliances will repair or replace any component/part which fails or proves defective due to materials and/or workmanship within 2 years of the date of the original retail purchase and under conditions of ordinary residential, non-commercial use. Repair or replacement will be free of charge, including labor at standard rates and shipping expenses. Purchaser is responsible for making the Product reasonably accessible for service. Repair service must be performed by a Forno Authorized Service company during normal working hours.

Important

Retain proof of original purchase to establish warranty period. Forno's liability on any claim of any kind, with respect to the goods and/or services provided, shall in no event exceed the value of the goods or service or part there of which has given rise to the claim.

30-Day Cosmetic Warranty

The Purchaser must inspect the product at the time of delivery. Forno warrants that the Product is free from manufacturing defects in materials and workmanship for a period of thirty (30) days from date of the original retail purchase of the Product.

This coverage includes:

- Paint blemishes
- Chips
- Macroscopic finish defect

Cosmetic warranty does NOT cover:

- Issues resulting from incorrect transport, handling and/or installation (e.g.: dents, broken, warped or deformed structures or components, cracked or otherwise damaged glass components);
- Slight color variations on painted/enamelled components;
- Differences caused by natural or artificial lighting, locati or other analogous factors; > stains/corrosion/discoloration caused by external substances and/or environmental factors; > labor costs, display, floo , B-stock, out- of-box, "as is" appliances and demo units.

How to receive service

To receive warranty services, the Purchaser must contact the Forno Support department in order to determine the problem and the required service procedures. Troubleshooting with a customer service representative will be necessary before moving forward with the service. Model number, serial number and date of original retail purchase will be requested.

Warranty Exclusions: What Is Not Covered.

- Use of the Product in any non-residential, commercial

application.

- Use of the Product for anything other than its intended purpose.
- Repair services provided by anyone other than a Forno Authorized Service agency.
- Damages or repair services to correct services provided by unauthorized parties or the use of unauthorized parts.
- Installation not in accordance with local/state/city/county fir codes, electrical codes, gas codes, plumbing codes, building codes, laws or regulations.
- Defects or damage due to improper storage of the Product.
- Defects, damage or missing parts on products sold out of the original factory packaging or from displays. > Service calls or repairs to correct an incorrect installation of the Product and/or related accessories.
- Replacement of parts/service calls to connect, convert or otherwise repair the electrical wiring and/or gas line in order to properly use the product.
- Replacement of parts/service calls to provide instructions and information on the use of the Product.
- Replacement of parts/service calls to correct issues arising from the product being used in a manner other than what is normal and customary for residential use.
- Replacement of parts/service calls due to wear and tear of components such as seals, knobs, pan supports, shelving, cutlery baskets, buttons, touch displays, scratched or broken ceramic-glass tops.
- Replacement of parts/service calls for lack of/improper maintenance, including but not limited to: build up of residues, stains, scratches, discoloration, corrosion.
- Defects and damages arising from accidents, alteration, misuse, abuse or improper installation.
- Defects and damages arising from Product transport, logistics and handling. Inspection of the product must be made at time of delivery. Following receipt and inspection, the selling dealer/delivery company must be notified of an issues arising from handling, transport and logistics.
- Defects and damages arising from external forces beyond the control of Forno Appliances, including but not limited to wind, rain, sand, fires, floods, mudslides, freezi temperatures, excessive moisture or extended exposure to humidity, power surges, lightning, structural failures surrounding the appliance and other acts of God.
- Products whose serial number has been altered/damaged/ tampered with. In no case shall Forno be held liable or responsible for damage to surrounding property, including furniture, cabinetry, flooring, panels, and othe structures surrounding the Product. Forno is neither liable nor responsible for the Product if it is located in a remote area or an area where certified trained technician are not reasonably available. Purchaser must bear any transportation and delivery costs of the Product to the nearest Authorized Service Center or the additional travel expenses of a certified trained technicia

Warranty (Continued)

THERE ARE NO EXPRESS WARRANTIES OTHER THAN THOSE LISTED AND DESCRIBED ABOVE, AND NO WARRANTIES, EITHER EXPRESS OR IMPLIED, INCLUDING, BUT NOT LIMITED TO, ANY IMPLIED WARRANTIES OF MERCHANTABILITY OR FITNESS FOR A PARTICULAR PURPOSE THAT SHALL APPLY AFTER THE EXPRESS WARRANTY PERIODS STATED ABOVE, AND NO OTHER EXPRESS WARRANTY OR GUARANTEE GIVEN BY ANY PERSON, FIRM OR CORPORATION WITH RESPECT TO THIS PRODUCT SHALL BE BINDING ON FORNO. FORNO SHALL NOT BE LIABLE FOR LOSS OF REVENUE OR PROFITS, FAILURE TO REALIZE SAVINGS OR OTHER BENEFITS, TIME AWAY FROM WORK, MEALS, LOSS OF FOOD OR BEVERAGES, TRAVELING OR HOTEL EXPENSES, EXPENSES TO RENT OR PURCHASE APPLIANCES, REMODELING/CONSTRUCTION EXPENSES IN EXCESS OF DIRECT DAMAGES WHICH ARE UNDENIABLY CAUSED EXCLUSIVELY BY FORNO OR ANY OTHER SPECIAL, INCIDENTAL OR CONSEQUENTIAL DAMAGES CAUSED BY THE USE, MISUSE OR INABILITY TO USE THIS PRODUCT, REGARDLESS OF THE LEGAL THEORY ON WHICH THE CLAIM IS BASED, AND EVEN IF FORNO HAS BEEN ADVISED OF THE POSSIBILITY OF SUCH DAMAGES. NOR SHALL RECOVERY OF ANY KIND AGAINST FORNO BE GREATER IN AMOUNT THAN THE PURCHASE PRICE OF THE PRODUCT SOLD BY FORNO AND CAUSING THE ALLEGED DAMAGE. WITHOUT PREJUDICE TO THE FOREGOING, PURCHASER ASSUMES ALL RISK AND LIABILITY FOR LOSS, DAMAGE OR INJURY TO PURCHASER AND PURCHASER'S PROPERTY AND TO OTHERS AND THEIR PROPERTY ARISING FROM THE USE, MISUSE, OR INABILITY TO USE THIS PRODUCT SOLD BY FORNO THAT IS NOT A DIRECT RESULT OF NEGLIGENCE ON THE PART OF FORNO THIS LIMITED WARRANTY SHALL NOT EXTEND TO ANYONE OTHER THAN THE ORIGINAL PURCHASER OF THIS PRODUCT, IS NON-TRANSFERABLE, AND STATES YOUR EXCLUSIVE REMEDY.



Customer Support: Call 1-866-231-8893 or email: info@forno.ca