

Recliner Assembly Instructions

Estimated Assembly

Time in Minutes

★ ☆ ☆
 <15 <45 60+



Your recliner comes packaged in one box.

DO NOT use any sharp objects to open plastic wrapped components as damage to product or components may result.

Carefully remove all of the components from the packaging and set aside for assembly. Assemble on a soft surface to prevent scratching the finish.

Parts List

A 1 x Seat Back



B 1 x Seat

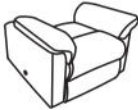

* **C** 1 x Handle



* **D** 1 x Bolt

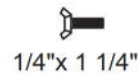

* **E** 1 x Wing Nut



Hardware List

* **F** 1 x Lock Washers



* Replaceable Parts

Hardware bag can be found under the seat

Assembly

Step 1

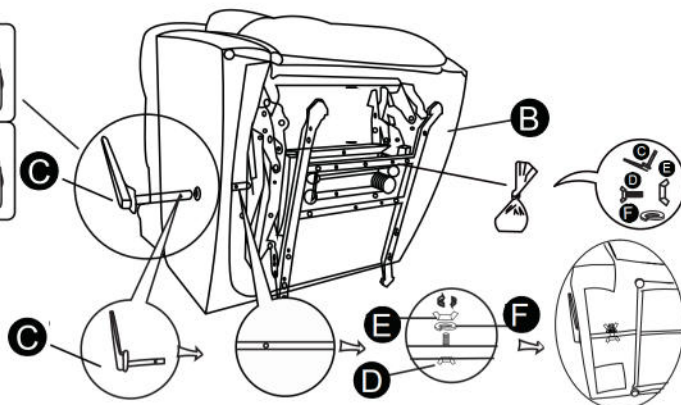
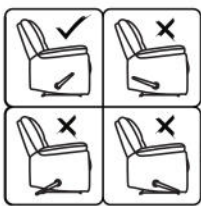

Step 2

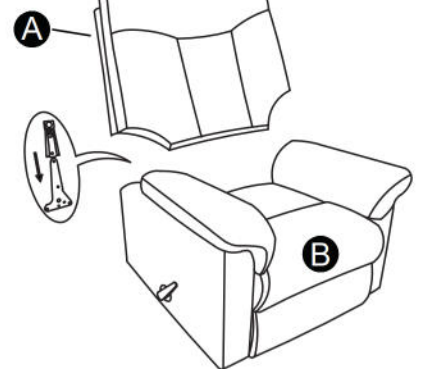

Step 3

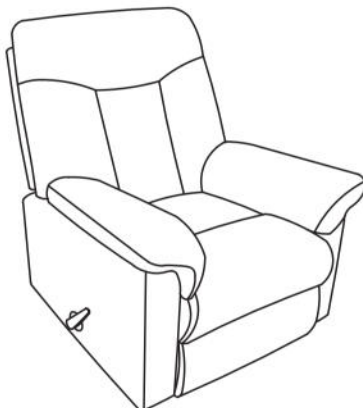

Please note the handle is used to release the foot rest. Use your arms to recline all the way back. To close, please use your legs to push the foot rest down.

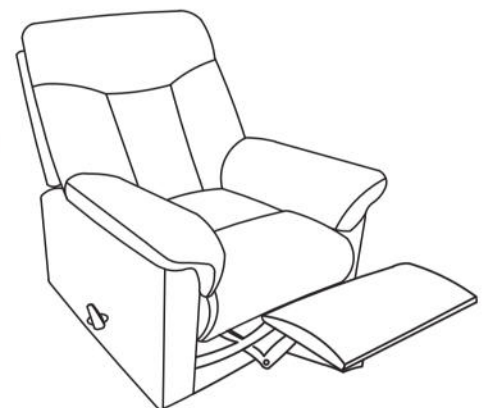

Your recliner style may differ from images. Care for your furniture by periodically tightening all bolts.

About your furniture piece:

- Softening of foam is natural and will happen over time with use.
- Fabric will fade or discolor in direct sunlight. Minimize exposure to direct sunlight to extend the life of your furniture.
- Wood grain, knots, streaks, and color variation occur naturally in wood and are not considered defects.

CAUTION: Tighten all components securely before use. Failure to do so may result in personal injury.

Customer Support: 866-238-0531
 Mon-Fri 8:00am - 4:30pm CST
customerservice@furniturequestions.com