



The Most Ingenious Pet Products On The Planet

Power Pet[®]

Fully Automatic Pet Door



INSTALLATION
& OPERATING INSTRUCTIONS



IMPORTANT NOTE :

Before going any further, please make sure that all products are accounted for, and to also test the door for proper function before installing into place. If the product fails to perform as advertised, or if you are missing any items from your order, please reach out to us via telephone or email right away. You can reach us at :

1-800-255-1279 - Monday - Friday 6:30 am - 4:00 pm PST
info@hightechpet.com

YOUR POWER PET PX DOOR PACKAGE INCLUDES : (as shown on the next page)

- **One Pet Transmitter Collar** (Model **MS-5 collar** or optional **RX-10 rechargeable collar**)
- **110 Volt AC Adapter** (Connects to either power input jack on edge of inside frame, on the left or right side)
- **Pre-Fabricated inside and outside frame**
- **Mounting Hardware**

(Aluminum Wall Tunnel, Rechargeable Battery, and Extra Transmitter Collars are sold separately.)

PACKAGE CONTENTS :



POWER PET DOOR
(INSIDE AND OUTSIDE FRAME)



MS-5 COLLAR
(NO PAIRING OR SYNCING REQUIRED)



AC ADAPTER

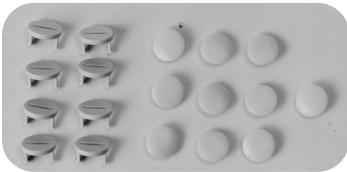

SCREW CAP COVERS
(FOR INSIDE AND OUTSIDE FRAME)

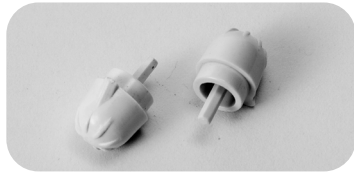

**RANGE ADJUSTMENT
KNOBS**

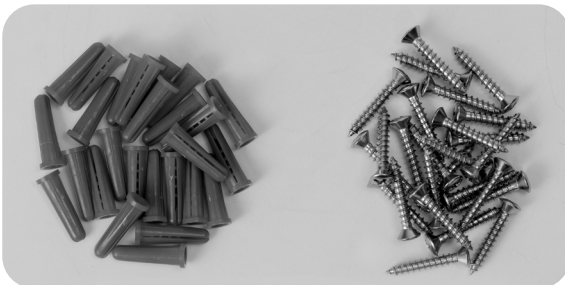

MOUNTING HARDWARE

INTRODUCTION

PRODUCT DESCRIPTION:

Your new Power Pet™ (PX) Electronic Pet Door is like no other pet door made. Patented Power Pet electronic pet doors are fully automatic, motor driven and open completely under their own power. Activated by an ultrasonic pet collar, your new Power Pet door will keep out stray animals. It is secure against wind, cold, and snow, and provides much better insulation than a conventional flap door. Your new Power Pet door features an attractive, high-strength door panel that quickly and quietly powers upward disappearing into the stylish housing. Your pets are empowered to come and go as they please while their animal friends are politely asked to stay out.

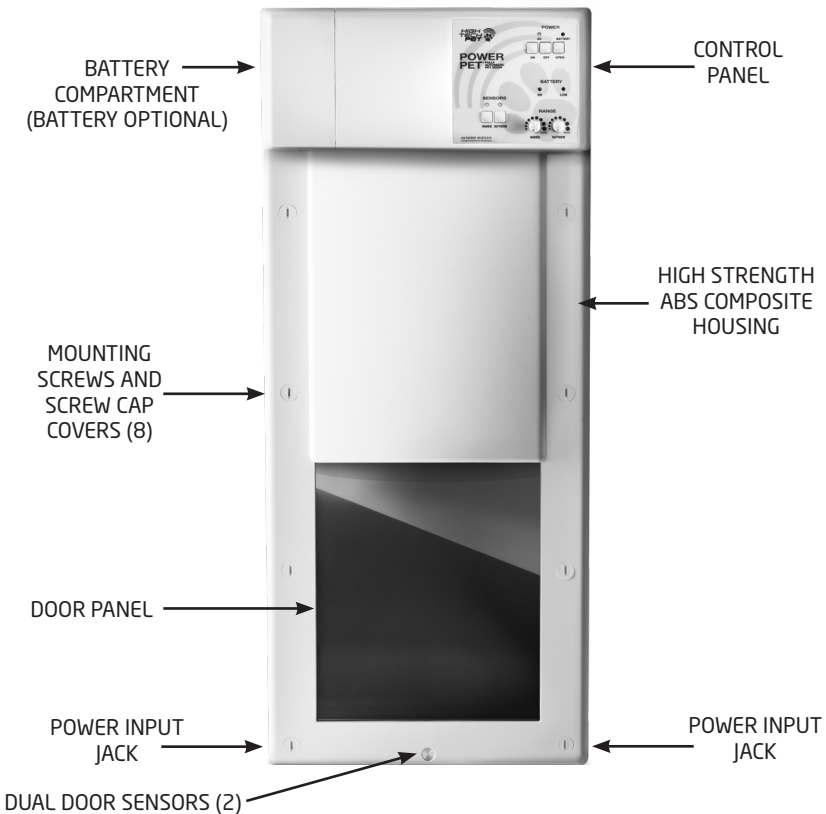

Power Pet doors increase home security with a special automatic, deadbolt locking feature that guards against would-be intruders. Only the coded signal from your pet's collar will open the Power Pet door.

Only Power Pet doors feature an ingenious directional sensing system that operates a fully automatic, motor driven panel. The signal emitted from your pet's collar tells the Power Pet door how far away your pet is and the direction in which your pet is traveling. This allows the Power Pet door to work like magic, opening only when your pet is on a direct approach, not when it is just wandering by and not when it is sitting or sleeping next to the door.

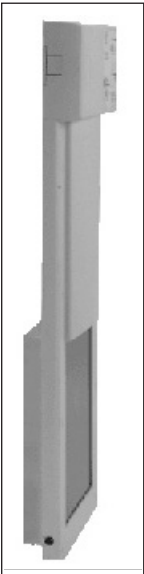

ALL NEW DESIGN!

After selling thousands of our original Power Pet (PP) models we are very pleased to introduce our All New, completely redesigned and restyled Power Pet PX Model. We listened to the feedback of hundreds of customers and threw in a few ingenious, new ideas of our own to bring you the ultimate combination of security, style and convenient features.

The PX model, which features an extremely slim design, is less than 2 inches deep. This allows it to be mounted flush to your door or wall. You cut a hole only as large as the door panel opening itself, then mount your Power Pet door in front of the opening. You will find it is actually easier to install a Power Pet door than a conventional pet door and certainly easier than installing a "between the studs type door."

The PX is constructed of an ultra-high strength ABS composite housing with a extremely durable Lexan plastic door panel, giving you and your pet the ultimate in security. The Lexan panel is mounted on a sliding, air-tight seal for the best wind and foul weather protection of any pet door made.

This new, absolutely state of the art design represents unquestionably the most advanced, most reliable, most stylish pet door made anywhere. In fact, your new Power Pet Fully Automatic Pet Door will be the most sophisticated appliance your pet will ever own!

DIRECTIONAL ULTRASONIC SENSING SYSTEM

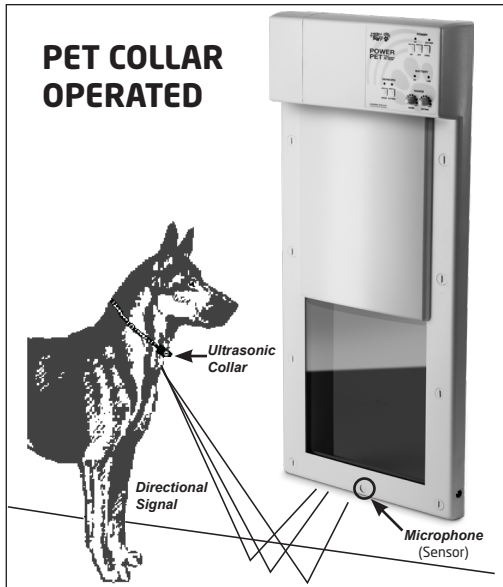

Only the amazing Power Pet door uses our Patented directional ultrasonic sensing system. This system has great advantages over magnetic or radio transmitter collars.

Magnetic collars have a very limited range making it tough to train the pet to operate the door. Radio systems have good range but open whenever the animal is within that range, even if the pet is sitting, sleeping or just wandering by.

The Power Pet's directional ultrasonic system overcomes these problems. The pet worn ultrasonic collar emits a highly directional signal, which is received by the microphones / dual sensors only when your pet is directly facing the door opening. The unit is not likely to trigger if your pet is just wandering by.

Typically the ultrasonic signal is bounced off the ground in the direction which your pet is facing. This means that surfaces which are highly reflective such as tile and linoleum will result in a longer working range than acoustically absorbent surfaces such as carpeting. Consult the **ADJUSTING RANGE CONTROLS** section for instructions on setting the desired opening range.

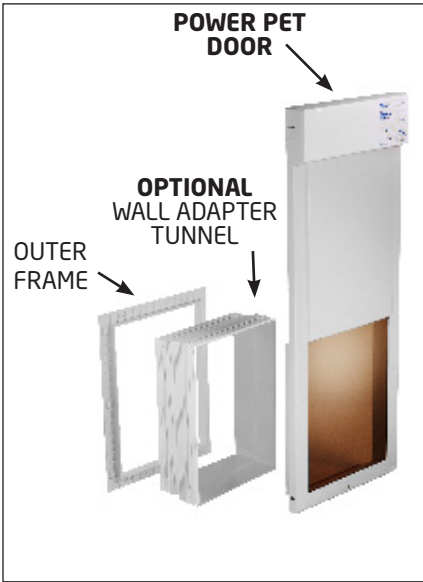

INSTALLATION OVERVIEW

MOUNTING YOUR POWER PET DOOR

Your POWER PET door mounts flush to any door or wall. The hardest part of installing the POWER PET door is cutting the hole. If the unit is to be mounted in a door up to 1 3/4" thick there is no framing necessary. The pre-made outer frame that came with your Power Pet door will provide a finished look to the opening. If you are installing your Power Pet door in a wall, it is advisable to build a frame around the opening or order our convenient Wall Adapter Tunnel. The hole dimensions given are for the finished opening not including the frame. Dimensions of the frame you build should be added to the opening size to determine the final size of the hole you cut in your wall.

WALL INSTALLATION

DOOR INSTALLATION

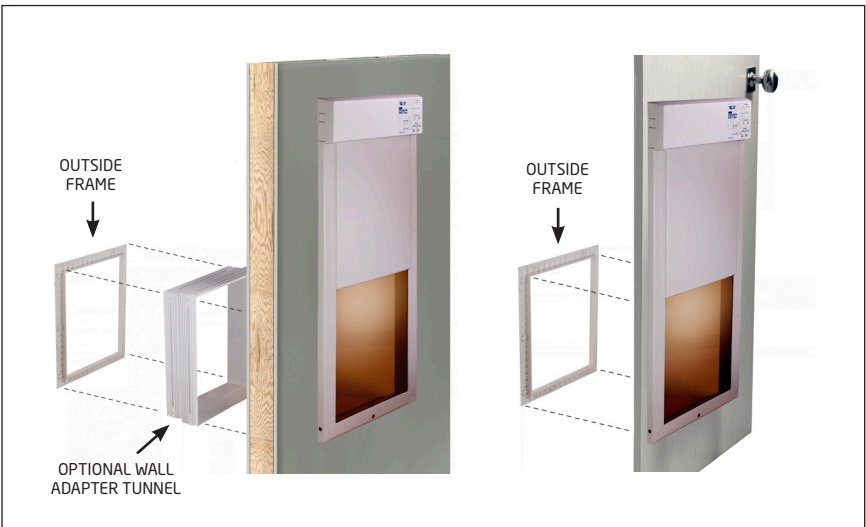

POSITIONING THE OPENING ON THE DOOR OR WALL

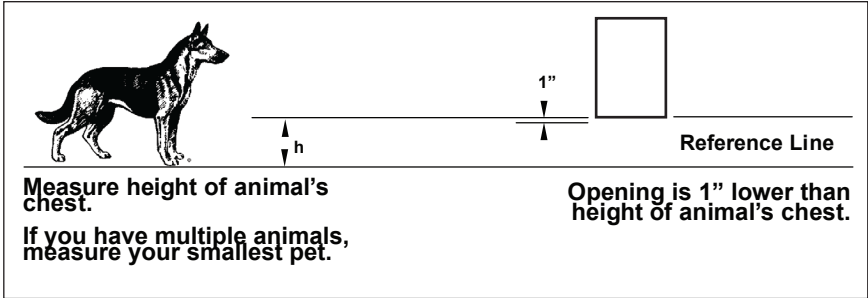

CUT OUT DIMENSIONS : (in inches)

MODEL - POWER PET DOOR - PX-1

Size : Medium
Width : 9 "
Height : 11.5 "

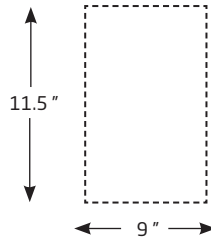

MODEL - POWER PET DOOR - PX-2

Size : Large
Width : 13 "
Height : 17.5 "

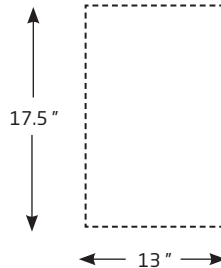

INSTALLING YOUR POWER PET DOOR

This is the easy part. Install the Power Pet door and the outside frame as shown below.

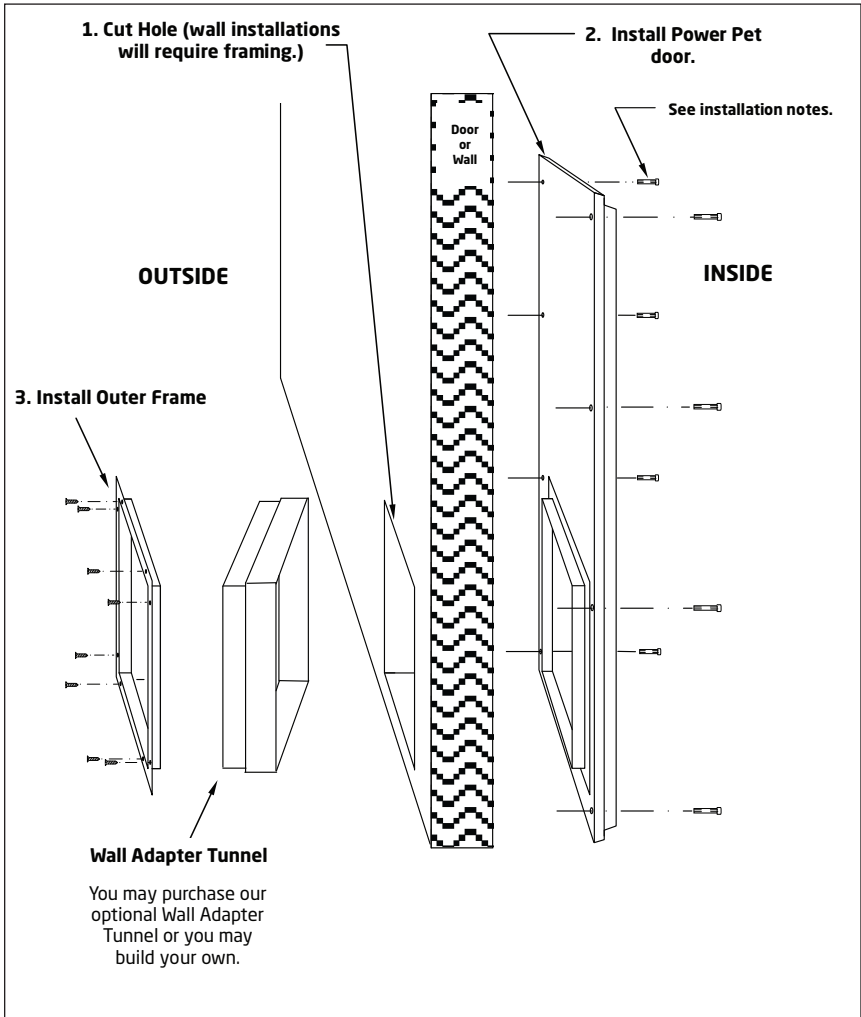

IMPORTANT INSTALLATION NOTES :

When installing the (8) inside mounting screws, make sure they are only moderately hand tightened. Over tightening will cause your Power Pet door housing to conform to any irregularities in the flatness of your door or wall and will cause the door panel to slow, stick or malfunction. Just tighten the screws until they stop. That is enough to insure that the installation is secure.

Note that the inside screw cap covers (not pictured) are provided to cover and finish the screw holes. Once installed, the inside screw covers may be removed by **gently** turning CLOCKWISE using a small coin or flat head screwdriver. Twisting counter-clockwise will cause the screw covers to break.

INITIAL POWER

Plug the AC Adapter into a nearby 110 VAC wall outlet. Plug the adapter cord into the left or right Power Input Jack on the inside frame. **(See Introduction Page.)**

Press the front control panel ON button to power up the door. Verify the AC light is illuminated.

Press the manual OPEN button on your control panel and verify the door panel opens and closes by itself. If it does not, please double check your 8 mounting screws as mentioned above.

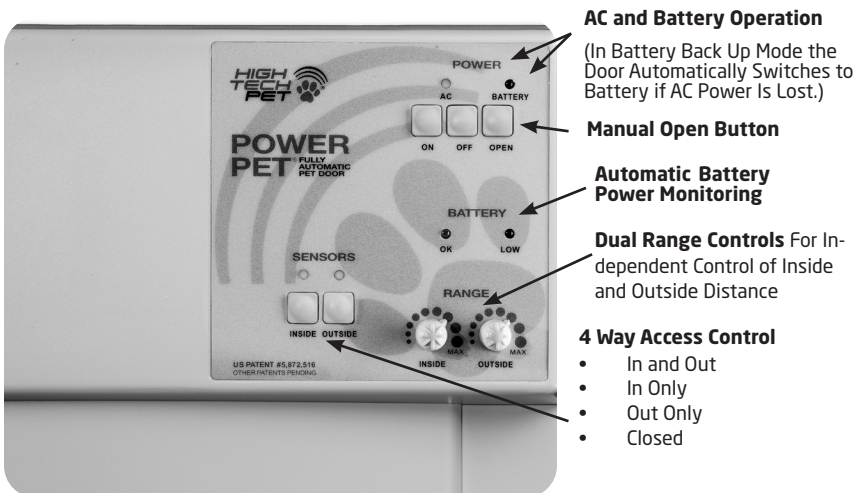

BATTERY INSTALLATION

To install the rechargeable battery, open the battery compartment, and gently align the two battery lugs with the two lug sockets on the inner wall of the battery compartment. Then press the battery to mate it to the sockets. When done the battery should be flush with the wall, and the compartment cover should fit comfortably over the installed battery.

An installed battery is automatically charged whenever the AC Adapter is powering the door.

BATTERY STATUS INDICATORS

The OK light is illuminated when the battery is more than one-third charged.

The LOW light illuminates when the battery is less than one-third charged.

Note that during door opening these indicators may reverse for a few seconds when the battery is below one-half charge. This is normal and gives a little advance notice of an impending low battery.

BATTERY OPERATION

Whenever AC Power is unavailable and a fully charged battery is installed, **the front panel LED light indicators go into a low power mode where they blink every four seconds instead of remaining on continuously.** This feature allows the battery to power the door for up to 500 openings.

ADVANCED FEATURES

INTRINSICALLY SAFE OPERATION

The Power Pet electronic pet door is intrinsically safe. It uses an electric motor and cable drive to lift the door panel. The panel remains open until the pet collar signal is gone, indicating that your pet is clear of the opening. When the pet collar signal is gone, power to the motor is turned off and the panel is returned by the force of gravity only. Downward speed is reduced by an electronic brake applied to the reverse motion of the motor. This brake operates with or without electrical power. Because the panel is returned by simple gravity, the maximum force that can be applied by the panel when it is closing is limited to its own weight. The door panel weighs only about 2 pounds.

AUTO RETRACT FEATURE

As an added safety feature, the Power Pet door also has a sensing system that automatically raises the panel should it encounter an obstruction on the -

way down. This feature can be defeated in the unusual case that binding or other restriction slows the door closure to the point that it unnecessarily retracts (up and down). See the **AUTOMATIC SAFETY RETRACT** Section for more information.

AUTO DEAD BOLT LOCKING FEATURE

The Power Pet door uses a spring loaded locking pin which automatically snaps into its retaining hole when the movable panel comes to rest in the closed or off position. The pin can only be released when the motor applies tension to the cable. This makes it impossible for even the most clever animals (and people) to raise the panel mechanically.

THREE DIFFERENT POWER CHOICES : Your new Power Pet door may be operated in three different power modes :

- 1. 110 volt AC Wall Outlet:** Your standard Power Pet door comes standard with a U.L. approved AC adapter. Plug the adapter into a nearby wall outlet for continuous operation.
- 2. AC with Battery Back-up:** You may purchase an optional rechargeable battery for use along with your AC adapter. If your household electricity should ever fail, your Power Pet door will automatically switch over to battery operation. When power is restored, the AC adapter will automatically recharge your battery.
- 3. Full Battery Operation:** You may also operate your standard Power Pet door with the battery only. Only available with our standard Power Pet door. This eliminates the need for the AC adapter or any electrical power connection. However, you will need to recharge the battery periodically. (Recharge interval varies depending upon use.) In this case, we recommend that you purchase the optional battery and a battery charger kit. With the charger kit you get a battery charger and either 1 or 2 batteries. Use one battery in your Power Pet door and keep the other in the charger. When your door battery runs low, just swap.

DUAL RANGE CONTROLS: Individual range control to allow you to adjust different activation distances for inside and outside of your home. (Usually, it's a good idea to use a short distance of a foot or two inside, and a longer 4 to 5 foot distance outside.) Your new Power Pet PX gives you full control. Note: range markings on the door are not in units of distance, but rather in signal strength. A marking of the largest dot produces the maximum distance (all the way to the right and vice versa.)

ADJUSTING THE RANGE

When you first install the Power Pet (PX) door, pre-set both RANGE Controls - one at a time - to the desired activation distance as follows :

- Enable/turn on just the INSIDE or OUTSIDE sensor and set that RANGE adjustment knob control to zero (all the way to the left.)
- Hold the collar at about your pet's height, pointing down toward the bottom of the door and at the desired activation distance from the door.
- Slowly increase that RANGE knob control setting until the door panel opens.
- Repeat this process for the other sensor as well.
- Now put the collar on the pet and, if necessary, readjust the RANGE knob settings slightly to achieve the desired opening distance.

Just as your hearing of a conversation can be overpowered by loud noises such as a lawn mower, the door sensors can also be overpowered by loud ultrasonic noises. Specifically some sprinklers, lawn mowers and vacuum cleaners can put out enough noise to temporarily mask the collar signal. The Power Pet (PX) door has a unique feature which indicates when the background noise level is too high.

NOTE : Whenever the INSIDE noise is too loud, the INSIDE sensor LED light will flicker or flash on. This means you may want to decrease the INSIDE range knob setting slightly. Likewise, whenever the OUTSIDE noise is too high, the OUTSIDE sensor LED light will flicker or flash on. This means you may want to decrease slightly the OUTSIDE range knob setting. A little flickering once in a while is normal. A lot of flickering or continuous flashing means the knob is set too high.

4 WAY ACCESS CONTROL : Individual activation buttons for the inside and outside sensors give you a 4-way access control system. You can allow your pet to come in but not go out, go out but not come in, come in and out or close and lock the door altogether.

AUTOMATIC CLOSE CONTROL : Your Power Pet door features a smart sensing circuit that keeps the door panel open as long as it is receiving the signal from your pet's collar. Once your pet has moved completely through the opening, the panel closes.

ADJUSTABLE HOLD UP TIME : The door is held open for a short time to let the pet get fully through the door before it starts closing. Depending on the speed your pet moves, you may adjust the hold up time as follows.

INSIDE	OUTSIDE	TIME
•		2 SEC.
	•	4 SEC.
•	•	6 SEC.

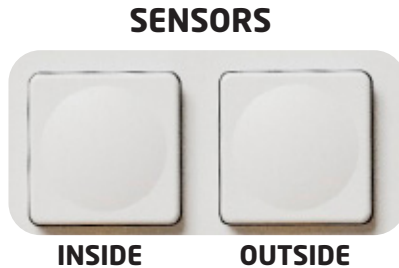

1. Press the **OFF** button.
2. Press and hold either **one or both sensor buttons** to select the hold up time as shown above.
3. While holding one or both sensor buttons, press the **OFF** button with your other hand to save this hold up time, then release all buttons.
4. Press the **ON** button to power the door up and then test it.

When shipped from the factory, the hold up time is set to 4 seconds. We recommend you initially introduce your pet to the door with a long hold up time. Later you can adjust the hold up time if desired.

HOLD OPEN FEATURE : A feature that was introduced in 2012 allows the door to be manually opened and stay open for any length of time.

If you wish to leave the door open for an extended time period, use the **hold open mode**, as follows. The door panel will remain open as long as

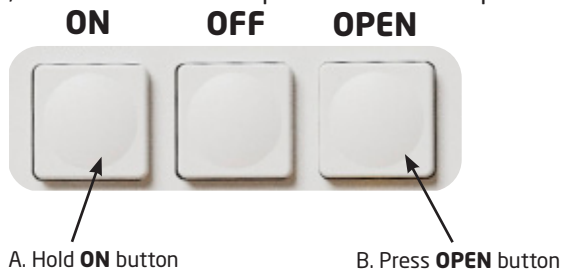

To return to normal operation - press just the **open** button.

PLEASE NOTE :

When using the hold open feature, the opening motor is energized the entire time the door is open. So if using only a battery to power the door, and you do not have an AC power adapter plugged into the door, use this feature sparingly to keep from discharging the battery in just a few hours.

AUTOMATIC SAFETY RETRACT:

Your Power Pet door is intrinsically safe for all pets and people, including small children. The door panel weighs less than 2 pounds and is closed smoothly by gravity (not the motor) and is too light to cause any physical injury. However, just to be doubly safe around infants, we've included an automatic safety retract feature. This feature causes the panel to instantly retract if it encounters an obstruction during closure.

DEFEATING THE AUTOMATIC SAFETY RETRACT:

Under unusual conditions, such as a warped wall mounting, the door sometimes may close so slowly that the auto-retract feature triggers the door to re-open unnecessarily. In these cases it may be desirable to defeat the Automatic Safety Retract feature. Do this by first pressing the **OFF** button to turn off the door controls and all the lights. Leave the door powered by the ac adapter or battery when you do this. Then while holding down the **MANUAL OPEN** button, press and release the **OUTSIDE SENSOR** button. The **OUTSIDE** sensor light will blink to indicate the feature has been disabled.

ENABLING AUTOMATIC SAFETY RETRACT:

Similarly you may enable the Automatic Safety Retract feature at any time. Do this by first pressing the **OFF** button to turn off the door controls and all the lights. Leave the door powered by the AC adapter or battery when you do this. Then while holding down the **MANUAL OPEN** button, press and release the **INSIDE SENSOR** button. The **INSIDE** light will blink to indicate the feature has been enabled. When shipped from the factory, the automatic safety retract feature is enabled.

After Defeating or Enabling the feature, press the **ON** button to resume normal door operation.

PET COLLAR OPERATING INSTRUCTIONS

Your Power Pet door comes with a standard model MS-5 ultrasonic transmitter collar. Each collar includes a black round battery **TEST button** which illuminates a **red LED** when the battery is **OK**. If the LED fails to light up, battery replacement is necessary.

Note : To energize the MS-5 Collar, pull out and discard the PULL TAB which is protruding from the side of the collar.

If needed, remove the back plate screw and pry open the case, as shown in the **BATTERY REPLACEMENT** section on the next page, and pull out the PULL TAB. Discard the PULL TAB and close up the case.

ADJUSTING THE STRAP

1. Fasten the collar around your pet's neck so that it fits comfortably. In most cases there will be excess strap length.
2. With a soft pencil or magic marker, mark the amount of strap to be removed leaving at least one inch past the plastic buckle.
3. Remove the collar from your pet and cut off the excess strap at the mark.
4. **IMPORTANT NOTE :** To avoid fraying carefully heat the cut end with an open flame to melt and fuse the material.
5. Re-fasten the collar around your pet's neck so that it hangs loosely and comfortably (as shown below.)

Your High Tech Pet MS-5 transmitter collar will operate for 3 months on a single, easily replaceable battery.

Replacement batteries, part number **B-3V1A**, and replacement MS-5 collar straps and Deluxe Straps (as shown below) are available from our website at **www.hightechpet.com**.



INSTALLING / REPLACING THE MS-5 BATTERY

1. Unscrew and remove the back plate screw located on the back of MS-5 transmitter.



2. Pry the back plate off at the area shown in, "Pry Area" images below.

PRY AREA



*Use a small flat-blade screwdriver or metal nail file.

3. Remove the MS-5 back plate and note the battery position. It's important that the battery label faces up and is visible as shown below.

Non-label side of battery



Label side of battery

Silicone Gasket



INSTALLING / REPLACING THE MS-5 BATTERY

4. Remove and replace B3V1A battery.



5. Close back plate. Press on the back plate until the bottom and top of the back plate are flush with the front of the case and it snaps back into place.



6. Replace and tighten back screw.

Flush Back Plate

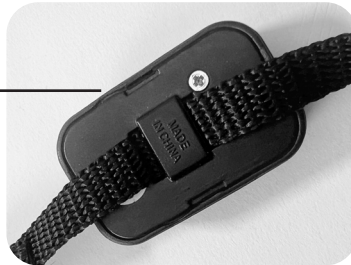

7. You are done!

REPLACING THE MS-5 BATTERY

WATER RESISTANCE

The High Tech Pet MS-5 ultrasonic transmitter collar is water resistant meaning that rainy weather and humidity will not damage the unit. These collars are **NOT** designed to be fully immersed in water. Should this occur, simply open the unit, shake out water and let dry. In most cases the unit will function normally. However the life of the battery will likely be reduced or the battery may require replacement.

TRAINING YOUR PET

Training your pet to use its new Power Pet door should be a relatively effortless task. Some pets may become startled by the sound and movement of the panel, but be patient. Nearly every pet will soon be used to the Power Pet's operation and learn to love using its own personal entry. We recommend that you lead your pet to the door and allow it to open several times to teach the animal the cause and effect relationship between pet and door. Then place a food / treat reward on the opposite side and lead the animal through the opening, allowing it to get the reward on the other side. Repeat several times. Before too long your pet will get the idea. If your pet doesn't get it in one sitting, remain patient and let your pet just walk around on its own for awhile. It won't take too much more time for your pet to realize the Power Pet door opens whenever the pet comes its way. One of the most frequent comments we hear from Power Pet owners is how much their pets love using their new Power Pet door. We are sure your pet will feel the same!

REPLACEMENT PARTS

Over the years you may need to replace damaged or worn out parts. High Tech Pet Products also offers complete refurbishment of the door at our facility in Ventura, Ca. Contact Customer Service for instructions on shipping your door back to us. For customers with the mechanical skills to refurbish themselves, we offer many replacement parts on our web site, www.hightechpet.com along with do-it-yourself instructions for replacement.

MANY CONVENIENT ACCESSORIES!

We have a great set of options to make your Power Pet door the most versatile pet door you'll find!

EXTRA PET COLLARS :

(Compatible with **ALL** Power Pet door models.)

Model MS-5 Ultrasonic Transmitter Collar



MS-5 Deluxe Collar with Strap and Boot



Model RX-10 Multi-Function Rechargeable Collar



POWER PET (PX) DOOR ACCESSORIES :

ALUMINUM WALL TUNNEL



Install your Power Pet door on any wall in one easy step with our convenient all aluminum wall adapter tunnel accessory which extends the passageway and provides a sealed professional installation. It fits snugly into the Power Pet Roll Up Door main frame on one side of the wall, and the outside frame on the other side. Works with walls up to 6 inches in depth. And multiple can be bridged together to accommodate a greater depth, as needed.

RECHARGEABLE BACKUP BATTERY

Install this heavy duty, long life, sealed 12 volt rechargeable battery in your Power Pet door to provide back-up power in case of an AC power outage. Provides hundreds of door openings to let your pet in or out until power returns. Automatically recharges in your door when plugged into AC power as well.

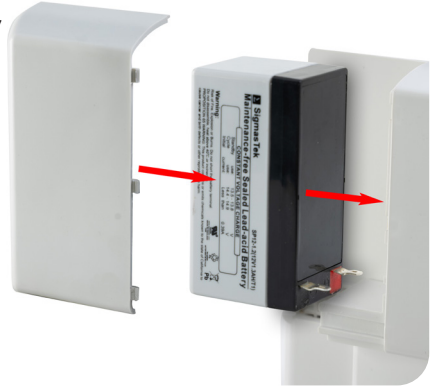

2 BATTERY CHARGER KIT (STANDARD PX DOORS ONLY)



For battery powering of the Power Pet PX door in installations where AC power is not available. This kit includes a battery charger with an AC adapter, 2 rechargeable batteries. Simply charge the battery for 12 hours and insert it in the door to provide one to four weeks of normal operation. Use one battery in your Power Pet door and keep the other in the charger. When your door battery runs low, just swap them out.

TROUBLESHOOTING GUIDE

For further assistance, please contact us at :

1-800-255-1279 - Monday - Friday - 6:30 am - 4:00 pm Pacific Standard Time.

PROBLEM	POTENTIAL RESOLVE
While opening, door stops rising and all lights turn off or blink.	1.) Replace the AC adapter. 2.) Replace the motor assembly.
Door panel goes up and down without stopping - LED lights on the control panel are flashing.	1.) Replace the main circuit board. 2.) Replace the main wire harness.
Very short range on both sensors. Outside sensor good, but inside sensor yields short or no range. Inside sensor good, but outside sensor yields short or no range. Manual button works, but inside and outside sensors yield short or no range. Manual button works, but door is not triggered by collar.	1.) Test all collars for proper function. 2.) Replace the main circuit board. 3.) Replace the dual sensor cable assembly.
Door goes up too slowly. Door sticks at top. Door panel goes up and down without stopping - LED lights on the control panel are all lit up as normal.	1.) Loosen all 8 mounting screws slightly. 2.) Clean sliding door with soap and water, then spray with dry lubricant. 3.) Replace the motor assembly. 4.) Replace the main circuit board.
Door does not open with manual open button or the collar.	1.) Replace the main circuit board.
Range is difficult to adjust to less than five or six feet.	1.) Replace main circuit board

PLEASE NOTE :

All of our repair and maintenance parts are available on our website at : **www.hightechpet.com**, along with DIY instructions for replacement.

If replacing an internal part, here are the inner workings of the **Power Pet (PX) door** you will see after removing the doors back panel.

1.) Remove the 8 mounting screws behind the screw cap covers to unmount your door.

2.) Then flip your door around and remove all screws around the back panel, then remove the back panel by gently prying around the edges.

NOTE : make sure to keep the back panel screws organized as there are different sized screws.

3.) You now have access to the inside of your Power Pet door as shown below.

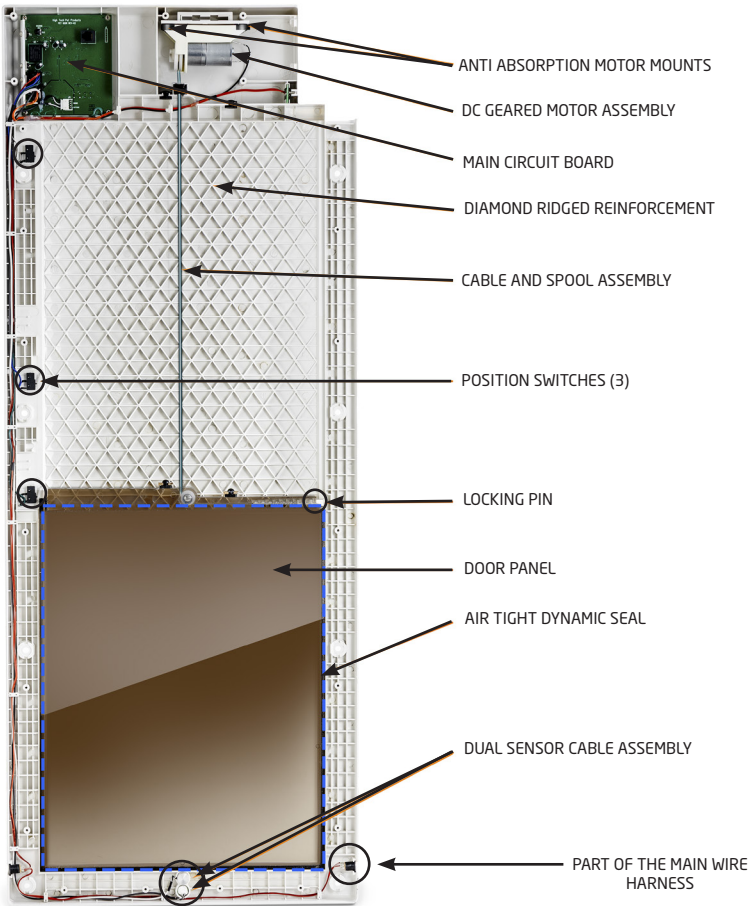

NOTES :

NOTES :

NOTES :

NOTES :

Help is right here!

We've got you. For general questions
and technical support call us at :

1-800-255-1279

Monday - Friday - 6:30 am - 4:00 pm
Pacific Standard Time



CAUTION :

As with any pet door, supervision of your pet at all times is advised. Failure to do so could result in harm to your pet. Please be sure provide proper accommodations indoors and outdoors as needed in the rare event that your pet door were to malfunction, along with a contingency plan.



High Tech Pet Products, Inc.

2111 Portola Rd. Suite A
Ventura, California 93003
www.hightechpet.com

