

Owner's Manual

Safariland™ User's Guide

Duty Gear Holsters

Models 6295/62955
6280/6285
2/200/2005
070/0705 SSIII
295/2955
6004
6005



3120 East Mission Boulevard
 Ontario, California 91761 U.S.A.
 Tel (909) 923-7300 Fax (909) 923-7400
 ©2014 Safariland, LLC

U/G-00000WHA-01 06/14

SAFARILAND™

Step 4
 To draw handgun, obtain a shooting grip with trigger finger extended straight. With thumb, push tab of thumb-break toward your body to release snap and at the same time, draw handgun straight up. A bit of resistance should be encountered until handgun is released from holster seat. **Regular practice to assure proficiency in using holster must be continued as long as it is to be used.** The amount of practice and training required will depend upon the dexterity, coordination and prior experience with holsters and handguns of each particular user.

CAUTION: Prior to wearing the holster on duty, the user must accomplish draw from fully snapped and secured holster in under two seconds while under simulated stress or life-threatening situation. Have a partner time you from surprise command to completed draw.

A handgun seated in a new holster will fit more tightly than after a reasonable break-in period has occurred. Thus, the holster should not be used with a loaded handgun or on duty until the under two-second drawing standard indicated above is accomplished by the user.

Should the holster remain tight after a reasonable break-in period, apply a liberal amount of common silicone spray to the inside of the holster.

CAUTION: Should the holster continue to bind or remain tight, **cease use immediately.** Contact Safariland's Customer Service at (800) 347-1200.

Step 5
 In an effort to enhance the service life of this holster, Safariland has developed a holster tensioning device which is the Allen head screw on the face of the holster. The tensioning device should be tested and adjusted as indicated below, prior to each wearing.

Place unloaded handgun in holster, leaving hammer strap unsnapped. With holster and/or duty rig in hand, turn holster upside down and shake. Shake holster and handgun 2 or 3 times at an intensity you believe duplicates running or other maneuvers normally encountered on patrol.

CAUTION: Be sure to shake holster over a very soft surface (e.g. mattress or thick chair cushion) so as not to cause damage if handgun should fall out. With wrench provided, turn tension device clockwise until handgun does not fall out when duplicating the procedure described above.

Next, and **most important**, place duty rig, holster and unloaded handgun on waist and draw gun as prescribed in this pamphlet. If the handgun should bind, or should your drawing motion be restricted in any way, loosen tensioning device enough to allow a smooth and normal draw. Repeat the entire procedure until you are satisfied with the handguns security in an unsnapped holster and in your ability to efficiently draw handgun.

Practice and training as prescribed in this pamphlet are mandatory prior to using the holster on duty. Do not use a loaded handgun during practice and training. Practice using the holster with an unloaded handgun until you are thoroughly competent and proficient in its safe use.

Regular practice to assure proficiency in using the holster must be continued as long as it is to be used. The amount of practice and training required will depend upon the dexterity, coordination and prior experience with holsters and handguns of each particular user.

Owner's Manual

Safariland™ User's Guide

Model 2, 200, 2005

Operating Instructions

Step 1
 In order to draw a handgun from Safariland Model 200 and 2005 holsters, it is necessary to install it on a 2-1/4" (58mm) wide duty belt.

If the holster is equipped with Safariland's belt tensioning system then loosen the belt tension screws with wrench provided, before placing holster on belt. Failure to do so may result in damage to the belt. Determine proper holster position on belt, check to see that there is not excessive pressure against patrol vehicle seat while seated. Turn tension screw clockwise until tension is felt. Do not over tighten. This system does not require excessive pressure. Tighten screws only enough to prevent holster from slipping on duty belt. For best results, tighten screw so that they are flush with the top of the belt loop.



Step 2
 Release snap on thumb-break and insert unloaded handgun straight down. When placing the handgun in the holster, do not place your finger in the trigger guard, or near the trigger. Position trigger finger adjacent to but away from the trigger and, if possible, support the tip of the finger on the front of the trigger guard. When putting handgun in the holster, always place the thumb over the hammer or behind the slide. Be certain handgun is thoroughly seated in holster.

Step 3
 After handgun is properly seated in holster, secure hammer strap. This may only be done by inserting male portion of snap into the lower edge of the female snap and rotating the female snap upward to complete closure. **This action should become very natural after practice. Steps 2 and 3 should be practiced until a one-handed holstering and snapping of hammer strap is smooth and natural.**

CAUTION: Never leave hammer strap unsecured. Any holster's retention capabilities are severely diminished if hammer strap is left unsecured.

Step 4
 To draw handgun, it is necessary to use a two step process. First, obtain a shooting grip with trigger finger extended straight and, with thumb, press the thumb tab down to release lock. Second, use the thumb to rotate hammer strap forward and clear of the handgun and hammer, and at the same time rotate butt of handgun forward approximately 1/4" (1.90cm) and then draw straight up. Do not attempt to drag the handgun forward like a traditional "break-front" holster. The Model 6295 is a front un-locking holster that must be drawn straight up after the locking device is cleared.

CAUTION: Never leave hammer strap unfastened. Any holster's retention capabilities are severely diminished if hammer strap is left unsecured.

Step 5
 After handgun is properly seated in holster, rotate hammer strap rearward over hammer to secure hammer. The thumb tab will lock into position. **This action should become very natural after practice. Steps 2 and 3 should be practiced until a one-handed holstering and securing of thumb tab/hammer strap is smooth and natural.**

CAUTION: Never leave hammer strap unfastened. Any holster's retention capabilities are severely diminished if hammer strap is left unsecured.

Step 1
 In order to draw a handgun from Safariland Model 6295 and 62955 holsters, it is necessary to install it on a 2-1/4" (58mm) wide duty belt.

If the holster is equipped with Safariland's belt tensioning system then loosen the belt tension screws with wrench provided, before placing holster on the belt. Failure to do so may result in damage to the belt. Determine proper holster position on belt, check to see that there is not excessive pressure against patrol vehicle seat while seated. Turn tension screw clockwise until tension is felt. Do not over tighten. This system does not require excessive pressure. Tighten screws only enough to prevent holster from slipping on duty belt. For best results, tighten screw so that they are flush with the top of the belt loop.

Step 2
 Push down on thumb tab area, and, while holding thumb tab down, rotate hammer strap forward, and insert-unloaded handgun straight down. A definite "Click" should be heard when handgun is in the holster, do not place finger in the trigger guard, or near the trigger. Position trigger finger adjacent to but away from the trigger and, if possible, support tip of finger on the front of trigger guard. When putting handgun in the holster, always place thumb over the hammer or behind the slide. Be certain handgun is thoroughly seated in holster.

Step 3
 After handgun is properly seated in holster, rotate hammer strap rearward over hammer to secure hammer. The thumb tab will lock into position. **This action should become very natural after practice. Steps 2 and 3 should be practiced until a one-handed holstering and securing of thumb tab/hammer strap is smooth and natural.**

CAUTION: Never leave hammer strap unfastened. Any holster's retention capabilities are severely diminished if hammer strap is left unsecured.

Model 6295/62955
Safariland™ User's Guide
Owner's Manual

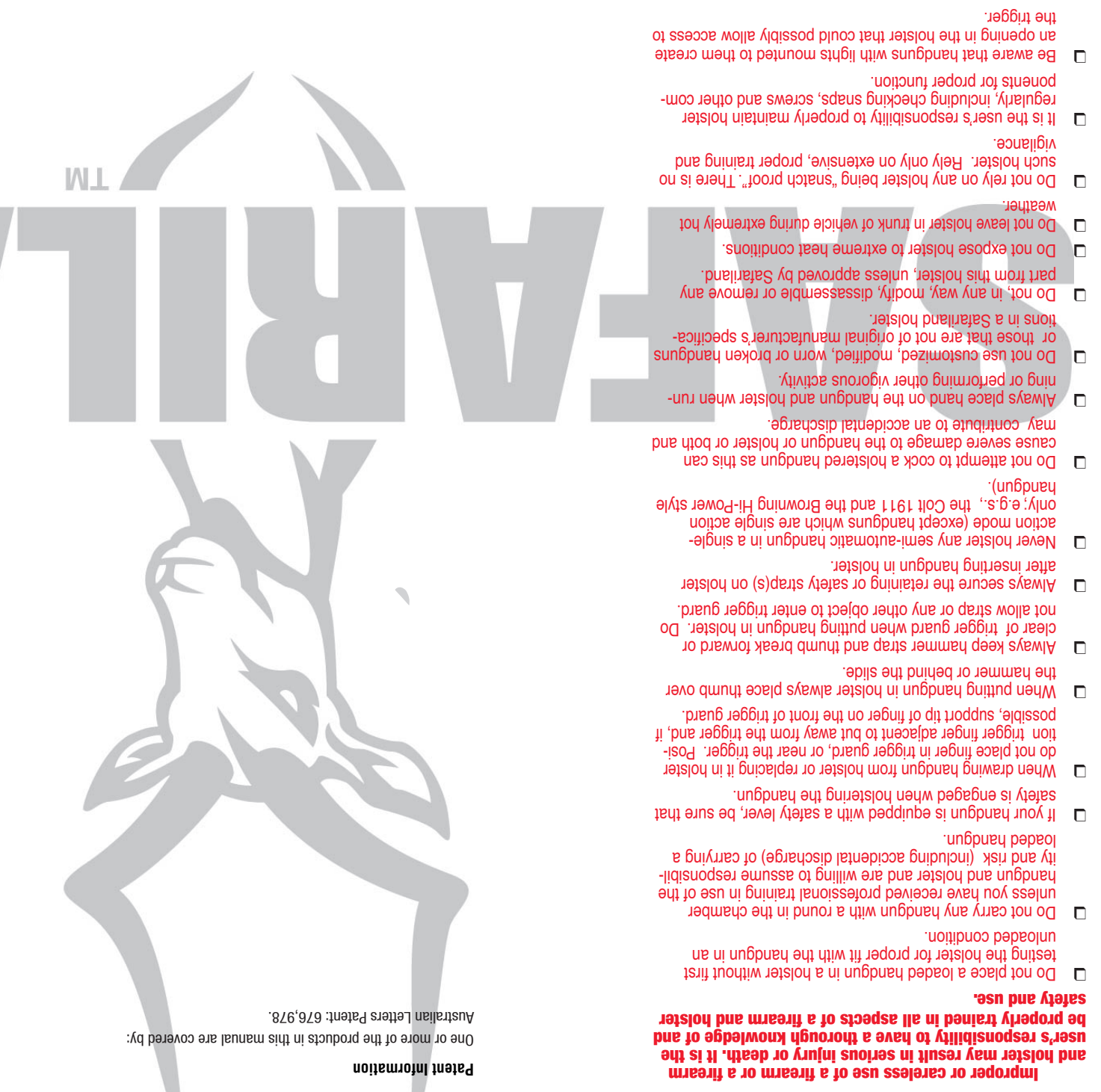

Safariland™ User's Guide
Owner's Manual

WRENCH PROVIDED FOR YOUR CONVENIENCE

Your holster is equipped with our holster tensioning device. The wrench provided should be used to tighten or loosen the tensioning device on your new holster. If the body retention is not to your liking, you may turn the allen head screw clockwise to tighten or counter clockwise to relieve body retention.

CAUTION: Be sure to shake holster over a very soft surface (e.g. mattress or thick chair cushion) so as not to cause damage if the unloaded handgun should fall out. With wrench provided, turn tension device clockwise until handgun does not fall out when duplicating the procedure described above.

Next, and most important, place holster and unloaded handgun on waist and draw gun as prescribed in this pamphlet. If the handgun should bind, or should your drawing motion be restricted in any way, loosen tension device enough to allow a smooth and normal draw. Repeat the entire procedure until you are satisfied with the handgun's security in an unsnapped holster and in your ability to efficiently draw the handgun.

Practice and training as prescribed in this manual are mandatory prior to using the holster on duty. Do not use a loaded handgun during practice and training. Practice using the holster with an unloaded handgun until you are thoroughly competent and proficient in its safe use.

Regular practice to assure proficiency in using the holster must be continued as long as it is to be used. The amount of practice and training required will depend upon the dexterity, coordination and prior experience with holsters and handguns of each particular user.



CAUTION: Pistol must be properly drawn to avoid severe and irreparable damage to holster. Rotate pistol forward until release of trigger lock mechanism is released then draw **straight up**.

CAUTION: Be certain the rotating hammer strap is clear of the handgun prior to drawing the handgun out of the holster. A bit of resistance should be encountered until handgun is released from holster seat.

CAUTION: Prior to wearing the holster on duty, the user must accomplish draw from fully secured holster in less than two seconds while under simulated stress or a life threatening situation. Have a partner time you from surprise command to completed draw.

A handgun seated in a new holster will fit more tightly than after reasonable break-in periods had occurred. Thus, the holster should not be used with a loaded handgun or on duty until the under two-second drawing standard indicated above is accomplished by the user. Should the holster remain tight after a reasonable break—in period, apply a liberal amount of common silicone spray to the inside of the holster.

CAUTION: Should the holster continue to bind or remain tight, **cease use immediately.** Contact Safariland's Customer Care at (800) 347-1200. Never disassemble or attempt to modify the holster.

CAUTION: Pistols from several manufacturers have finish variations on the inside of their trigger guards. These variations result in sharp edges cause damage to the Safariland Model 6295. If you find drawing difficult after five tries, **cease use immediately** and follow these steps:

- Use a light emery cloth to smooth the edges in the area.
- Use a light emery cloth to smooth the edges in the area.

Safariland assumes no responsibility for any damage to the pistol as a result of this procedure.

If after following the above procedure you find drawing from your 6295 difficult, return holster for credit.

***SEE PANEL FOR IMPORTANT INFORMATION OF CARE AND MAINTANCE OF THE SLS MECHANISM.**

- Improper or careless use of a firearm or a firearm and holster may result in serious injury or death. It is the user's responsibility to have a thorough knowledge of and be properly trained in all aspects of a firearm and holster safety and use.
- Do not place a loaded handgun in a holster without first testing the holster for proper fit with the handgun in an unloaded condition.
- Do not carry any handgun with a round in the chamber unless you have received professional training in use of the handgun and holster and are willing to assume responsibility and risk (including accidental discharge) of carrying a loaded handgun.
- If your handgun is equipped with a safety lever, be sure that safety is engaged when holstering the handgun.
- When drawing handgun from holster or replacing it in holster do not place finger in trigger guard, or near the trigger. Position trigger finger adjacent to but away from the trigger and, if possible, support tip of finger on the front of trigger guard.
- When putting handgun in holster always place thumb over the hammer or behind the slide.
- Always keep hammer strap and thumb break forward or clear of trigger guard when putting handgun in holster. Do not allow strap or any other object to enter trigger guard.
- Always secure the retaining or safety strap(s) on holster after inserting handgun in holster.
- Never holster any semi-automatic handgun in a single-action mode (except handguns which are single action only; e.g., the Colt 1911 and the Browning Hi-Power style handgun).
- Do not attempt to cock a holstered handgun as this can cause severe damage to the handgun or holster or both and may contribute to an accidental discharge.
- Always place hand on the handgun and holster when running or performing other vigorous activity.
- Do not use customized, modified, worn or broken handguns or those that are not of original manufacturer's specifications in a Safariland holster.
- Do not, in any way, modify, disassemble or remove any part from this holster, unless approved by Safariland.
- Do not expose holster to extreme heat conditions.
- Do not leave holster in trunk of vehicle during extremely hot weather.
- Do not rely on any holster being "snatch proof". There is no such holster. Rely only on extensive, proper training and vigilance.
- It is the user's responsibility to properly maintain holster regularly, including checking snaps, screws and other components for proper function.
- Be aware that handguns with lights mounted to them create an opening in the holster that could possibly allow access to the trigger.

Patent Information
 One or more of the products in this manual are covered by:
 Australian Letters Patent: 676,978.

Read and understand entire manual before using holster.

WARNING

Safariland™ User's Guide

Owner's Manual

Owner's Manual

Safariland™ User's Guide

Model 6280, 6285

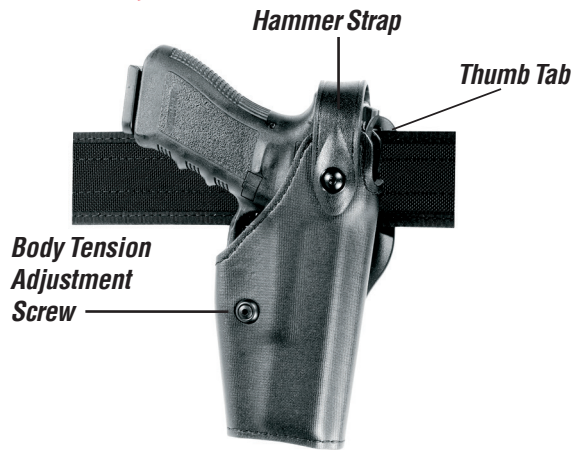

Your holster is equipped with our holster tensioning device. If the body retention is not to your liking, you may turn the allen head screw clockwise to tighten or counter clockwise to relieve body retention.

Operating Instructions

Step 1

In order to draw a handgun from Safariland Model 6280 and 6285 holsters, it is necessary to install it on a 2-1/4" (58mm) wide duty belt. If the holster is equipped with Safariland's belt tensioning system then loosen the belt tension screws with wrench provided, before placing holster on belt. Failure to do so may result in damage to the belt. Determine proper holster position on belt, check to see that there is not excessive pressure against patrol vehicle seat while seated. Turn tension screw clockwise until tension is felt. Do not over tighten. This system does not require excessive pressure. Tighten screws only enough to prevent holster from slipping on duty belt. For best results, tighten screws so that they are flush with the top of the belt loop. It is the user's responsibility to properly maintain holster, checking snaps, screws and other components for proper function.

Step 2

Push down on thumb tab area, and, while holding thumb tab down, rotate hammer strap forward, and insert unloaded handgun straight down. When placing handgun in the holster, do not place finger in trigger guard, or near the trigger. Position trigger finger adjacent to, but away from the trigger and, if possible, support tip of finger on the front of trigger guard. When putting handgun in the holster, always place thumb over the hammer or behind the slide. Be certain handgun is thoroughly seated in holster.

Step 3

After handgun is properly seated in holster, rotate hammer strap rearward over hammer to secure hammer. The thumb tab will lock into position. **This action should become very natural after practice. Steps 2 and 3 should be practiced until a one-handed holstering and securing of thumb tab/hammer strap is smooth and natural.**

Step 4

To draw handgun, it is necessary to use a two step process. **First**, obtain a shooting grip with trigger finger extended straight and, with thumb, press the thumb tab down to release lock. **Second**, use thumb to rotate hammer strap forward and clear of the handgun and hammer, and at the same time, draw handgun straight up. **Caution:** Be certain the rotating hammer strap is clear of the handgun prior to drawing the handgun out of the holster. A bit of resistance should be encountered until handgun is released from holster seat.

Step 5

In an effort to enhance the service life of this holster and provide a proper handgun fit, Safariland has developed a holster tensioning device which is the buttonhead screw on the face of the holster body. The tensioning device should be set so that handgun is firmly retained in holster. This tension adjustment screw should be tested and adjusted prior to each wearing as follows:

Place unloaded handgun in holster, leaving hammer strap unsnapped. With holster and/or duty rig in hand, turn holster upside down and shake. Shake holster and handgun 2 or 3 times at an intensity you believe duplicates running or other maneuvers normally encountered on patrol. Turn the tension adjustment screw clockwise to tighten or counter clockwise to relieve retention. Repeat the entire procedure until you are satisfied with the handguns security in an unsnapped holster and in your ability to efficiently draw handgun.

***SEE PANEL FOR IMPORTANT INFORMATION OF CARE AND MAINTENANCE OF THE SLS MECHANISM.**

Model 6004/6005

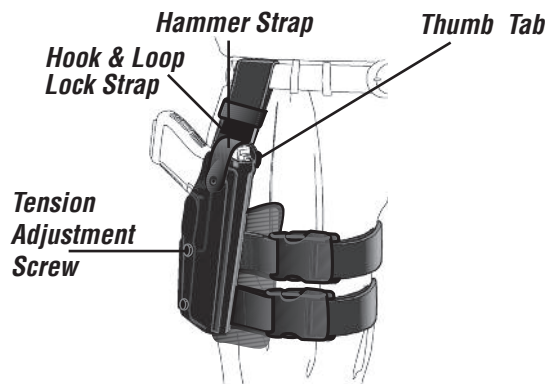

Operating Instructions

The Safariland Model 6004 and 6005 holster must be installed on a belt. Slide the belt through the upper Belt Loop portion of the holster. Next, place the leg strap around the upper portion of the thigh and adjust, making certain the holster is secure but not too tight. (See Illustration) **Note: 6005 has a detachable harness.**

Step 1

Remove the nylon hook and loop lock strap mounted to the vertical leg strap. The vertical leg strap incorporates hook and loop on the inside of the nylon. Adjust the position of the holster to the leg by releasing the and moving the strap up or down until the fit is comfortable. Reinstall the nylon hook and loop lock strap in the same manner that it was removed. Position the lock strap just below the belt. This will help keep the leg strap secure during movement.

Step 2

Push down on thumb tab area (Figure 1), while holding thumb tab down, rotate hammer strap forward (Figure 2), and insert unloaded handgun. When placing handgun in holster, do not place finger in trigger guard, or near the trigger. Position trigger finger adjacent to but away from the trigger and, if possible, support tip of finger on the front of trigger guard. When putting handgun in holster, always place thumb over the hammer or behind the slide. Be certain handgun is thoroughly seated in holster.

Step 3

After handgun is properly seated in the holster, slide hammer strap rearward to secure hammer. The thumb tab will lock into position. **This action should become very natural after practice. Steps 2 and 3 should be practiced until a one-handed holstering and securing of thumb tab/hammer strap is smooth and natural.**

Owner's Manual

Safariland™ User's Guide

Step 4

To draw handgun, it is necessary to use a two step process. **First**, obtain a shooting grip with trigger finger extended straight, and with thumb, push down on thumb tab and hold thumb tab down. **Second**, use thumb to rotate hammer strap forward and clear of handgun and, at the same time, draw handgun straight up. **Caution:** Be certain the rotating hammer strap is clear of the handgun prior to drawing the handgun out of the holster. A bit of resistance should be encountered until handgun is released from holster seat. **Regular practice to assure proficiency in using the holster must be continued as long as it is to be used. The amount of practice and training required will depend upon the dexterity, coordination and prior experience with holsters and handguns of each particular user.**

Step 5

In an effort to enhance the service life of this holster, Safariland has developed a holster tensioning device which is the buttonhead screw on the face of the holster. The tensioning device should be tested and adjusted as indicated below, prior to each wearing,

Place unloaded handgun in holster, leaving hammer strap unsnapped. With holster and/or duty rig in hand, turn holster upside down and shake. Shake holster and handgun 2 or 3 times at an intensity you believe duplicates running or other maneuvers normally encountered on patrol.

Turn the tension adjustment screw clockwise to tighten or counter clockwise to relieve retention. Repeat the entire procedure until you are satisfied with the handguns security in an unsnapped holster and in your ability to efficiently draw handgun.

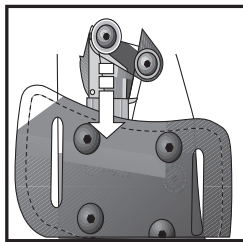

Figure 1

Push down on thumb tab and, while holding down, rotate forward.

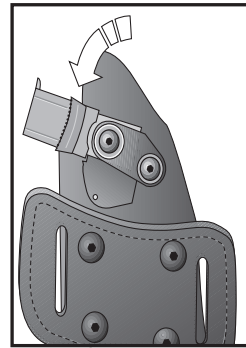

Figure 2

***SEE PANEL FOR IMPORTANT INFORMATION OF CARE AND MAINTENANCE OF THE SLS MECHANISM.**

Owner's Manual

Safariland™ User's Guide

Model 295 and 2955

Operating Instructions

Step 1

In order to draw a handgun from Safariland Model 295 and 2955 holsters, it is necessary to install it on a 2-1/4" (58mm) wide duty belt.

If the holster is equipped with Safariland's belt tensioning system then loosen the belt tension screws with wrench provided, before placing holster on belt. Failure to do so may result in damage to the belt. Determine proper holster position on belt, check to see that there is not excessive pressure against patrol vehicle seat while seated. Turn tension screw clockwise until tension is felt. Do not over-tighten. This system does not require excessive pressure. Tighten screws only enough to prevent holster from slipping on duty belt. For best results, tighten screws so that they are flush with the top of the belt loop.



Refer to Step 1 prior to installing holster on belt.

Step 2

Release snap on thumb-break and insert **unloaded** handgun **straight down**. A definite "click" should be heard when handgun is properly seated in holster.

When placing handgun in the holster, do not place finger in trigger guard, or near the trigger. Position trigger finger adjacent to but away from the trigger and, if possible, support tip of finger on the front of trigger guard. When putting handgun in the holster, always place thumb over the hammer or behind the slide. Be certain handgun is thoroughly seated in holster.

Step 3

After handgun is properly seated in holster, secure hammer strap. **This action should become very natural after practice. Steps 2 and 3 should be practiced until a one-handed holstering and snapping of hammer strap is smooth and natural.**

Step 4

To draw handgun, obtain a shooting grip with trigger finger extended straight. Release thumb-break as indicated above in Step 2. Rotate butt of handgun forward approximately 3/4" (1.90cm) and then draw straight up. Do not attempt to drag the handgun forward like a traditional "break-front" holster. The Model 295 is a front un-locking holster that must be drawn straight up after the locking device is cleared.

CAUTION: Pistol must be properly drawn to avoid **severe and irreparable** damage to holster. Rotate pistol forward until release of trigger lock mechanism is released, then draw **straight up**.

CAUTION: Pistols from several manufacturers have finish variations on the inside of their trigger guards. These variations result in sharp edges on the trigger guard which may affect drawing performance and/or cause damage to the Safariland Model 295.

Owner's Manual

Safariland™ User's Guide

If you find drawing difficult after five tries, **cease use immediately** and follow these steps:

- 1) Use a light emery cloth to smooth the edges in the area shown in the illustration. Safariland assumes no responsibility for any damage to the pistol as a result of this procedure.
- 2) If after following the above procedure you find drawing from your 295 difficult, return holster for credit.

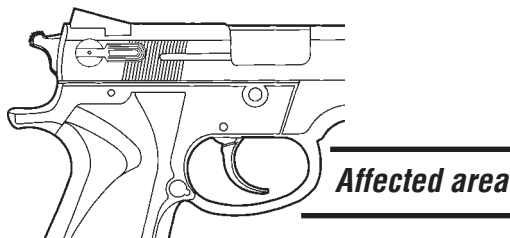

Care and Maintenance of the SLS Mechanism

The SLS mechanism is composed of stainless steel and chemically resistant plastic. It is designed with extra tolerances and clearing ports in order to function under extreme environmental conditions. Like the weapon it encloses, the SLS mechanism is a mechanical device and could require cleaning and lubrication if exposed to extremely dirty conditions. Testing has shown that conditions such as mud, dry sand, and airborne grit will cause additional force to operate the SLS rotating hood. Those same conditions usually render the weapon useless before the SLS rotating hood is affected.

If your holster and weapon have been exposed to such conditions, as soon as practicable clean the handgun per the manufacturer's instructions and then clean the SLS rotating hood system. If the SLS mechanism has been exposed to mud and the unit is still wet, flush with warm water while rotating the hood until the unit works smoothly then lubricate with any gun oil. If the SLS mechanism has been exposed to dry sand or grit, it should be cleaned with WD-40 or a similar aerosol product using the plastic straw nozzle while rotating the hood until the unit works smoothly, then lubricate with a gun oil. As a practical matter inspect, clean and lubricate the SLS mechanism every time you inspect, clean and lubricate your handgun.

Congratulations on your Safariland purchase. You have selected a product with construction technology that is unique and state of the art in the manufacturing of holsters, belts and accessories.

The product you have received is constructed with one or more of the following materials; a soft glove leather, natural suede and/or SafariLaminate™. Care and maintenance of this product is dictated by the material from which it is constructed. Use of an incorrect cleaning material will result in damage to the finish of the product.

SafariLaminate™ can be cleaned by wiping with a clean damp cloth. A paste type leather polish may be used to clean and protect the leather portions of the product. Products manufactured with suede can be cleaned by brushing with a soft brush. Do not use spray lacquer on any product as it will damage the finish.

CAUTION: Practice and training as prescribed in this manual are mandatory prior to using the holster on duty. Do not use a loaded handgun during practice and training. Practice using the holster with an unloaded handgun until you are thoroughly competent and proficient in its safe use.

CAUTION: Be sure to shake holster over a very soft surface (e.g. mattress or thick chair cushion) so as not to cause damage if the unloaded handgun should fall out. With wrench provided, turn tension device clockwise until handgun does not fall out when duplicating the procedure described above.

Next, and most important, place holster and unloaded handgun on waist and draw gun as prescribed in the pamphlet. If the handgun should bind, or should your drawing motion be restricted in anyway, loosen tensioning device enough to allow a smooth and normal draw. Repeat the entire procedure until you are satisfied with the handguns security in an unsnapped holster and in your ability to efficiently draw the handgun.

CAUTION: Never leave hammer strap unsecured. Any holster's retention capabilities are severely diminished if hammer strap is left unlocked.

CAUTION: Prior to wearing the holster on duty, the user must accomplish the draw from fully secured holster in less than two seconds while under simulated stress or a life-threatening situation. Have a partner time from a surprise command to a completed draw.

A handgun seated in a new holster will fit more tightly than after a reasonable break-in period has occurred. Thus, the holster should not be used with a loaded handgun or on duty until the under two-second drawing standard indicated above is accomplished by the user. Should the holster remain tight after a reasonable break-in period, apply a liberal amount of common silicone spray to the inside of the holster.

CAUTION: Should the holster continue to bind or remain tight, **cease use immediately**. Contact Safariland's Customer Care at (800) 347-1200. **Never dis-assemble or attempt to modify the holster.**

Regular practice to assure proficiency in using the holster must be continued as long as it is to be used. The amount of practice and training required will depend upon the dexterity, coordination and prior experience with holsters and handguns of each particular user.

The purchase and use of this Safariland holster is done at the sole and exclusive risk of the user.

Model 070/0705 SSIII

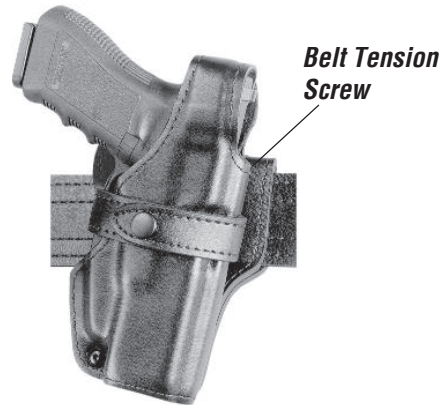

Operating Instructions

Step 1

In order to draw a handgun from the Safariland Model 070 and 0705 holster, it is necessary to install it on a 2 1/4" (60mm) wide duty belt. This holster is equipped with Safariland's exclusive belt tensioning system.

Loosen belt tension screws before placing holster on belt. Failure to do so may result in damage to belt. Loosen tension screws with wrench provided and slide holster on belt. After determining proper holster position, turn tension screws clockwise until tension is felt. Do not over-tighten. This system does not require excessive pressure. Tighten screws only enough to prevent holster from slipping on duty belt. For best results, tighten screws so that they are flush with the top of the belt loop.

Loosen belt tension screws before removing holster from belt. Failure to do so may result in damage to belt.

It is the user's responsibility to properly maintain holster, checking snaps, screws and other components for proper function.

Step 2

Release snaps on thumb-break and middle finger release strap. Note that the third snap is a decoy and does not release even though it appears designed to do so. Insert unloaded handgun. Always place thumb on hammer or behind slide and keep fingers clear of trigger when holstering a handgun. Place your index finger on the outside of the trigger guard, shielding the trigger. Be certain handgun is thoroughly seated in holster.

Step 3

After handgun is properly seated in holster, secure trigger guard strap first. Secure the hammer strap by inserting male portion of snap into the lower edge of the female snap and rotating the female snap upward to complete closure. **This action should become very natural after practice. Steps 2 and 3 should be practiced until a one-handed holstering and snapping process is smooth and natural.**

Step 4

To draw handgun, obtain a shooting grip with trigger finger extended straight. With thumb, rotate tab of thumb-break toward your body and, at the same time, release trigger guard strap. Rock handgun rearward 3/8" (.952cm) to clear internal locking mechanism. For best results, keep your elbow straight back. Don't allow your elbow to swing out away from your body. Doing so will cause undue resistance on handgun until released from holster. **Regular practice to assure proficiency in using holster must be continued as long as it is to be used. The amount of practice and training required will depend upon the dexterity, coordination and prior experience with holsters and handguns of each particular user.**

Step 5

Have a partner release one of the holster straps without indicating which one. Next, quickly draw on command. Your hand must automatically detect the new condition and release the remaining strap before drawing.

It is important to draw the handgun from various body and hand positions at least 100 times before using on duty. You may need to do this more times if the process feels unnatural or not smooth.

WARNING! Never store your Safariland holster or accessories near a heat source. Space heaters, radiators, heating registers, fireplaces, or other heating sources emit high temperatures that can deform or destroy the polymer from which many Safariland products are manufactured. The non-reflective surface on Safariland products will efficiently absorb radiant heat and can reach temperatures in excess of 200 degrees Fahrenheit, even several feet away from certain heating sources.

Caution: Exposure to high heat can cause them to deform, and in some cases can cause the weapon to be locked in place.

If you have accidentally exposed your equipment to a heat source, you should immediately remove it from the area, allow it to cool to room temperature and then operate it to insure correct function.

It is important to note that most natural and man-made products may eventually "wear out" or become unsuitable for the function for which they were designed. Stress and strain placed on any given holster will vary according to usage; therefore it is difficult to indicate a recommended replacement date for this product. It is the user's responsibility to assure, after use, that the holster is able to continue service within its design parameters.

Read and understand all owners manuals, instructions, and guides prepared by the manufacturer for your handgun.

It is the user's responsibility to inspect the holster daily for signs of excessive wear, or loss of retention of the handgun, and tightness of all screws and hardware. If any possible problem is detected or any doubt exists, do not use. Call Safariland's Customer Care at (800) 347-1200 or (909) 923-7300.

Failure to heed these warnings or follow the operating instructions may result in accidental discharge of a handgun causing serious injury or death.

Safariland holsters are designed to carry specific handguns. Before use, be sure holster selected is designed to carry corresponding handgun. If there is any doubt, do not use holster. Contact Safariland's Customer Care at (800) 347-1200 or (909) 923-7300. Carrying a handgun in an ill-fitting or improper holster can result in serious injury or death.