



SKY RIDGE - 20023

AWNING

INSTALLATION INSTRUCTIONS



270° AWNING

Congratulations on your purchase of the Pike 270° Awning. Your awning is designed to be mounted directly to your roof rack or aftermarket roof bars. It deploys and fully setup in just a few minutes. The Awning is made using the best materials and construction methods that will provide excellent protection from the elements.

WARNING

Incorrect installation or use of your awning could result in damage to awning, furthermore, serious injury or death. Please follow these installation instructions carefully to ensure proper installation on your vehicle. It is recommended that you contact your vehicle or accessory manufacturer for specified loading capacity of your roof rack. Unfortunately, not all factory roof racks, or aftermarket roof bars can safely accommodate all models.

Accessory add ons, such as awnings can change the normal vehicle handling. The purchaser assumes all risks and responsibility in case of any accidents due to improper use, improper maintenance, or checking the tightness of the brackets regarding the installation of the roof rack system.

Inspection: It is recommended that you regularly check all nuts and bolts related to the mounting system of your awning and vehicle that they are tight and in good repair, prolonged use on rough and corrugated terrain will require more regular inspection.

Structural Integrity: The Awning is Self-Supporting and is designed for general camping under normal conditions and is recommended that the supplied guy ropes are used to provide additional support at the end of each arm.

To avoid the chance of damage or injury it is recommended that the awning should not be erected during windy conditions. We recommend to conceal the awning past 25mph winds. Damage caused by incorrect installation or adverse weather conditions will not be covered by warranty

CLEANING & STORAGE

- Use cold water with a soft bristle brush, DO NOT use Soaps, Bleaches, or any other abrasive cleaners as this may result in damage to the fabric.
- Avoid storing your awning&walls when wet. If conditions dictate that you do, open, and dry out as soon as possible to avoid mildew.

SAFETY WARNING

- KEEP ALL FLAME AND HEAT SOURCES AWAY FROM THE AWNING&WALL MATERIALS. UNDER NO CIRCUMSTANCE SHOULD ANY NAKED FLAME SOURCES OR HEATING DEVICES BE USED INSIDE OR EAR THE AWNING
- DO NOT OPERATE ANY DEVICE WHICH BURNS FUEL INSIDE. KEEP EXIT CLEAR.

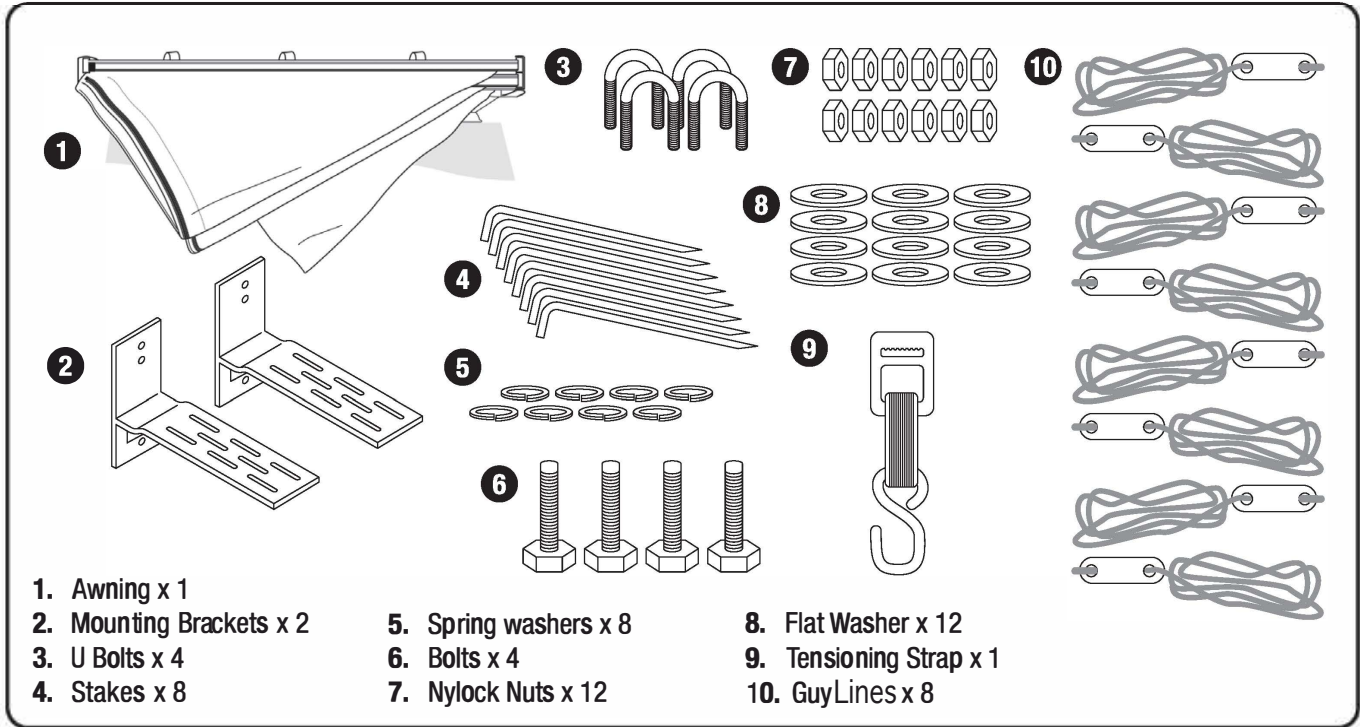

Mounting 270° Awning to your Vehicle

It is recommended that the awning is assembled and installed by two (2) people and further recommendations would be to have the awning installed by an experienced 4x4accessory installer.

The awning brackets supplied have been designed to fit the most common configurations of roof racks and rail systems, however due to the ever-increasing variations being offered by vehicle and accessory manufacturers. We cannot 100% guarantee that these will fit all available options.

It is recommended that you speak to your roof rack specialist for further advice or recommendations on the best system for your requirements.

ENSURE that the minimum spacing between the mounting brackets is to be 47" to allow the awning to be supported correctly and the weight is evenly distributed.

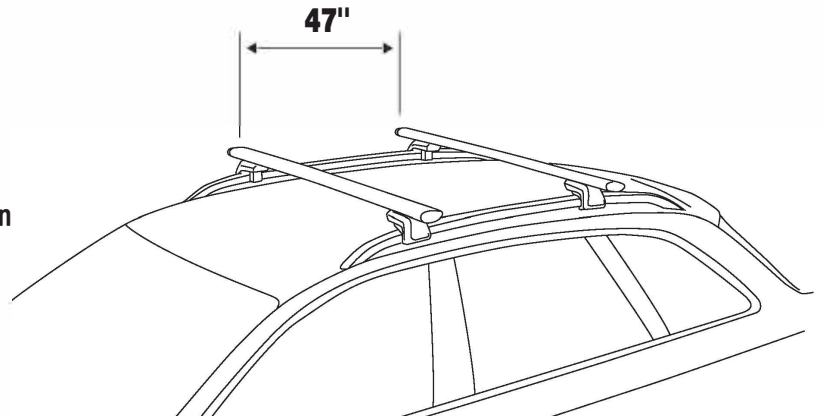

Step 1:

Unvelcro the PVC cover at each end of the awning and insert the bolts into the backing plate and reattach the end covers.

Step 2:

Position and attach the brackets in the required position using the Nylock nuts and washers then tighten.

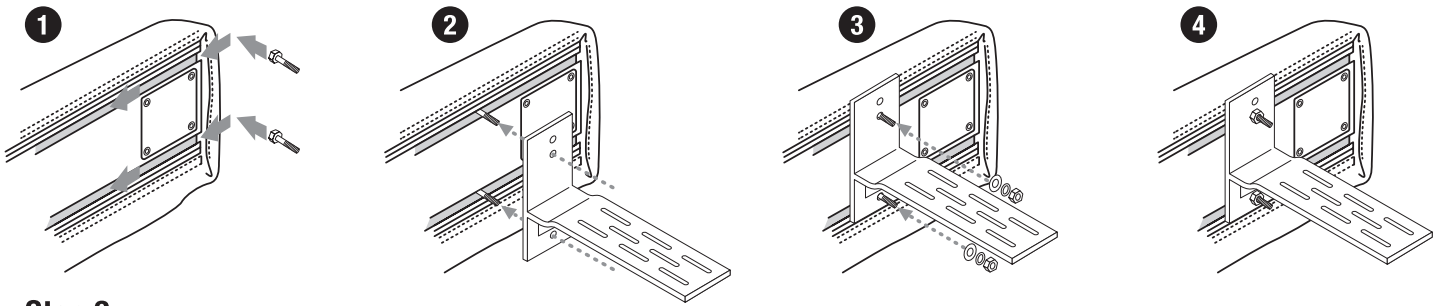

Step 3:

Mount to the vehicle using the U Bolts, Nylock nuts & Washers.

Assembly

Step 1:

Unzip the protective cover and fold back from the awning.

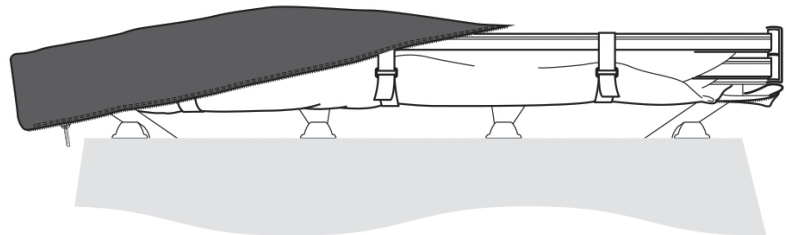

Step 2:

Undo the three supporting straps and release the fabric, take note of how the fabric is layered to assist with pack up.

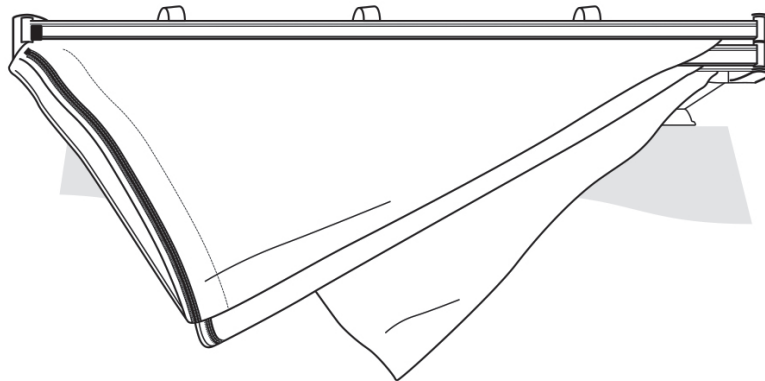
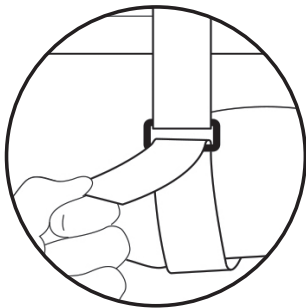

Step 3:

The fabric should now be draped in a triangle shape, grab the fabric at the point of the triangle and roll towards the top of the awning then secure with the straps. Position the PVC cover over the fabric and zip up.

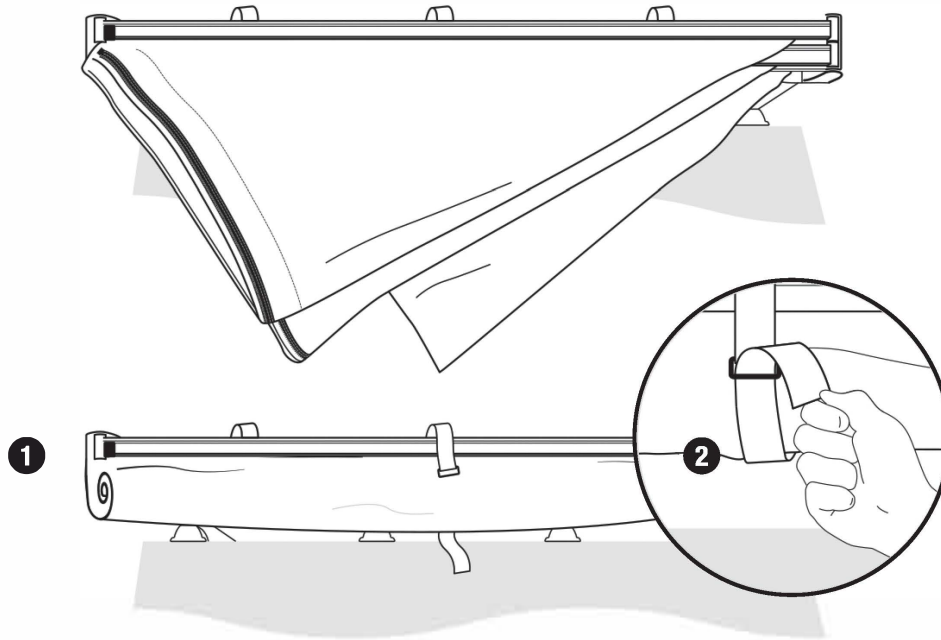
**USING OPTIONAL WALL KITS**

IMPORTANT: Support Poles & Guy Lines must be in place when fitting wall kits, failure to do so will result in damage to your awning.

Lay out the walls and locate where you require the door or window to be located, attach the Velcro at the top of the walls to the Velcro on the inside of the awning roof. Secure to the ground using the supplied guy lines & stakes.

It is recommended that wall kits are not installed during windy or adverse weather conditions as these may cause damage.

Step 3:

Swing the arms away from the awning until the fabric is fully extended towards the front & rear of the vehicle, use the Tensioning strap to secure the awning in position at the front & rear of the vehicle.

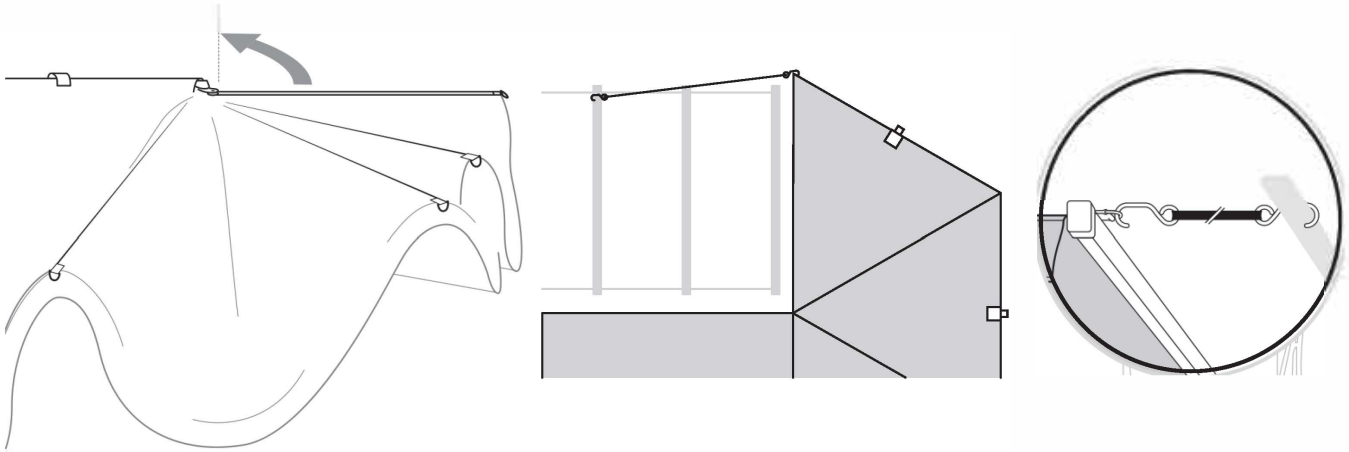
**Step 4:**

If being used in adverse weather conditions or if additional stability is required, release the support poles secured to the roof frame and adjust the pole height to the ground and attach the guy-lines & stakes.

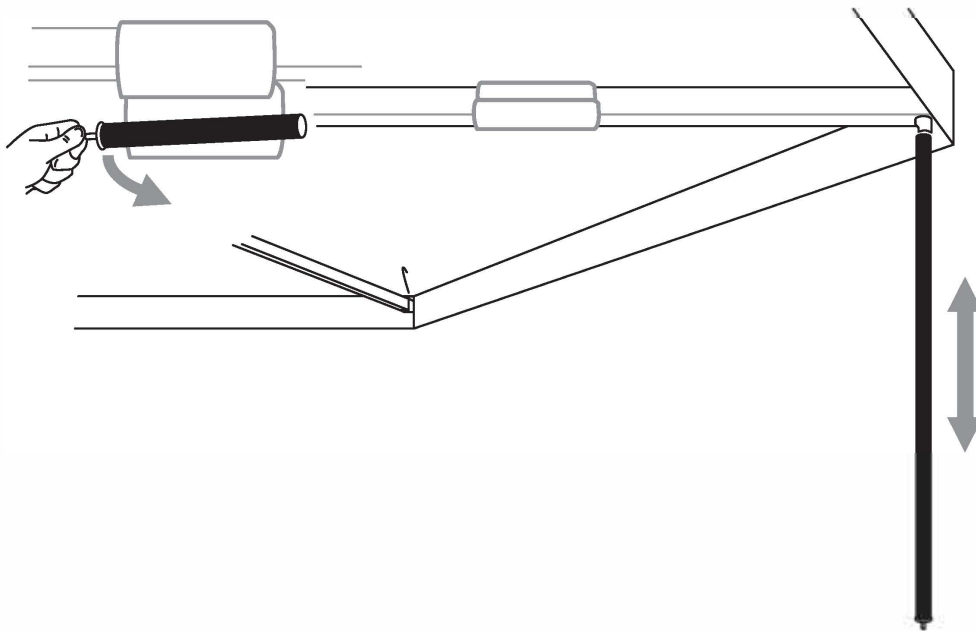

In the event of rain, it is recommended that support poles are height adjusted to allow a slight slope to the roof area and the additional guy ropes are attached to form a valley between each roof frame.

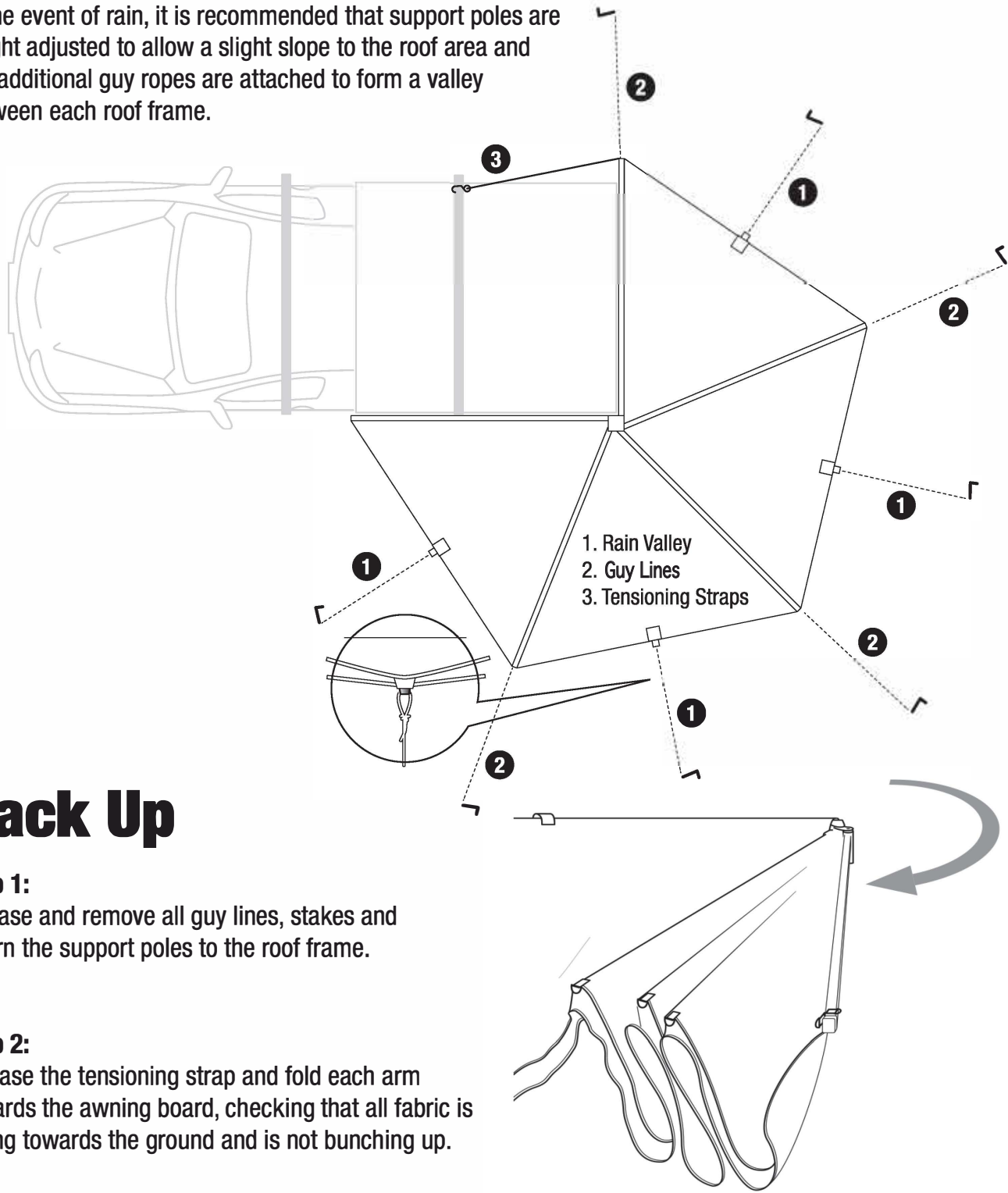

Pack Up

Step 1:

Release and remove all guy lines, stakes and return the support poles to the roof frame.

Step 2:

Release the tensioning strap and fold each arm towards the awning board, checking that all fabric is falling towards the ground and is not bunching up.