

SINGLE FRAME

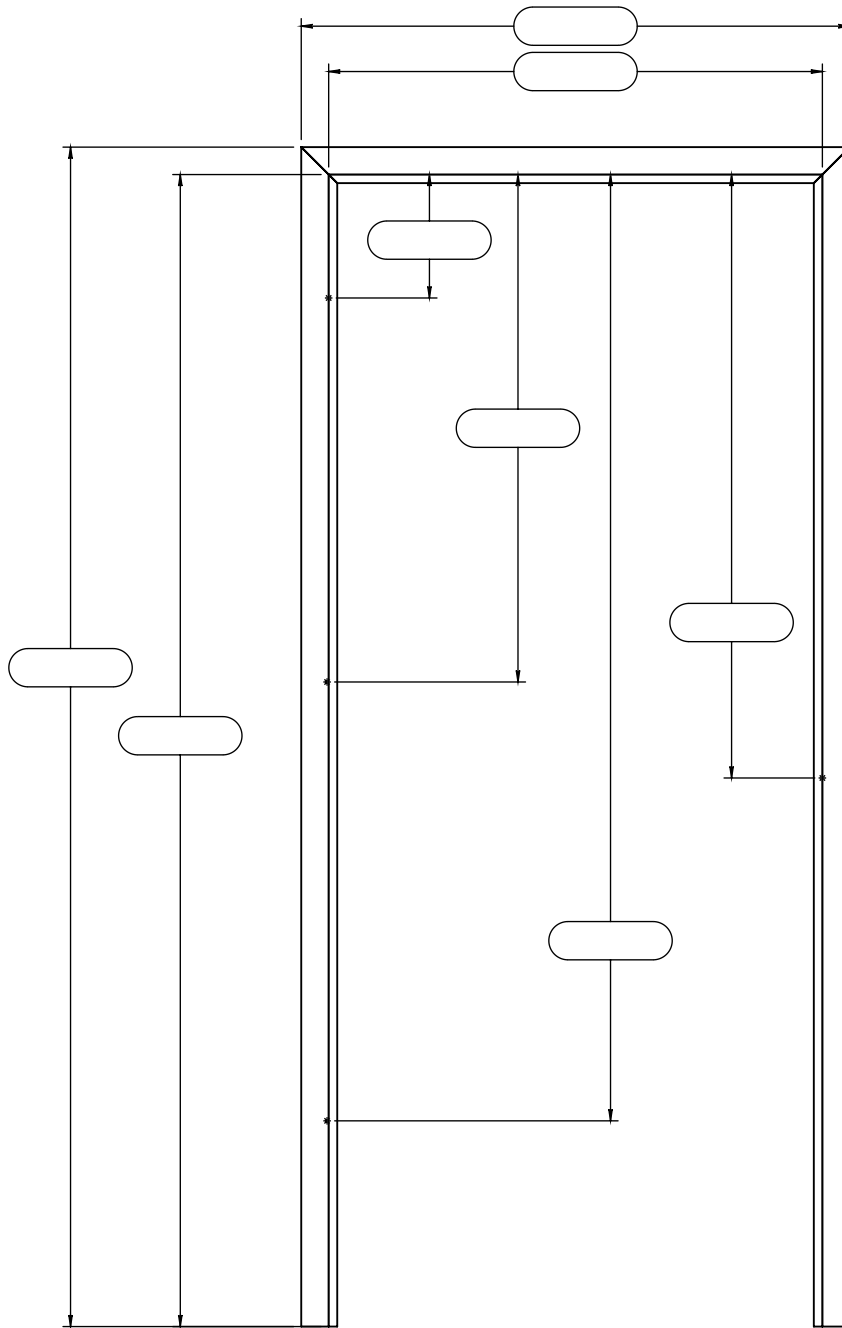

Material:	Handing:	Jamb Depth:	Locations:
Fire Label:	Construction	Mark #:	Notes:

PAIR FRAME

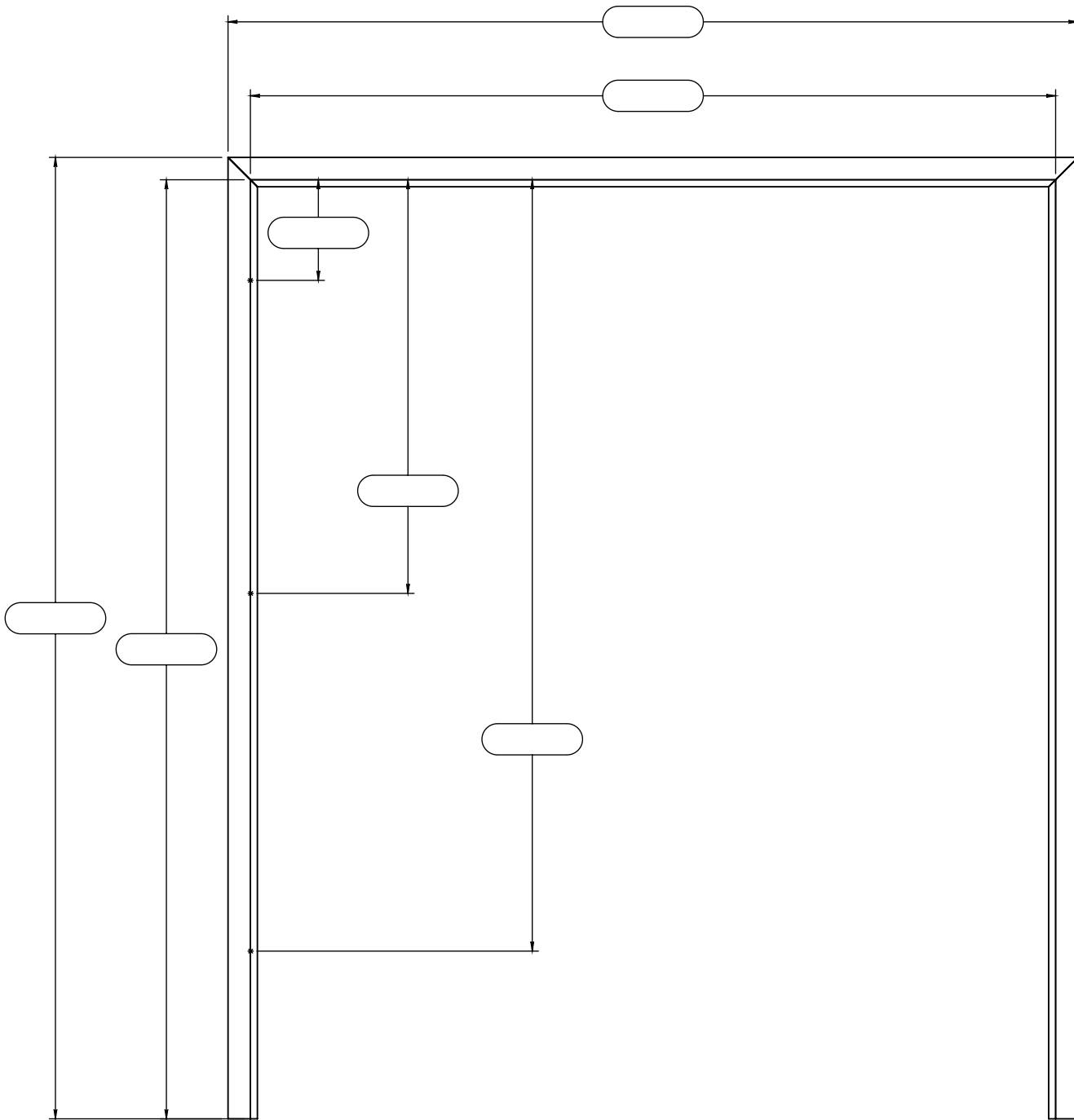

Material:	Handing:	Jamb Depth:	Locations:
Fire Label:	Construction	Mark #:	Notes:

1BL FLOOR MOUNT

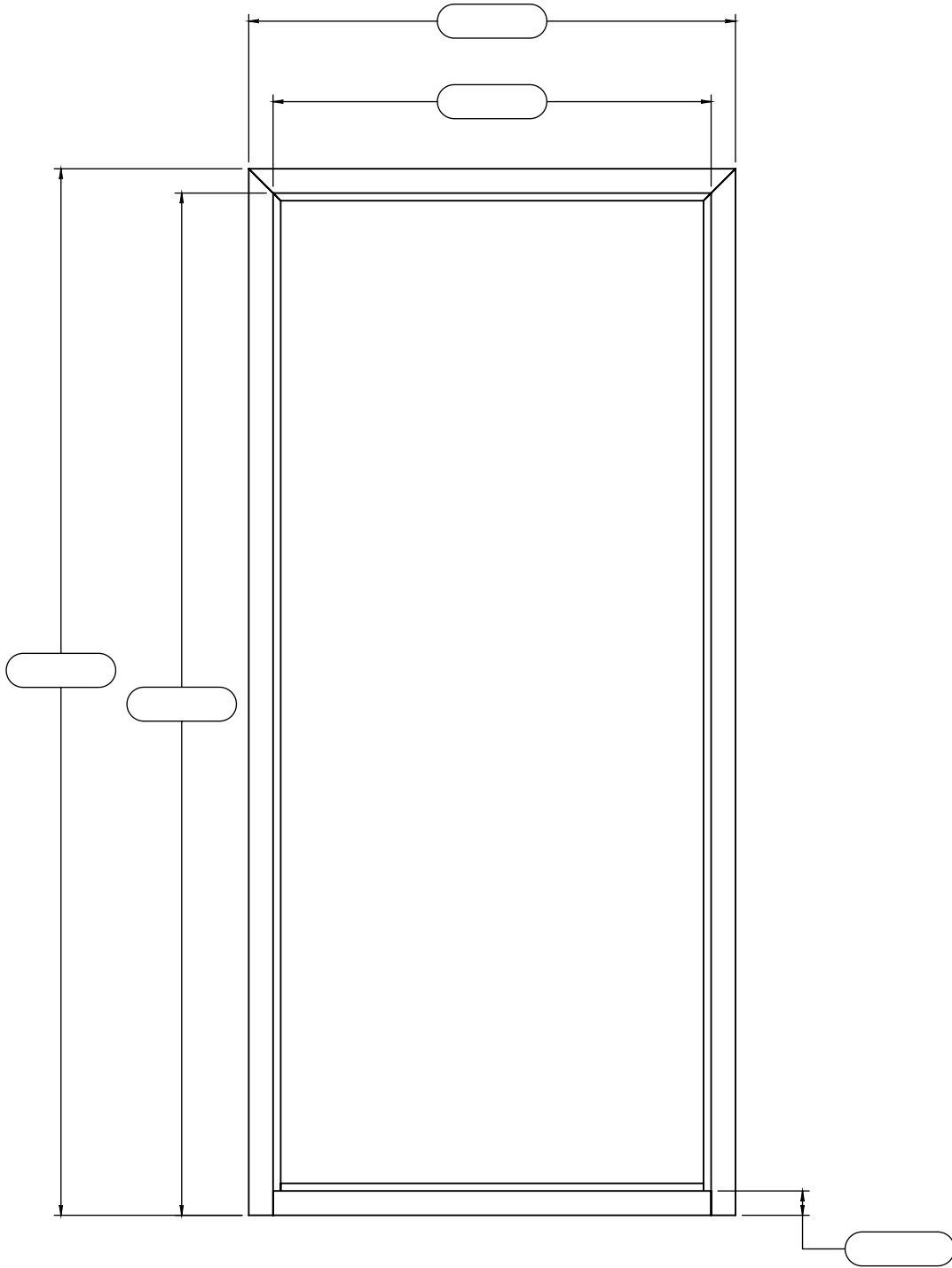

Material:	Handing:	Jamb Depth:	Locations:
Fire Label:	Construction	Mark #:	Notes:

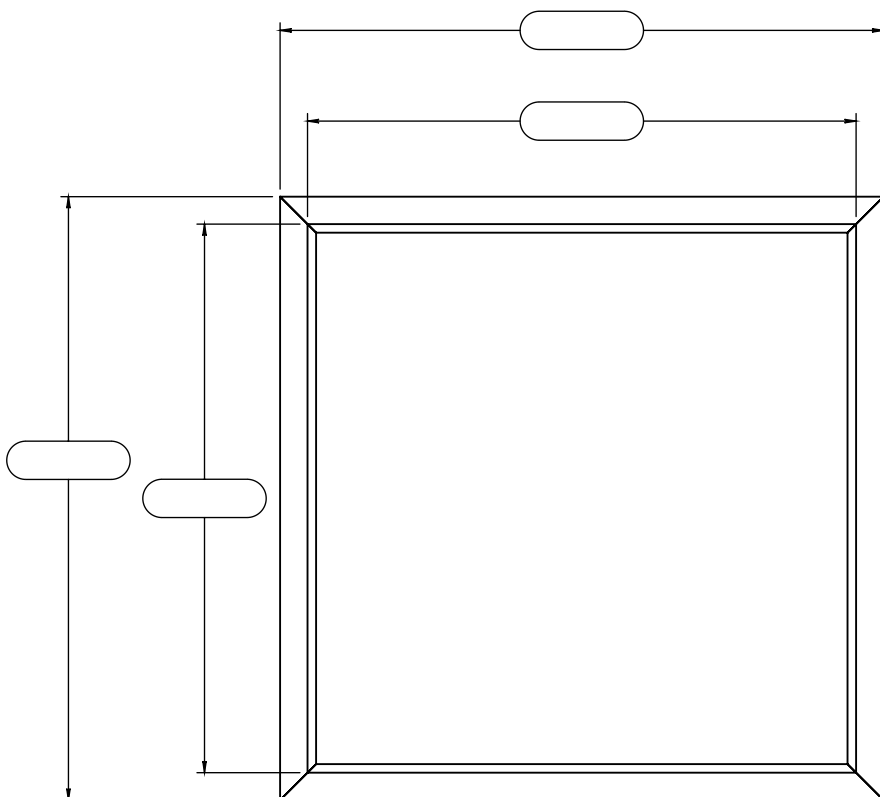

Material:	Handing:	Jamb Depth:	Locations:
Fire Label:	Construction	Mark #:	Notes:

2BL

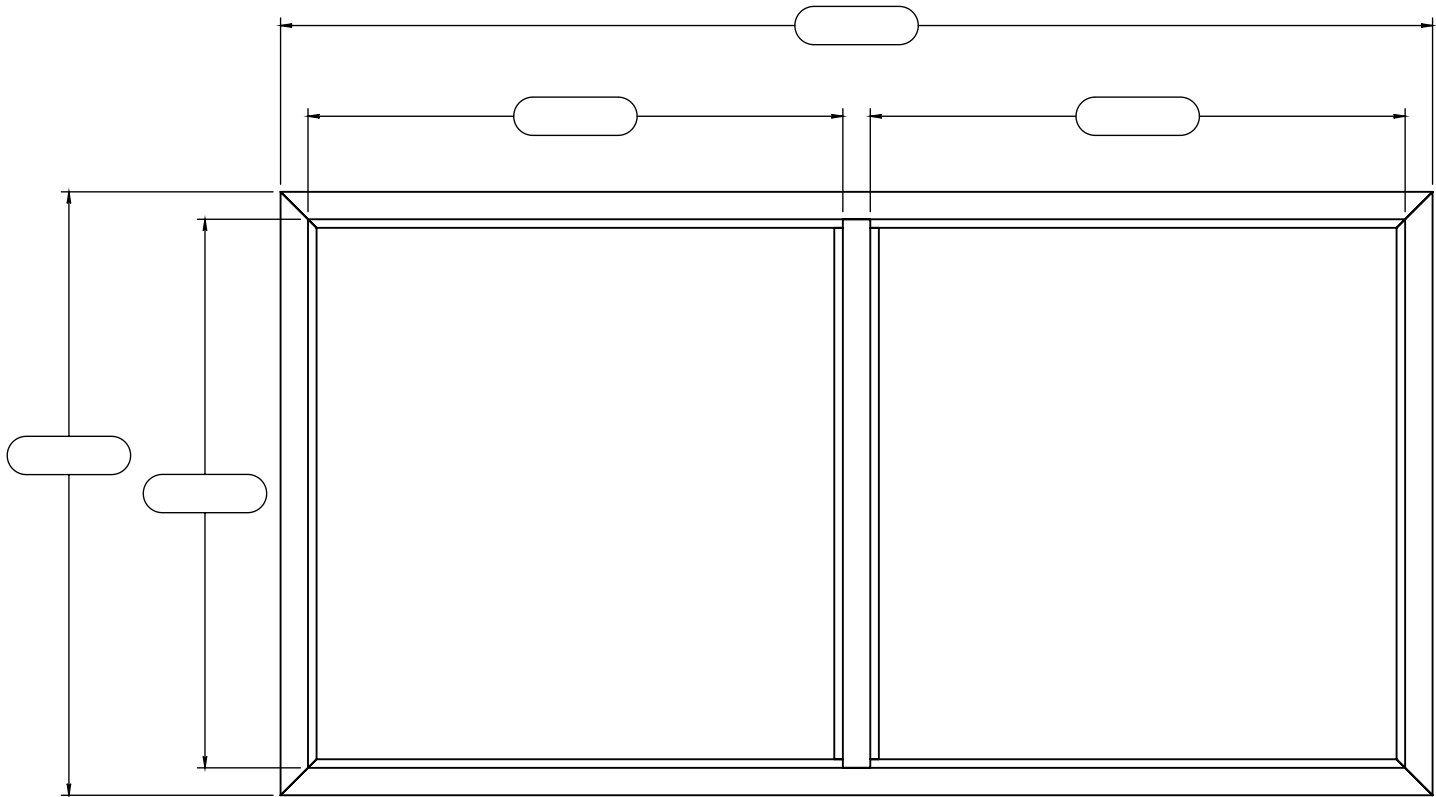

Material:	Handing:	Jamb Depth:	Locations:
Fire Label:	Construction	Mark #:	Notes:

3BL

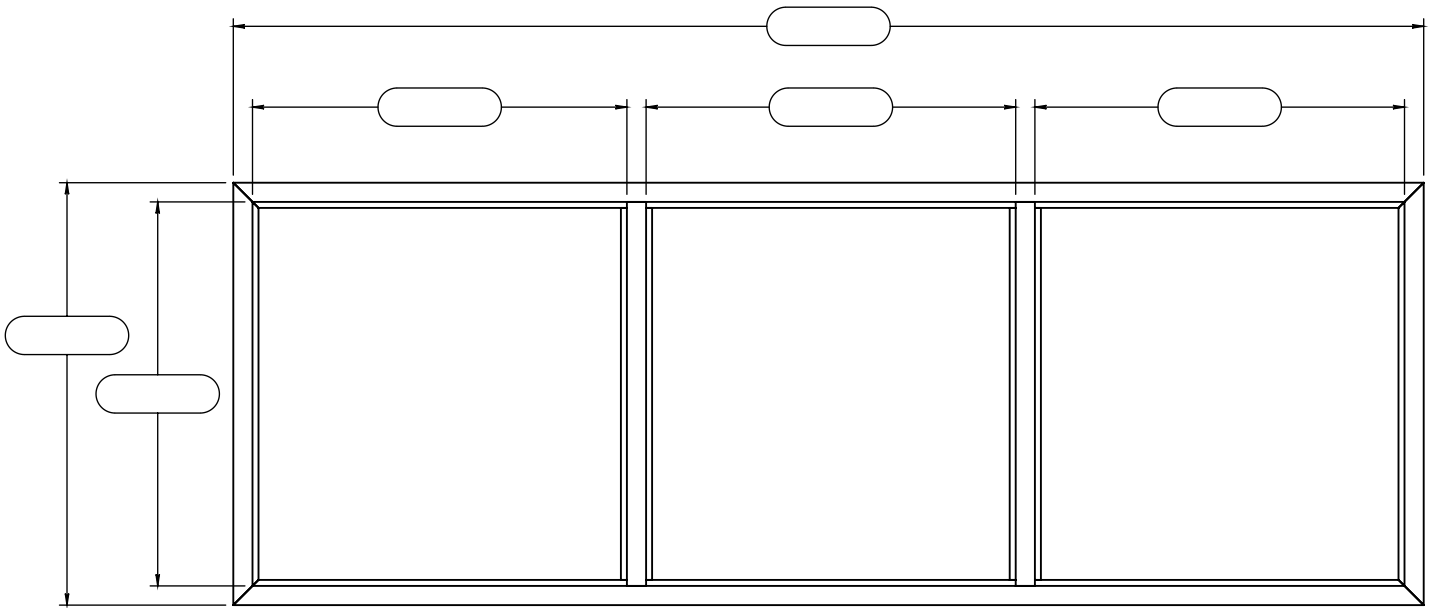

Material:	Handing:	Jamb Depth:	Locations:
Fire Label:	Construction	Mark #:	Notes:

4BL

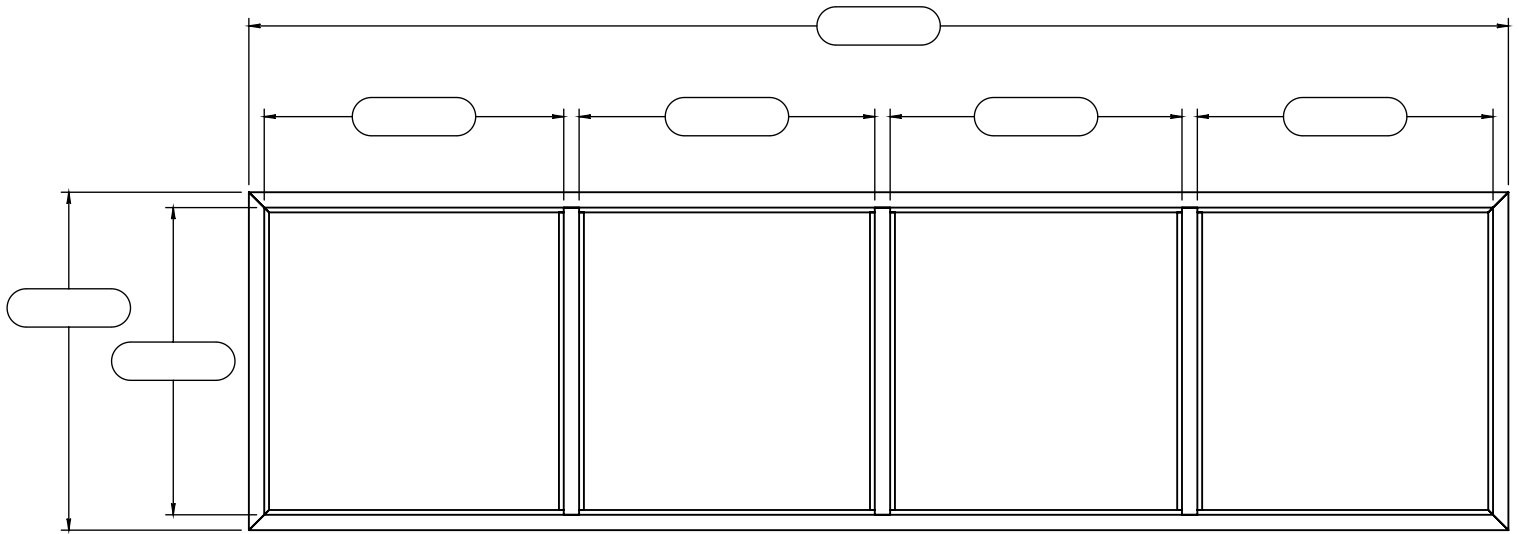

Material:	Handing:	Jamb Depth:	Locations:
Fire Label:	Construction	Mark #:	Notes:

2X2 BL

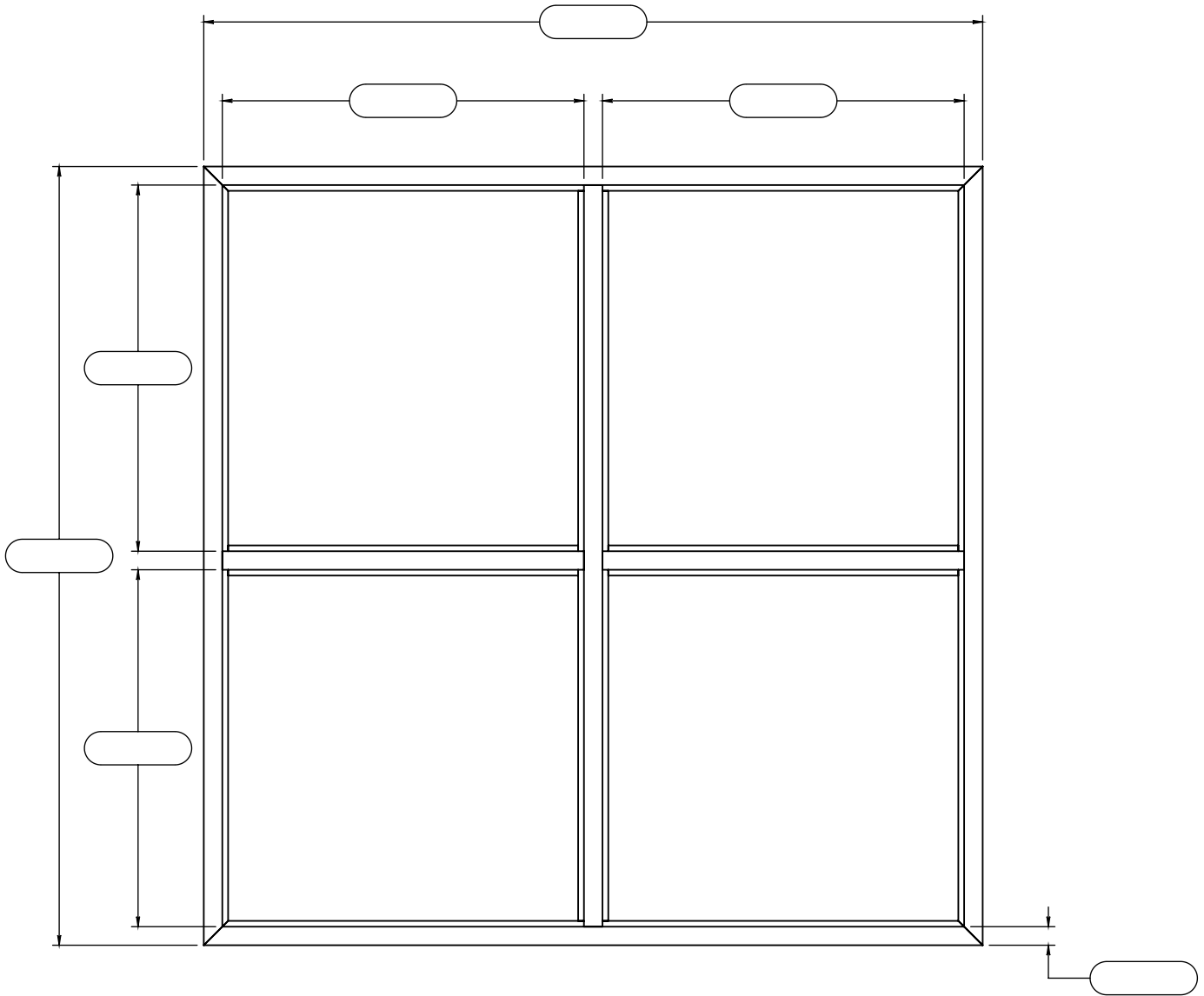

Material:	Handing:	Jamb Depth:	Locations:
Fire Label:	Construction	Mark #:	Notes:

3X2 BL

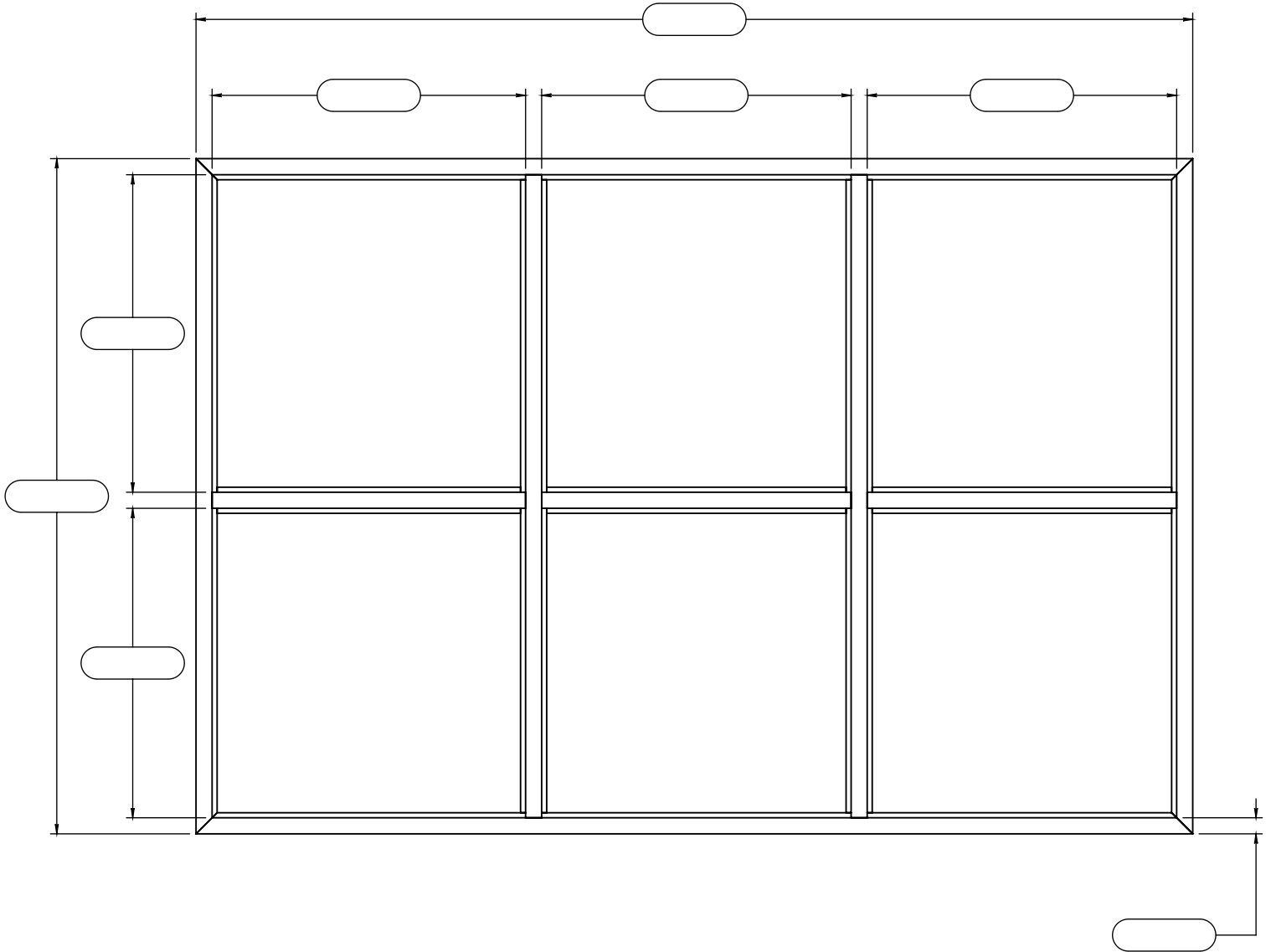

Material:	Handing:	Jamb Depth:	Locations:
Fire Label:	Construction	Mark #:	Notes:

4X2 BL

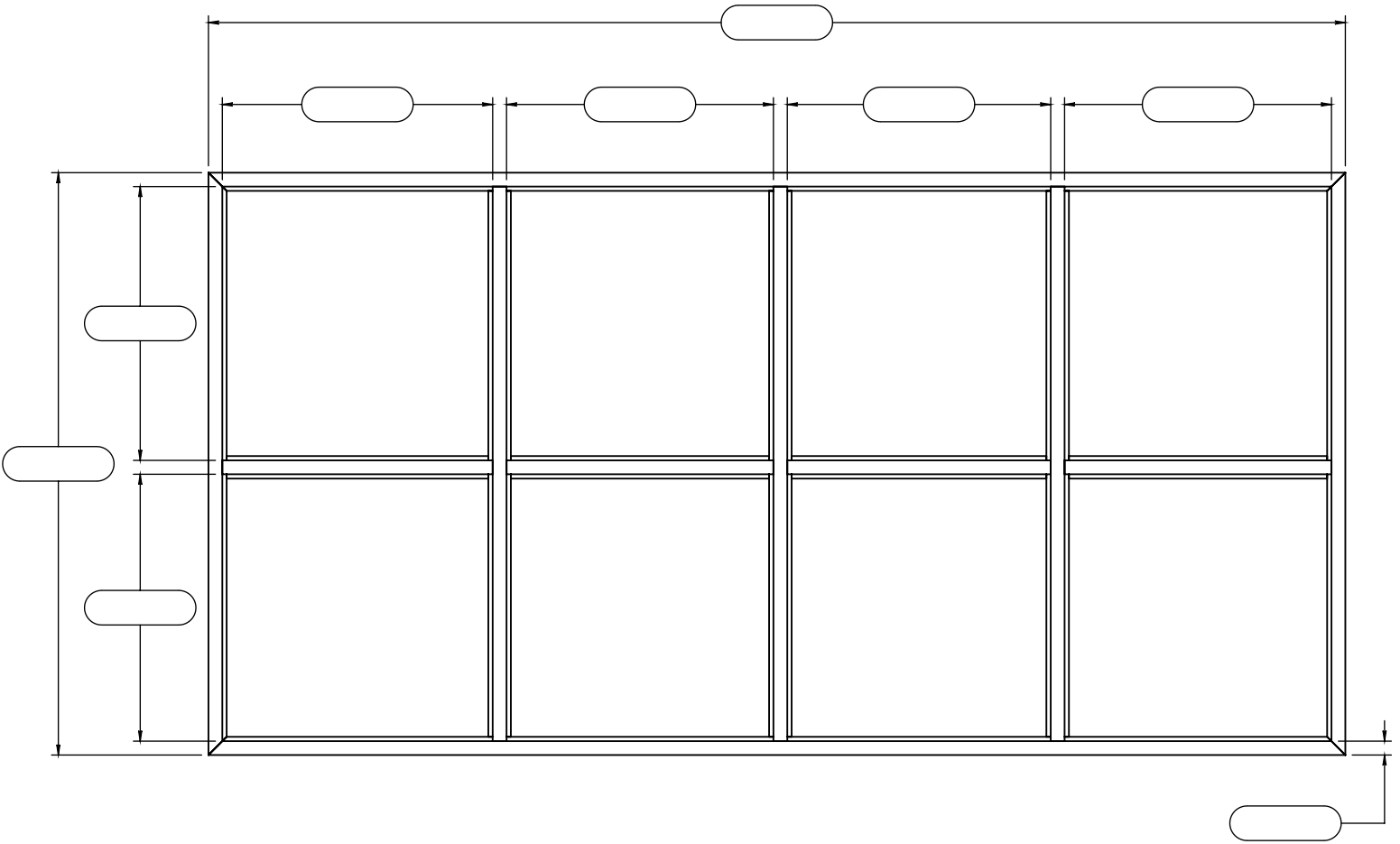

Material:	Handing:	Jamb Depth:	Locations:
Fire Label:	Construction	Mark #:	Notes:

SINGLE SIDELITE

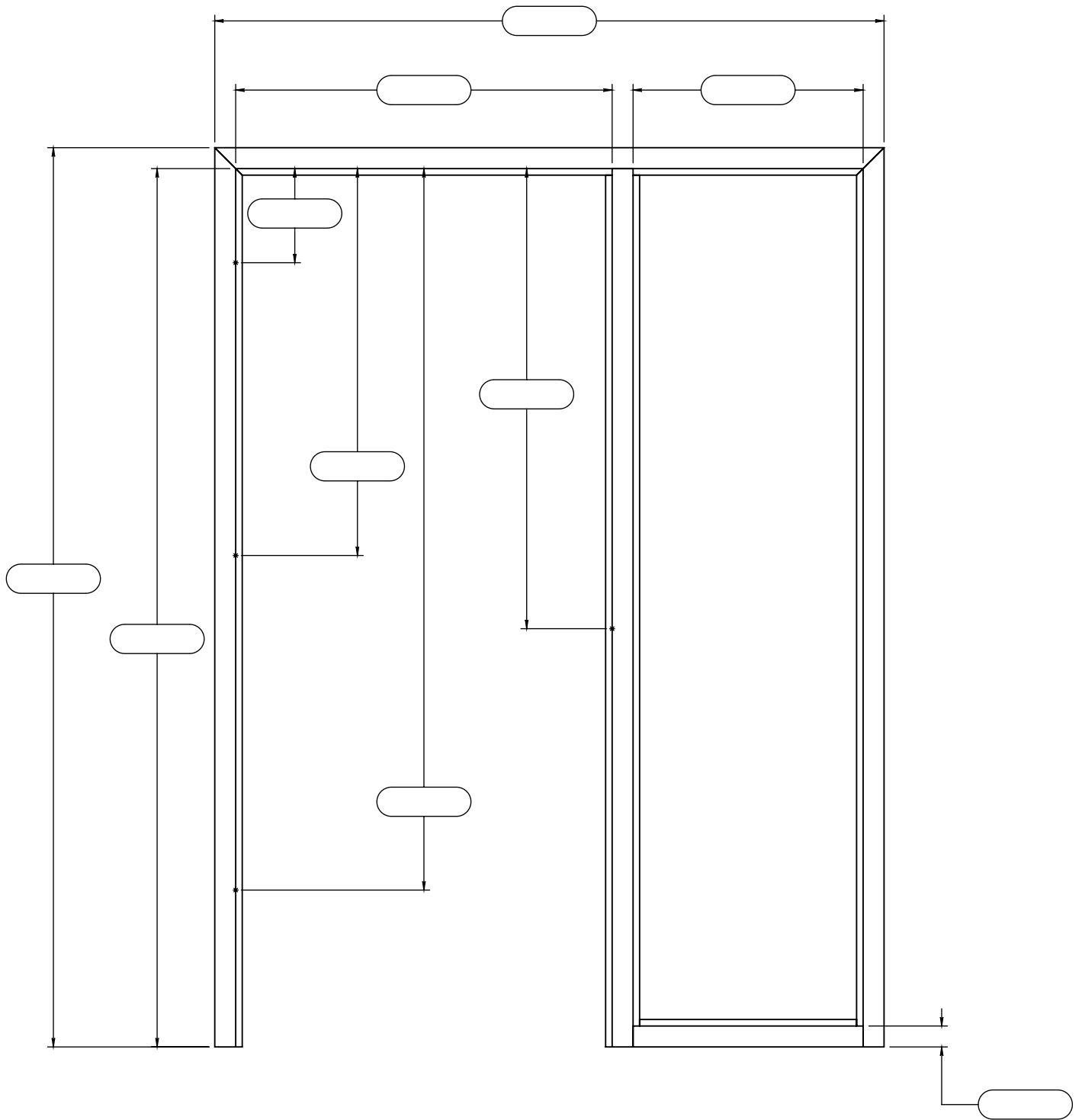

Material:	Handing:	Jamb Depth:	Locations:
Fire Label:	Construction	Mark #:	Notes:

SINGLE SIDELITE 1 HM

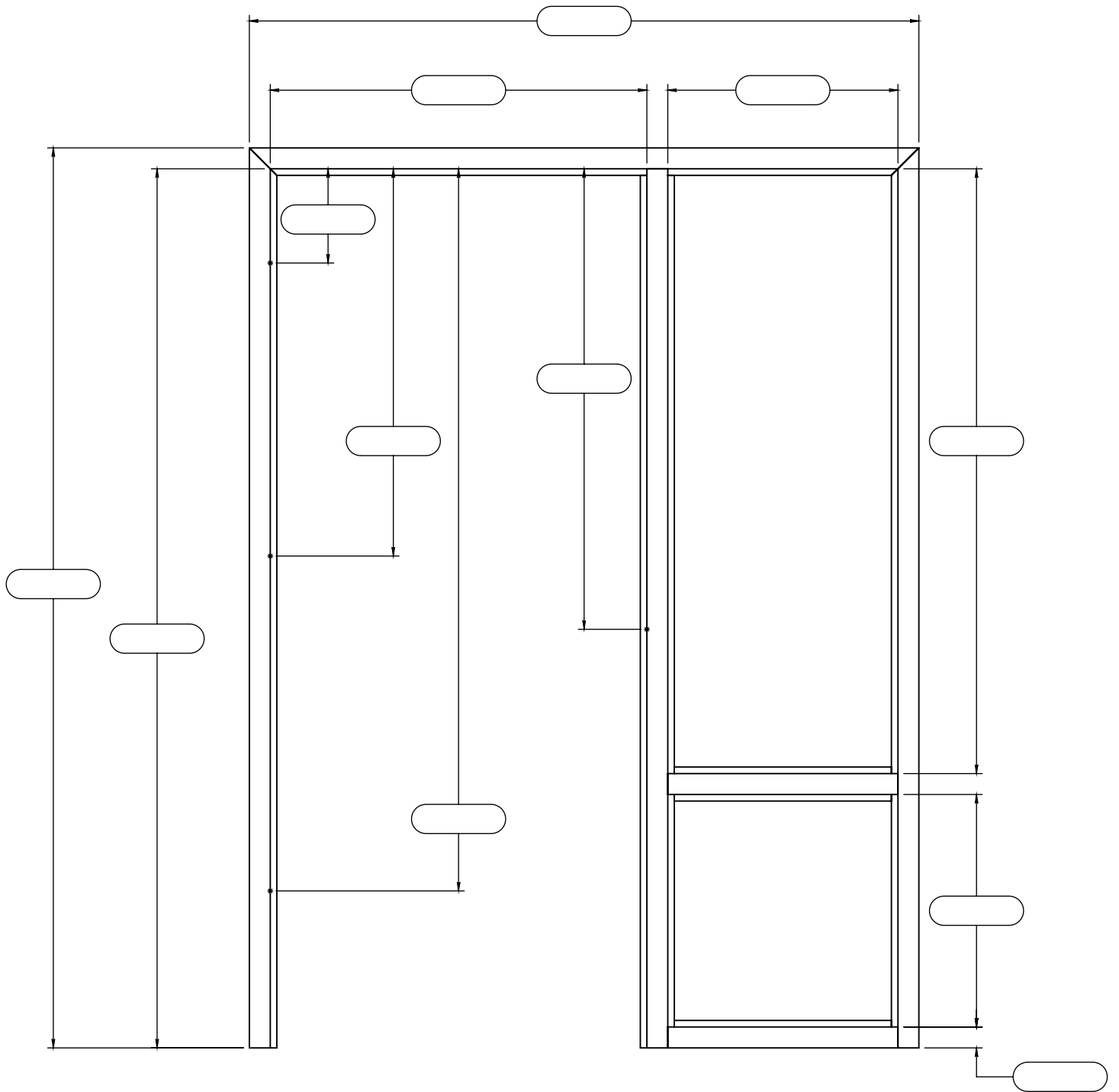

Material:	Handing:	Jamb Depth:	Locations:
Fire Label:	Construction	Mark #:	Notes:

SINGLE SIDELITE 2 HM

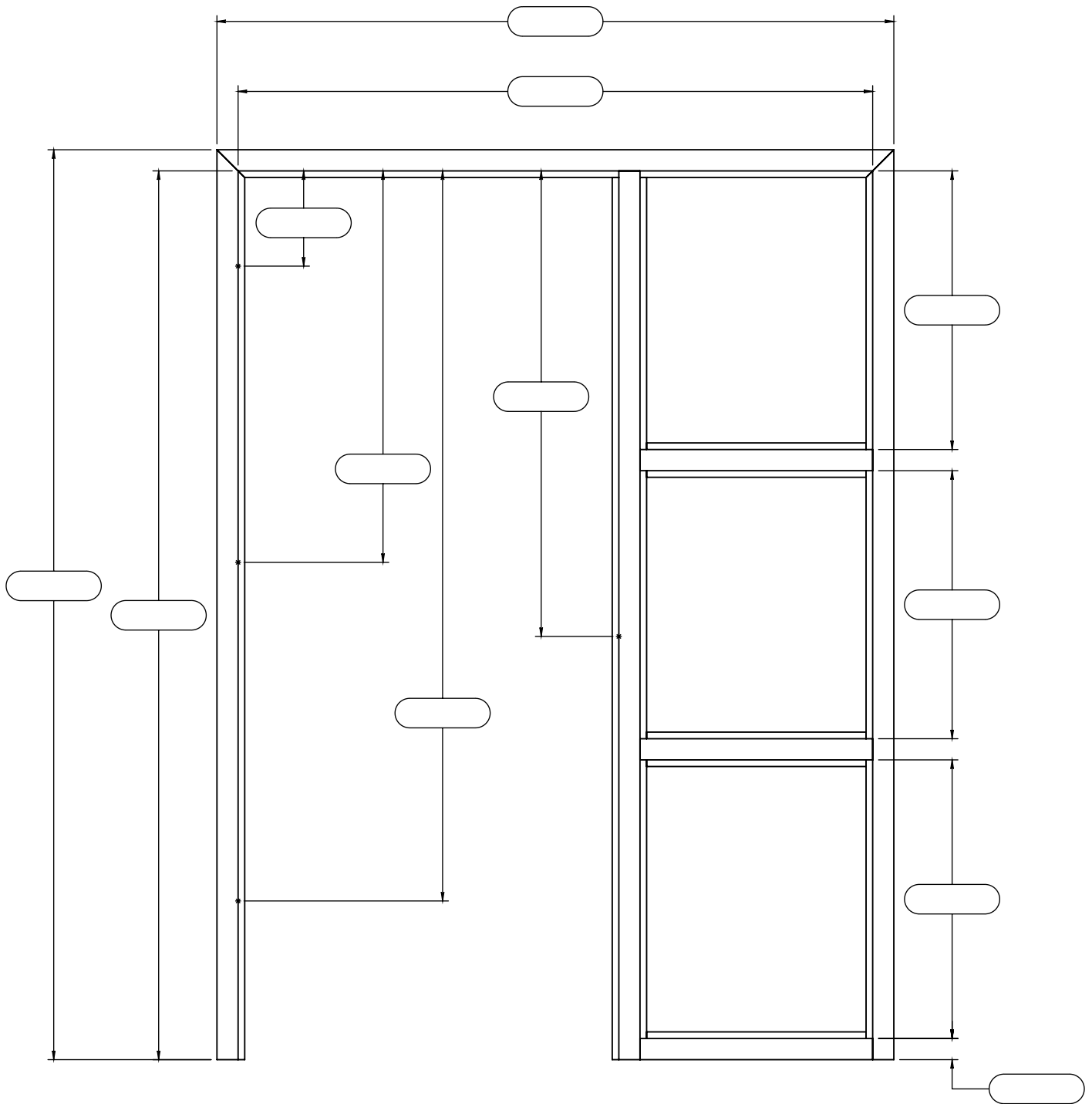

Material:	Handing:	Jamb Depth:	Locations:
Fire Label:	Construction	Mark #:	Notes:

SINGLE SIDELITE 3 HM

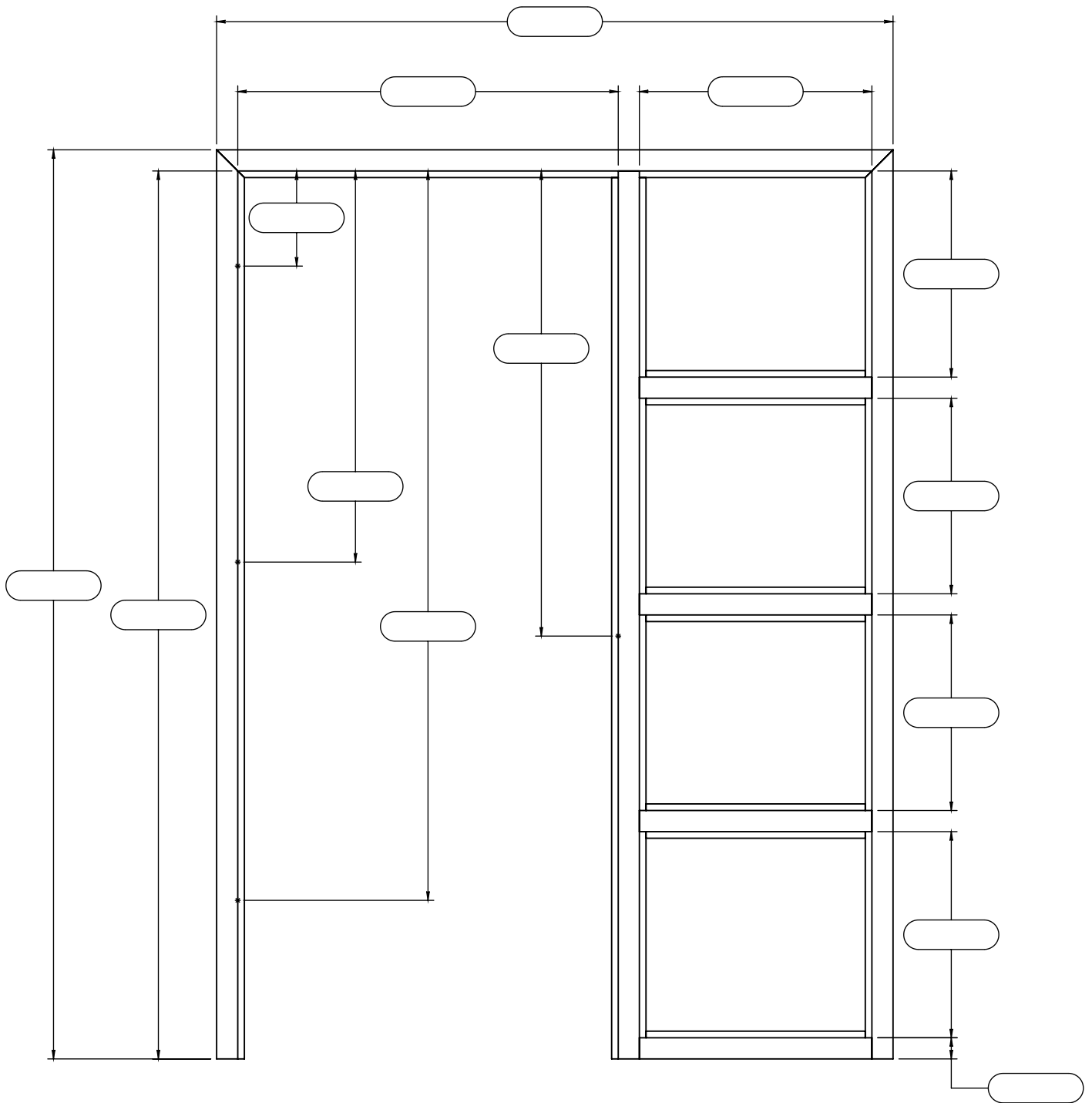

Material:	Handing:	Jamb Depth:	Locations:
Fire Label:	Construction	Mark #:	Notes:

SINGLE SIDELITE 1 VM

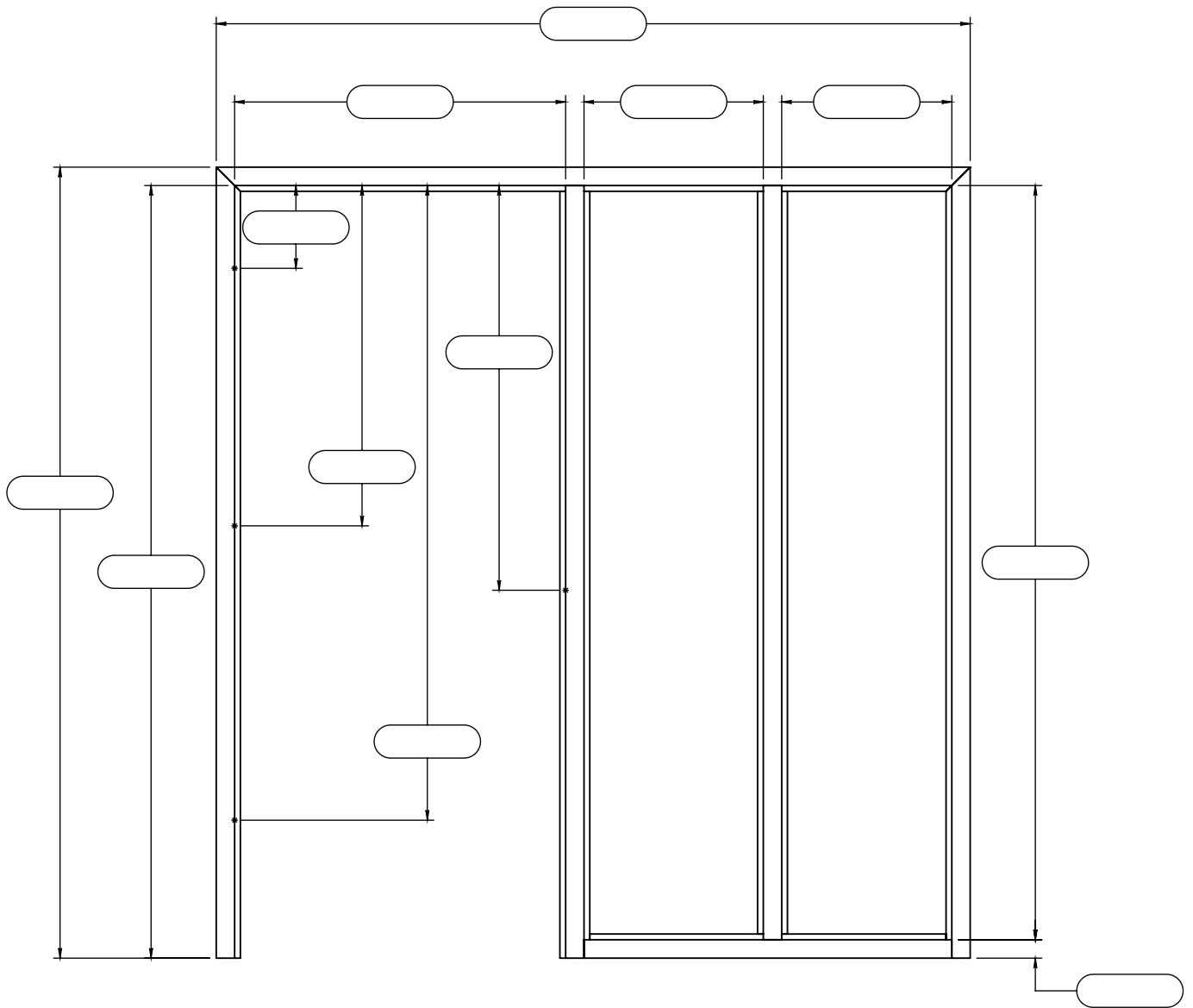

Material:	Handing:	Jamb Depth:	Locations:
Fire Label:	Construction	Mark #:	Notes:

SINGLE SIDELITE 2 VM

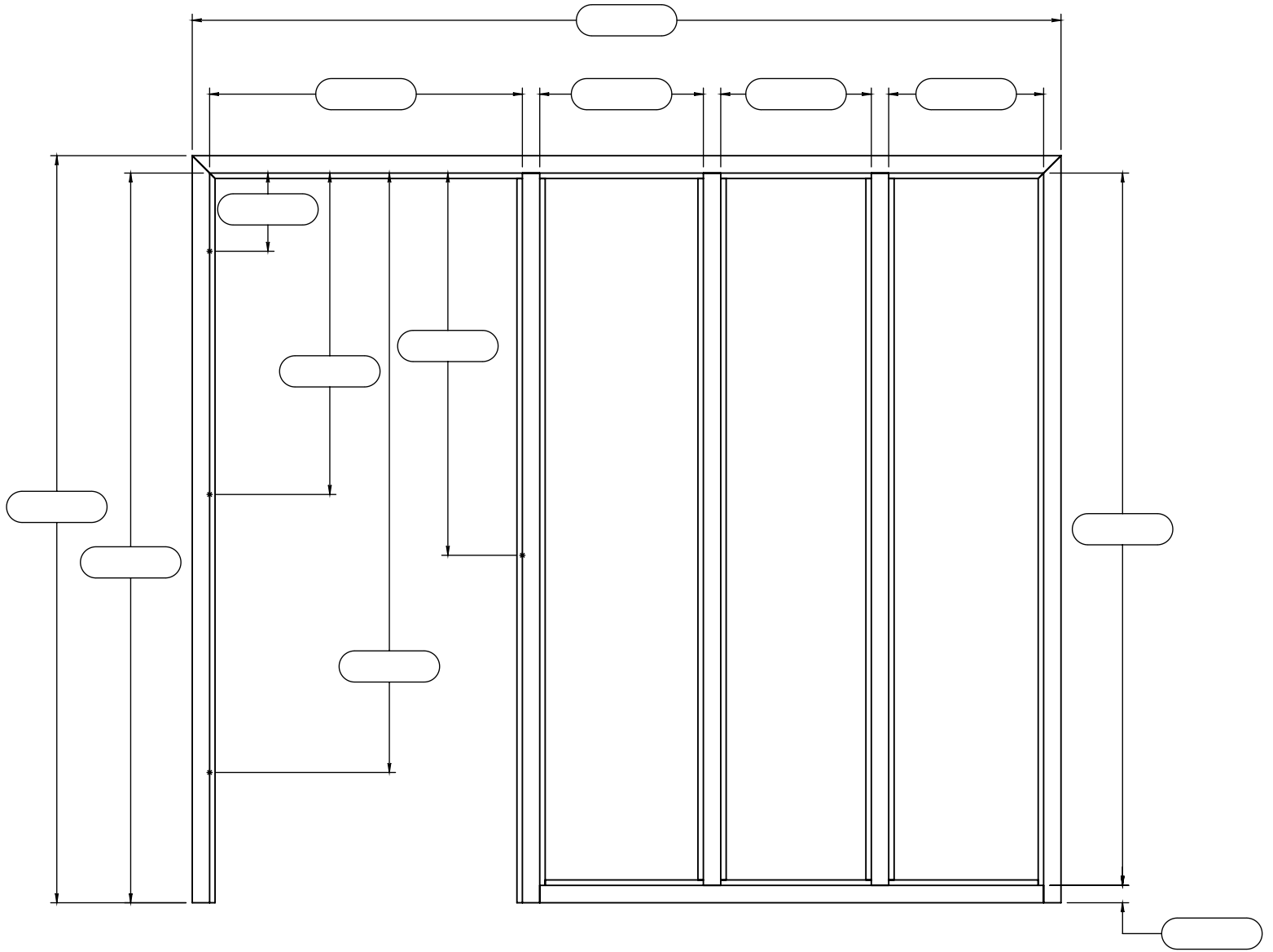

Material:	Handing:	Jamb Depth:	Locations:
Fire Label:	Construction	Mark #:	Notes:

SINGLE SIDELITE 1HM X 1 VM

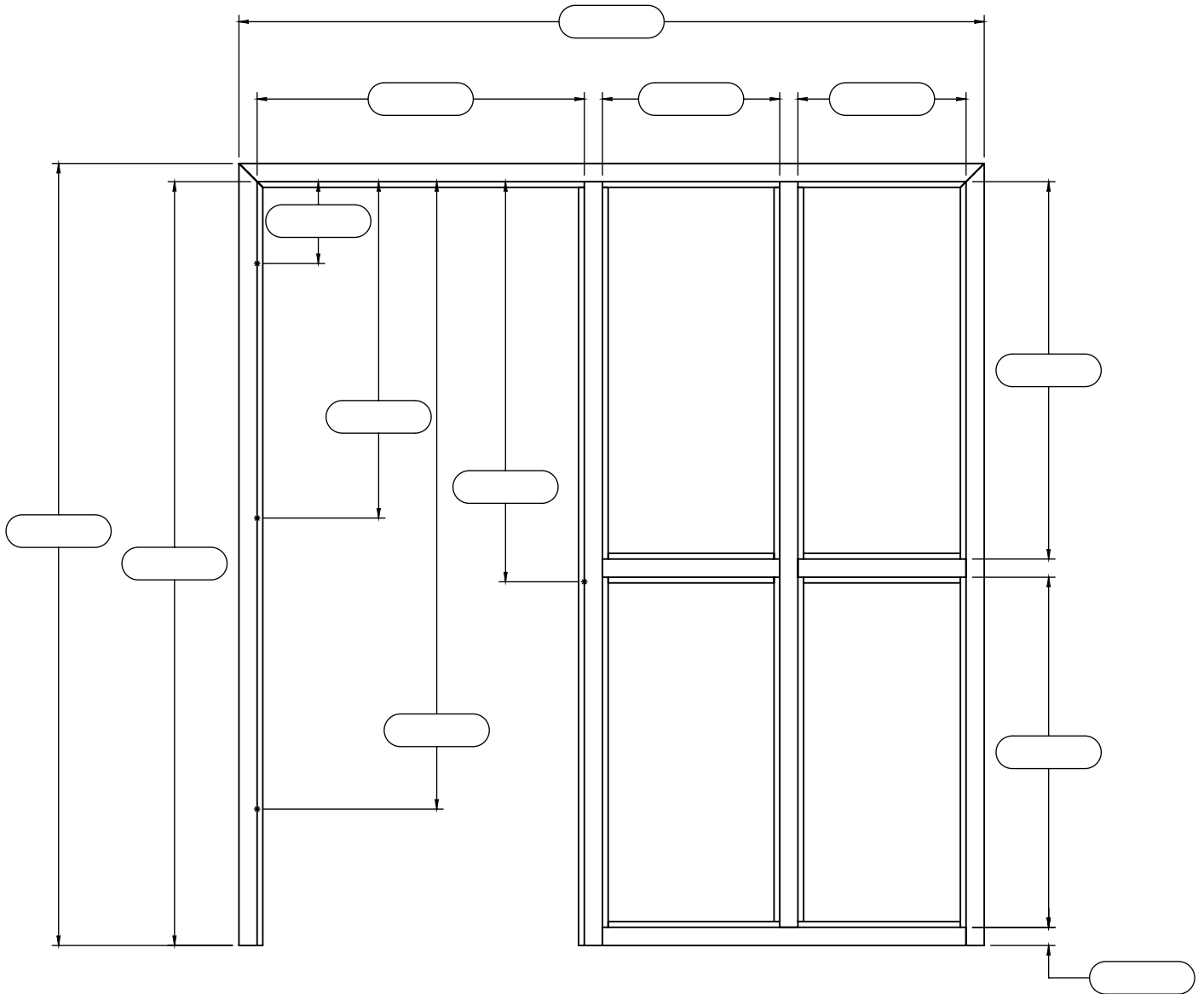

Material:	Handing:	Jamb Depth:	Locations:
Fire Label:	Construction	Mark #:	Notes:

SINGLE SIDELITE 1 HM X 2 VM

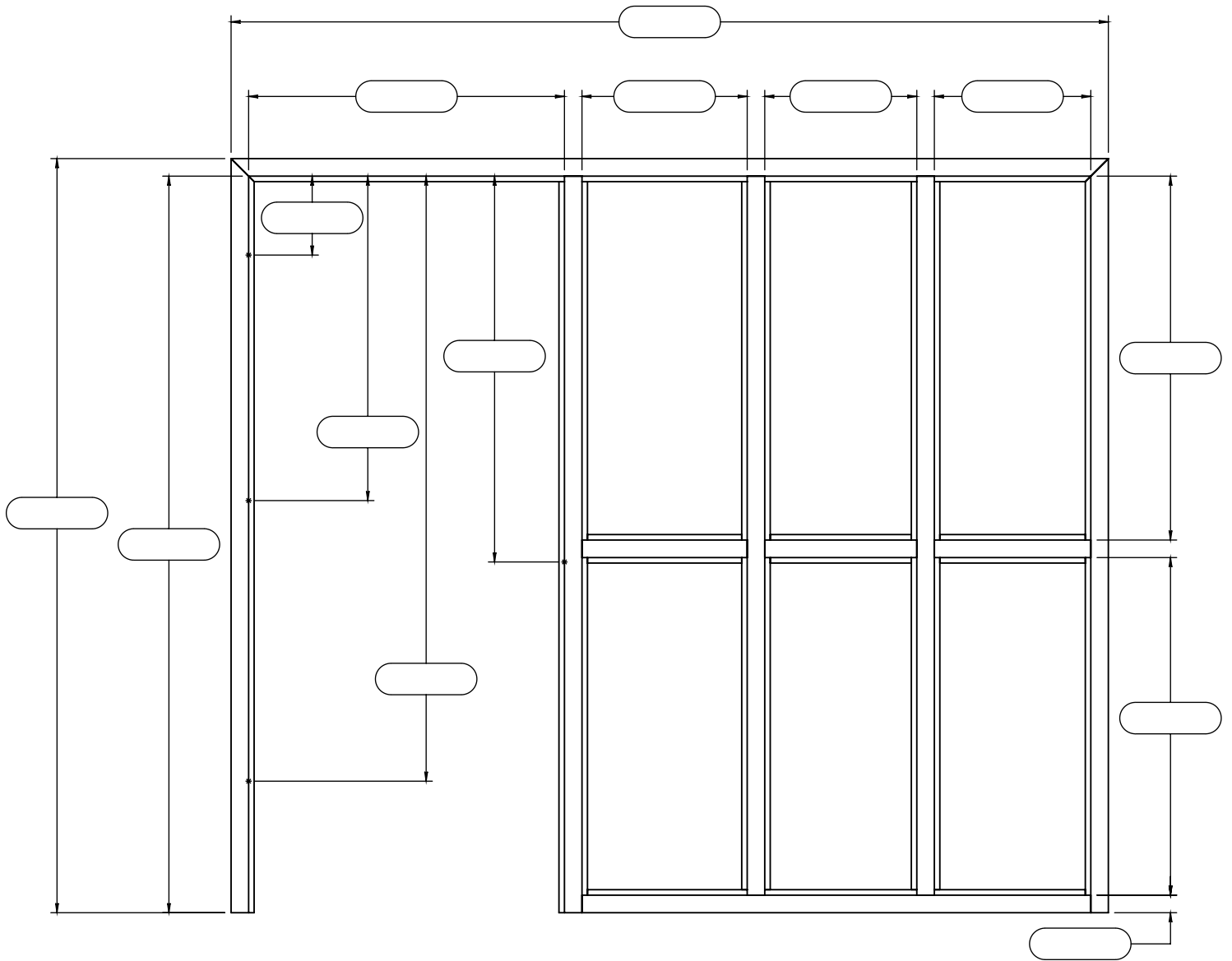

Material:	Handing:	Jamb Depth:	Locations:
Fire Label:	Construction	Mark #:	Notes:

DOUBLE SIDELITE

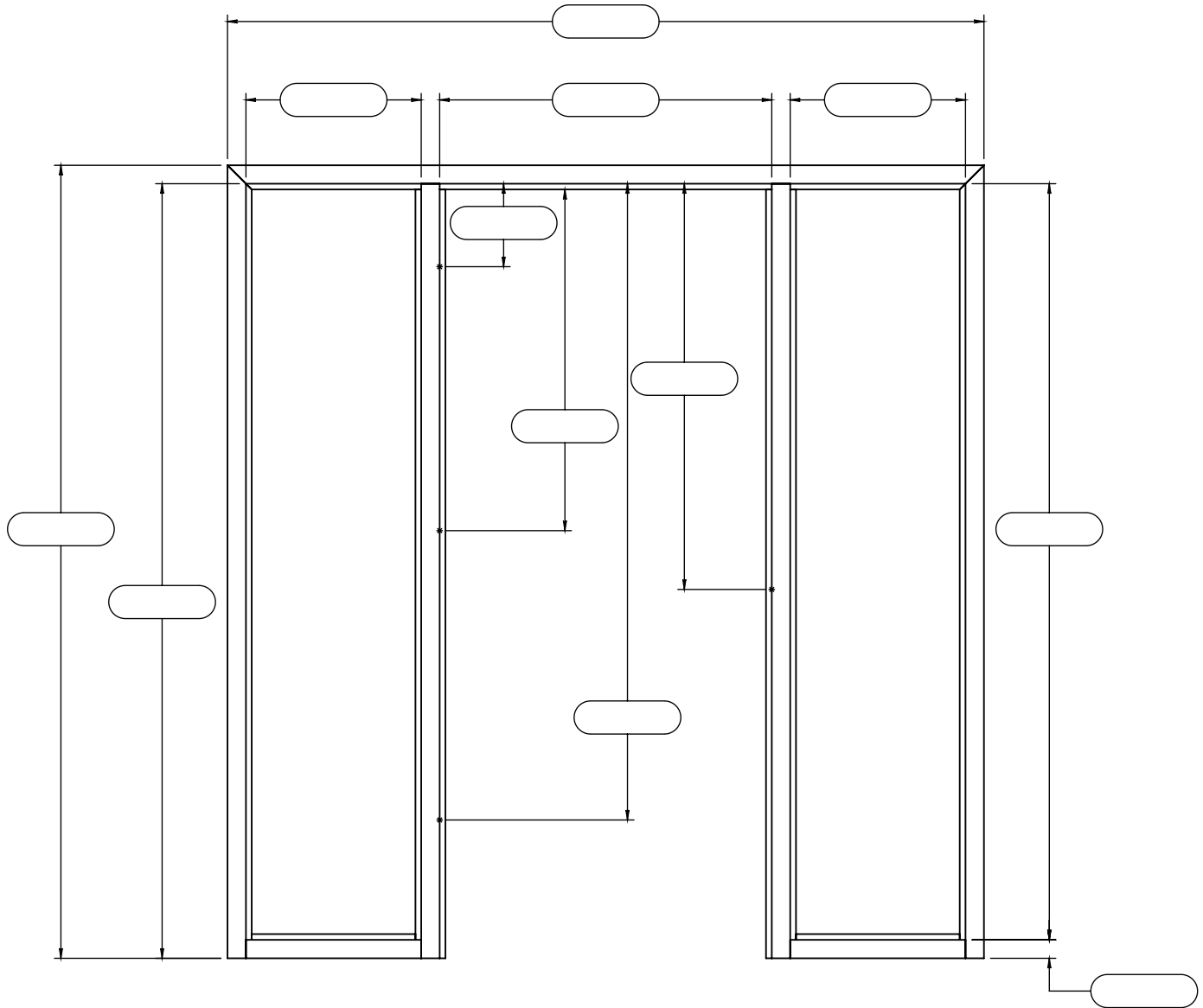

Material:	Handing:	Jamb Depth:	Locations:
Fire Label:	Construction	Mark #:	Notes:

DOUBLE SIDELITE 1 HM

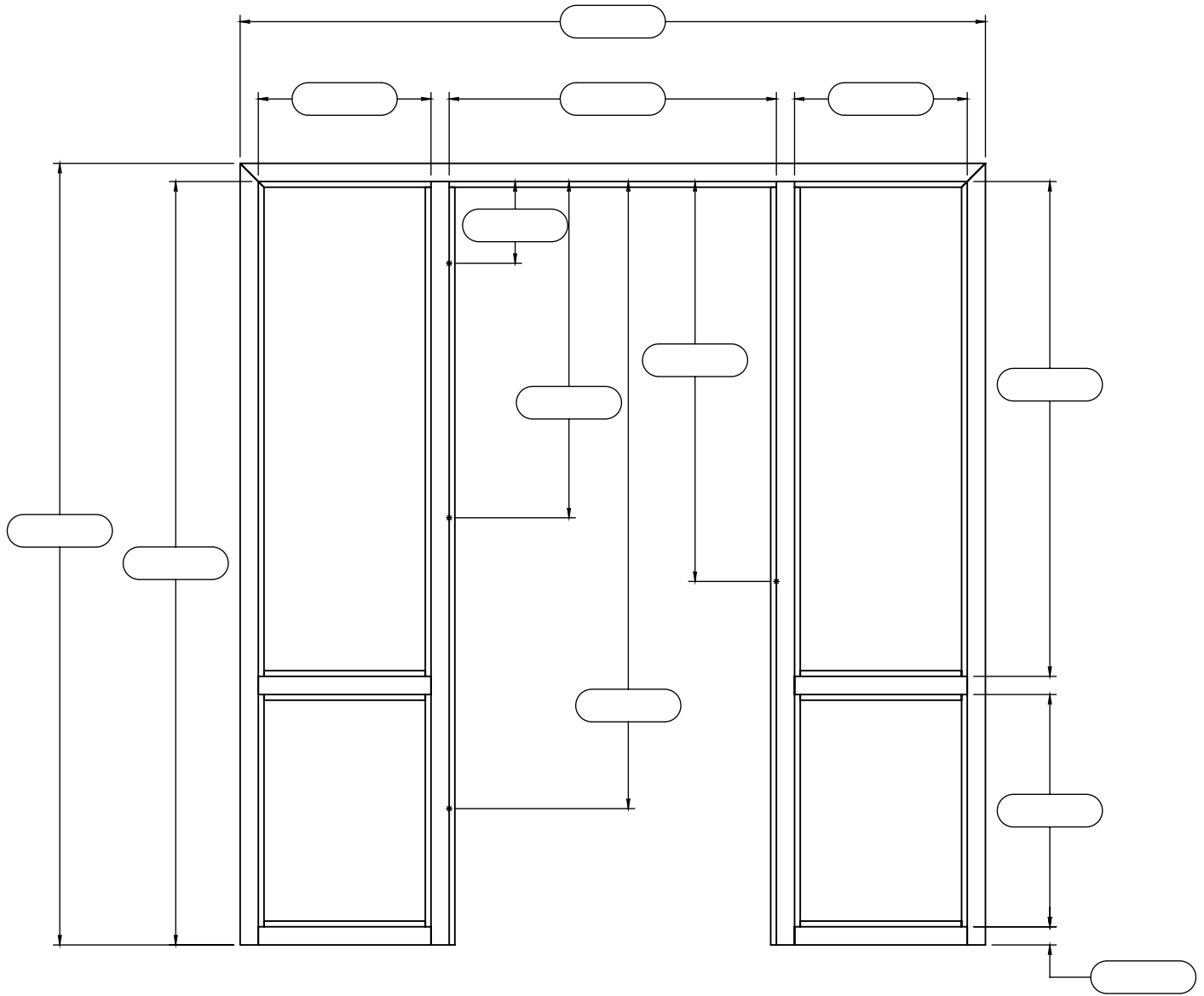

Material:	Handing:	Jamb Depth:	Locations:
Fire Label:	Construction	Mark #:	Notes:

DOUBLE SIDELITE 2 HM

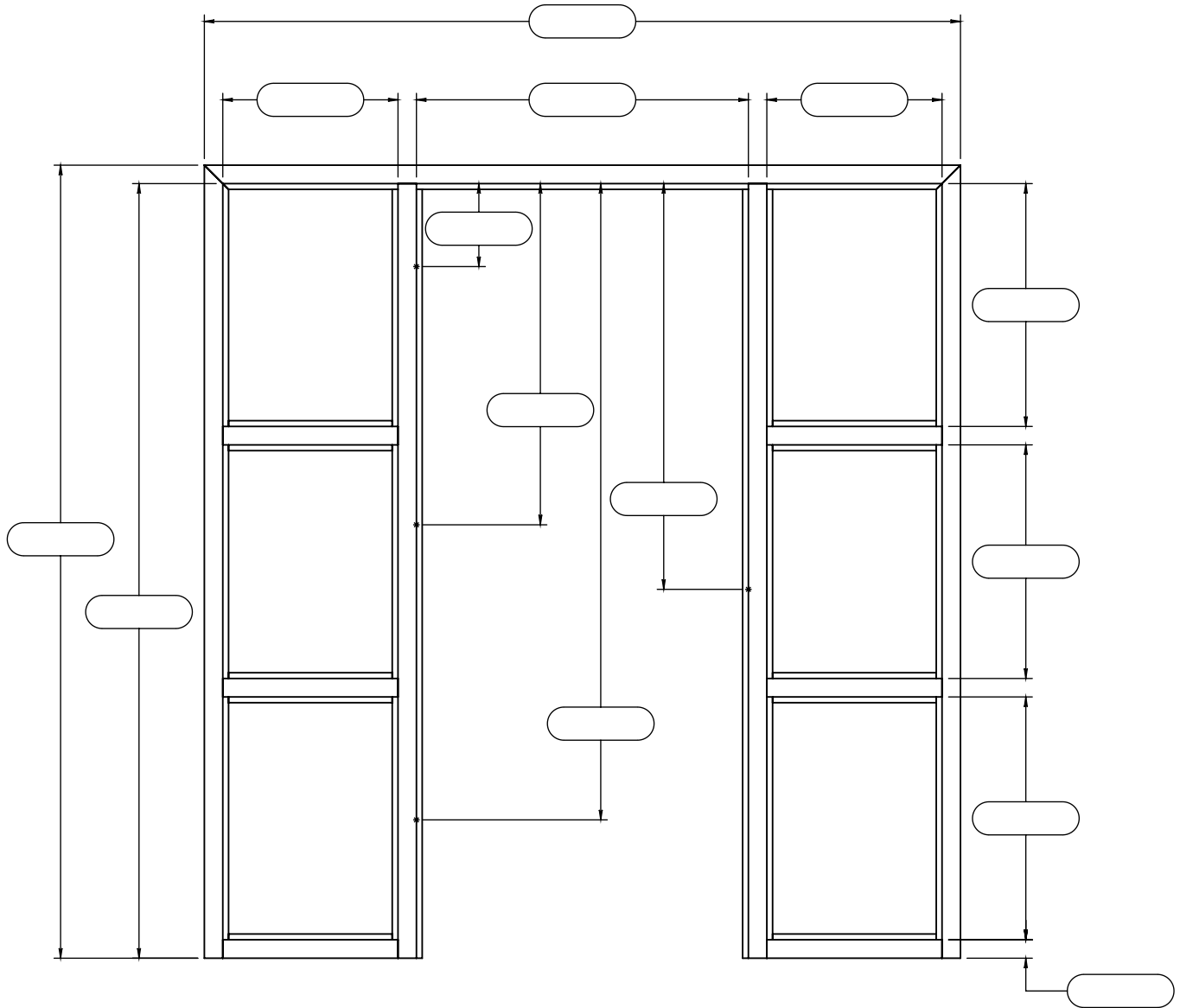

Material:	Handing:	Jamb Depth:	Locations:
Fire Label:	Construction	Mark #:	Notes:

DOUBLE SIDELITE 3 HM

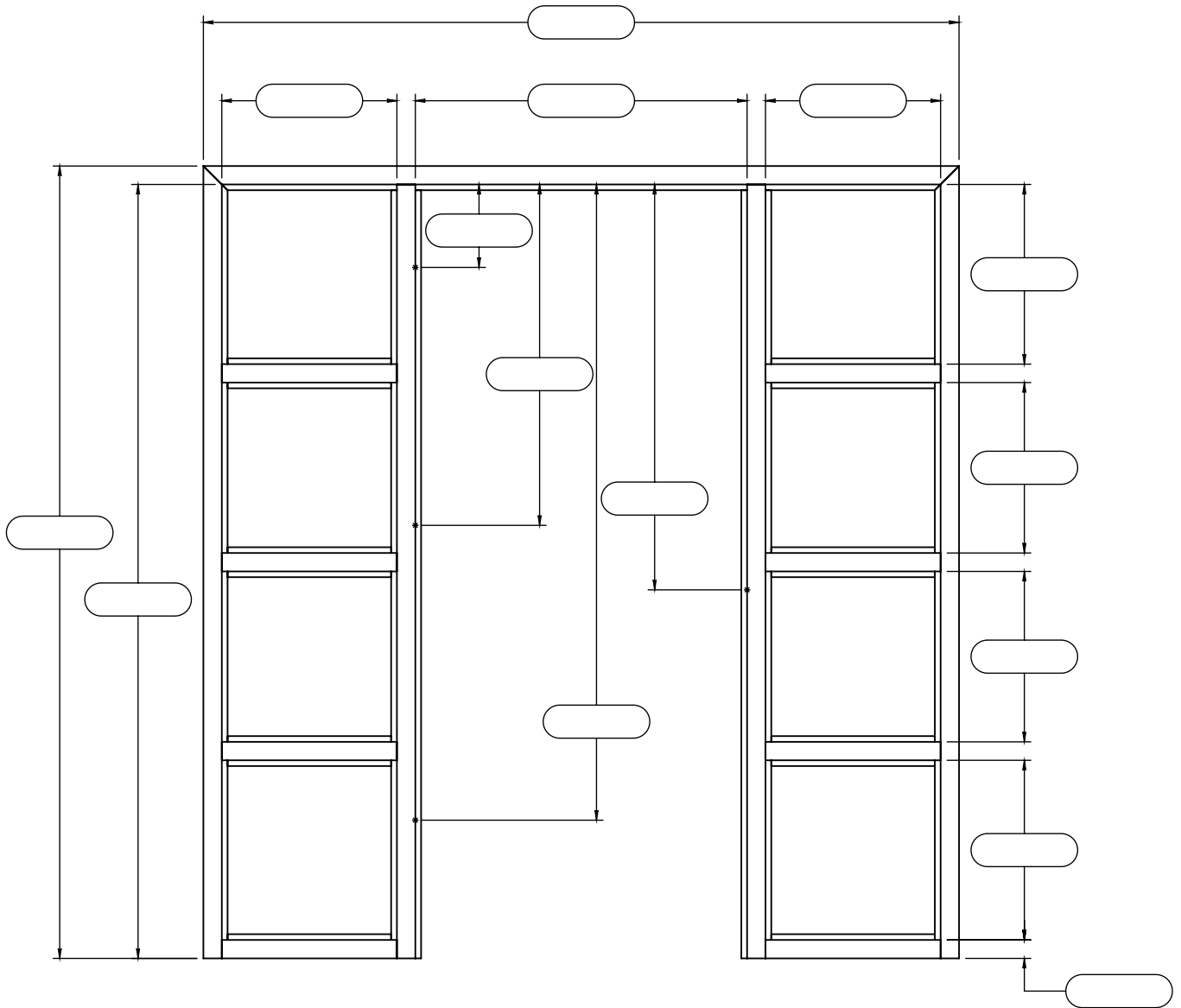

Material:	Handing:	Jamb Depth:	Locations:
Fire Label:	Construction	Mark #:	Notes:

PARTIAL SINGLE SIDELITE

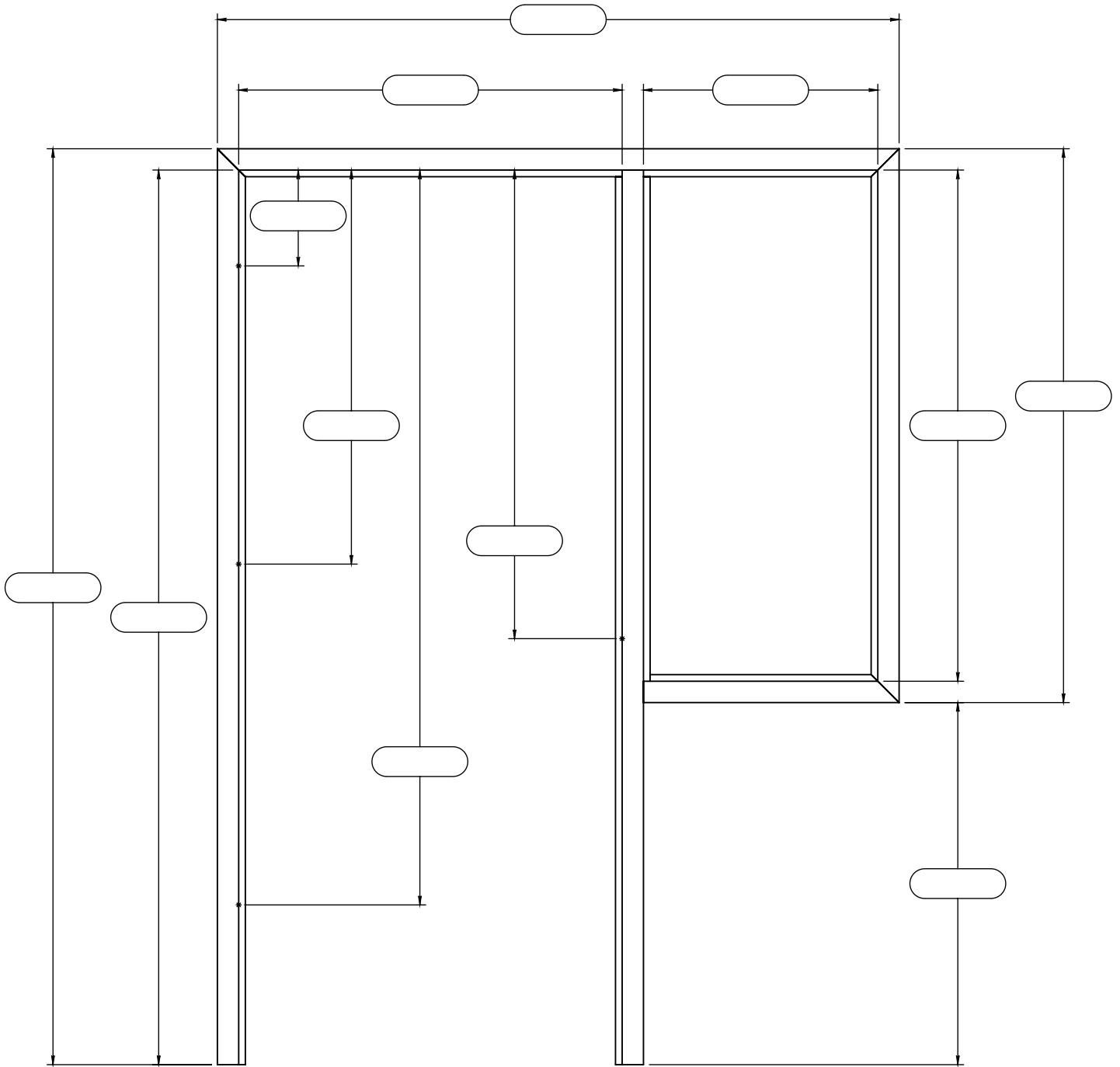

Material:	Handing:	Jamb Depth:	Locations:
Fire Label:	Construction	Mark #:	Notes:

PARTIAL DOUBLE SIDELITE

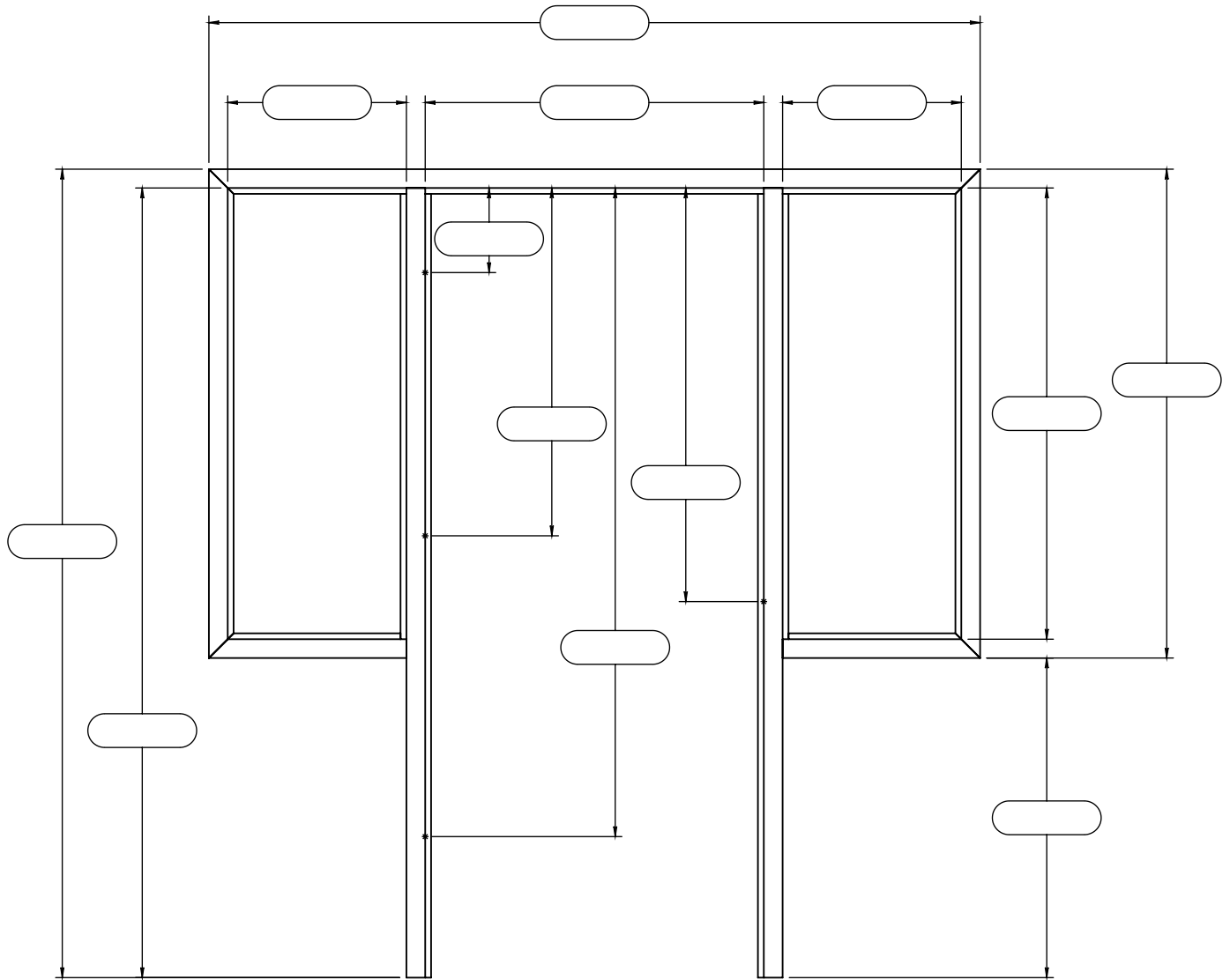

Material:	Handing:	Jamb Depth:	Locations:
Fire Label:	Construction	Mark #:	Notes:

TRANSOM SINGLE SIDELITE

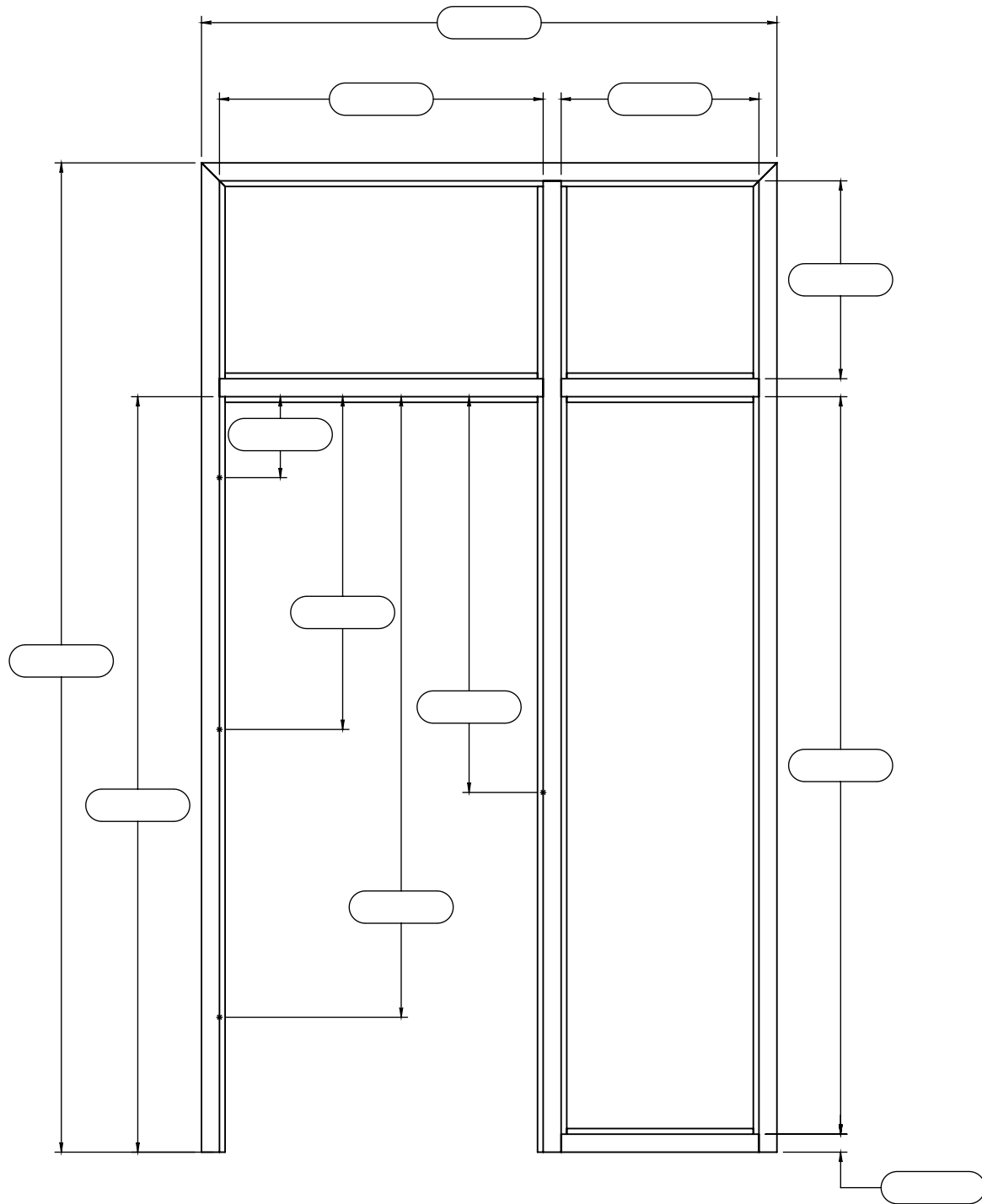

Material:	Handing:	Jamb Depth:	Locations:
Fire Label:	Construction	Mark #:	Notes:

TRANSOM SINGLE SIDELITE OPEN

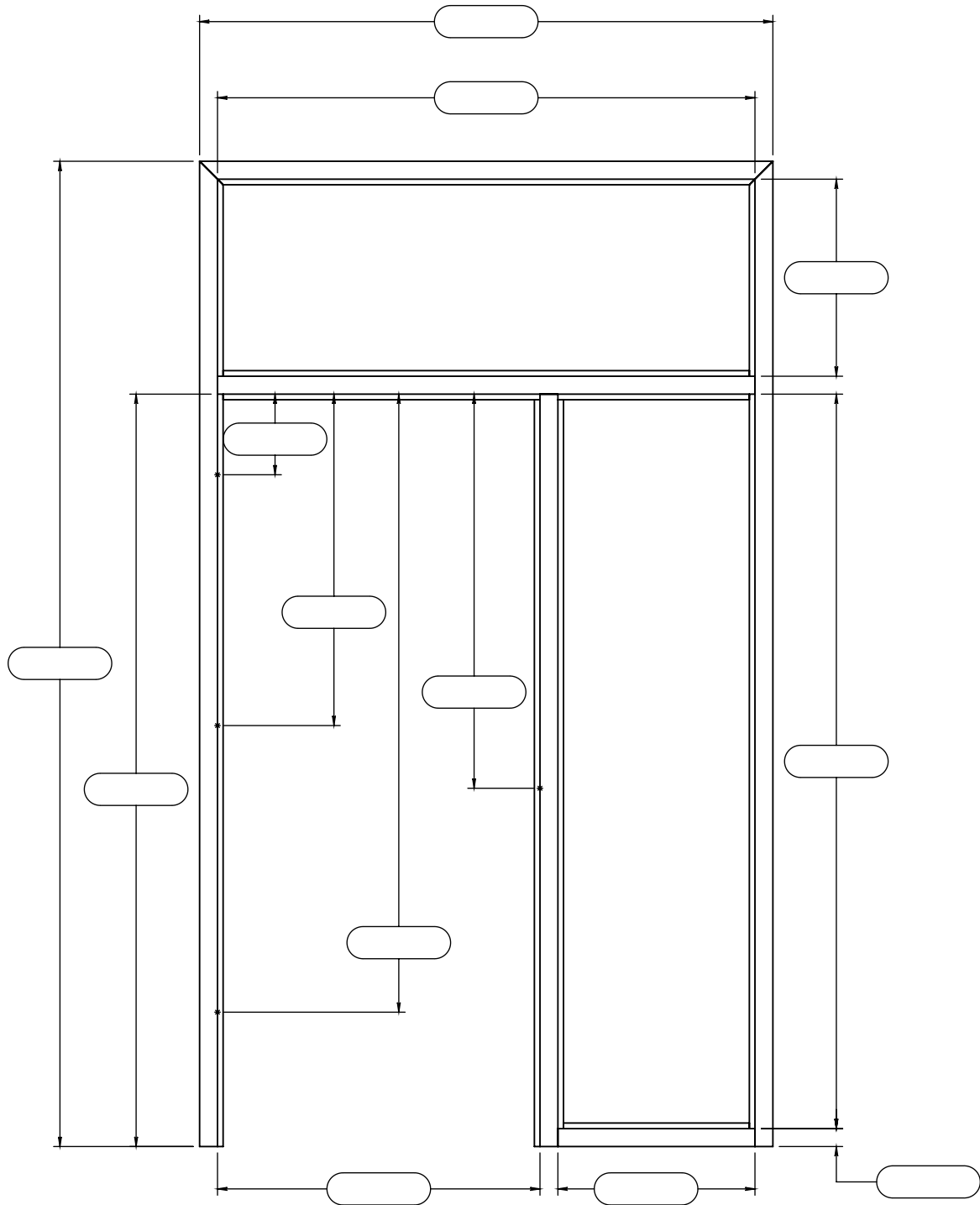

Material:	Handing:	Jamb Depth:	Locations:
Fire Label:	Construction	Mark #:	Notes:

TRANSOM DOUBLE SIDELITE

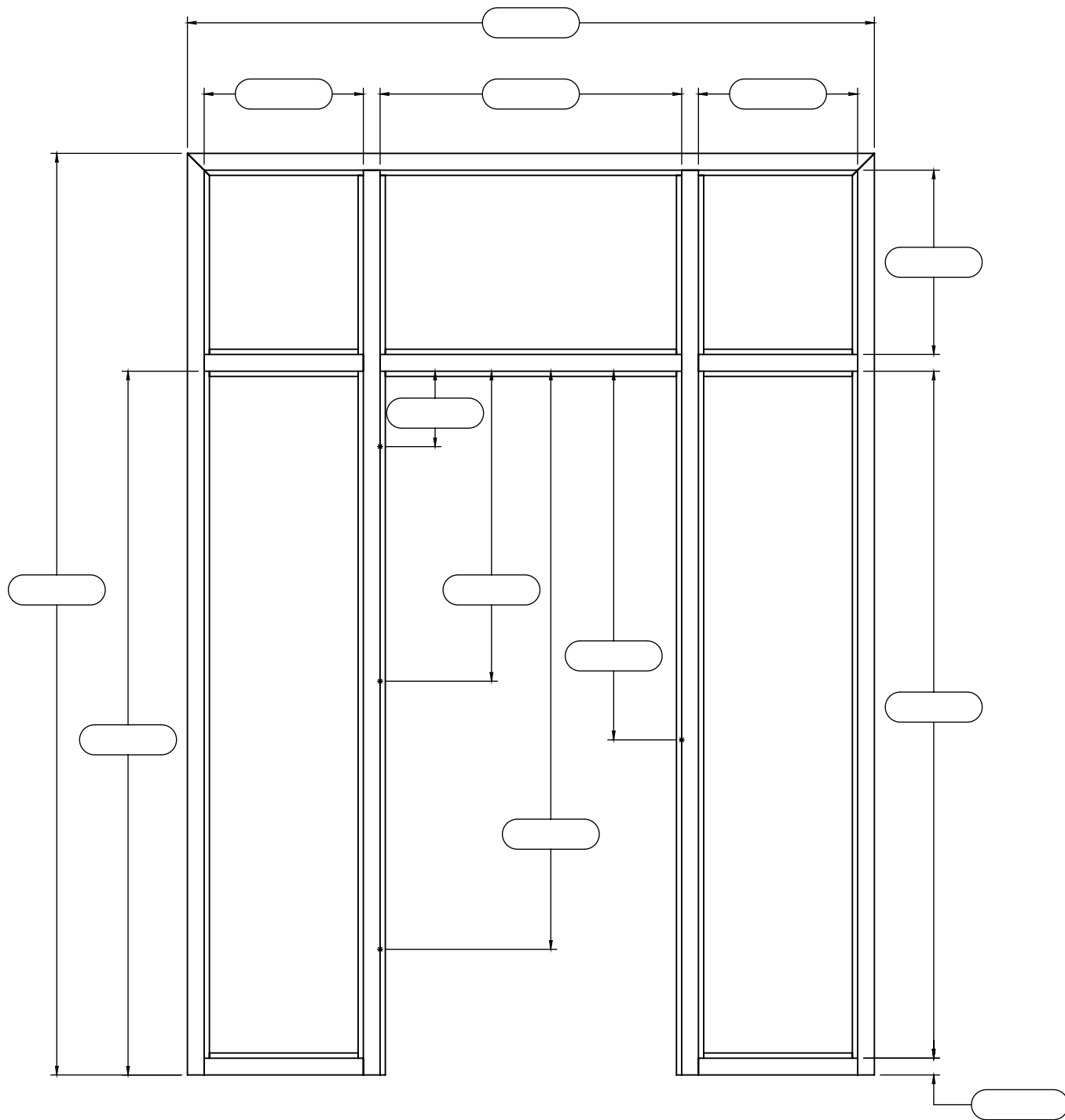

Material:	Handing:	Jamb Depth:	Locations:
Fire Label:	Construction	Mark #:	Notes:

TRANSOM DOUBLE SIDELITE OPEN

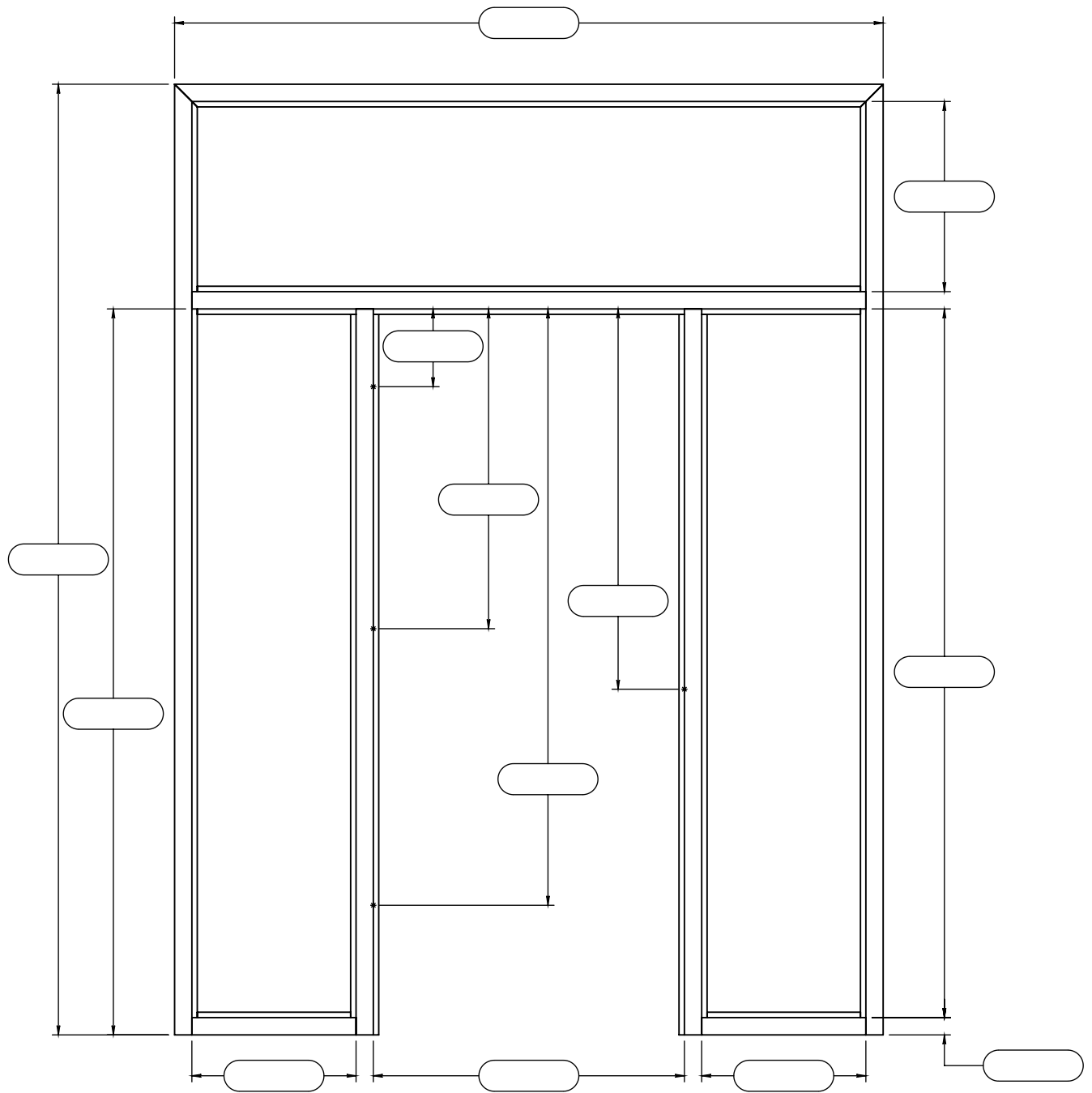

Material:	Handing:	Jamb Depth:	Locations:
Fire Label:	Construction	Mark #:	Notes: