

Ideal for monitoring opacity and smoke levels in the exhaust gas of industrial combustion or air filtration processes.



- **In-situ measurement directly in exhaust gas flow using the widely accepted light transmission technique**
- **Measurement reading as % opacity**
- **Modulated green LED source for long lifetime stability and immunity to ambient light**
- **Rugged 316L stainless steel construction**
- **Choice of interface options enabling easy integration**
- **Free utility software for PC based setup, control, and data logging**

The DSL-320 is an optical instrument designed to measure the visible opacity (0-100%) of exhaust gas in a duct, stack, or flue; typically the exhaust gas from an industrial combustion process or air filtration system.

The DSL-320 uses the double pass light transmission measurement technique, with a folded beam Transceiver /Reflector arrangement. A light beam emitted from the Transceiver (TRX) passes across the duct, stack or flue to a Reflector, which then returns the light to the Transceiver where the intensity of the received light is measured. Increased particulate or dust in the stack gas attenuates the transmitted light and causes the intensity of the received light to fall. This reduction in intensity is measured and presented as % opacity.

The light source in the Transceiver is a high intensity, high reliability green LED which provides long life and stable intensity. The transmitted light beam is pulsed to give complete immunity to ambient light levels. The intensity of the transmitted light is monitored at source so that any variations in the emitted light level are compensated in the received signal. The Transceiver has on board temperature measurement to provide stability over temperature range.

The DSL-320 is available with or without an Operator Interface (control unit) so for the most cost effective monitoring solution the DSL-320 can operate as a “stand-alone” instrument consisting of the Transceiver head (TRX) and Reflector head, with all electrical connections (including outputs such as the alarm relays, 4-20mA and ModBus) being made inside the TRX head. As a stand-alone instrument the DSL-320 is set-up and controlled using the supplied utility software, installed on a PC or laptop, and connected via the USB connector on the TRX.

When supplied with an Operator Interface (OI) all power supply and output connections are made in the OI rather than the RX. The OI is available in a range of enclosure styles, it has a bright 4 digit LED display and a simple 4 button keypad, which allows full command and control of the instrument. Alternatively, the free utility software can be connected to the OI and used to command and control the DSL-320 directly from a PC.

The DSL-320 has no moving parts, is of rugged design and has an excellent reliability record. Regular maintenance simply involves cleaning the optical surfaces which are easily accessible due to our latched head design. Both the TRX and Reflector heads are supplied with an air purge body, which when connected to a high volume source of clean air, keeps the contaminated stack gas away from the lens surfaces. An Aluminium air purge body is available for use on standard installations and a more advanced Stainless Steel air purge body is available for more demanding installations.

Specification:

Measurement Performance

No.	Parameter	Units	Min	Max	Comment
1	Path Length (flange to flange)	m	0.5	10	Flange-to-flange separation
2	Measuring Range	%	0.0	100.0	User selectable
3	Accuracy	%	-2	+2	
4	Resolution	%		0.1	Display resolution
5	Damping	s	1	60	Selectable
6	Drift with Temperature	%	-2	+2	Over any 20°C in the operating range
7	Operating Wavelength	nm	510	540	Green LED

Power & Air Requirements

8	Voltage	Vdc	+24		Optional 90-260Vac PSU available
9	Voltage Tolerance	%	-10	+10	
10	Nominal Current Consumption	mA		500	
11	Power Up Current Consumption	mA		500	
12	Air Supply Volume Flow	L/min	50	200	To each air-purge body.
13	Air Supply Fitting		1" BSP threaded aperture in each air-purge body		

Cable and Wire

14	Cable type - OI/TRX Interconnection	cores	4		Screened multi-core, such as Belden 9873
15	Wire Size at Terminal Connections	AWG	20	14	

Interface Options

16	Serial Comms				ModBus RTU via RS485 (TRX) Internal USB (OI), external USB (TRX)
17	Analogue Output (one)	mA	4	20	Isolated and scalable
18	Digital Relay Contacts (two)	A	0	3	@30Vdc (signal level and data valid)

Physical

19	Ingress Protection: - Heads		IP65		For external use
20	Ingress Protection: - OI Wall Mounted - OI Panel Mounted		IP65 IP64		Hinged door and terminal compartment shut. From front face of panel when installed.
21	Ambient Operating Temperature	°C	-20	+55	Air temperature around the heads.
22	Operating Humidity	%		100	Air humidity around the heads.
23	Gas Temperature	°C		+600	Heat insulating gaskets included. (Higher temperatures on request)
24	Regulatory Compliance				2014/30/EU (Electromagnetic Radiation) 2014/35/EU (Low Voltage)
25	Materials: - Heads	AISI/SAE 316L stainless steel			
26	Materials: - Air-Purge Bodies	Powder coated cast aluminium or stainless steel for demanding installations			
27	Materials: - OI Wall Mounted	UL rated polycarbonate enclosure; aluminium front panel with PU laminate overlay and with nylon cable glands			
	- OI Panel Mounted	Powder coated steel back-box; aluminium front panel with PU laminate overlay and with nylon cable glands			
28	Weight	kg		2.5	TRX or Reflector head plus Aluminium Air-Purge body
29	Weight: - OI Wall Mounted	kg		1.3	
	- OI Panel Mounted			1.3	
30	Warranty	months	24		Return to base warranty. Extensions available

Configuration Options:

Configured with an OI: Wall or Panel Mounting

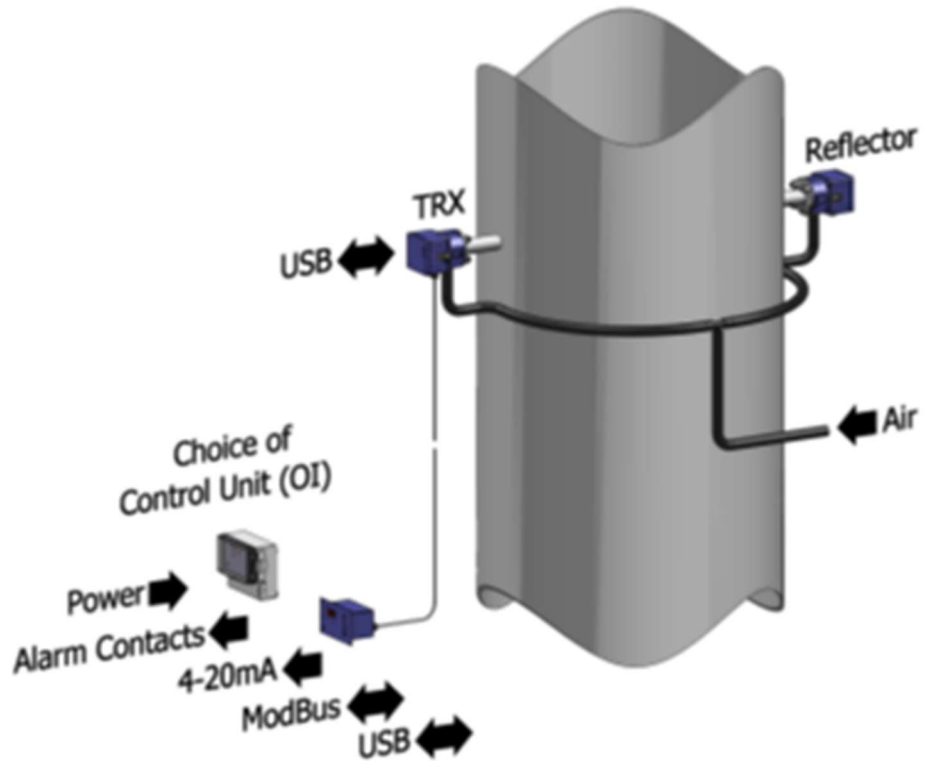



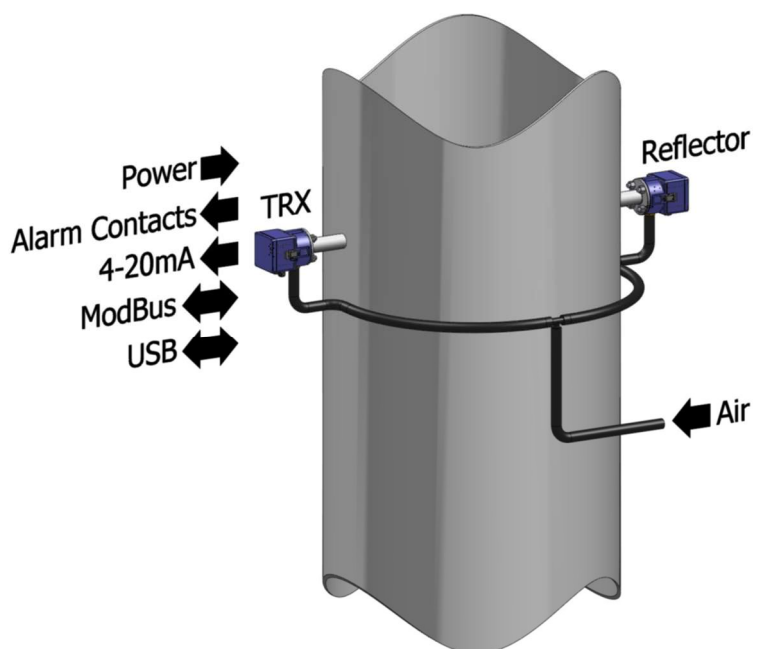

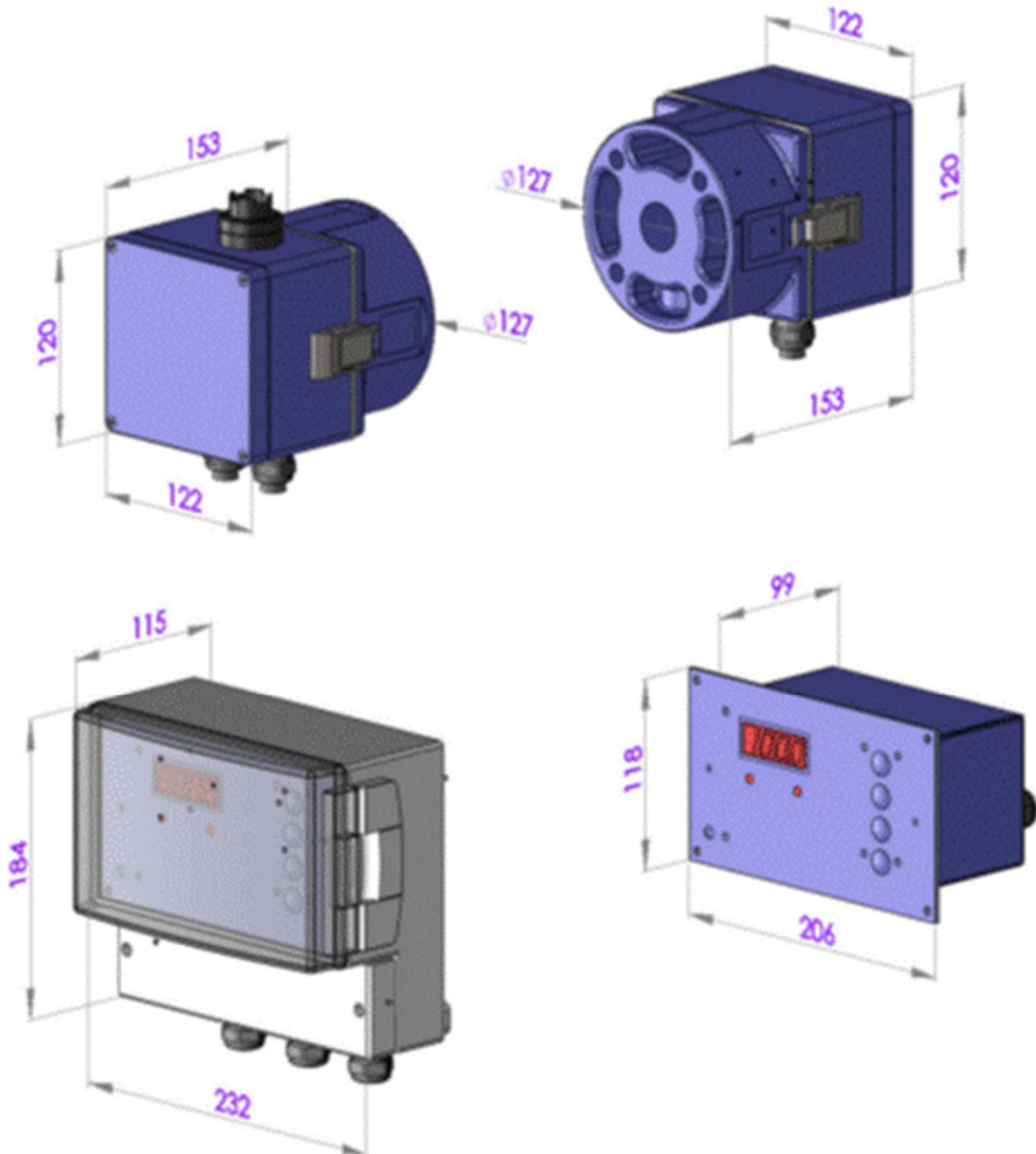
Stand Alone Configuration

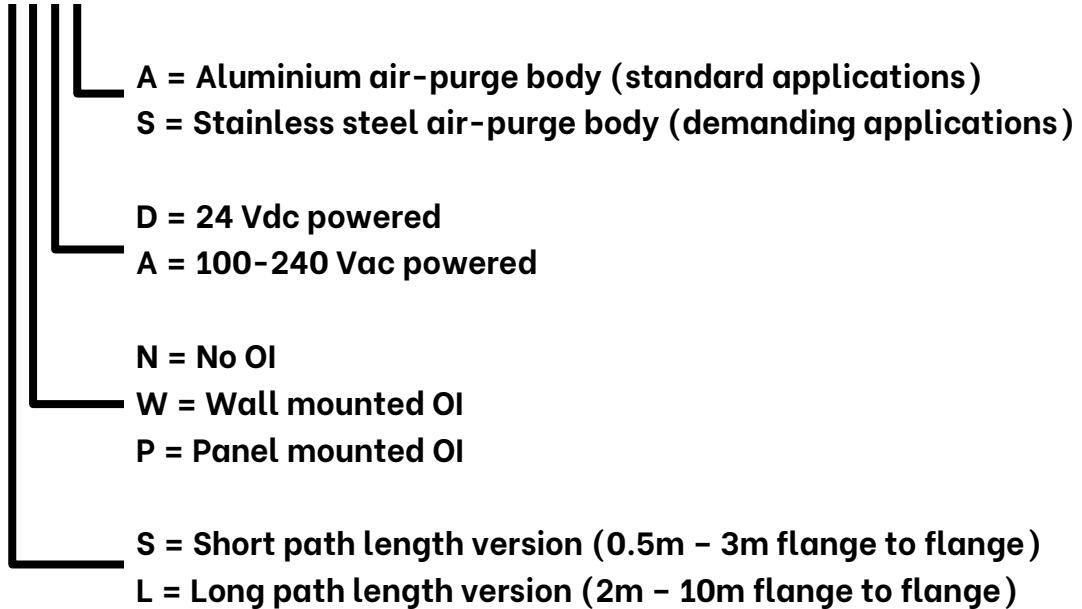





Dimensions (mm):

Ordering Details:**DSL-320-XXXX-MKIII**

Options & Accessories:

Description	Order Code	Notes
	ASY-067	1.5" ANSI 150 flange pattern with 240mm long extension tube (x2).
Fixing Kit for use with Aluminium Air Purge Body	ASY-071	Contains M14 x 100mm studding, flat washers, spring washers and M14 nuts.
Fixing Kit for use with Stainless Steel Air Purge Body	ASY-245	Contains M14 x 100mm studding, flat washers, spring washers and M14 nuts.
	ASY-080	Hinged stainless steel weather / heat cover for protecting externally mounted heads.
Screened Cable	CBL-099	7-core, screened, LSZH cable.
Boxed PSU	DSL-PSU-25	Multi AC input, 24Vdc output 25W, IP67 rated enclosure
	DSL-LAT08A	Tool to aid the alignment of the two heads across the stack.
	DSL-BK40B-110	Blower kit for purge air. 110 Vac; single phase
	DSL-BK40B-230	Blower kit for purge air. 230 Vac; single phase
	DSL-BK40B-415	Blower kit for purge air. 415 Vac; three phase

<p>Compressed Air Kit</p> 	<p>DSL-CAK-2</p>	<p>For use with compressed air purge.</p> <p>Includes pressure regulator, in-line filters, and compressed air adaptors for the purge body.</p>
<p>Calibration Head</p> 	<p>DSL-CH350BA</p>	<p>For use between the TRX head and the purge body to perform calibration checking with aluminium type air-purge bodies. (Calibration head only, no filters or Zero Mirror included).</p>
	<p>DSL-CH350BS</p>	<p>For use between the TRX head and the purge body to perform calibration checking with stainless steel type air-purge bodies. (Calibration head only, no filters or Zero Mirror included).</p>
<p>Zero Mirror for Calibration Checking</p> 	<p>ASY-292</p>	<p>DSL-320S: path lengths 0.5m to 1.5m DSL-320L: path lengths 2.0m to 4.0m</p>
	<p>ASY-287</p>	<p>DSL-320S: path lengths 1.5m to 4.0m DSL-320L: path lengths 4.0m to 8.0m</p>
	<p>ASY-293</p>	<p>DSL-320L: path lengths 8.0m to 10.0m</p>
<p>Calibrated Opacity Filters</p>  <p>(other values available on request)</p>	<p>ASY-190</p>	<p>Calibration filter, approx 8% opacity</p>
	<p>ASY-133</p>	<p>Calibration filter, approx 20% opacity</p>
	<p>ASY-183</p>	<p>Calibration filter, approx 35% opacity</p>

Note that the actual part may differ from the above representative pictures.