

PROJECT

PROJECT NUMBER:
PROPOSAL NUMBER:

REVISION HISTORY

REV#	DATE	DESCRIPTION
10		
9		
8		
7		
6		
5		
4		
3		
2		
1		
0	07.24.25	RELEASE FOR APPROVALS

SHEET INFORMATION

DRAWING TYPE: SHOP DRAWINGS
DRAWN BY: RAC
STANDARDS REVIEW: JBH
TECHNICAL REVIEW: JBH

THIS DOCUMENT CONTAINS PROPRIETARY INFORMATION OF 9WOOD, INC.
COPYRIGHT © 2024 9WOOD, INC.
ALL RIGHTS RESERVED.

KEY NOTES

- ① FURRING STRIP (TYP; BY SUBCONTRACTOR)
- ② WALL CONDITION (TYP; BY OTHERS)

SHEET TITLE

SYSTEM DETAILS

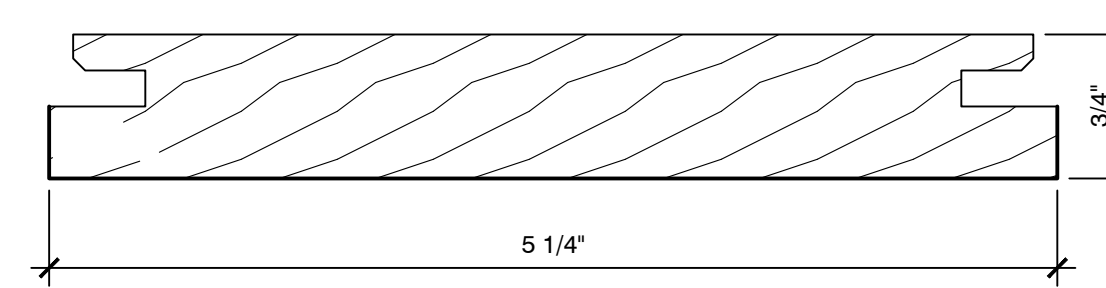

D4 SECTION - CONTINUOUS LINEAR OPEN REVEAL MEMBER
SCALE: 1" = 1"

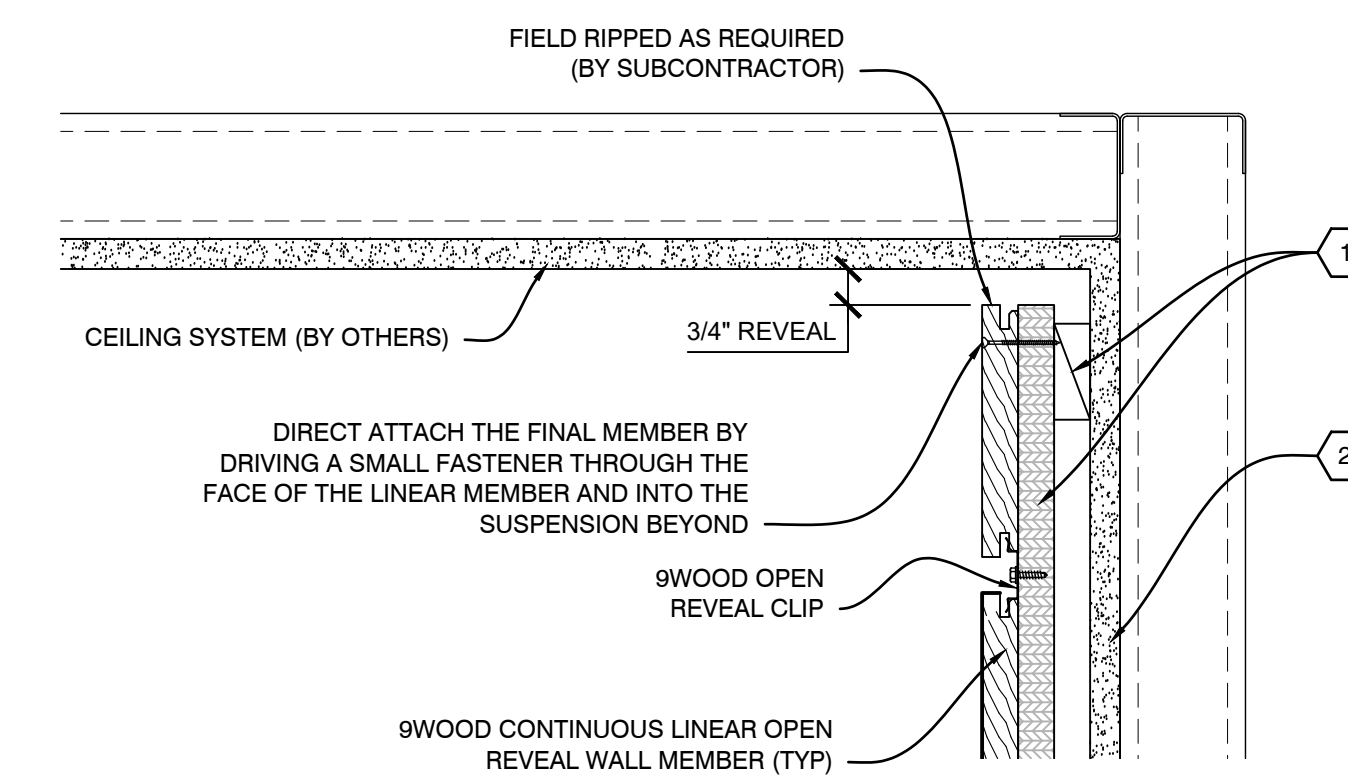

D4 SECTION - CEILING PERIMETER
SCALE: 1/4" = 1"

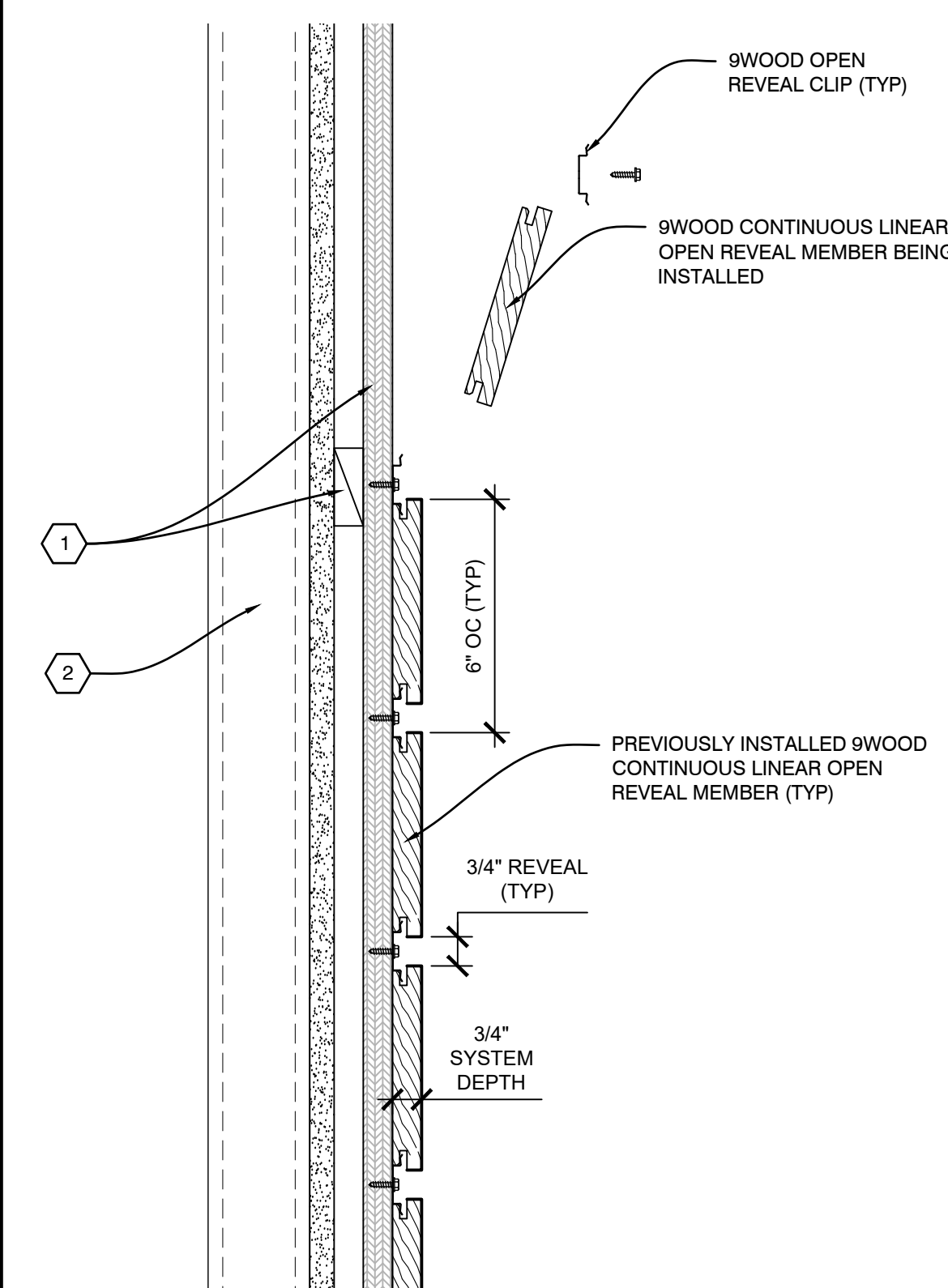

B3 INSTALLATION PROCESS - CONTINUOUS LINEAR OPEN REVEAL MEMBER
SCALE: 1/4" = 1"

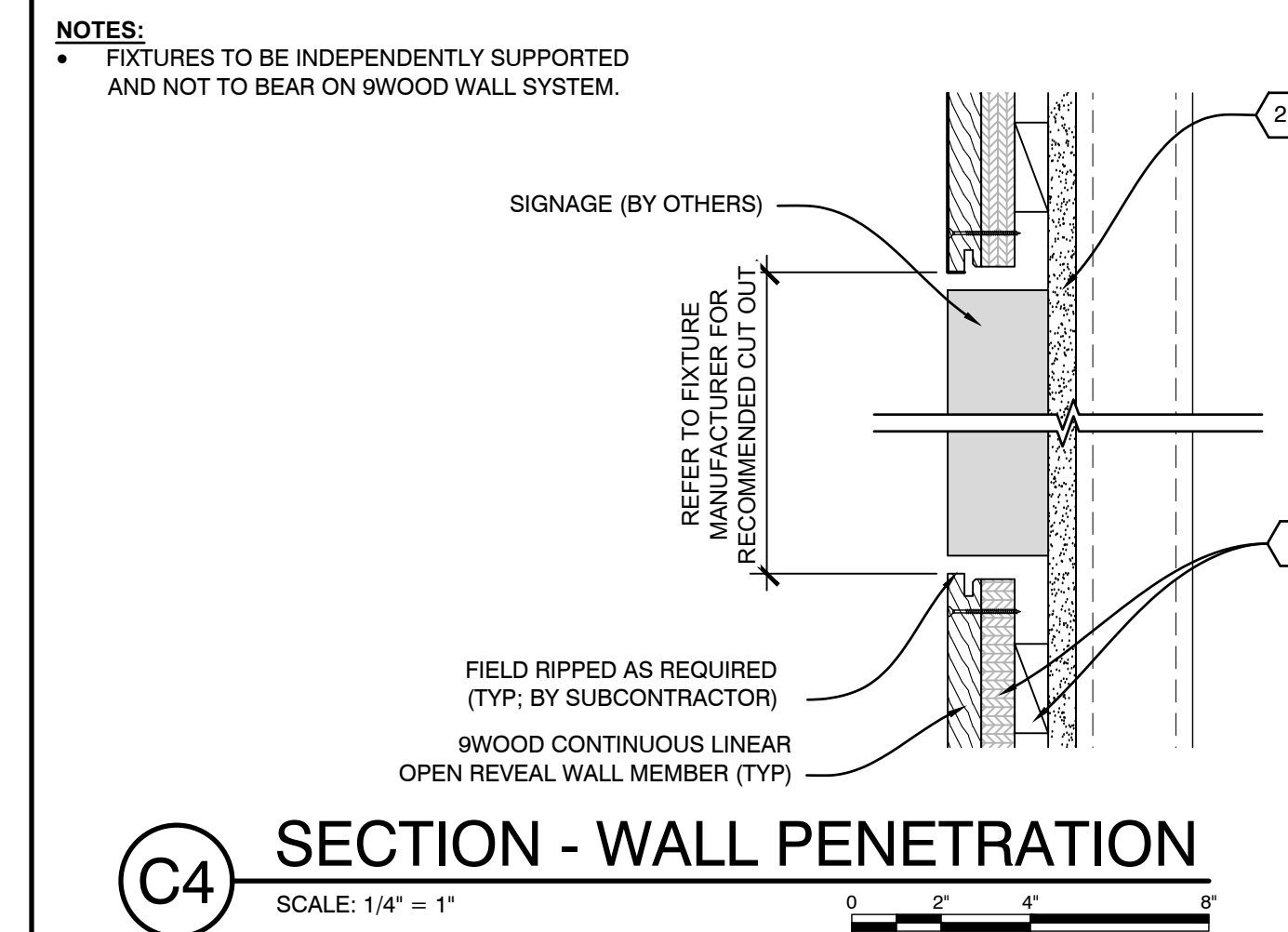

C4 SECTION - WALL PENETRATION
SCALE: 1/4" = 1"

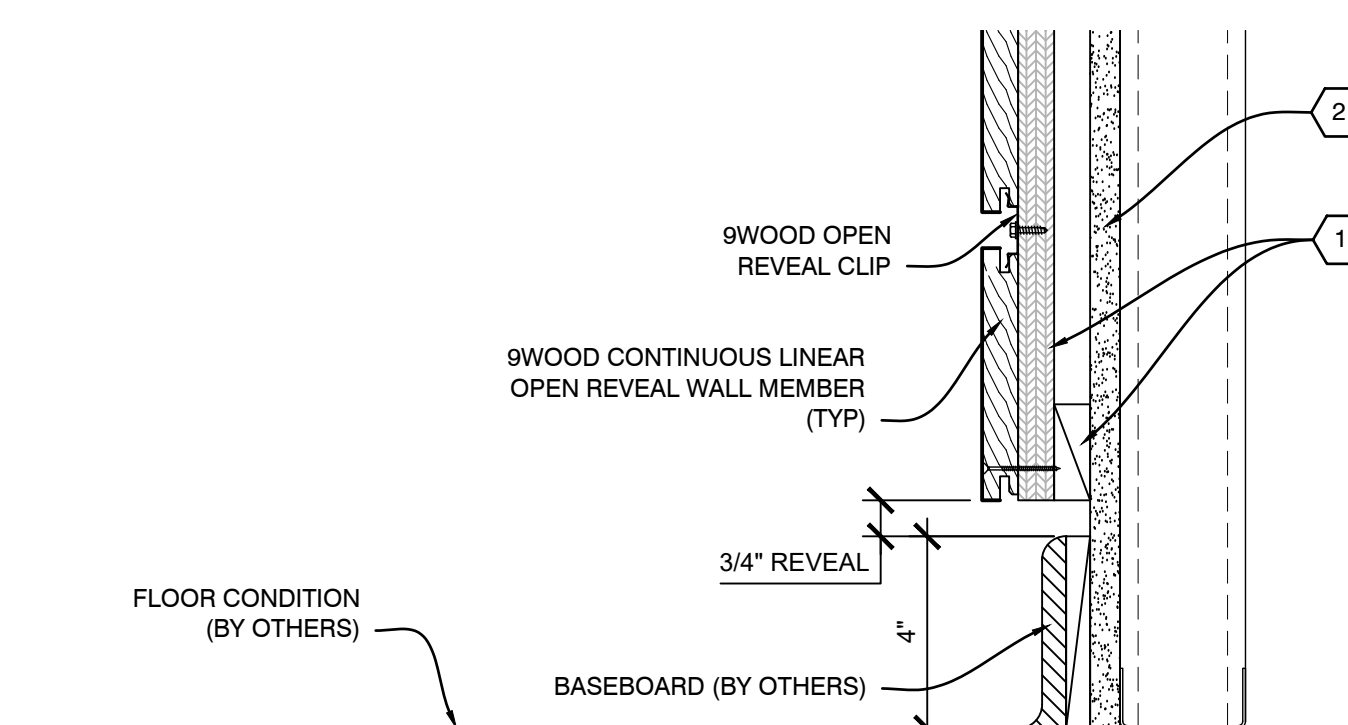

B4 SECTION - FLOOR PERIMETER
SCALE: 1/4" = 1"

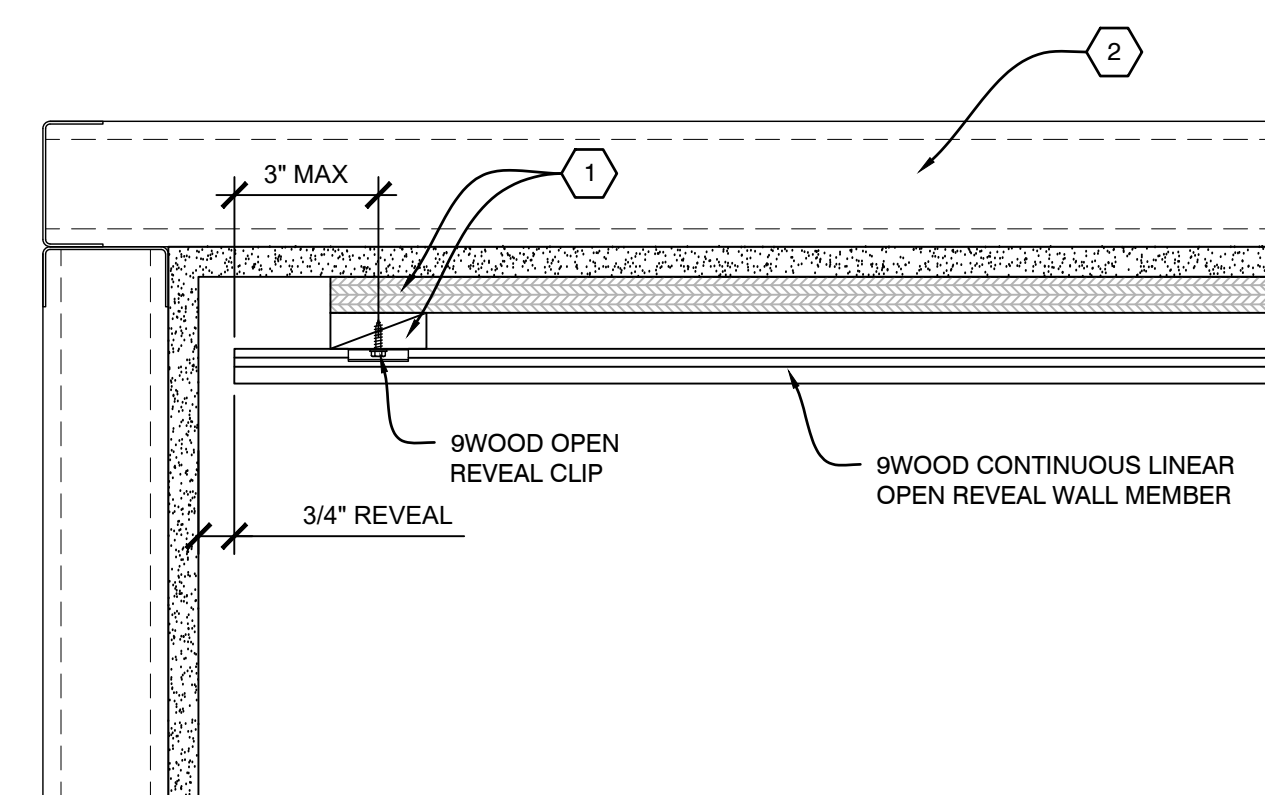

A1 PLAN VIEW - PERIMETER
SCALE: 1/4" = 1"

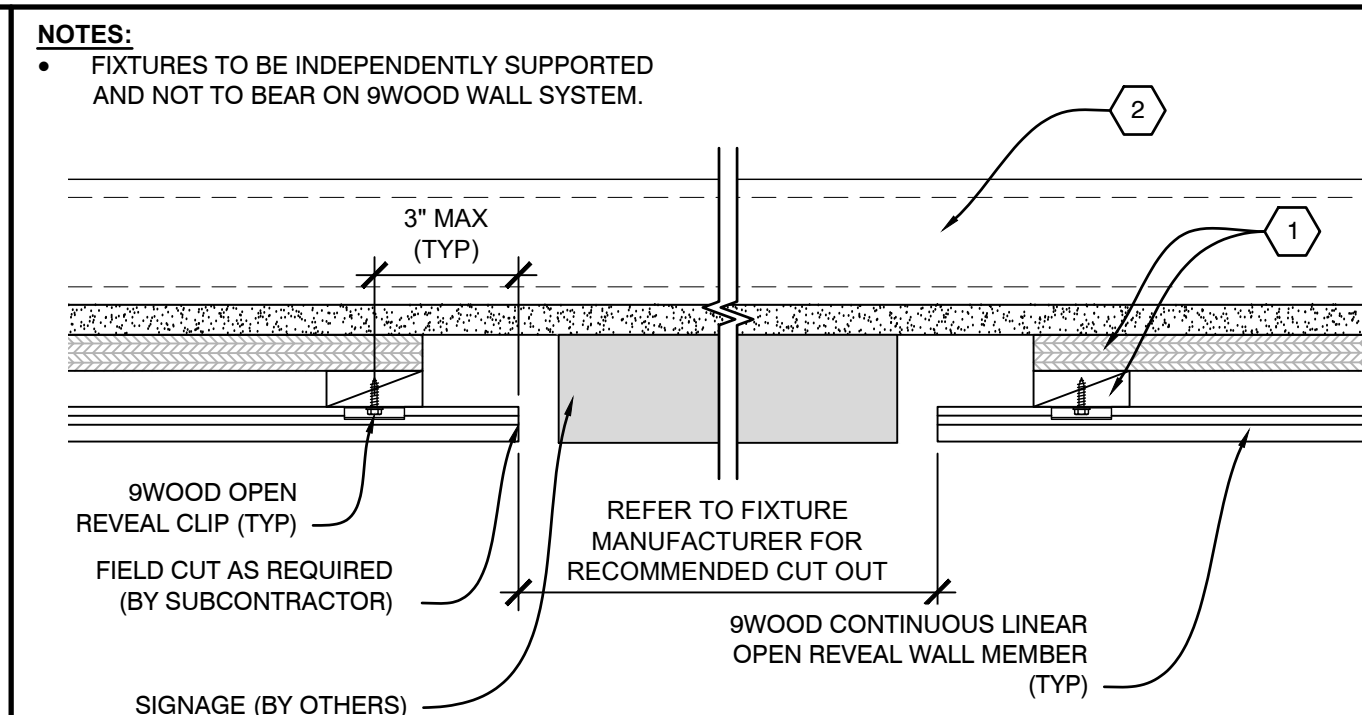

A2 PLAN VIEW - WALL PENETRATION
SCALE: 1/4" = 1"

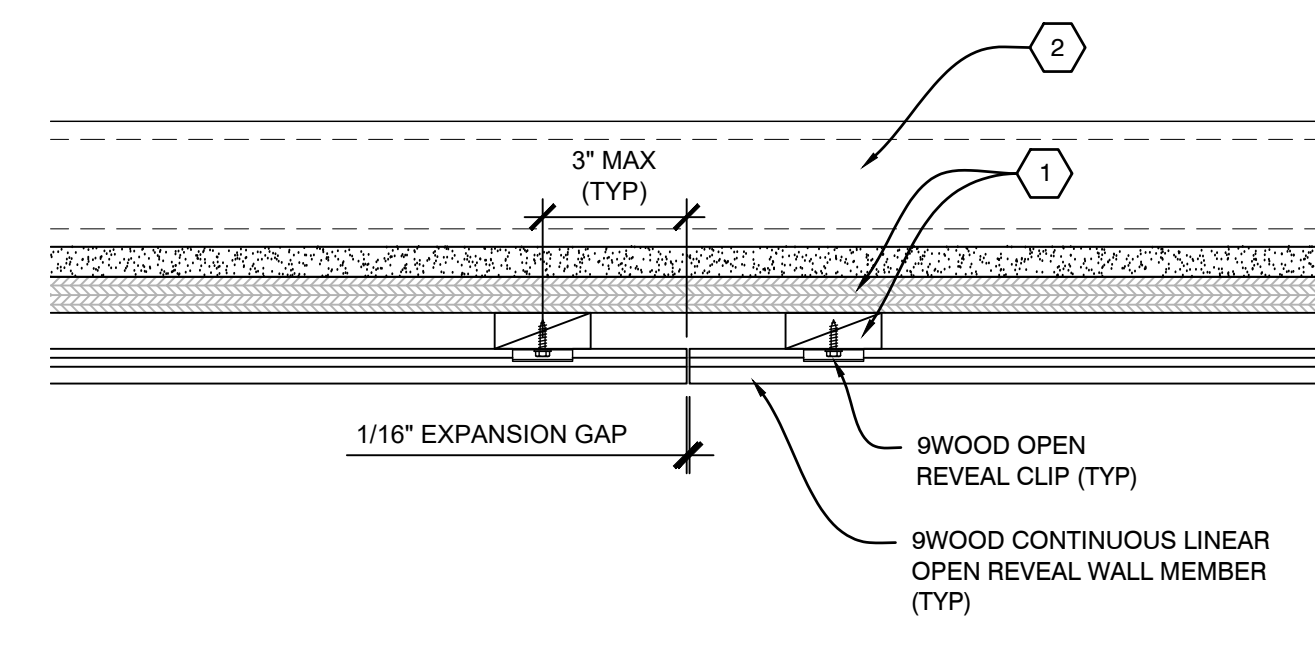

A3 PLAN VIEW - ABUTTING REVEAL
SCALE: 1/4" = 1"

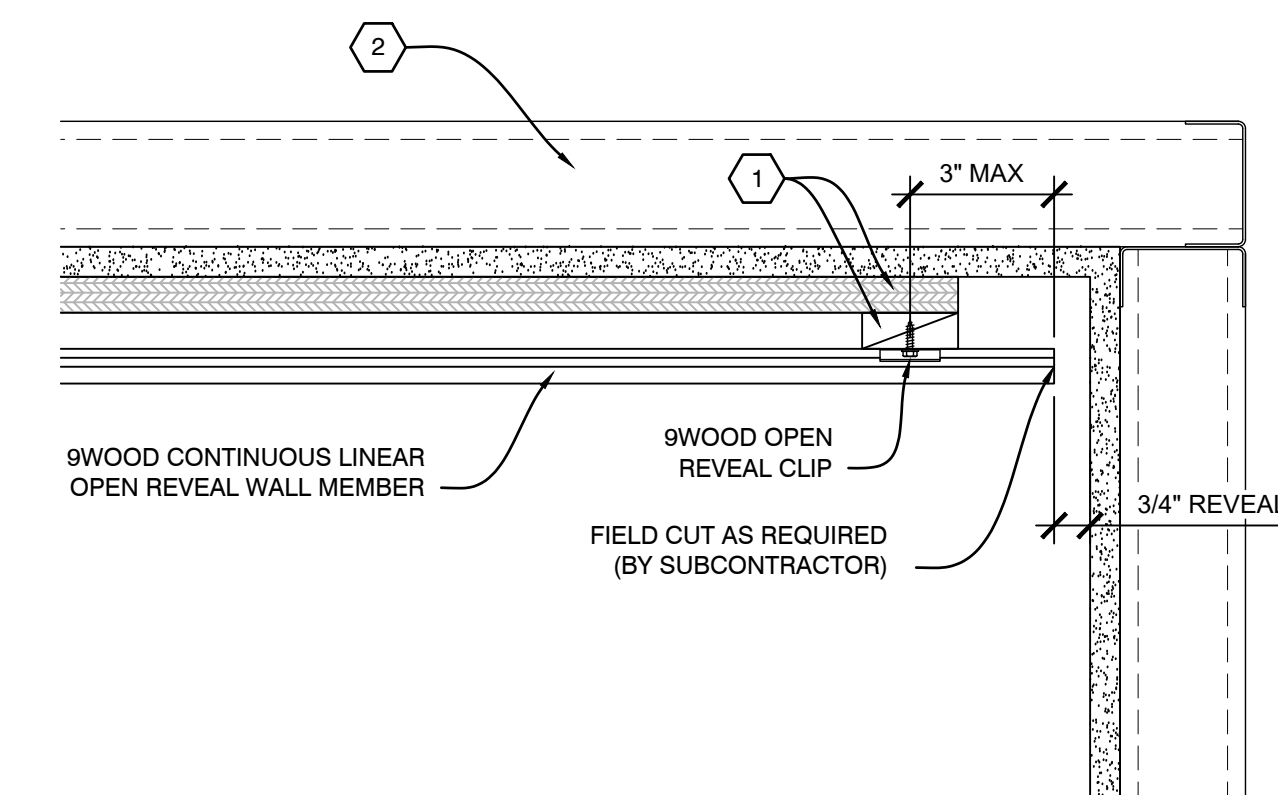

A4 PLAN VIEW - PERIMETER
SCALE: 1/4" = 1"

NOTES:
• FIXTURES TO BE INDEPENDENTLY SUPPORTED AND NOT TO BEAR ON 9WOOD WALL SYSTEM.

PROJECT

PROJECT NUMBER:

PROPOSAL NUMBER:

REVISION HISTORY

REV#	DATE	DESCRIPTION
10		
9		
8		
7		
6		
5		
4		
3		
2		
1		
0	07.24.25	RELEASE FOR APPROVALS

SHEET INFORMATION

DRAWING TYPE: SHOP DRAWINGS
DRAWN BY: RAC
STANDARDS REVIEW: JBH
TECHNICAL REVIEW: JBH

THIS DOCUMENT CONTAINS PROPRIETARY INFORMATION OF 9WOOD, INC.
COPYRIGHT © 2024 9WOOD, INC.
ALL RIGHTS RESERVED.

KEY NOTES

- ① FURRING STRIP (TYP; BY SUBCONTRACTOR)
- ② WALL CONDITION (TYP; BY OTHERS)

SHEET TITLE

SYSTEM DETAILS

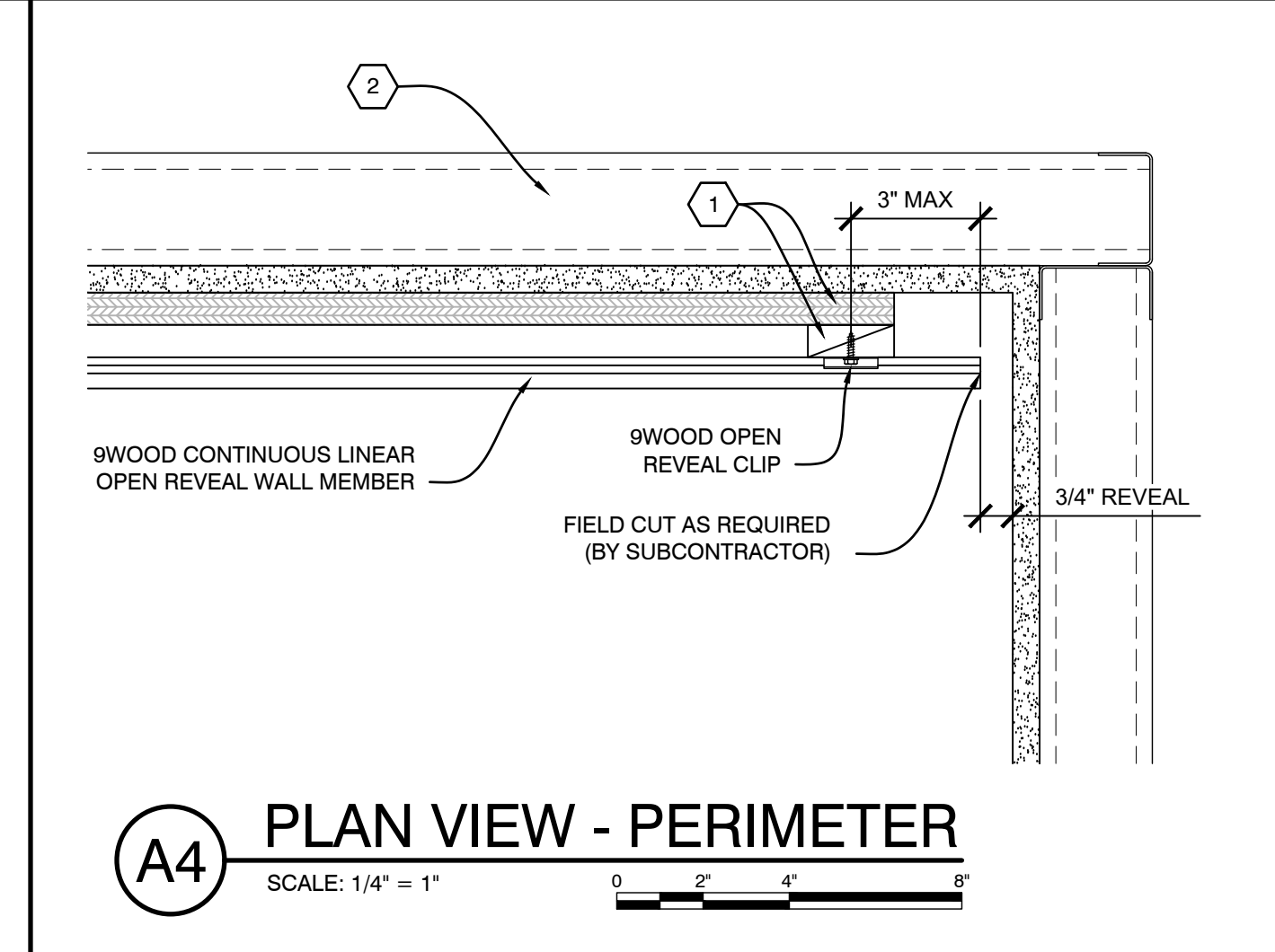
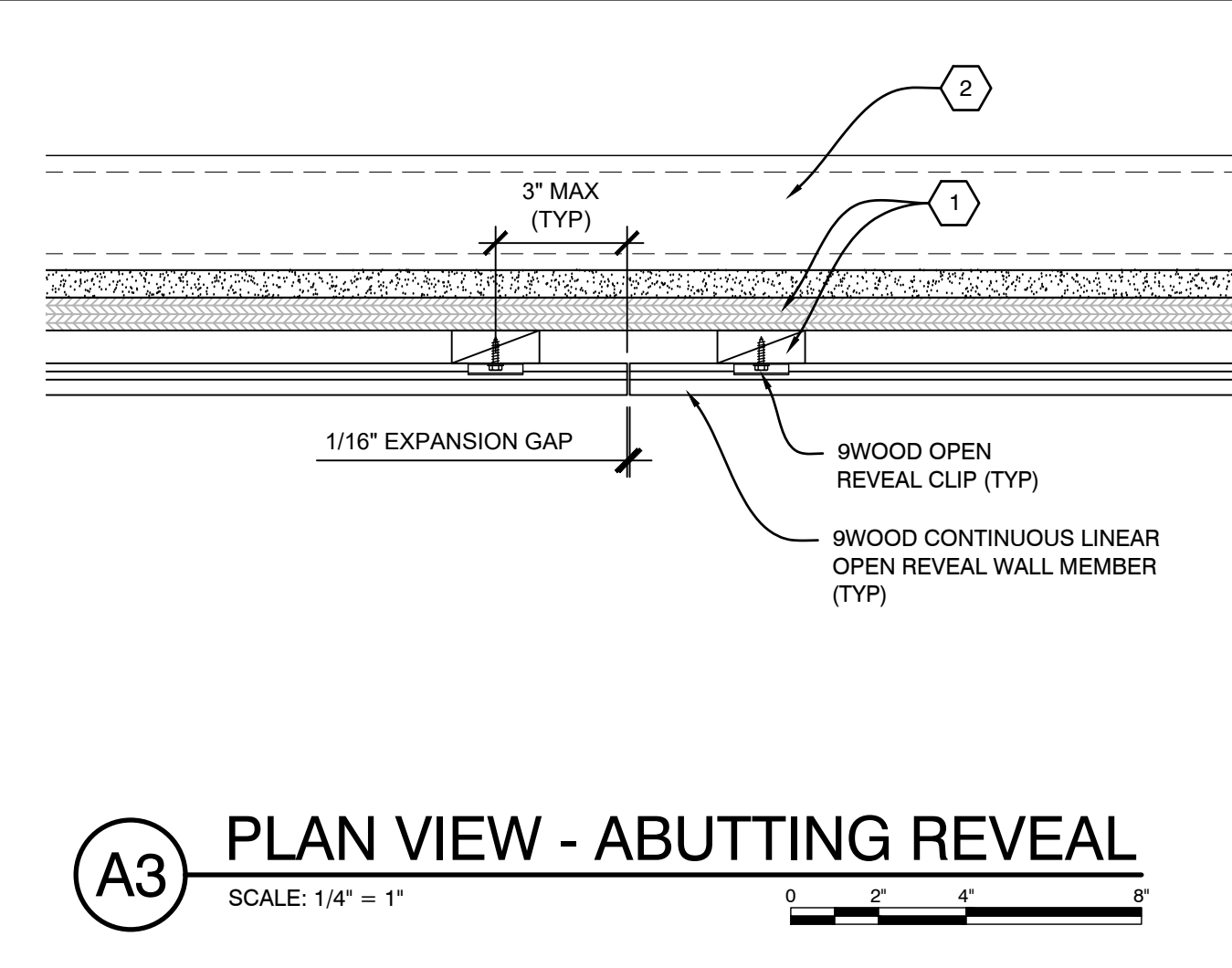
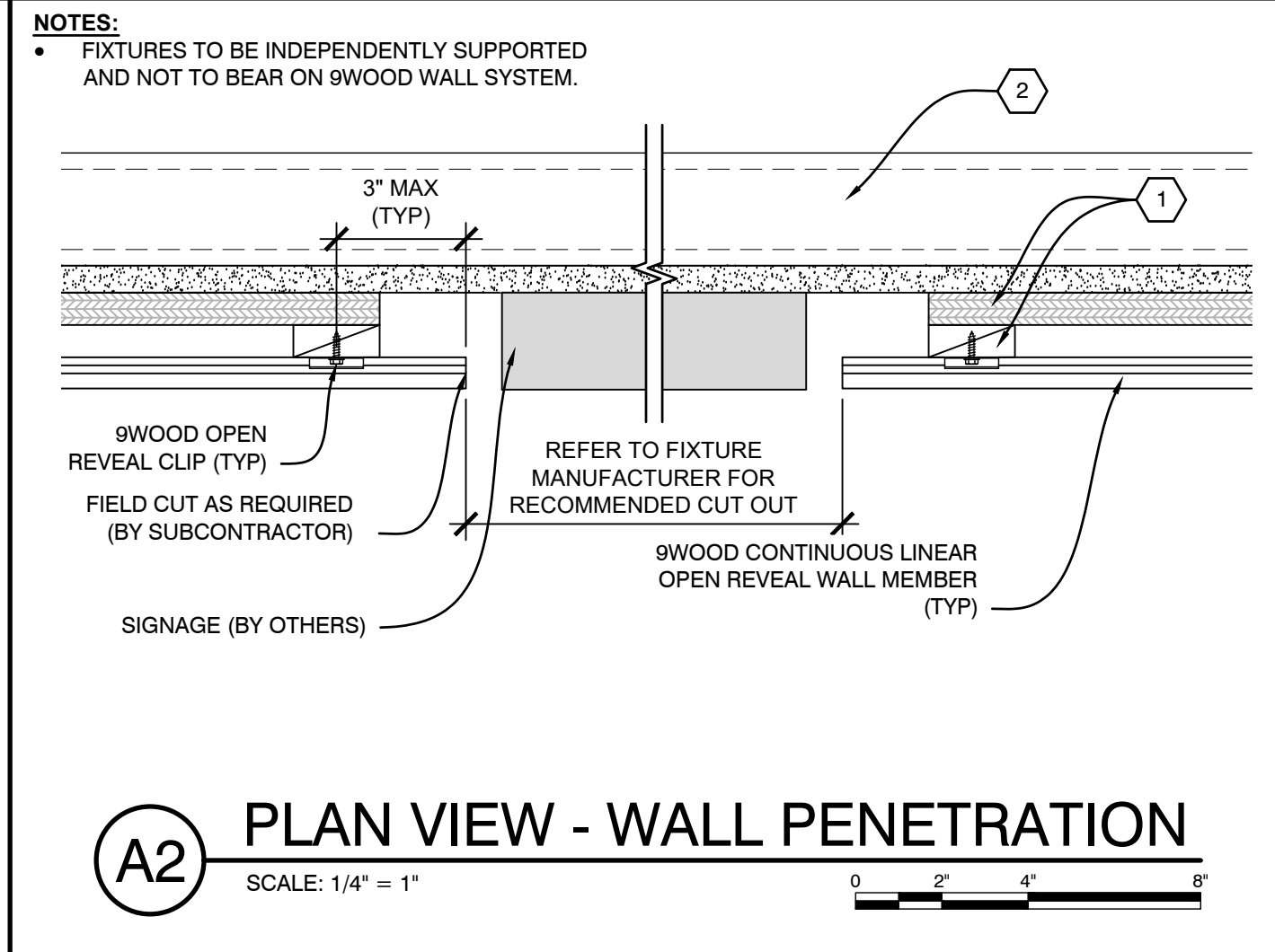
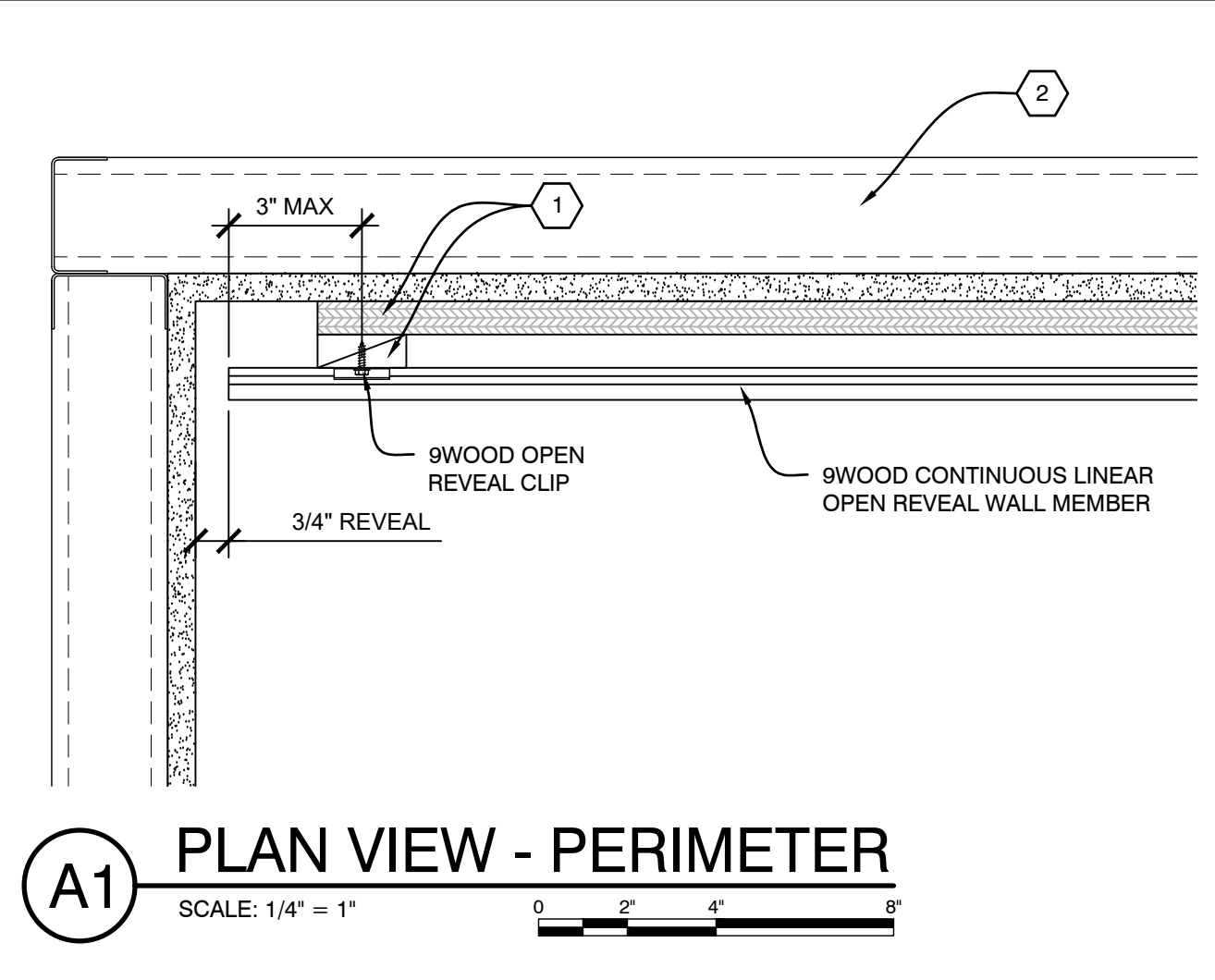
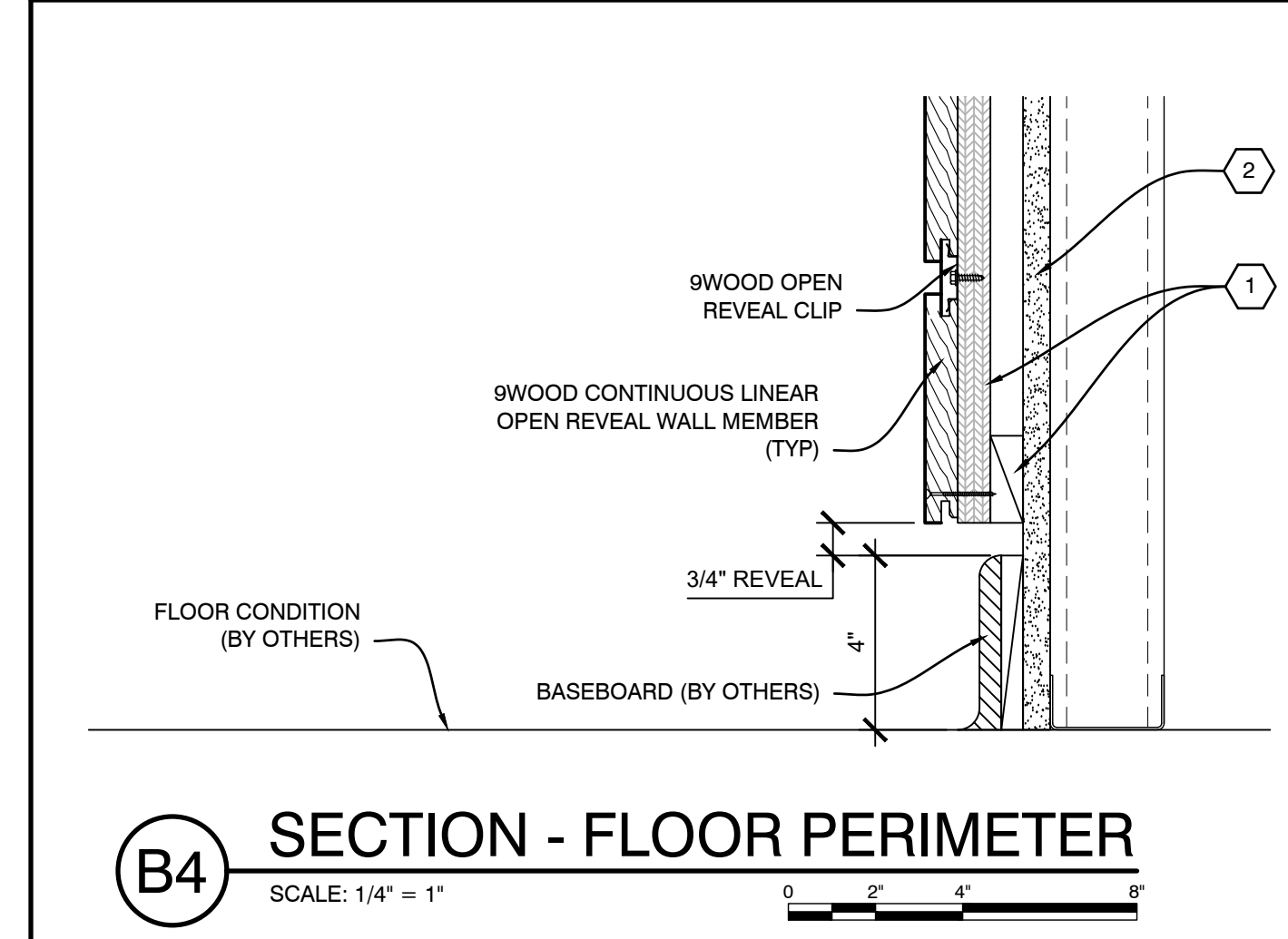
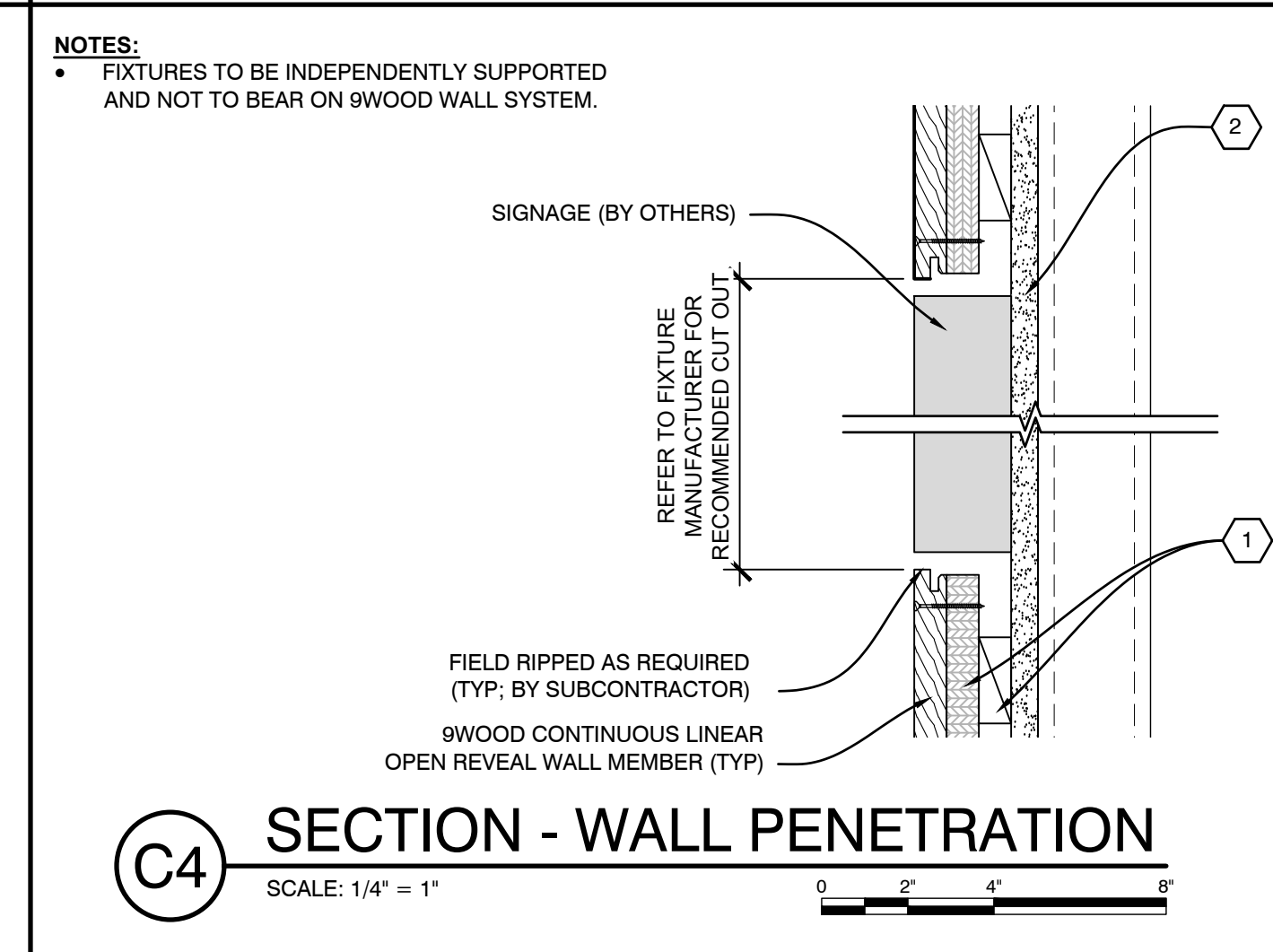
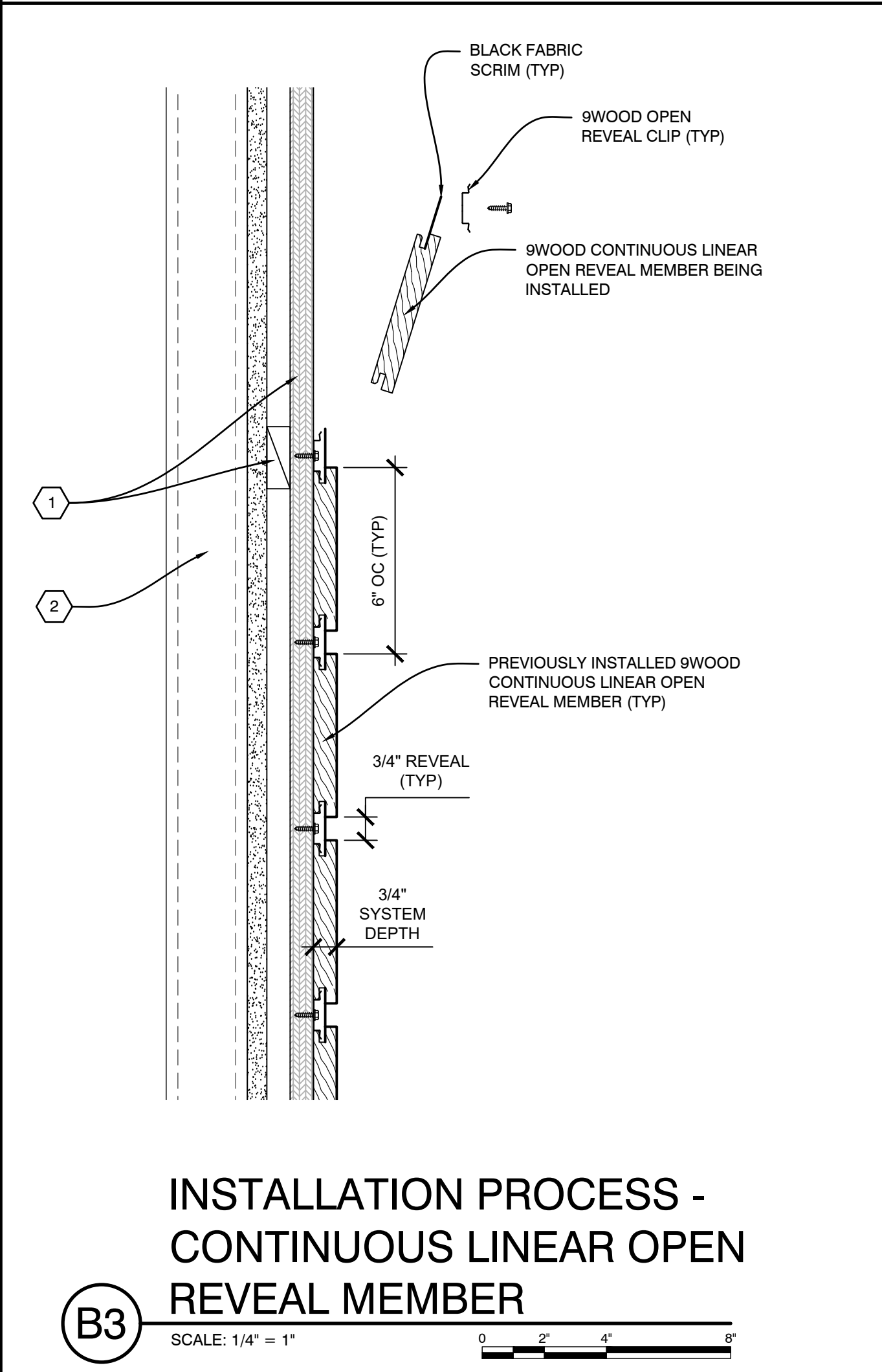
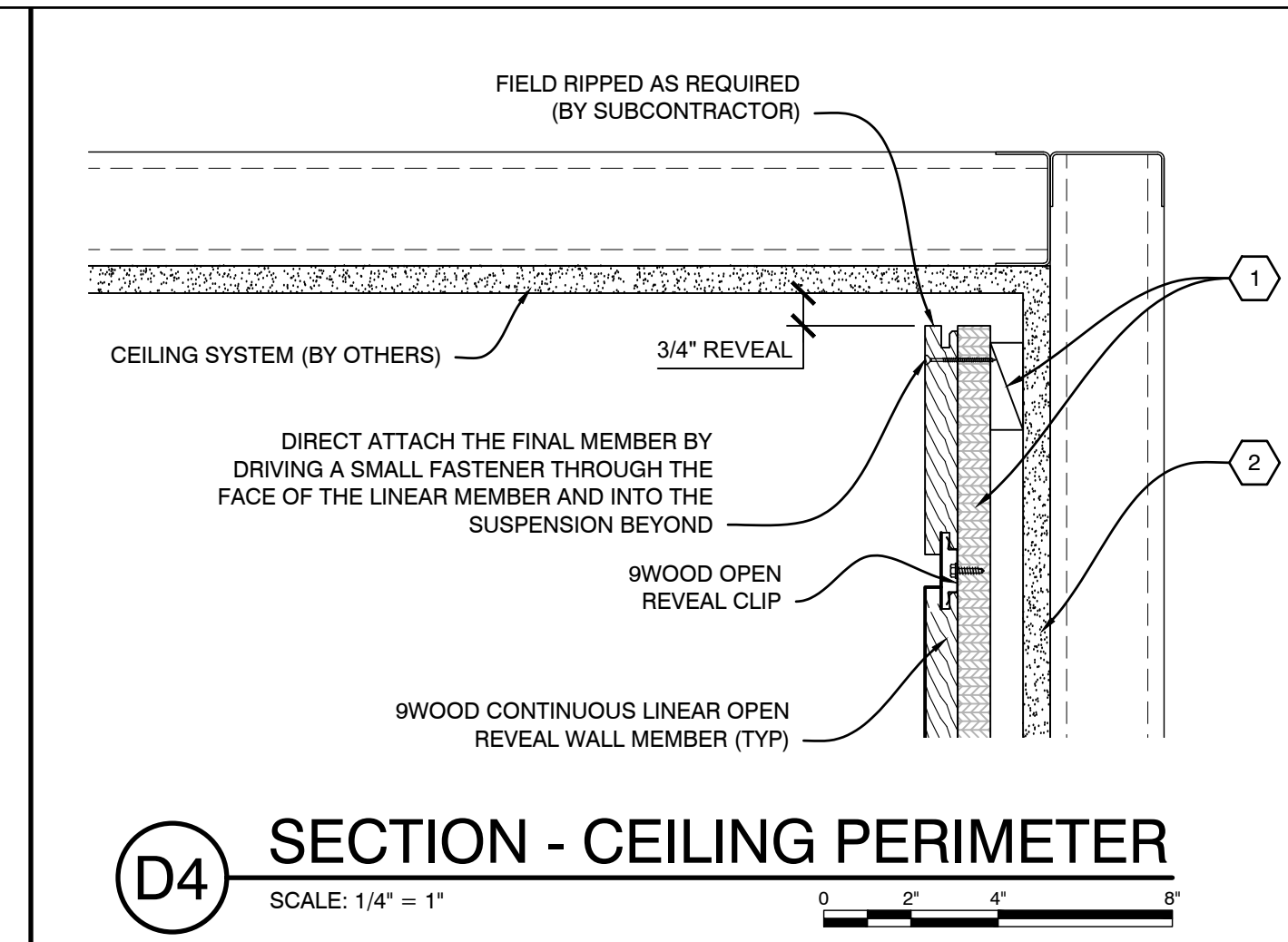
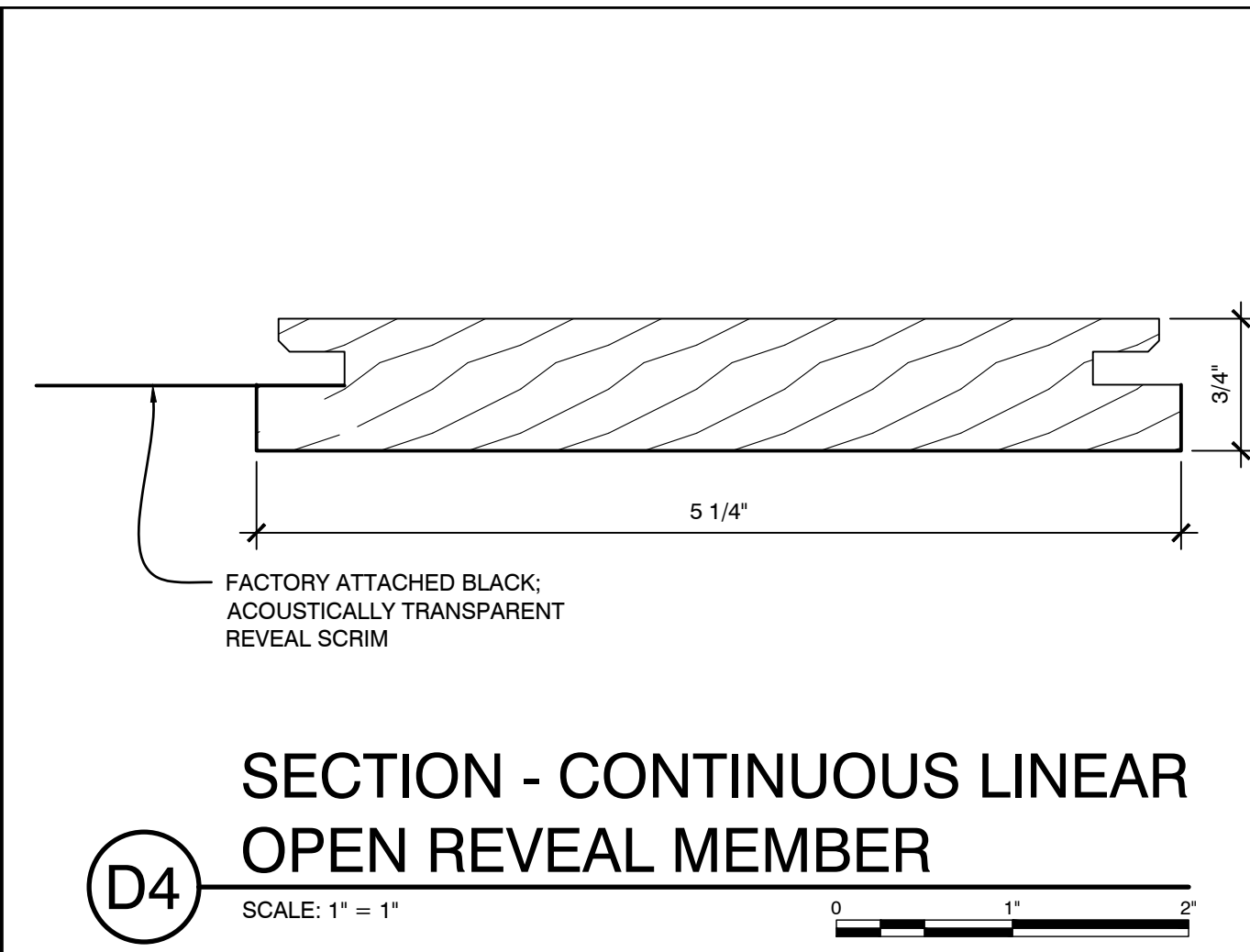

9WOOD IS A REGISTERED TRADEMARK OF 9WOOD, INC. © 2024 9WOOD, INC. ALL RIGHTS RESERVED.
 9WOOD OPEN REVEAL CLIP (TYP) IS A REGISTERED TRADEMARK OF 9WOOD, INC. © 2024 9WOOD, INC. ALL RIGHTS RESERVED.
 9WOOD CONTINUOUS LINEAR OPEN REVEAL WALL MEMBER (TYP) IS A REGISTERED TRADEMARK OF 9WOOD, INC. © 2024 9WOOD, INC. ALL RIGHTS RESERVED.

PROJECT

PROJECT NUMBER:
PROPOSAL NUMBER:

REVISION HISTORY

REV#	DATE	DESCRIPTION
10		
9		
8		
7		
6		
5		
4		
3		
2		
1		
0	07.24.25	RELEASE FOR APPROVALS

SHEET INFORMATION

DRAWING TYPE: SHOP DRAWINGS
DRAWN BY: RAC
STANDARDS REVIEW: JBH
TECHNICAL REVIEW: JBH

THIS DOCUMENT CONTAINS PROPRIETARY INFORMATION OF 9WOOD, INC.
COPYRIGHT © 2024 9WOOD, INC.
ALL RIGHTS RESERVED.

KEY NOTES

- 1 FURRING STRIP (TYP; BY SUBCONTRACTOR)
- 2 WALL CONDITION (TYP; BY OTHERS)

SHEET TITLE

SYSTEM DETAILS

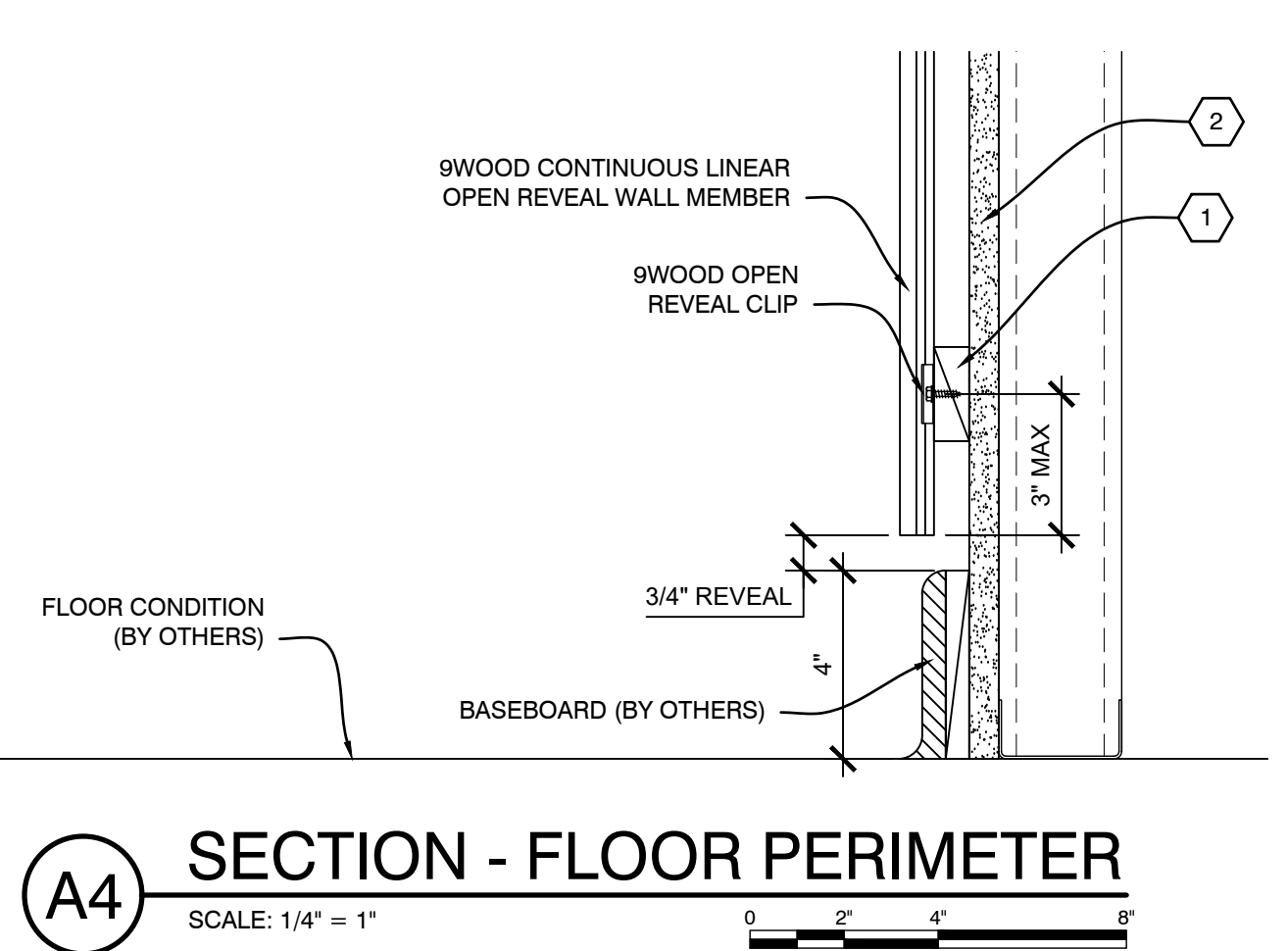
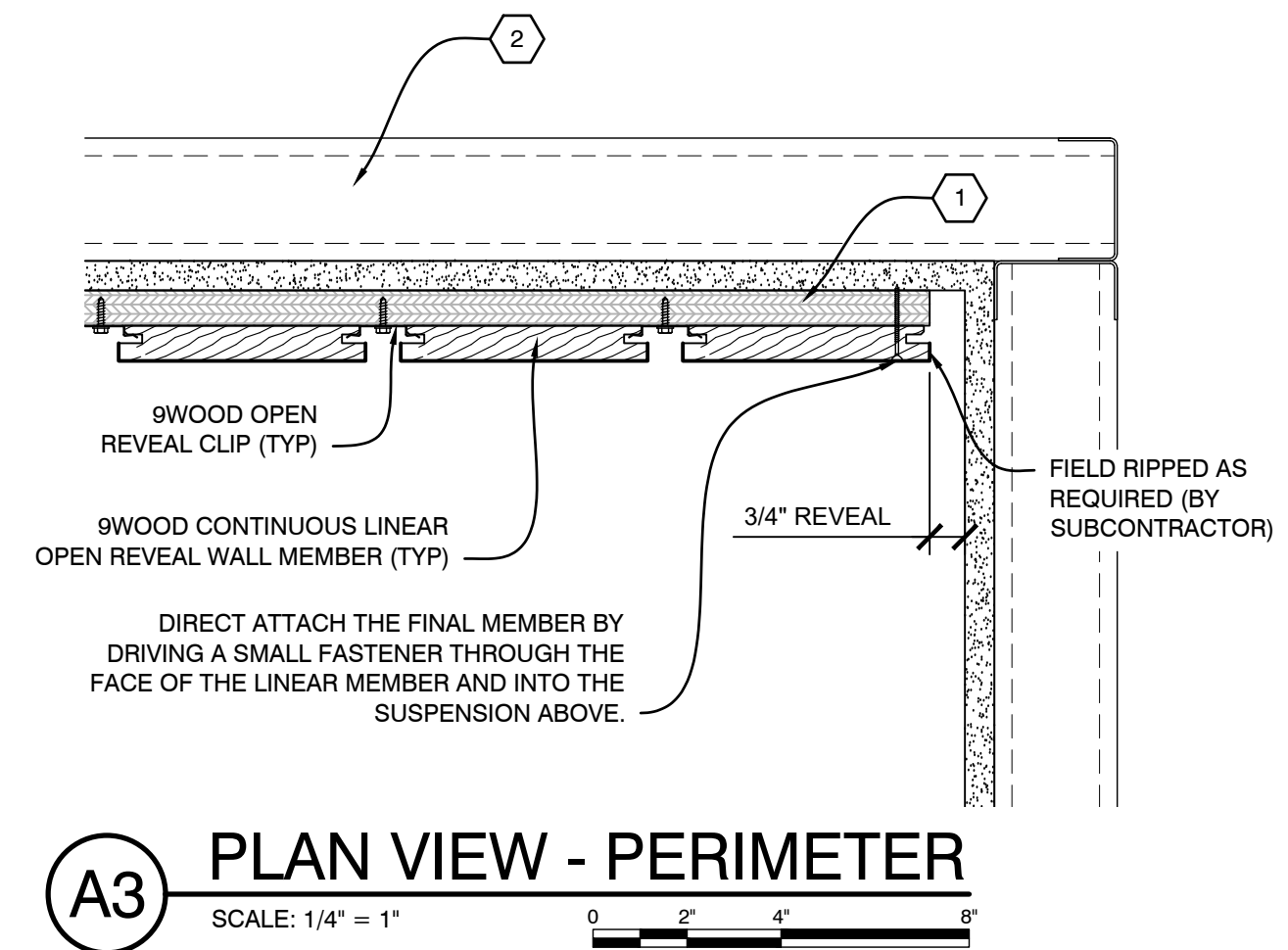
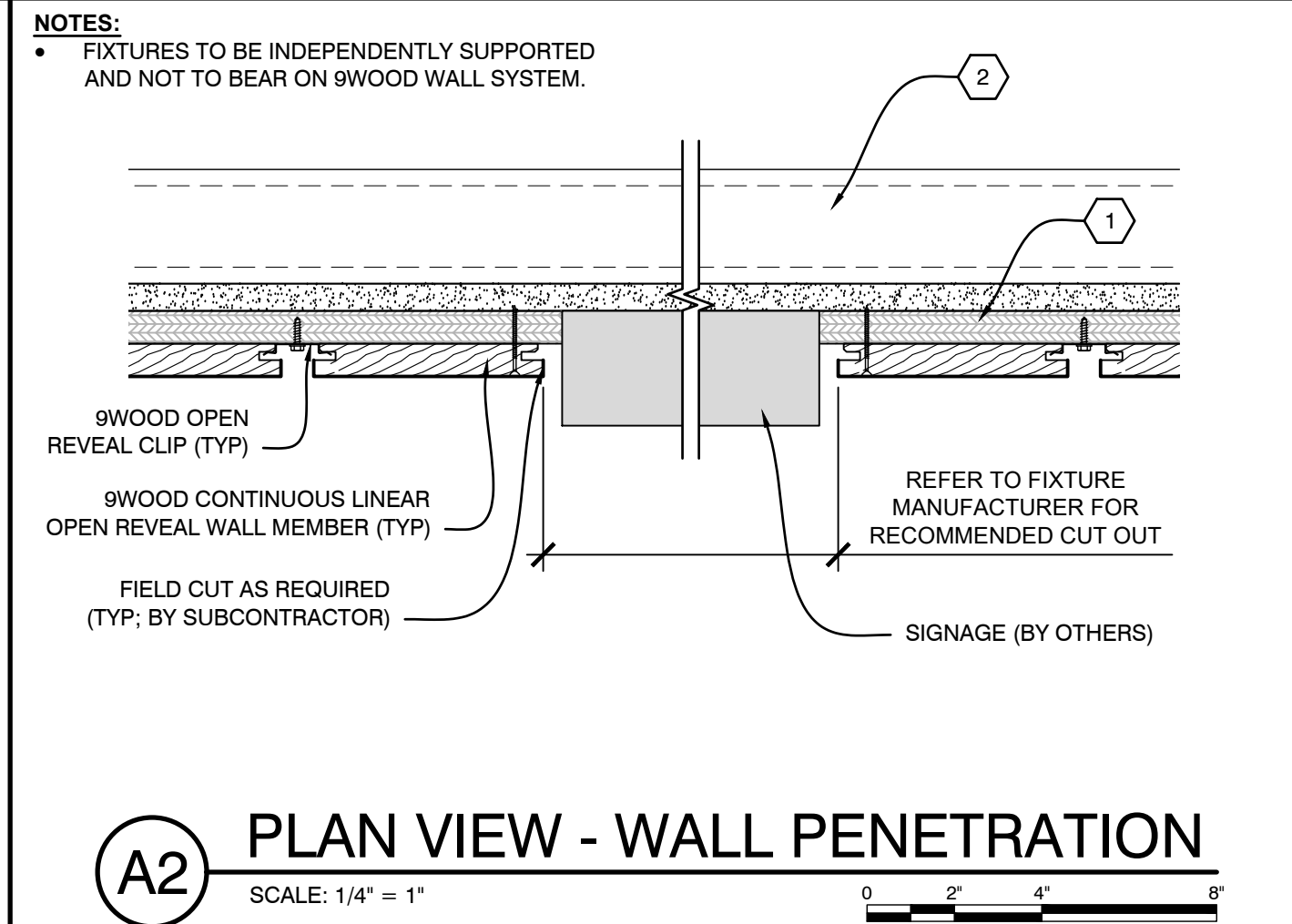
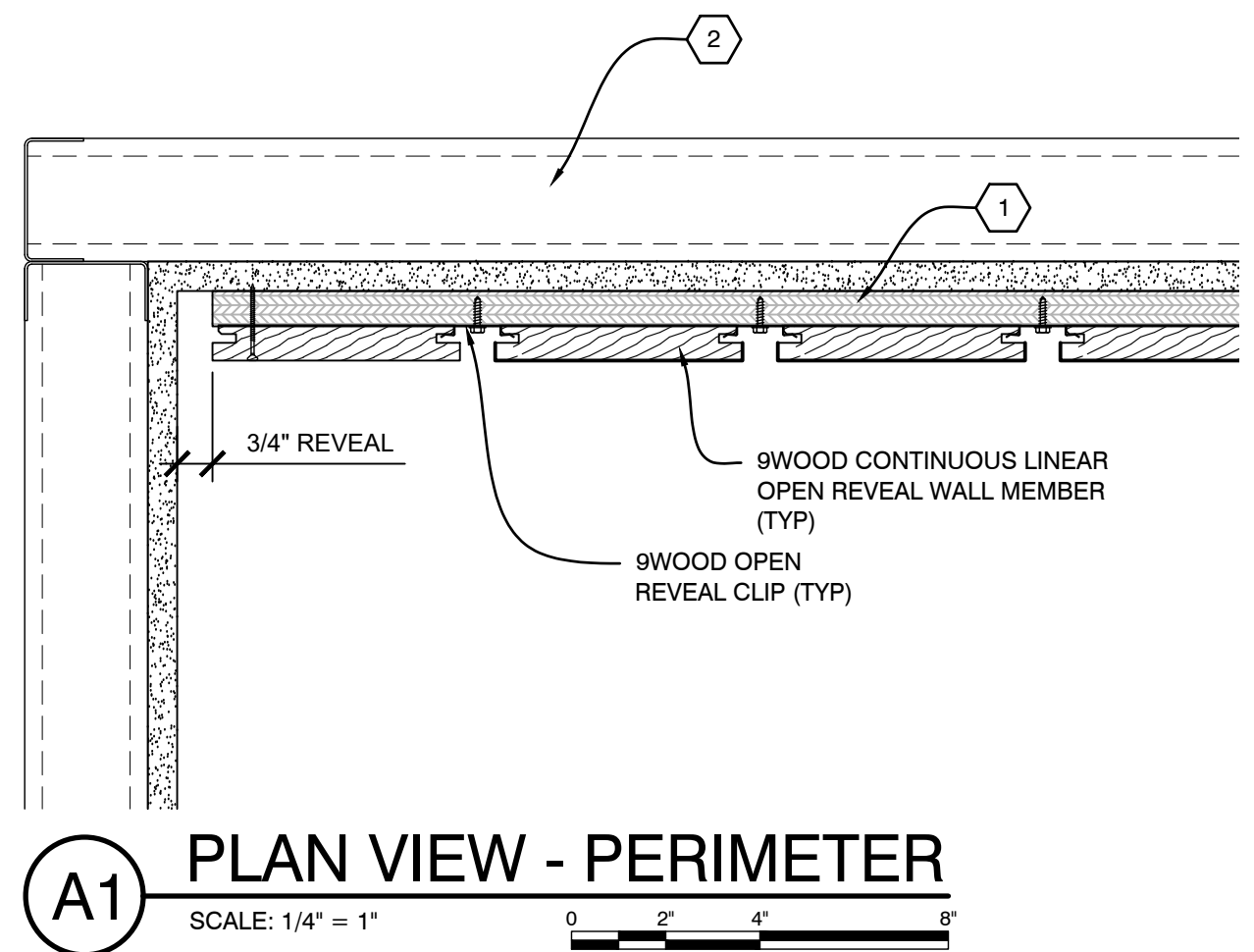
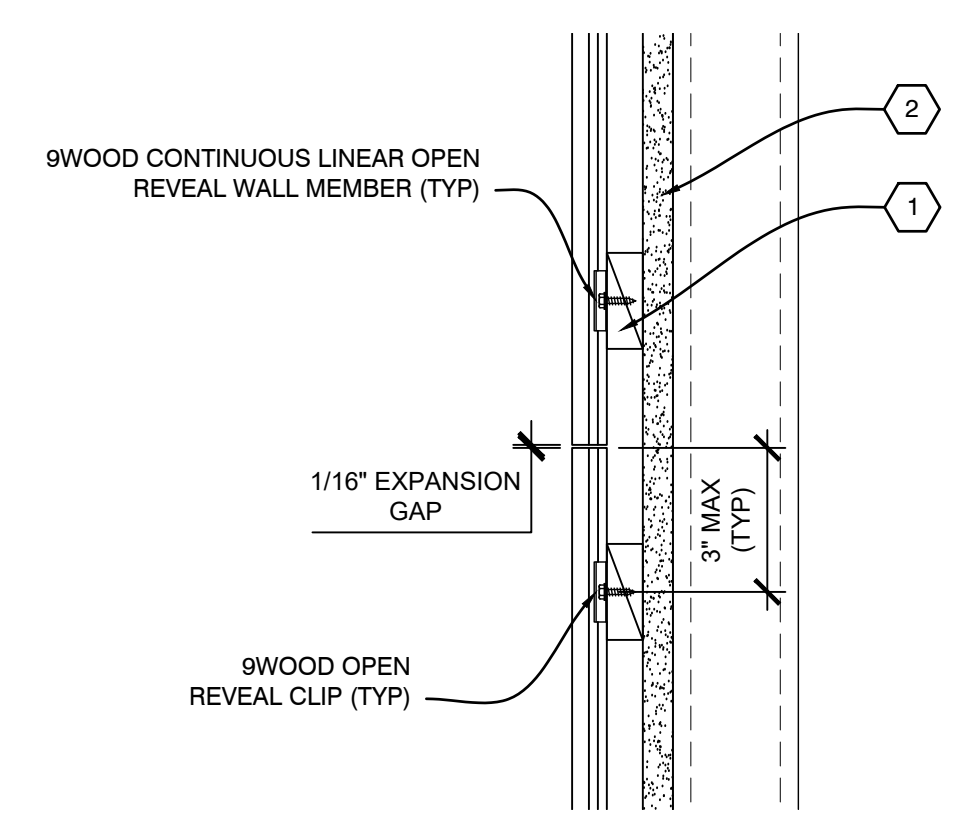
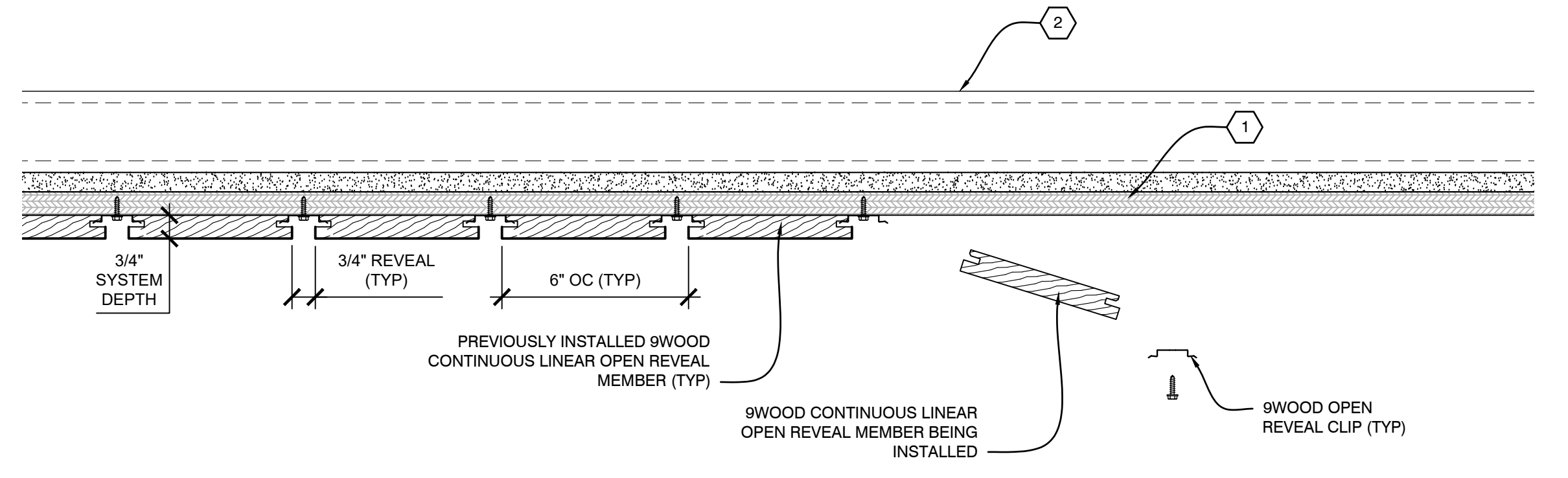
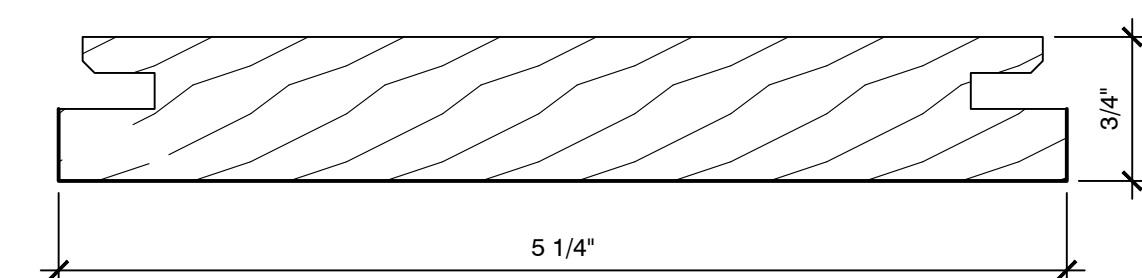
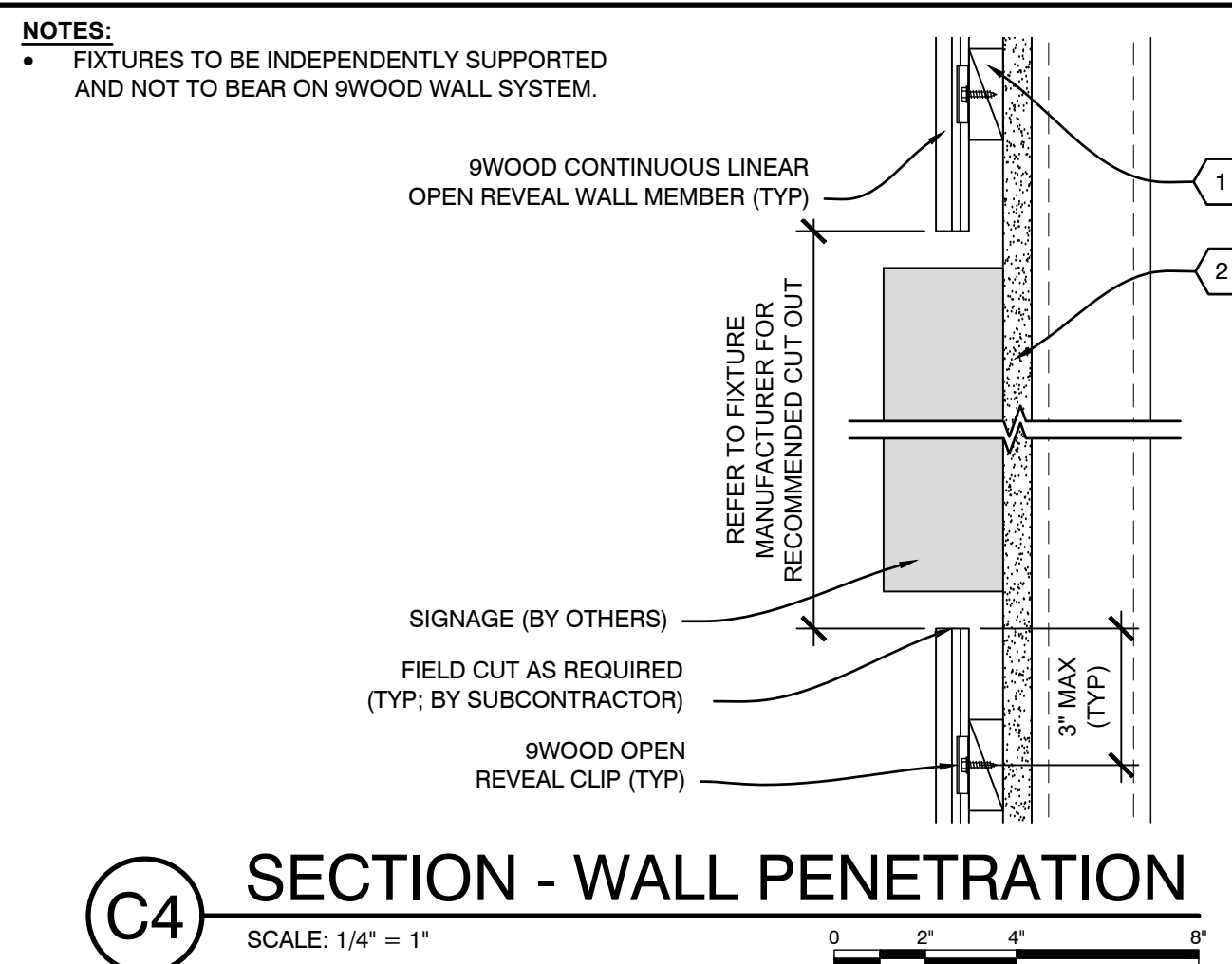
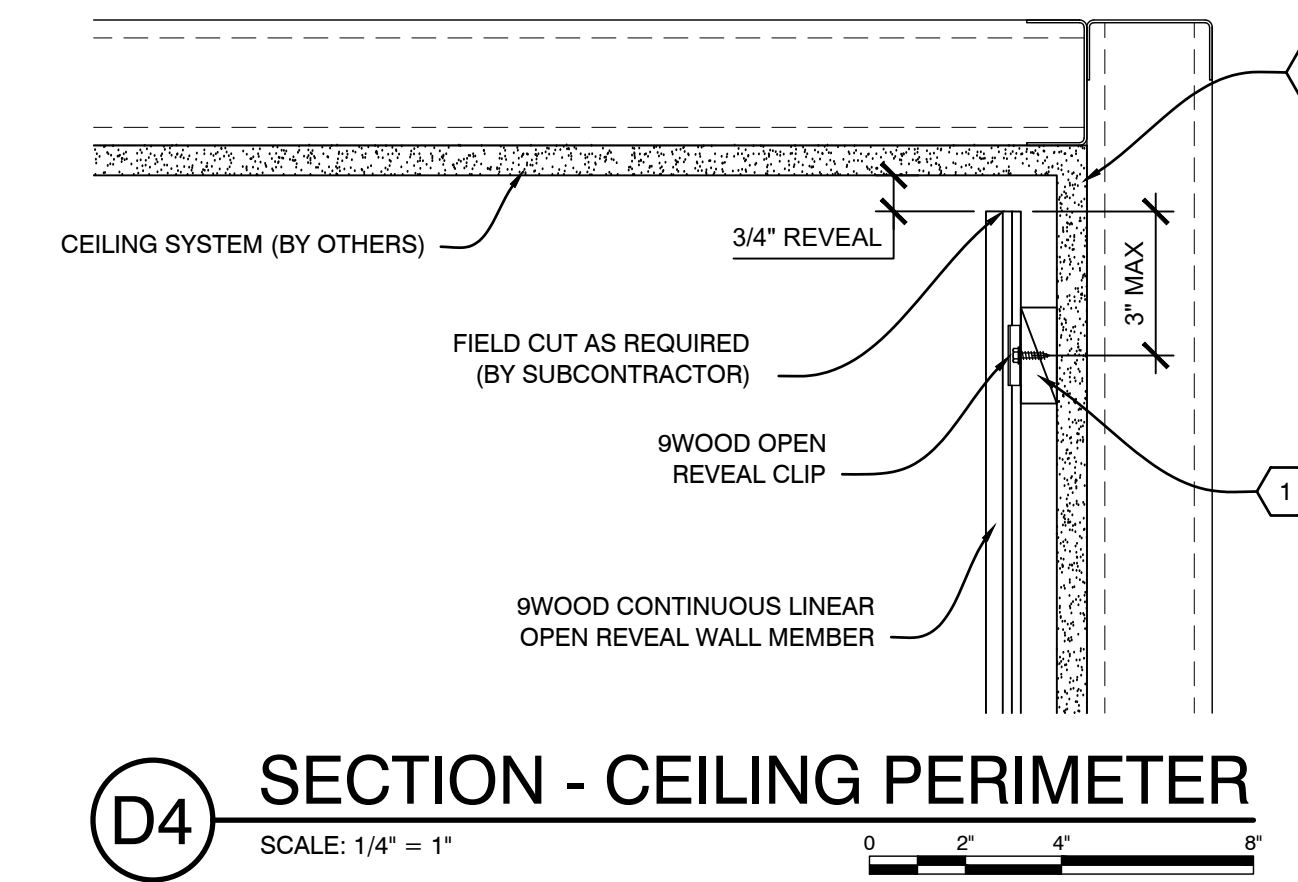

9WOOD IS A REGISTERED TRADEMARK OF 9WOOD, INC. © 2024 9WOOD, INC. ALL RIGHTS RESERVED. 9WOOD IS A REGISTERED TRADEMARK OF 9WOOD, INC. © 2024 9WOOD, INC. ALL RIGHTS RESERVED.

