

D3 PLAN VIEW - CROSS PIECE BACKER WOOD GRILLE
SCALE: 1 1/2" = 1"

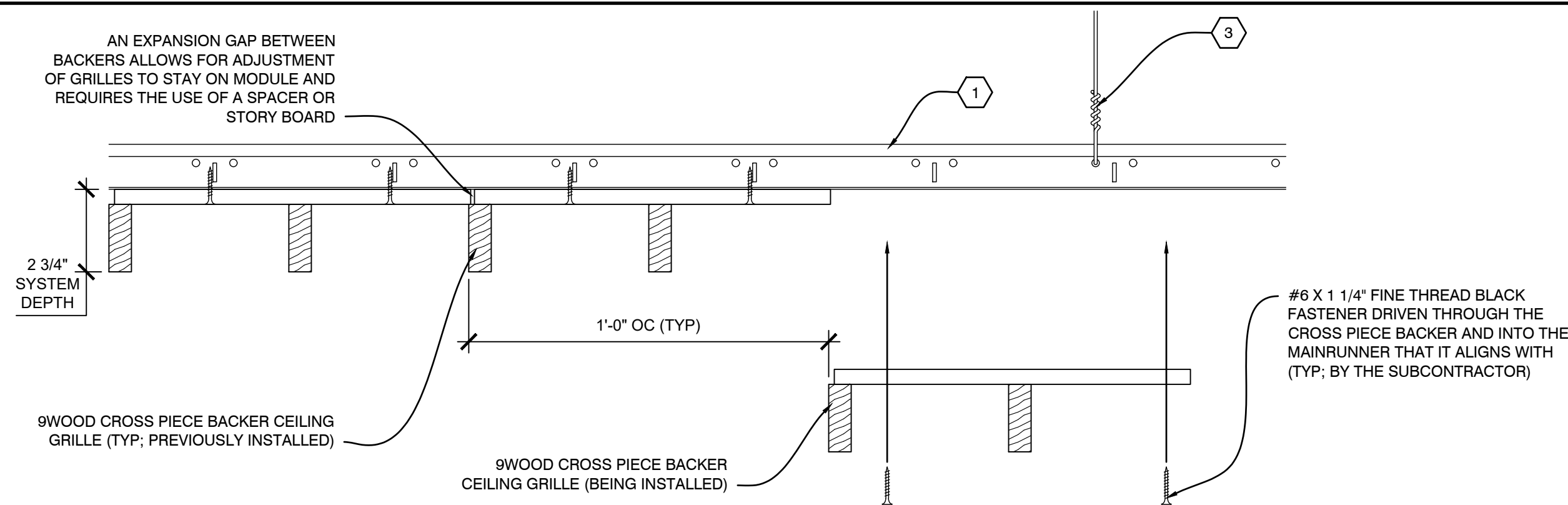

C1 INSTALLATION PROCESS - CROSS PIECE BACKER WOOD GRILLE
SCALE: 1/4" = 1"

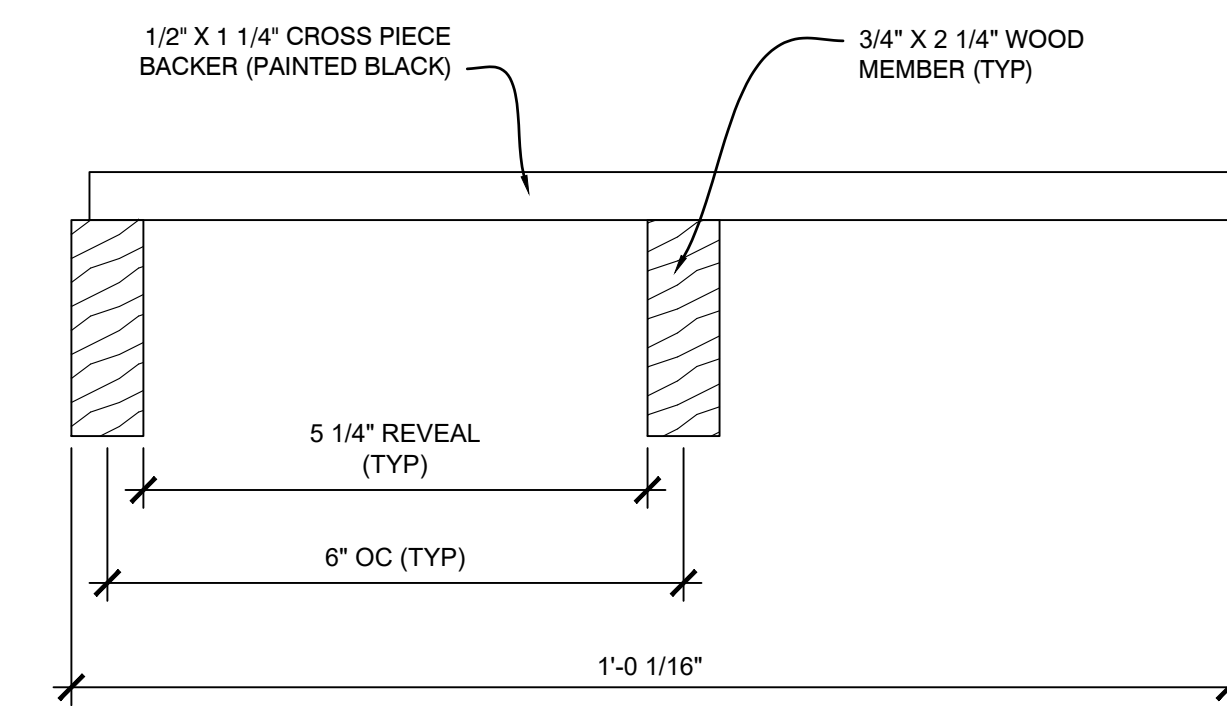

C3 SECTION - CROSS PIECE BACKER WOOD GRILLE
SCALE: 1/2" = 1"

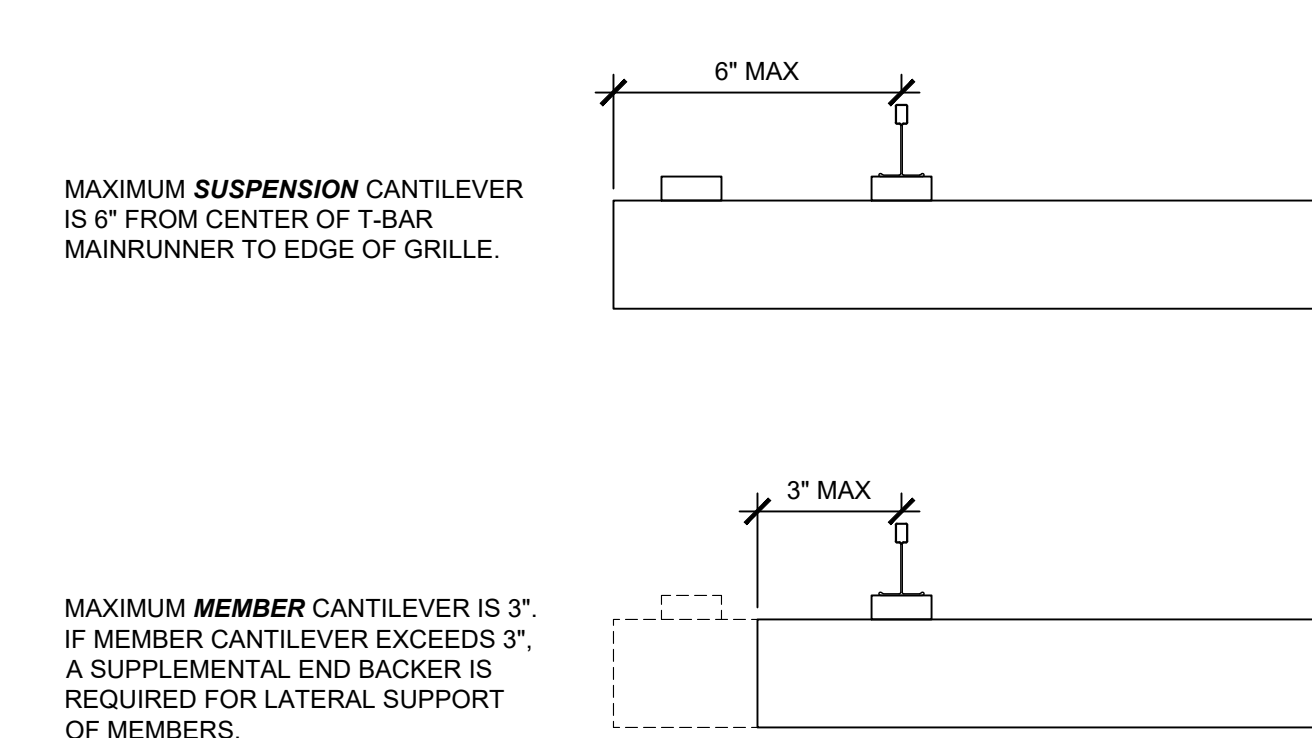

C4 SECTION - CANTILEVER RULES
SCALE: 1/4" = 1"

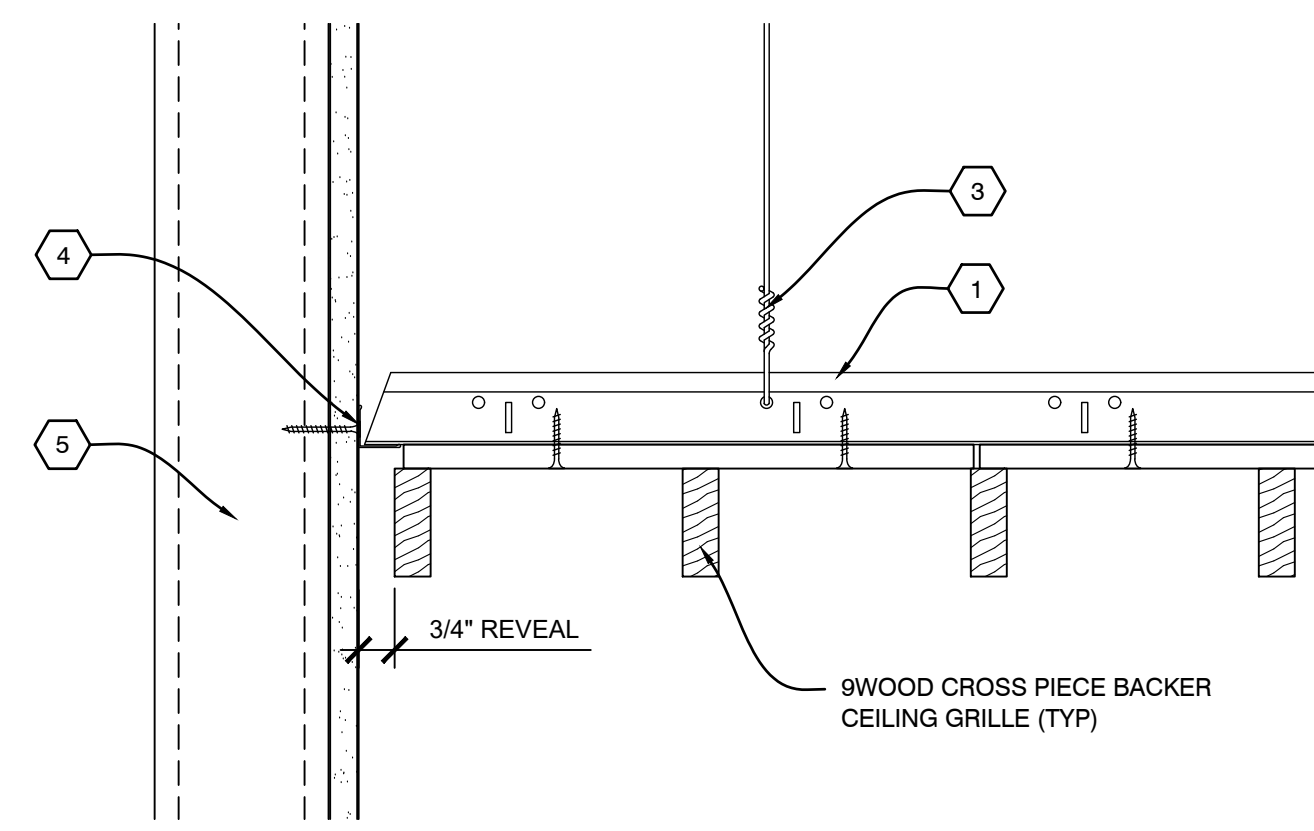

B1 SECTION - PERIMETER
SCALE: 1/4" = 1"

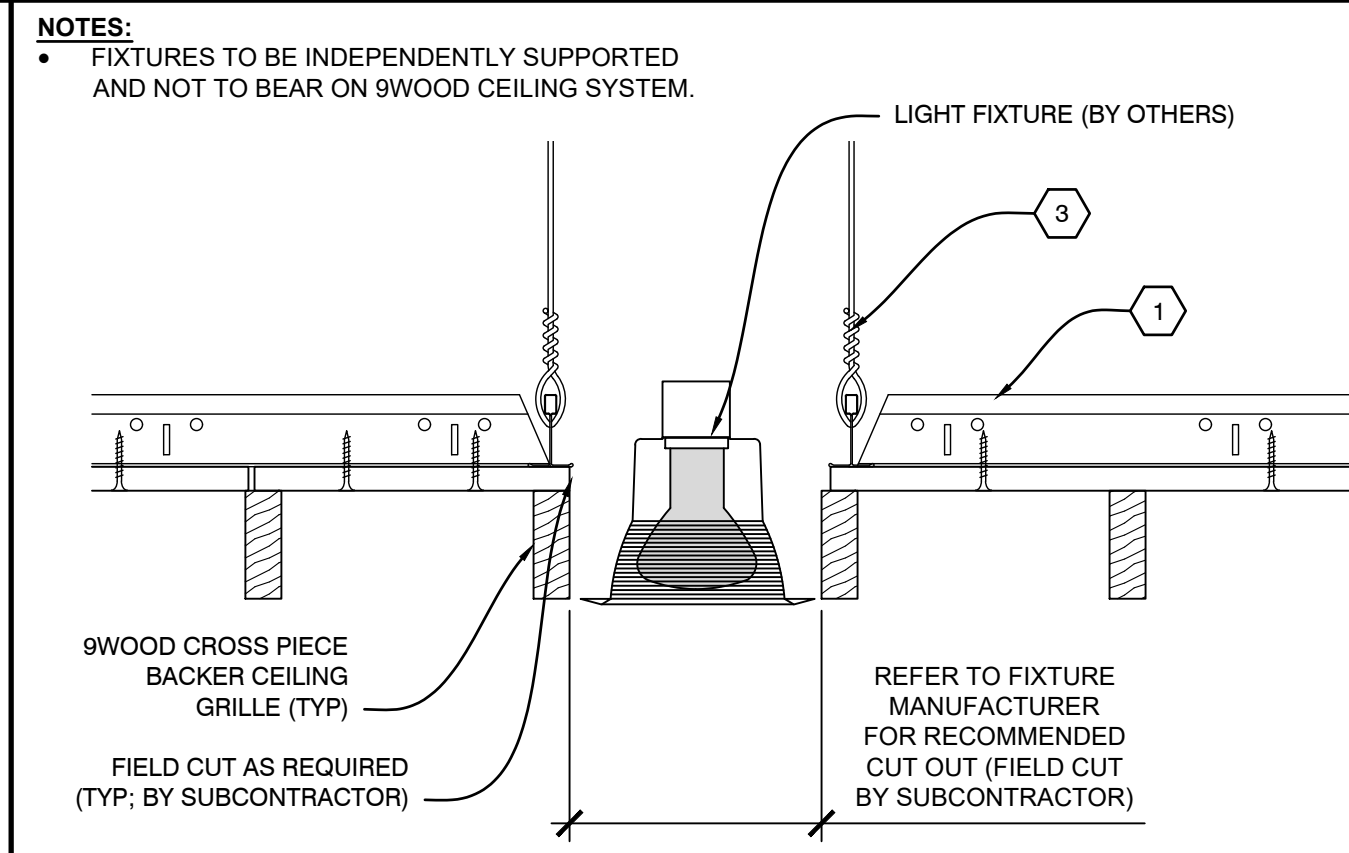

B2 SECTION - LIGHT FIXTURE
SCALE: 1/4" = 1"

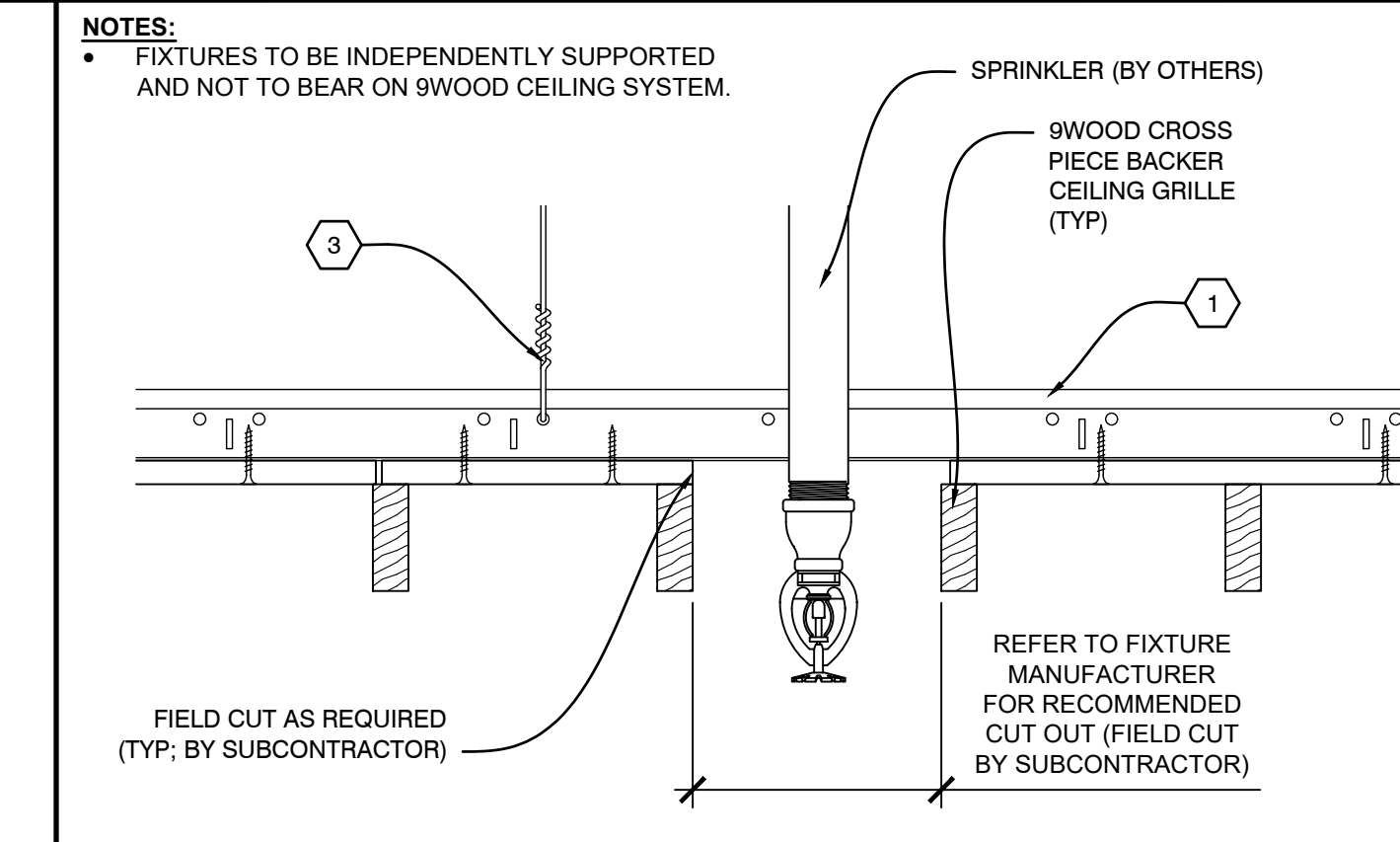

B3 SECTION - SPRINKLER
SCALE: 1/4" = 1"

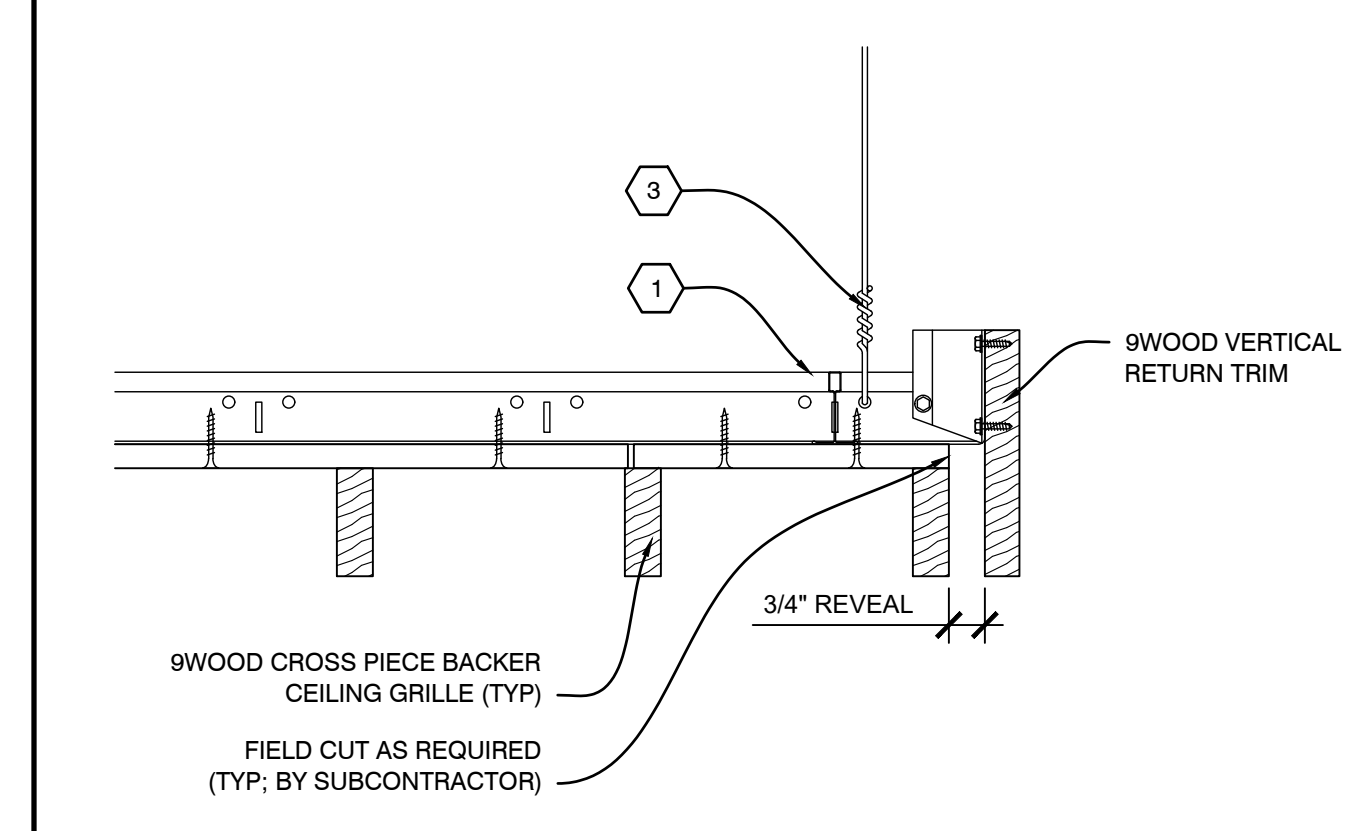

B4 SECTION - PERIMETER
SCALE: 1/4" = 1"

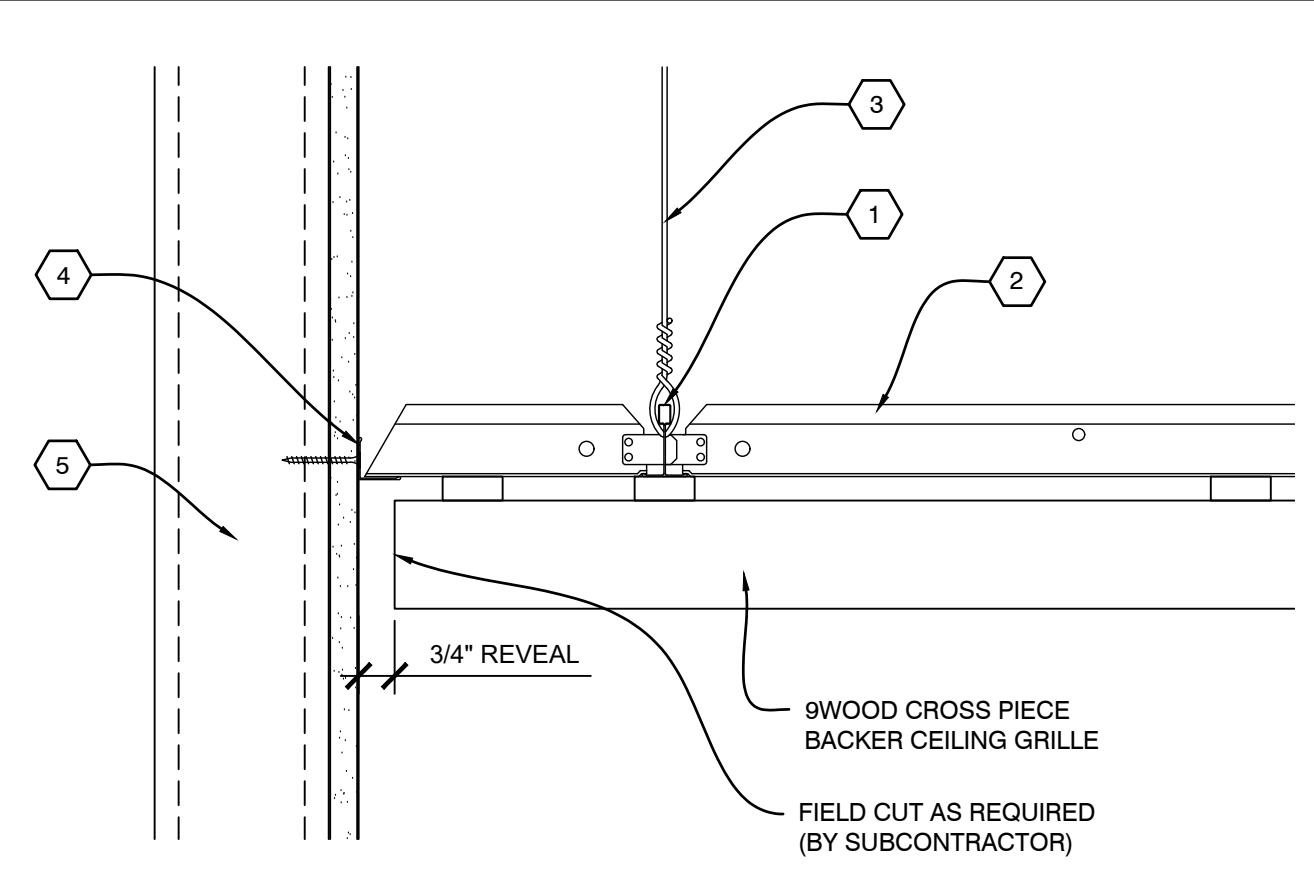

A1 SECTION - PERIMETER
SCALE: 1/4" = 1"

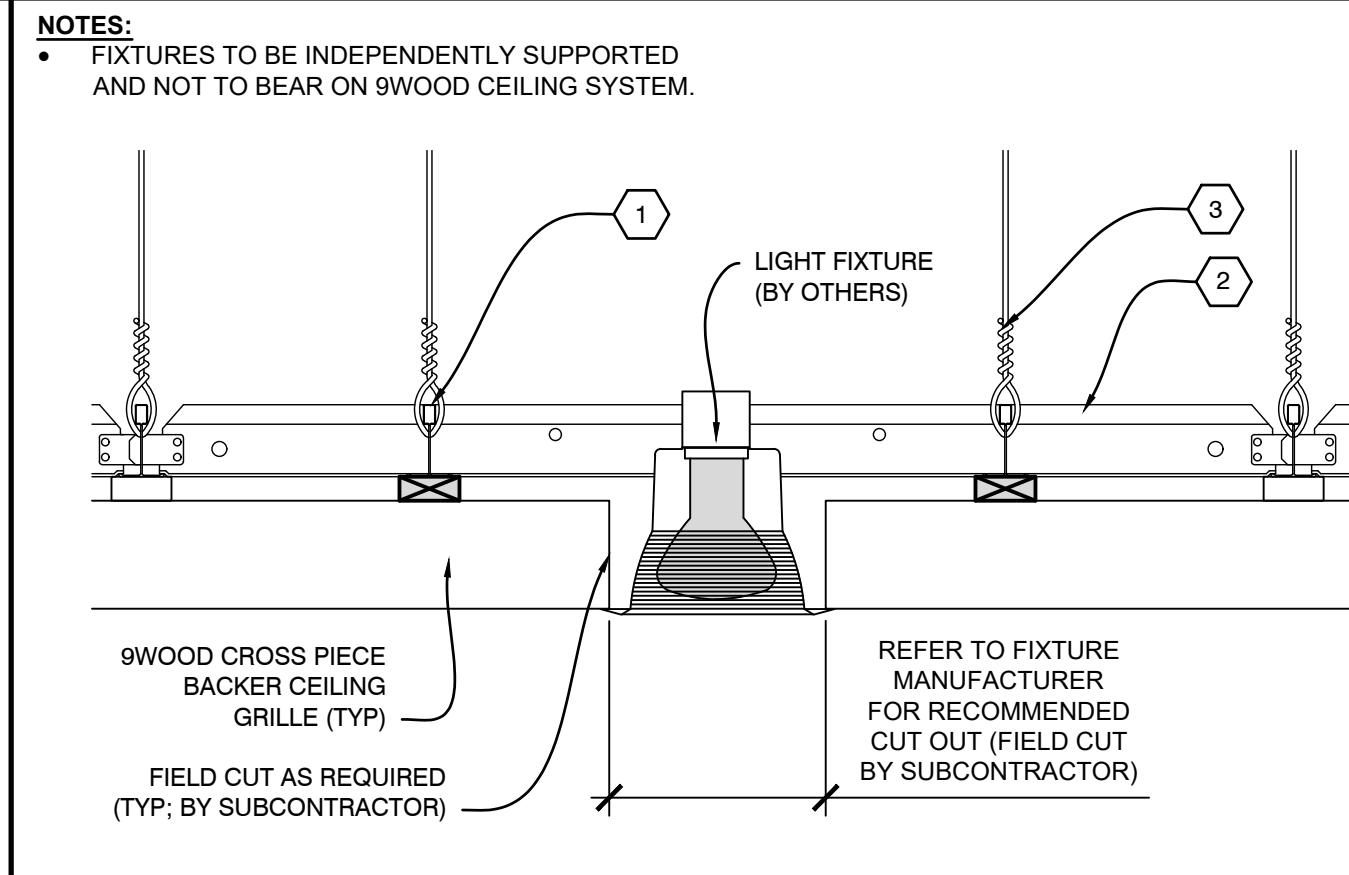

A2 SECTION - LIGHT FIXTURE
SCALE: 1/4" = 1"

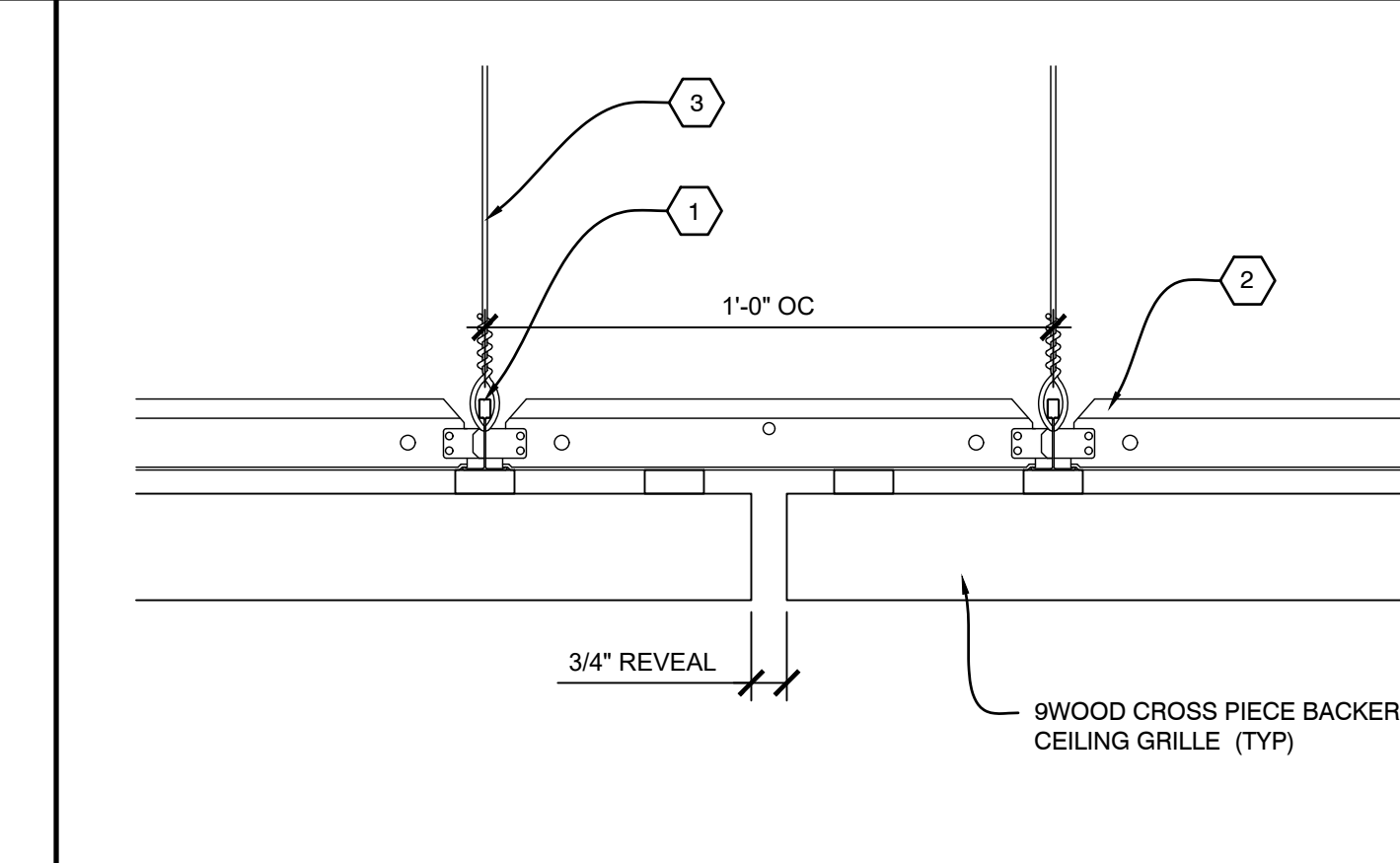

A3 SECTION - ABUTTING REVEAL
SCALE: 1/4" = 1"

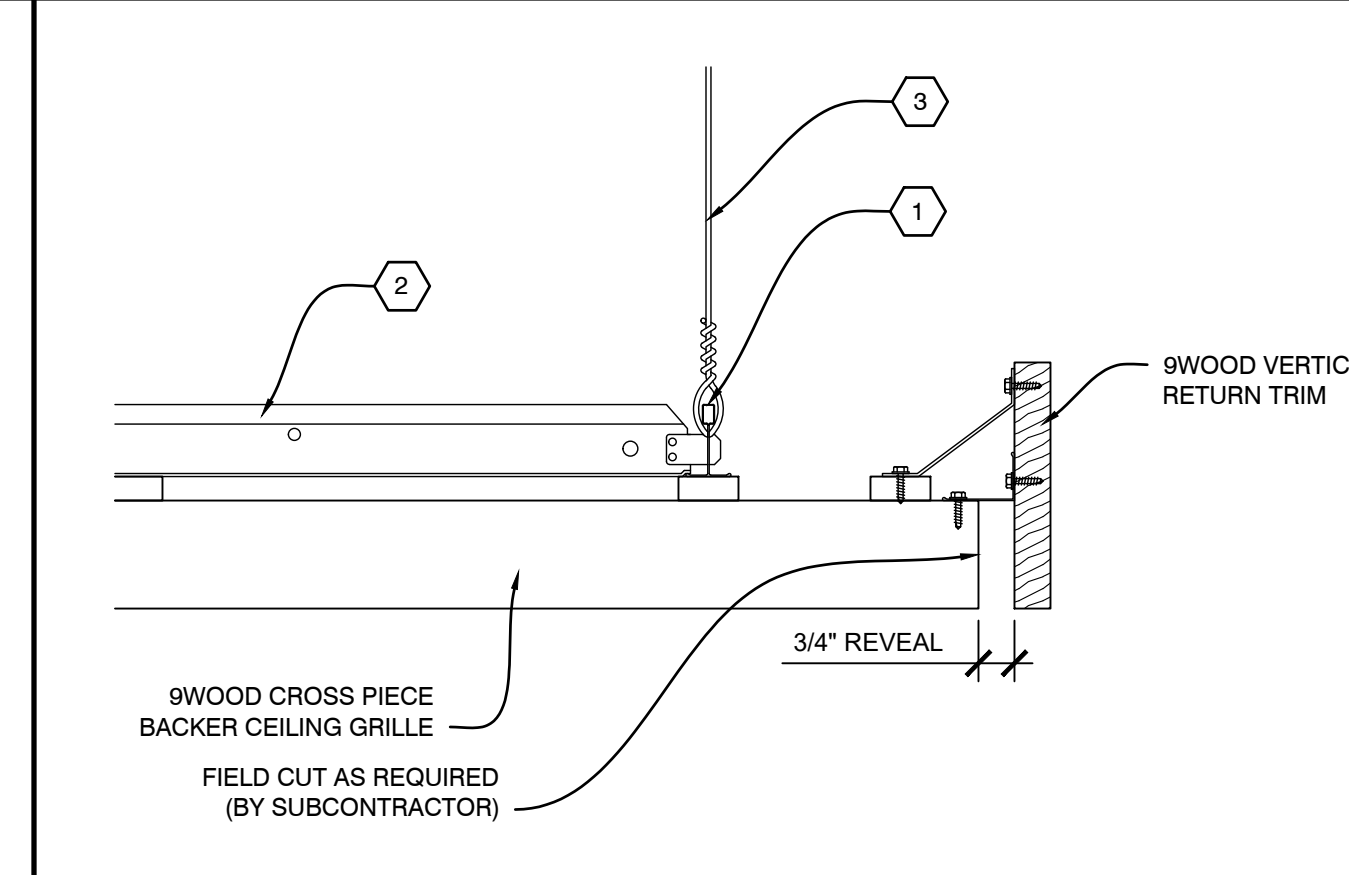

A4 SECTION - PERIMETER
SCALE: 1/4" = 1"

PROJECT

PROJECT NUMBER:
PROPOSAL NUMBER:

REVISION HISTORY

REV#	DATE	DESCRIPTION
10		
9		
8		
7		
6		
5		
4		
3		
2		
1		
0	07.18.25	RELEASE FOR APPROVAL'S

SHEET INFORMATION

DRAWING TYPE: SHOP DRAWINGS
DRAWN BY: RAC & NWC
STANDARDS REVIEW: JBH
TECHNICAL REVIEW: JBH

THIS DOCUMENT CONTAINS PROPRIETARY INFORMATION OF 9WOOD, INC. COPYRIGHT © 2015 9WOOD, INC. ALL RIGHTS RESERVED.

KEY NOTES

- 1 15/16" HEAVY DUTY T-BAR MAINRUNNER (TYP; BY SUBCONTRACTOR)
- 2 15/16" T-BAR CROSSTEE (TYP; BY SUBCONTRACTOR)
- 3 HANGER WIRE (TYP; BY SUBCONTRACTOR)
- 4 WALL ANGLE AND APPROPRIATE INSTALLATION FASTENER (TYP; BY SUBCONTRACTOR)
- 5 PERIMETER CONDITION (TYP; BY OTHERS)

SHEET TITLE

SYSTEM DETAILS

9WOOD, INC. 15/16" HEAVY DUTY T-BAR MAINRUNNER (TYP; BY SUBCONTRACTOR) 15/16" T-BAR CROSSTEE (TYP; BY SUBCONTRACTOR) HANGER WIRE (TYP; BY SUBCONTRACTOR) WALL ANGLE AND APPROPRIATE INSTALLATION FASTENER (TYP; BY SUBCONTRACTOR) PERIMETER CONDITION (TYP; BY OTHERS)