

LIGHT-CURING EQUIPMENT SELECTOR GUIDE



Only Dymax offers expert knowledge of light-cure technology, along with a full array of light-cure products. Dymax is committed to developing a true collaborative partnership — applying our extensive process knowledge to your specific application challenges.

Because we understand the process as a whole, and not just individual aspects of it, we can offer our customers a solution where chemistry and equipment work seamlessly together with maximum efficiency.

Our application engineering team works side-by-side with customers, providing assistance with product and process design, testing, evaluation, and pre-production trials throughout the life of the assembly process.



Dymax Light-Curing Technology

For more than 40 years, light-curing technology has allowed manufacturers to lower processing costs, produce higher quality products, and eliminate the use of harmful chemicals from the workplace. First introduced in the early 1980s for ink and thin coating applications, the technology has advanced tremendously over the last three decades, becoming the method of choice for many other industrial bonding, sealing, coating, potting, and tacking applications.

Light curing's popularity stems from its ability to deliver fast, durable bonds in seconds, on demand. Faster on-demand cures result in more efficient manufacturing processes by providing shorter cycle times, reduced labor costs, and reduced work-in-progress. In addition to its efficiency, light-curing technology is also environmentally and worker friendly. It utilizes no explosive equipment, is associated with fewer health issues, and requires lower regulatory and disposal costs than other technologies.

Dymax has specialized in light-curing assembly solutions since the introduction of the technology. Today, we offer the broadest range of light-curable materials available and a complete line of conventional and LED light-curing equipment. Our light-curing equipment offers manufacturers safe, reliable curing in a number of different configurations including spot, flood, and conveyor systems.

About This Guide

This selector guide provides an overview of Dymax light-curing systems. Additional information for all systems is available on our website at dymax.com. For answers to your specific application questions, please contact our Application Engineering team. They are available to help recommend a light-curable material and design a dispensing and curing process for your specific application. Whenever possible, our Application Engineers will also conduct testing on your specific parts to ensure the chosen products meet all application requirements. If testing indicates our standard formulations or light-curing systems are not suitable, our Application Engineers can also help you find an alternative solution for your assembly process.

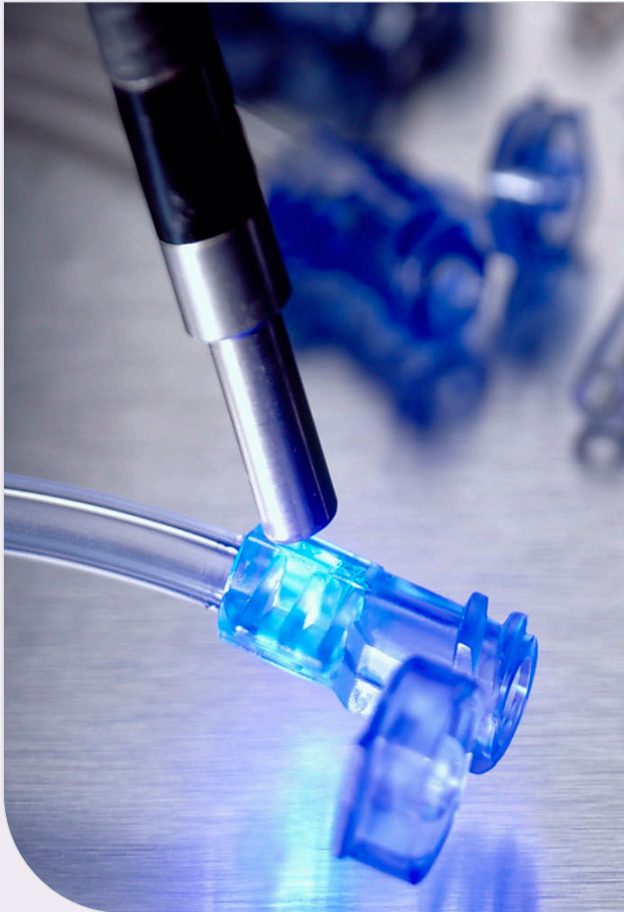

UV Broad-Spectrum & LED Spot-Curing Systems

Spot-cure systems deliver optimized curing energy to a very precise location. They can be used manually by an operator in a turnkey bench-top system or incorporated into a high-speed automated assembly line. They are ideal for curing small areas quickly in R&D laboratory environments as well as low- and high-volume production applications in the medical, industrial, electronics, automotive, and optical industries.

Dymax spot systems are worker friendly, utilizing an integral timed/manual closure control and typically requiring little external shielding. Dymax systems also feature a patented intensity adjustment feature which aids users in both validating and controlling the light-curing process. Dymax spot systems are designed with either arc lamp or LED energy sources.

Conventional Arc Lamp Spot-Curing Systems

Dymax multi-spectrum spot lamps cure using high-pressure metal-halide lamps that produce light energy in the 300 to 450 nm range. These spot lamps can be equipped with rod lenses or single- or multiple-pole lightguides in various diameters (3, 5, and 8 mm) and lengths (up to 3 meters) for a variety of curing options.

LED Spot-Curing Systems

Dymax LED spot-curing systems generate curing energy using an array of surface-mounted LEDs instead of traditional metal halide or mercury bulbs. They are semiconductor energy sources that emit very discrete wavelengths of energy, resulting in a single, narrow, bell-shaped emission spectrum.

These units offer cooler cures compared to traditional lamp-style curing systems as well as longer service life that eliminates lamp replacement and reduces maintenance costs, higher electrical efficiency and instant on/off capability that lowers operating costs, and "green" attributes that eliminate mercury and ozone safety risks and handling costs.

BlueWave® 200 Version 3.1

The BlueWave® 200 3.1 is a high-intensity, light-curing spot-lamp system. This spot-curing lamp emits energy in the UVA and visible portion of the spectrum (300-450 nm) for light curing of adhesives, coatings, and encapsulants. Ideally suited for either manual or automated processes, the unit contains an integral shutter which can be actuated by a foot pedal or PLC and a universal power input (100-240 V, 50-60 Hz) that provides consistent performance at any voltage. A wide range of lightguides in various materials and configurations are available for use with this unit, providing application flexibility.

The BlueWave® 200's faceplate design features an improved operator interface with an easy-to-read LCD display. Also located on the faceplate is the unit's patented intensity adjustment control. This feature is important for validating an appropriate intensity range and maintaining that range during production. Users can manually adjust the unit's intensity to accommodate for bulb degradation and other factors that may affect intensity.

- Manual intensity adjustment, >17,000 mW/cm² initial intensity
- Large, easy-to-read front panel LCD display
- Improved user interface for easier operation
- Extended exposure time settings to 9,999.9 seconds
- Controlled power-up sequence ensures proper temperature

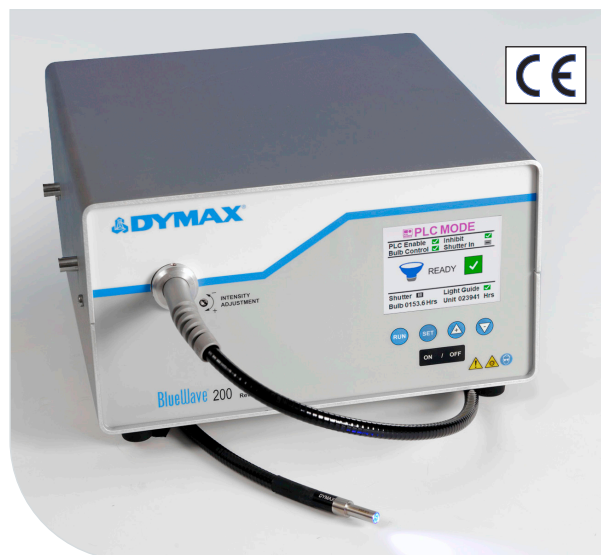

| | |
|---------------------------|--|
| BlueWave® 200 Version 3.1 | 41014 Type G Plug 41014 Unit with No Power Cord |
|---------------------------|--|

BlueWave® MX-150

This curing system provides manufacturers with the curing flexibility they need, in a smaller, more efficient design. The unit is comprised of two main parts, a controller with an easy-to-use touchscreen interface and a high-intensity LED emitter which is uniquely designed to offer higher, more consistent curing intensity than traditional spot-curing systems. Curing energy is created using an LED chip in the emitter, unlike traditional spot-cure systems, where it is located in the controller. Locating the LED chip at the point-of-cure provides more consistent curing by addressing potential intensity loss caused by the use of long or bent lightguides.

With this new design, the system can be truly tailored to users' curing needs – allowing them to choose from three different wavelength LED emitters (365, 385, or 405 nm) so optimal cures are achieved. Users also have endless set up flexibility; for automated curing processes, the emitter can be easily mounted to robotic arms or further from the controller without fear of intensity variations. When used as a bench-top curing system, the unit can be paired with a stand and shielding or a Wolf-style lightguide can be connected to the system for specialized applications.



- High intensity of up to 40 W/cm² for faster curing
- Touchscreen interface for easier operation
- Emitter design for set up flexibility and consistent intensity
- LED emitters in 365, 385, and 405 nm wavelengths
- Admin and production modes with the ability to save curing programs for repeated use
- Instant on/off for a more energy efficient unit with no warm-up period
- PLC interface that is easily incorporated into automated systems

A complete BlueWave® MX-150 system features a controller and an LED emitter. Components are sold separately. Wolf-style lightguides and other accessories can be added for specific applications. See pages 7 and 8 for additional accessories.

| | PrimeCure® 385 nm | VisiCure® 405 nm | RediCure® 365 nm |
|---|---|------------------|------------------|
| LED Emitter* | 42337 | 42338 | 42336 |
| BlueWave® MX-Series 2-Channel Controller Only | 43184 Unit with No Power Cord 43186 Type G Plug | | |
| BlueWave® MX-Series 4-Channel Controller Only | 43181 Unit with No Power Cord 43183 Type G Plug | | |
| BlueWave® MX-MIM | 43299 Machine Interface Module Only | | |
| Accessories | 36987 5-mm Lightguide Simulator 41148 Adjustable Taper Shoulder Focusing Lens (5 mm) | | |
| Interconnect Cables | 43453 Interconnect Cable Assembly (12 inches) 42287 Interconnect Cable Assembly (2 meter) 42889 Interconnect Cable Assembly (5 meter) 43010 Interconnect Cable Assembly (10 meter) 43011 Interconnect Cable Assembly (20 meter) | | |

* Note: 5-mm lightguide simulator comes with every emitter

BlueWave® QX4 V2.0

The BlueWave® QX4 V2.0 high-intensity spot-curing system features all the benefits of LED-curing technology in a smaller, more versatile unit. This system is comprised of a controller and up to four LED heads. LED heads are available in 365, 385, and 405 nm and can be outfitted with 3-, 5-, or 8-mm diameter focusing lenses. LED heads and focusing lenses can be used in any combination and can be controlled through the system's variable mode, a feature that allows each head to be individually programmed for intensity and cycle times. Individual exposure times and intensity settings can be set in 1% increments for each LED head, giving users maximum curing flexibility.

In addition to its curing flexibility, the system also features an easy-to-use control interface that allows flexibility in setup and use of the unit. The unit can be activated by touchscreen, foot pedal, or through an I/O interface connection, allowing it to be easily incorporated into automated systems.



- One controller controls up to four LED heads, which can be programmed independently
- LED heads in 365, 385, or 405 nm wavelengths
- Interchangeable/replaceable focusing lenses in 3-, 5-, and 8-mm diameters
- Instant on/off for a more energy efficient unit with no warm-up period
- Efficient LED-head temperature management
- PLC interface that is easily incorporated into automated systems

A complete BlueWave® QX4 V2.0 system features a controller and up to four LED heads/lenses. Each LED head must have a lens in order to operate properly. Components are sold separately.

| | RediCure® 365 nm | PrimeCure® 385 nm | VisiCure® 405 nm |
|------------------|---|-------------------|------------------|
| LED Head | 88807 | 88808 | 88809 |
| Controller Only | 88828 with No Power Cord* 88823 with China Power Cord (Type I) 88824 with North American Power Cord (Type B) 88825 with EU Power Cord (Type F) 88826 with UK/Asia Power Cord (Type G) | | |
| Lens Only | 82105 3-mm Lens 82106 5-mm Lens 82107 8-mm Lens | | |
| Cable Extensions | 84125 1.0 M Extension 84127 2.0 M Extension | | |
| Accessories | 88821 Mounting Clamp Kit 88822 Connection Clamp 81208 Mounting Clamp Extension Kit | | |

*The appropriate power cord is included for orders in Europe.

Lightguides

Lightguides transmit UV and visible energy from a source mounted inside of a spot-curing unit to the curing area. When choosing a lightguide for your system, the following factors should be considered:

Length – Lightguides are commonly one meter long although other lengths are available.

Diameter – Single-pole lightguides are available with 3-mm, 5-mm, or 8-mm inside diameters. Although the 5-mm lightguide will register a higher intensity, the 8-mm lightguide provides more curing power (intensity x area) because a larger lightguide opening captures more of the light emitted from the bulb. Each pole of a multi-pole lightguide has an inside diameter of 3 mm.

Multiple Poles – Light emitting from a spot lamp can be channeled through a single lightguide (single pole) or split between multiple lightguides (multiple poles). Each pole of a multi-pole lightguide emits equal intensity (typically $\pm 10\%$ for liquid-filled lightguides) and all share a common shutter. Both liquid-filled and quartz-fiber multi-pole lightguides are available from Dymax.

Connection – There are basically two types of connectors used in the spot lamp industry, “Wolf” and “D” connectors. Dymax provides lightguides with both connector types, although “D” connectors are an industry standard and compatible with current Dymax lamp designs (older Dymax designs utilized “Wolf” connectors).

Curing Area/Intensity vs. Distance – The UV and visible light emitted from a lightguide diverges. As a result, intensity decreases and curing area increases with distance from the end of the light guide. The chart to the right describes this relationship clearly for the 5-mm liquid lightguide.

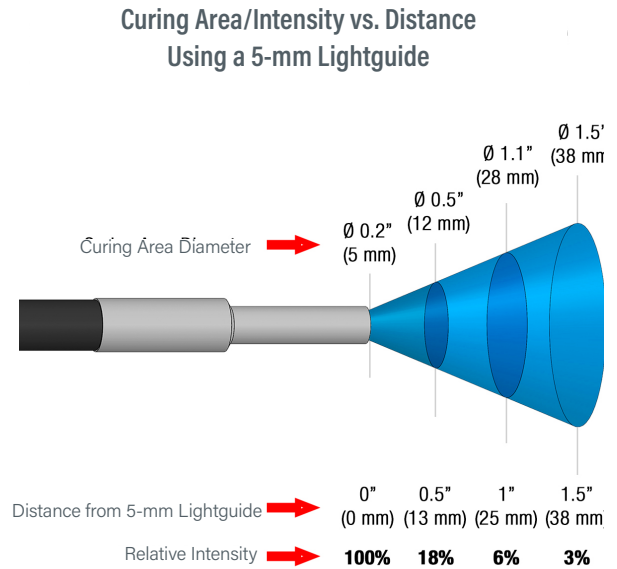

| Part Number | Lightguide Description (all noted are liquid filled; quartz fiber are also available) | Compatible Dymax Systems |
|-------------|--|---|
| 5720 | Single Pole 5 mm x 1 M | BlueWave® 75 BlueWave® 200 BlueWave® LED Prime UVA BlueWave® LED VisiCure® BlueWave® DX-1000 BlueWave® DX-1000 VisiCure® |
| 5721 | Single Pole 5 mm x 1.5 M | |
| 5722 | Single Pole 8 mm x 1 M | |
| 38476 | Two Pole 3 mm x 1 M | |
| 38477 | Three Pole 3 mm x 1 M | |
| 38478* | Four Pole 3 mm x 1 M | Compatible with All BlueWave® Spot Lamps |
| 36619 | Single Pole - Wolf Style 3 mm x 1 M | BlueWave® MX-150 |
| 37043 | Two Pole - Wolf Style 3 mm x 1 M | |
| 35101 | Single Pole - Wolf Style 5 mm x 0.5 M | |
| 35102 | Single Pole - Wolf Style 5 mm x 1 M | |
| 36238 | Single Pole - Wolf Style 5 mm x 1.5 M | |
| 38998 | Single Pole - Wolf Style 5 mm x 2 M | |
| 38676* | Four Pole - Extended Range 3 mm x 1 M | |
| 38851* | Four Pole 3 mm x 1.5 M | |
| 39791* | Four Pole - Fiber Optic 3 mm x 1 M | |

*Lightguide adapter conversion kit (PN 42932) required for use with BlueWave® MX-150.

Accessories

Lightguide Mounting Stands

39700 Single Lightguide Mounting Stand

Utilizes a 24" flexible arm for mounting 3, 5, and 8-mm lightguides. This stand offers a 5" x 5" (127 mm x 127 mm) working area and allows repeatable, hands-free spot curing.

41325 Acrylic Lightguide Mounting Stand

Multiple lightguides can be securely mounted on this stand for repeatable, hand-free spot curing.

41595 Lightguide Stand Expansion Kit

Allows the Dymax acrylic lightguide mounting stand to hold up to four lightguide poles.



Single Lightguide Mounting Stand

Rod Lenses

Turn a spot into a flood lamp with shutter! A rod lens re-focuses the UV light emitted from a spot lamp to create a very uniform (<5% variation) 2" x 2" (50.8 mm x 50.8 mm) or 5" x 5" (127 mm x 127 mm) curing area. These rod lenses attach to the UV light-curing spot system using an 8-mm lightguide (sold separately).

38699 Rod Lens, 2" x 2" (50.8 mm x 50.8 mm) Area

38698 Rod Lens, 5" x 5" (127 mm x 127 mm) Area

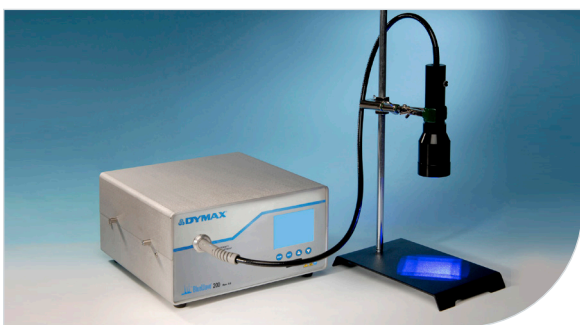

BlueWave® 200 with Rod Lens

Lightguide Terminators

Lightguide terminators can be attached to the end of a lightguide to help users get UV light to those difficult-to-reach locations.

39029 3 mm/60°

39030 3 mm/90°

38042 5 mm/60°

38049 5 mm/90°

39334 8 mm/60°

39333 8 mm/90°



Lightguide Simulators

A lightguide simulator can be used to accurately measure the direct light intensity from the system's energy source.

38408 Lightguide Simulator, 7-mm Diameter

36987 Lightguide Simulator, 5-mm Diameter

Emitter Stands & Shields

42390 BlueWave® MX-Series Mounting Stand

Mounting stand with adjustable height for a single MX-series emitter.

43019 BlueWave® MX-Series Single Emitter Mounting Kit

Mounting adapter for attaching MX-series emitters.

43070 BlueWave® MX-Series Multi-Array Mounting Stand

Accommodates up to 4 MX-series emitters.

42426 Single Emitter Mount for MX Controller

Securely mount one emitter to the side of the MX controller for configurations using a lightguide.

60868 Dual Emitter Mount for MX Controller

Securely mount up to two emitters to the side of the MX controller.

41395 Three-Sided Acrylic Shield

Compatible with the BlueWave® MX-150. A simple and cost effective three-sided shield that is removed manually.



UV Broad-Spectrum & LED Flood-Curing Systems

Flood-style curing systems usually provide moderate to high-intensity light. These units have the advantage of being able to cure a tray of parts, or parts with large bonded or coated areas. These kinds of lamps are commonly integrated into existing manufacturing processes by mounting them above high-speed assembly lines. Fairly deep cures can be achieved by these relatively inexpensive units at 10- to 30-second exposure times. Wide-area flood lamps are used successfully to cure substrates that are somewhat heat-sensitive, such as certain plastics.

Dymax currently offers both broad-spectrum and LED flood curing systems to fit a wide variety of curing applications. Shutter assemblies, mounting stands, shields, and other accessories are available to order to create custom bench-top curing systems. CE marked units are available for manufacturers in Europe.

Broad-Spectrum Flood Lamps

Dymax broad-spectrum flood curing systems use moderate- to high-intensity (105-225 mW/cm²) UV/visible light to cure UV light-curable adhesives, coatings, and inks in as little as 5-30 seconds. Systems are available with 5" x 5" (127 mm x 127 mm) or 8" x 8" (203 mm x 203 mm) curing areas. They come standard with a 400 watt metal-halide bulb but can be outfitted with longwave, shortwave, UV, and visible replacement bulbs to fit unique applications. All bulbs have a long service life and come with a 2,000 hour warranty.

LED Flood Curing Systems

Dymax LED flood lamp systems use high-intensity LEDs to cure a 5" x 5" (12.7 cm x 12.7 cm) area. Because these flood systems use a high-intensity LED as the curing source they produce faster cure times, more consistent frequency and intensity output, a cooler curing environment for thermally sensitive substrates, and longer bulb life than conventional arc lamps. Systems are available in three different wavelength arrays (365, 385, and 405 nm) so users can fully optimize the curing process between their light-curable material and the curing system. costs, and "green" attributes that eliminate mercury and ozone safety risks and handling costs.

EC-Series Flood Lamp Systems

EC-series flood-lamp systems are ideal for light curing large parts or curing many small parts simultaneously. With intensities ranging from 105-225 mW/cm², Dymax flood lamps are capable of curing most UV light-curable adhesives, sealants, and coatings, tack free in 30 seconds or less. These flood lamps can be incorporated into automated assembly systems or mounted onto conveyors. Dymax flood units can also be used as turnkey bench-top units (with optional shutters).

- Large curing area, 5" x 5" (12.7 cm) or 8" x 8" (20.3 cm)
- Adjustable lamp height
- 100% shielding with safety interlock kit
- Two bulb options: shortwave or longwave

| | 1200-EC | 2000-EC | 5000-EC |
|--|----------------------------|-----------------------------|-----------------------------|
| Typical Intensity Output, mW/cm ² * | 350 | 105 | 225 |
| Curing Area | 1" x 6" (2.5 x 15.2 cm) | 8" x 8" (20.3 x 20.3 cm) | 5" x 5" (12.7 x 12.7 cm) |
| Working Distance | 2"-6" (5.08 cm - 15.24 cm) | | |
| Typical Degradation | <20% over 2,000 hours | | |
| Power Requirements | 90-264V, 47-63 Hz | | |

* Measured with a Dymax ACCU-CAL™ 50 Radiometer (320-395 nm) at a lamp height of 3" using a standard metal halide bulb.



5000-EC Shown with ZIP™ Shutter & Light Shield

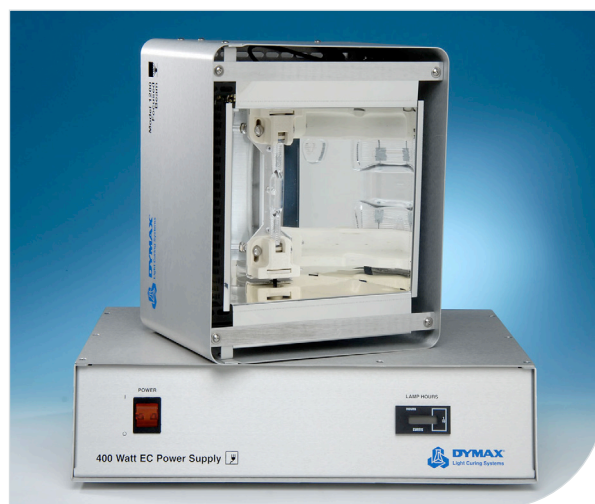

Modular 2000-EC Flood

| System Options** | 1200-EC | 2000-EC | 5000-EC |
|---------------------------------------|---------|---------|---------|
| Modular (No Shielding or Shutter) | 38110 | 38105 | 38100 |
| With Mounting Stand | 39930 | 39730 | 39830 |
| With EC Light Shield | 39920 | 39720 | 39820 |
| With EC Light Shield & Manual Shutter | - | 39723 | 39823 |
| With EC Light Shield & ZIP™ Shutter | - | 39721 | 39821 |

**All part numbers include a North American power cord (120V plug)

ECE-Series Flood Lamp Systems

Dymax UV light-curing flood-lamp systems are ideal for light curing large parts or curing many small parts simultaneously. With intensities ranging from 105-225 mW/cm², Dymax flood lamps are capable of curing most UV light-curable adhesives, sealants, and coatings, tack free in 30 seconds or less. These flood lamps can be incorporated into automated assembly systems or mounted onto conveyors. Dymax flood units can also be used as turnkey bench-top units (with optional shutters).

- Large curing area, 5" x 5" (12.7 cm) or 8" x 8" (20.3 cm)
- Adjustable lamp height
- 100% shielding with safety interlock kit
- Two bulb options: shortwave or longwave
- Extended exposure time settings to 9,999.9 seconds
- Controlled power-up sequence ensures proper temperature

| | ECE 2000 | ECE 5000 |
|---------------------------|--|--------------------------------|
| Typical Intensity Output* | 105 mW/cm ² | 225 mW/cm ² |
| Curing Area | 8" x 8" (20.3 cm x 20.3 cm) | 5" x 5" (12.7 cm x 12.7 cm) |
| Working Distance | 2"-6" (5.08 cm - 15.24 cm) | |
| Typical Degradation | <20% over 2,000 hours | |
| Power Requirements | 100-240 VAC, +/- Single Phase 50-60 Hz | |

* Intensity readings vary widely depending on the make and model of the radiometer. These intensities were measured with the ACCU-CAL™ 50 radiometer.



ECE 5000 Shown with ZIP™ Shutter & Light Shield



Modular ECE 5000

| | ECE 2000 (8" x 8" (20.3 cm x 20.3 cm)) | ECE 5000 (5" x 5" (12.7cm x 12.7cm)) |
|---|--|--|
| Modular (No Shielding or Shutter) | 40995 Type G Plug 40965 No Power Cord | 40935 Type G Plug 40915 No Power Cord |
| With Mounting Stand | 41180 Type G Plug 40920 No Power Cord | 41140 Type G Plug 40970 No Power Cord |
| With ECE Light Shield | 41200 Type G Plug 40870 No Power Cord | 41160 Type G Plug 40900 No Power Cord |
| With ECE Light Shield & Manual Shutter | 40860 Type G Plug 40790 No Power Cord | 41100 Type G Plug 40850 No Power Cord |
| With ECE Light Shield & ECE ZIP™ Shutter | 41060 Type G Plug 40830 No Power Cord | 41050 Type G Plug 40840 No Power Cord |

BlueWave® AX-550 V2.0

The BlueWave® AX-550 combines a controller, emitter, and power supply into a compact, all-in-one LED flood-curing system. Eliminating the need for a large, traditional-style controller and bulky cables, this unit has a greatly reduced footprint and is easily integrated into automated processes.

The system features a large 5" x 5" (12.5 x 12.5 cm) curing area, which is controlled by an easy-to-navigate user interface with push-button controls or through a PLC interface. Dymax offers the system with three different wavelength emitters (365, 385, and 405 nm), which are field-upgradable by customers so they can switch to another wavelength easily if needed.

| | RediCure® 365 nm | PrimeCure® 385 nm | VisiCure® 405 nm |
|--|--|----------------------|---------------------|
| Typical Intensity Output, mW/cm ² * | 650 | 800 | 800 |
| Dimensions (H X W X D) | 6.54" x 11.41" x 6.75" (166 mm x 290 mm x 171 mm) | | |
| Curing Area | 5" x 5" (12.5 cm x 12.5 cm) | | |
| Power Requirements | 100 - 240 VAC 50/60 Hz (Auto-Ranging) | | |

* When measured at 25-mm distance with an ACCU-CAL™ 50-LED radiometer in flood mode.

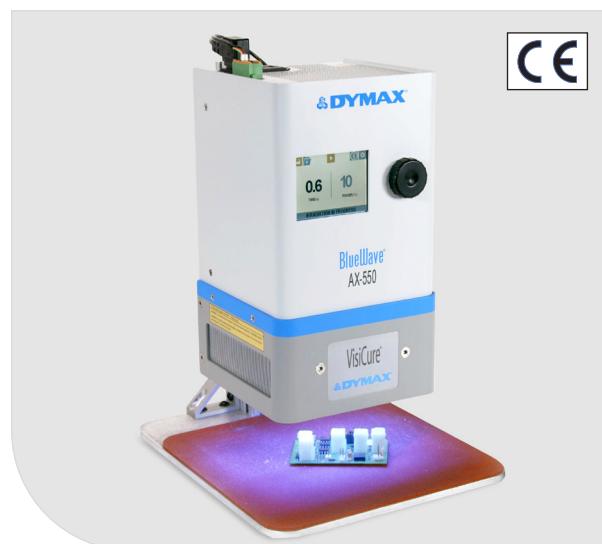

- Large curing area, 5" x 5" (12.5 cm) active area
- All-in-one design for small footprint and no bulky cables
- User interface with touchscreen and rotary push button control
- Emitters available in 365, 385, and 405 nm wavelengths
- Unit can be used as a bench-top cure system or incorporated into an automated process or conveyor
- Direct-to-frame pre-drilled holes for stability and easy mounting and integration into automated systems
- PLC interface that allows for control and monitoring of power levels, exposure times/routines, and system health and safety lockout

| | RediCure® (365 nm) | PrimeCure® (385 nm) | VisiCure® (405 nm) |
|-------------------------|--------------------|---------------------|--------------------|
| Unit with Type G Plug | 60876 | 60879 | 60882 |
| Unit Without Power Cord | 60877 | 60880 | 60883 |

BlueWave® FX-1250

The BlueWave® FX-1250 is a high intensity flood-curing system that delivers true, high-irradiance LED light for better speed, depth, and fullness of cure. The system provides the best cure by combining intensities of over 2 W/cm² with a 5" x 5" (12.7 cm x 12.7 cm) curing area and high uniformity.

The BlueWave® FX-1250 is comprised of a controller and up to two LED emitters. The controller features a 7" touch screen with an intuitive, easy to use interface. It can be activated, controlled, and remotely monitored by PLC, and also store programs and parameters for repeatable processes. The controller also continuously monitors the health of the system. LED emitters are available in three wavelengths for greater curing flexibility.

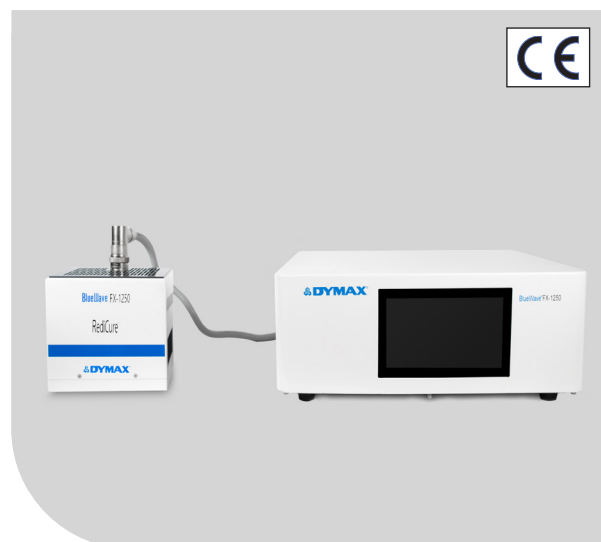

| | RediCure® 365 nm | PrimeCure® 385 nm | VisiCure® 405 nm |
|---|--|----------------------|---------------------|
| Typical Intensity Output, mW/cm²* | 1700 | 2100 | 2000 |
| Dimensions (W X H X L) | Emitter: 6.7" x 5.3" x 6.4" (170 mm x 134 mm x 162 mm) 1CH Controller: 4.5" x 13" x 18.25" (11.4 cm x 33.0 mm x 46.4 cm) 2CH Controller: 16.5" x 13.8" x 5.8" (420 mm x 350 mm x 165 mm) | | |
| Curing Area | 5" x 5" (12.7 cm x 12.7 cm) | | |
| Power Requirements | 100-240 V≈ 10 Amps, 50-60 Hz | | |

* When measured at 25-mm distance with an ACCU-CAL™ 50-LED radiometer in flood mode.

- Large curing area, 5" x 5" (12.7 cm x 12.7 cm)
- Excellent uniformity and higher intensity
- LED emitters available in 365, 385, and 405 nm wavelengths
- 7" Touch screen interface
- 1 & 2 Channel Controller Options
- PLC activation and control
- Greener technology - no ozone generation, mercury free, & lower energy consumption than conventional lamps
- Fully programmable with capability to store up to 16 programs
- Unit can be used as a bench-top cure system or incorporated into an automated process or conveyor

The BlueWave® FX-1250 is sold as a complete system or as separate components. Other accessories can be added for specific applications. See page 15 for additional accessories.

| | RediCure® (365 nm) | PrimeCure® (385 nm) | VisiCure® (405 nm) |
|---|---|--|--|
| LED Emitter | 88801 | 88802 | 88803 |
| BlueWave® FX-1250 1-Channel Controller Only | 88850 with No Power Cord* 88805 with China Power Cord 88846 with North American Power Cord | | |
| BlueWave® FX-1250 2-Channel Controller Only | 88851 with No Power Cord* 88804 with China Power Cord 88847 with North American Power Cord | | |
| Complete System (1CH Controller, Interconnect Cable, 1X Emitter, Foot Switch, Power Cord) | 88856 with No Power Cord* 88859 with China Power Cord 88848 with N. American Power Cord | 88857 with No Power Cord* 88860 with China Power Cord 88849 with N. American Power Cord | 88858 with No Power Cord* 88861 with China Power Cord 88855 with N. American Power Cord |
| Interconnect Cables | 84025 Type L & L 84026 Type I & L | | |

No Power Cord*
China Power Cord
North American Power Cord
Europe Power Cord

The appropriate power cord is included for orders in Europe.
Type I
Type B
Type F

BlueWave® MX-250

The BlueWave® MX-250 is comprised of two main parts, a controller with an easy-to-use touchscreen interface and a uniquely designed, high-intensity LED emitter. Curing energy is created using a micro-processor-controlled LED chip set in the emitter. The emitter provides a curing area of 50 mm x 50 mm but multiple systems can be grouped together to create larger curing pattern matrixes as needed.

This system's design allows it to be truly tailored to users' curing needs – allowing them to choose from three different wavelength LED emitters (365, 385, or 405 nm) and providing additional flexibility with the size and pattern of the active curing area. Users also have endless set up flexibility, as this system can be set up as a bench-top unit, or for automated curing processes, the emitter can be easily mounted to robotic arms or further from the controller without fear of intensity losses.

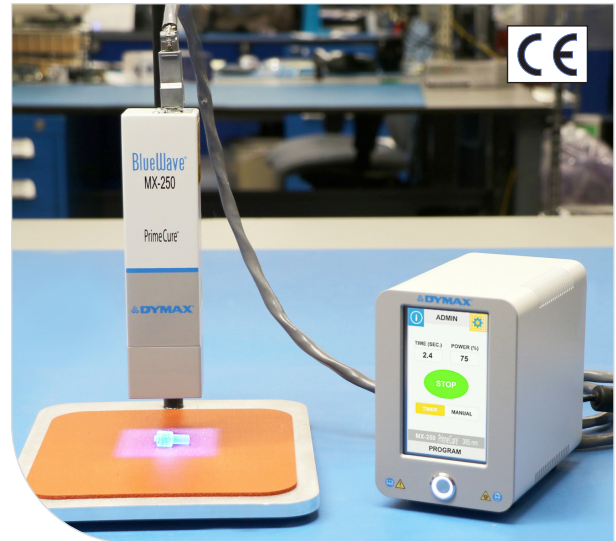

- 1.97" x 1.97" (50 mm x 50 mm) curing area with the option for multiple systems to be grouped together to create larger curing patterns
- Touchscreen interface for easier operation
- Emitter design for set up flexibility and consistent intensity
- LED emitters in 365, 385, and 405 nm wavelengths
- Admin and production modes with the ability to save curing programs for repeated use
- Instant on/off for a more energy efficient unit with no warm-up period
- PLC interface that is easily incorporated into automated systems

| | RediCure® 365 nm | PrimeCure® 385 nm | VisiCure® 405 nm |
|--|--------------------------------|----------------------|---------------------|
| Typical Intensity Output, mW/cm ² * | 255 | 355 | 375 |
| Curing Area | 1.97" x 1.97" (50 mm x 50 mm) | | |
| Power Requirements | 100 - 240 VAC ≈ 2.5 A, 50-60Hz | | |

* Measured at 25-mm distance with an ACCU-CAL™ 50-LED radiometer.

A complete BlueWave® MX-250 system features a controller and an LED emitter. Components are sold separately. Other accessories can be added for specific applications. See page 15 for additional accessories.

| | RediCure® (365 nm) | PrimeCure® (385 nm) | VisiCure® (405 nm) |
|---|---|---------------------|--------------------|
| LED Emitter | 42806 | 42807 | 42808 |
| BlueWave® MX-Series 2-Channel Controller Only | 43184 Unit with No Power Cord 43186 Type G Plug | | |
| BlueWave® MX-Series 4-Channel Controller Only | 43181 Unit with No Power Cord 43183 Type G Plug | | |
| BlueWave® MX-MIM | 43299 Machine Interface Module Only | | |
| Interconnect Cables | 43453 Interconnect Cable Assembly (12 inches) 42287 Interconnect Cable Assembly (2 meter) 42889 Interconnect Cable Assembly (5 meter) 43010 Interconnect Cable Assembly (10 meter) 43011 Interconnect Cable Assembly (20 meter) | | |

BlueWave® MX-275

The BlueWave® MX-275 curing system is a high-intensity LED flood-curing system. Light energy is delivered in a line pattern instead of the traditional rectangular pattern. A single BlueWave® MX-275 emitter provides a 5 mm x 50 mm curing area, but when paired with a multichannel controller, up to four emitters can be used to produce a curing area as large as 5 mm x 200 mm.

BlueWave® MX-275 system emitters are available in three different wavelengths: 365, 385 and 405 nm. Emitters can be set up as a bench-top unit, on an array stand to create extended line patterns, or installed on automated curing processing equipment for maximum flexibility.

| | RediCure® 365 nm | PrimeCure® 385 nm | VisiCure® 405 nm |
|--|--------------------------------|----------------------|---------------------|
| Typical Intensity Output, mW/cm ² * | 1,460 | 1,870 | 1,750 |
| Curing Area | 0.20" x 1.97" (5 mm x 50 mm) | | |
| Power Requirements | 100 - 240 VAC ≈ 2.5 A, 50-60Hz | | |

* Measured at a working distance of 10 mm using a Dymax ACCU-CAL™ 50-LED Radiometer with 3-mm aperture set to corresponding light measurement mode. This is preliminary intensity data for reference, tests using flood mode without an aperture will yield different results.



- Delivers high-intensity light energy in a line pattern
- 5 mm x 50 mm cure area can be scaled up by placing emitters side-by-side to provide a large, continuous band of UV LED energy
- Up to 5 mm x 200 mm cure area when paired with 4-channel controller
- Wavelength flexibility allows co-optimization of adhesive and curing system
- Can be set up as bench-top unit, on array stand, or in automated system for maximum flexibility
- Well-suited for conveyor applications where products move under light
-

A complete BlueWave® MX-275 system features a controller and an LED emitter. Each emitter requires an interconnect cable. Components are sold separately.

| | RediCure® (365 nm) | PrimeCure® (385 nm) | VisiCure® (405 nm) |
|--|--|---------------------|--------------------|
| Line Pattern LED Emitters | 43094 | 43098 | 43102 |
| BlueWave® MX-Series 2-Channel Controller Only | 43184 Unit with No Power Cord 43186 Type G Plug | | |
| BlueWave® MX-Series 4-Channel Controller Only | 43181 Unit with No Power Cord 43183 Type G | | |
| BlueWave® MX-MIM | 43299 Machine Interface Module Only | | |
| Interconnect Cables | 43453 Interconnect Cable Assembly (12 inches) 42287 Interconnect Cable Assembly (2 meter) 42889 Interconnect Cable Assembly (5 meter) 43010 Interconnect Cable Assembly (10 meter) 43011 Interconnect Cable Assembly (20 meter) | | |

Accessories

Dymax light-curing flood lamps can be outfitted with the shutters and shielding shown below. Additional shutters, enclosures, and accessories may be available.

Mounting Stands

41268 Standard Mounting Stand

A simple and cost effective mounting stand with adjustable height. Includes an acrylic back shield.

BlueWave® AX-550

43410 BlueWave® AX-550 Mounting Stand

Stand with acrylic back-shield. Includes mounting carriage PN 60036.

60036 BlueWave® AX-550 Mounting Carriage

Mounting carriage to mount the BlueWave® AX-550 on stand PN 41268.

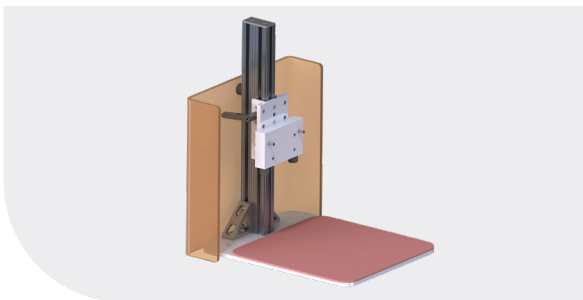

BlueWave® AX-550 Mounting Stand

BlueWave® FX-1250

88844 BlueWave® FX-1250 Mounting Stand

Stand with acrylic back-shield. Includes mounting carriage PN 60036.



BlueWave® FX-1250 Mounting Stand

BlueWave® MX-Series

42909 Single Emitter Mounting Kit

Mounting adapter for attaching MX-series emitters.

42390 Single Emitter Mounting Stand

Mounting stand with adjustable height for a single MX emitter.



Single Emitter Mounting Stand

43019 Multiple Emitter Mounting Kit

Works with stand PN 41268.

43070 Multi-Emitter Stand with Acrylic Back Shield

Mounting stand with acrylic back shield for multiple MX emitters. Works with stand PN 41395.



Multi-Emitter Mounting Stand with Acrylic Back Shield

42426 Single Emitter Mount for MX Controller

Securely mount one emitter to the side of the MX controller.

60868 Dual Emitter Mount for MX Controller

Securely mount up to two emitters to the side of the MX controller.

Shielding

Dymax offers several standard shielding options for flood lamps. All shields are 100% UVA blocking and visibly tinted.

41175 EC Flood Light Shield

360° shielding with lifting door and sliding curing shelf. Compatible with Dymax shutters.

40785 ECE Flood Light Shield

360° shielding with lifting door and sliding curing shelf. Safety Interlock feature included. Compatible with Dymax shutters.

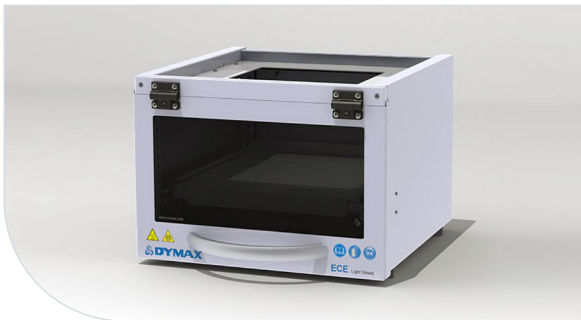

ECE Flood Light Shield

60419 BlueWave® AX-550 Light Shield

360° shielding with a swing-up door and slide-out shelf.

88845 BlueWave® FX-1250 Light Shield

360° shielding with a swing-up door and slide-out shelf. Not compatible with Dymax shutters.

41395 3-Sided Acrylic Shield

A simple and cost effective 3-sided shield that is removed manually. Compatible with BlueWave® MX-250 systems.



3-Sided Acrylic Shield

81016 3-Sided Acrylic Shield

A simple and cost effective 3-sided shield that is removed manually. Compatible with the BlueWave® FX-1250.

Shutters

Turning a bulb off and on between cycles is not practical since each off/on cycle shortens bulb life and requires a 5-minute warm-up period. A shutter, however, can be used to shield a flood system between cycles. Shutters control exposure time, reduce heat on the work surface, and shield operators from exposure to UV light. Dymax carries two types of shutters, ZIP™ and manual.

37863 ZIP™ Shutter (EC Floods)

Timed and manual modes. Foot pedal or PLC controlled.

40885 ZIP™ Shutter (ECE Floods)

Timed and manual modes. Foot pedal or PLC controlled.

35572 Manual Shutter (EC & ECE Floods)

Most cost-effective shutter system.

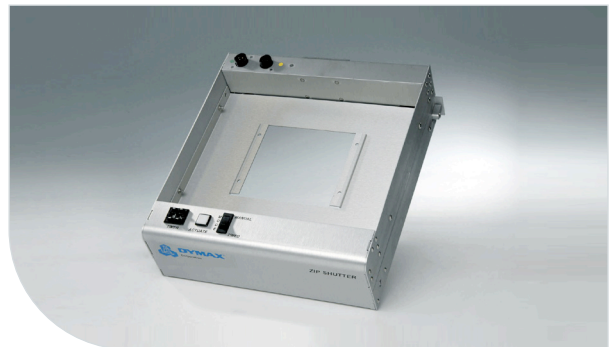

ZIP™ Shutter (ECE Floods)

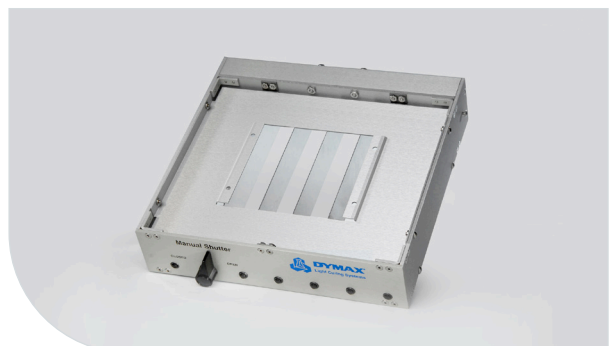

Manual Shutter



UV Broad-Spectrum & Conveyor Systems

Dymax UVCS-series conveyor systems are an ideal choice for manufacturers who need to cure light-curable adhesives, coatings, and inks on larger parts or on large quantities of smaller parts. Standard UVCS systems consist of a 12"-wide belt that can be outfitted with a variety of broad-spectrum and LED curing flood lamps. Conveyors outfitted with broad-spectrum flood lamps are available with standard metal halide (longwave UV), mercury (shortwave UV), or visible bulbs to accommodate various applications. Conveyors that utilize LED floods are available in 365, 385, and 405 nm curing wavelengths. Specialty conveyors are available for applications that require a wider belt or for parts that need to be cured from the sides and/or the bottom.

All Dymax conveyor systems are designed to offer consistent, fast, and safe curing. The systems are extremely easy to use and keep users safe by offering complete shielding from UV light. Consistent belt transport speed, adjustable lamp height, and stable lamp intensity provide a consistent light-curing process for repeatable process and optimized throughput.

Custom Conveyor Systems

Looking for a wider conveyor, shorter conveyor, or one with more clearance? Dymax can custom design a conveyor to your specifications. Contact Dymax for more information on customized conveyors.

UVCS V3.0 LED Conveyor

The UVCS V3.0 LED is a modernized conveyor packed with features for ease of use and the best quality of life. It is designed to function with Dymax's BlueWave® FX-1250 LED flood emitters, and can be configured in various mounting arrangements including single lamp, 1x3 arrays, or 2x2 arrays. With a belt width of 12", the UVCS V3.0 LED can operate at speeds from 0.4 m - 7.8 m/min, and is capable of reversible operation. Additionally, integrated sensors detect when parts enter and exit the curing tunnel, automatically toggling emitters on/off to ensure accurate process timing.

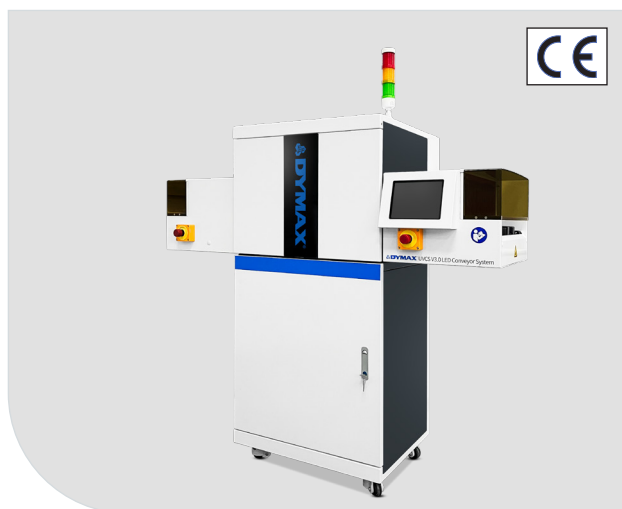

- 8" touchscreen with modern UI
- Automatic part sensing
- Multiple operating modes including high-speed conveying, static oven, and PLC mode
- Reversible conveyor belt operation
- Low ESD for electronics applications

| UVCS V3.0 LED Conveyor, Base | North American (110V) | Asian (220V) | European (220V) |
|-------------------------------|--|--------------|-----------------|
| H-Cradle Configuration | 88880 | 88884 | 88888 |
| V-Cradle Configuration | 88881 | 88885 | 88889 |
| Accessories | | | |
| Cabinet | 80020 | | |
| Emitter Cradles | 80021 Horizontal Configuration 80022 Vertical Configuration | | |

North American: Type B Power Cord
 Asian: Type I Power Cord
 European: Type F Power Cord

| UVCS V3.0 LED Conveyor | | |
|--------------------------------------|---|------|
| Conveyor Voltage | 220V | 110V |
| Amperage | 1.5A | 3A |
| Belt Width | 12" (300 mm) | |
| Belt Speed | 1.3 ft/min ~ 25.6 ft/min, in 0.3 ft/min increments (0.4 m/min ~ 7.8 m/min, in 0.1 m/min increments) | |
| Load Capacity | Left to Right: 55 lbs (25 kg) max. Right to Left: 55 lbs (25 kg) max | |
| Emitter Adjustment Range | 0.5" ~ 6" (12 - 152 mm) | |
| Noise Level | 65dBa (One emitter, fan speed setting 2) | |
| Operating Conditions | +10 to +40°C, 0 - 80% relative humidity, non-condensing | |
| Shortage Temperature | -20 to +50°C | |
| Weight (Conveyor Only) | 197 lbs (90 kg) | |
| Crated Dimensions (L x W x H) | 68" x 41" x 31" (1730 x 1046 x 795 mm) | |
| Regulatory | CE, RoHS, Machinery Directive, UKCA, China GB4793.1-2007 | |

UVCS 2.0 Conveyors

The standard Dymax conveyor platform, the UVCS series, has a belt width of 12" (304.8 mm) and can be outfitted with a number of different UV light-curing systems. Belt speed is accurately measured using an optical encoder and displayed on a digital LCD. The UVCS series conveyors are completely shielded from UV light for user protection. The standard UVCS 2.0 conveyor is most commonly outfitted with Dymax 5000-EC or Fusion® F300S curing lamps.

- Multiple flood or focused-beam configurations available
- Up to 10" clearance available (with optional risers)
- Accurate belt speed (using an optical encoder)



| | One 5000-EC (CM)* | | Two 5000-ECs (CM)* | | Two 5000-ECs (FW)** | | Four 5000-ECs (FW)** | | One Fusion F300S (CM)* | Two Fusion F300S (FW)** |
|--|--|----------|--------------------|----------|---------------------|----------|----------------------|----------|------------------------|-------------------------|
| Asian Version (Type G Plug) | - | | - | | - | | - | | 42006 | 42007 |
| Conveyor Voltage | 120V | 220/230V | 120V | 220/230V | 120V | 220/230V | 120V | 220/230V | 220/230V | |
| Amperage (With Lamps) | 4.8A | 2.4A | 4.8A | 2.4A | 4.8A | 2.4A | 4.8A | 2.4A | 2.4A | |
| Belt Width | 12" (30 cm) | | | | | | | | | |
| Belt Speed | 1-27 feet per minute | | | | | | | | | |
| Cure Width | 6" (15 cm) | | | | 12" (30 cm) | | | | 6" (15 cm) | 12" (30 cm) |
| Lamp Adjustment Range | 1.7" to 5.5" (4.3 cm to 14 cm) | | | | | | | | | |
| Max. Parts Height | 4.25" (10.8 cm) Adding risers increases to 10" (25.4 cm) | | | | | | | | | |
| Overall Dimensions (L x W x H) (Not Including Lamps) | 50.5" x 29.8" x 16.4" (128 cm x 76 cm x 42 cm) | | | | | | | | | |
| Shipping Weight (With Crates & Lamps) | 350-400 lbs. (159-181 kg) | | | | | | | | | |
| Crated Dimensions (L x W x H) | 69" x 44" x 29" (175 cm x 112 cm x 74 cm) | | | | | | | | | |

* CW (Center Mounted) - These conveyors have center-mounted lamps and are supplied with removable guides to channel parts into the middle 6" of conveyor.

** FW (Full Width) - These conveyors have lamps that span the full width of the conveyor.

UVCS LED Conveyors with BlueWave® AX-550 V2.0 Flood Lamps

Dymax UVCS bench-top conveyor systems are designed for fast curing of adhesives, coatings, and inks that react in the UVA and/or visible spectral ranges. The conveyors can be outfitted with one of three different wavelength BlueWave® AX-550 LED flood lamps (365 nm, 385 nm, or 405 nm) and can accommodate up to four emitters. If two emitters are used, they can be mounted side-by-side or front-to-back for additional process flexibility.

All UVCS conveyors have adjustable belt speeds of 1 to 32 fpm, as well as adjustable lamp-to-belt distance to address a variety of application requirements. When combined, the UVCS conveyors' consistent intensity, fast curing, and adjustable line speeds create an optimized LED light-curing process that enables high throughput.



- 365, 385, or 405 nm emitters available
- Complete shielding from light
- Counterbalanced height adjustment mechanisms for ease of emitter-to-belt distance adjustments
- 1.5" minimum height with 4", 6", or 10" vertical clearance available

| | 1 Emitter | | 2 Emitters | | | | 4 Emitters** | |
|--|---|-------|---|----------|------------|----------|---|-------|
| Base Conveyor | 43555 | 43559 | 43557 FW | 43561 FW | 43556 CM | 43560 CM | 43558 | 43562 |
| Conveyor Voltage (VAC) | 120V | 230V | 120V | 130V | 220V | 230V | 120V | 230V |
| Emitter | 60753 RediCure 60752 PrimeCure 60754 VisiCure | | 60753 RediCure (Order Qty 2) 60752 PrimeCure (Order Qty 2) 60754 VisiCure (Order Qty 2) | | | | 60753 RediCure (Order Qty 4) 60752 PrimeCure (Order Qty 4) 60754 VisiCure (Order Qty 4) | |
| Controller | 60943 | | 60943 (Order Qty 2) | | | | 60943 (Order Qty 4) | |
| Cure Width* | 5" (13 cm) | | 10" (25 cm) | | 5" (13 cm) | | 10" (25 cm) | |
| Belt Width | 12" (30 cm) | | | | | | | |
| Belt Speed | 0.8 - 32.0 ft/min (0.3 - 9.7 m/min) | | | | | | | |
| Lamp Adjustment Range | 1.5" - 4.5" (38 mm - 114 mm) | | | | | | | |
| Max. Parts Height | 4.5" (10.8 cm) | | | | | | | |
| Overall Dimensions (L x W x H) (Not Including Lamps) | 50.5" x 29.8" x 16.4" (128 cm x 76 cm x 42 cm) | | | | | | | |

* CW (Center Mounted), FW (Full Width)

Edge-Carry Conveyor

Dymax Edge-Carry conveyors are designed for efficient curing of UV and/or visible light-sensitive adhesives, inks, and coatings. These conveyors can be outfitted with a variety of lamp configurations to address a variety of application specific requirements. They offer complete shielding from UV light and consistent cure times. Configuration options allow flexibility when defining intensity requirements to keep operating costs to a minimum. Standard height clearance is 0.75" across the entire 18" width, which is ideal for low profile parts such as PCBs, and up to 6 inches across a 13.75" width, which can be increased to either 8" or 12" with optional risers installed.

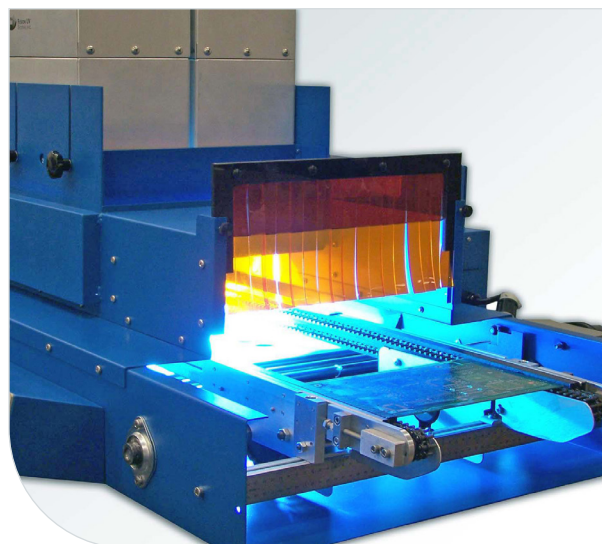

- Multiple flood or focused-beam configurations available
- Chain rail width is easily adjusted to accommodate parts widths up to 12"
- Adjustable lamp-to-part distance

| | 5000-EC | | | | | | | | 2000/1200-EC | | Fusion F300 | |
|--|--|-------|-------------------|-------|--------------|-------|-------------------|-------|-------------------|----------------|-------------------|-------------------|
| | 1 Lamp, CM* | | 2 Lamps, CM* | | 2 Lamps, FW* | | 4 Lamps, FW* | | 1 Lamp, CM* | | 1 Lamp, CM* | 2 Lamps, FW* |
| Part Number | 40324 | 40328 | 40325 | 40329 | 40326 | 40275 | 40327 | 40331 | 40334 40335 | 40332 40333 | 40336 | 40280 |
| Conveyor Voltage | 120V | 230V | 120V | 230V | 120V | 230V | 120V | 230V | 115 or 208-240V | | 208-240V | |
| Amperage (With Lamps) | 9.6A | 4.8A | 17.6A | 8.8A | 17.6A | 8.8A | 33.6A | 16.8A | TBD | TBD | 16A | 32.6A |
| Max. Chain Spacing | 18" (45.7 cm) | | | | | | | | | | | |
| Conveyor Speed | 1-32 feet per minute | | | | | | | | | | | |
| Cure Width | 6" (15 cm) | | | | 12" (30 cm) | | | | 9" (23 cm) | | 6" (15 cm) | 12" (30 cm) |
| Lamp Adjustment Range | 3.5" - 7.3" (8.9 cm - 18.5 cm) | | | | | | | | | | | |
| Max. Parts Height | 6.25" (15.86 cm) | | | | | | | | | | | |
| Overall Dimensions (L x W x H) (Not Including Lamps) | 59" x 35" x 39.5" (150 cm x 89 cm x 100 cm) | | | | | | | | | | | |
| Shipping Weight (With Crates & Lamps) | 390 lbs. (177 kg) | | 410 lbs. (186 kg) | | | | 450 lbs. (204 kg) | | 390 lbs. (177 kg) | | 475 lbs. (215 kg) | 580 lbs. (263 kg) |

* CW (Center Mounted) - These conveyors have center-mounted lamps and are supplied with removable guides to channel parts into the middle 6" of conveyor.
 FW (Full Width) - These conveyors have lamps that span the full width of the conveyor.

UVCS SideCure Conveyor

The UVCS SideCure conveyor system is designed for the UV curing of adhesives and coatings from the sides and/or top. The SideCure conveyor can be outfitted with up to eight 5000-EC UV curing flood lamps that offer complete shielding from UV light and consistent exposure times. The conveyor's 12" wide belt and 5" high side-curing capability makes the SideCure a very versatile UV curing solution. The SideCure conveyor is ideal for masking, medical, and electronic applications where 180° UV curing is required.

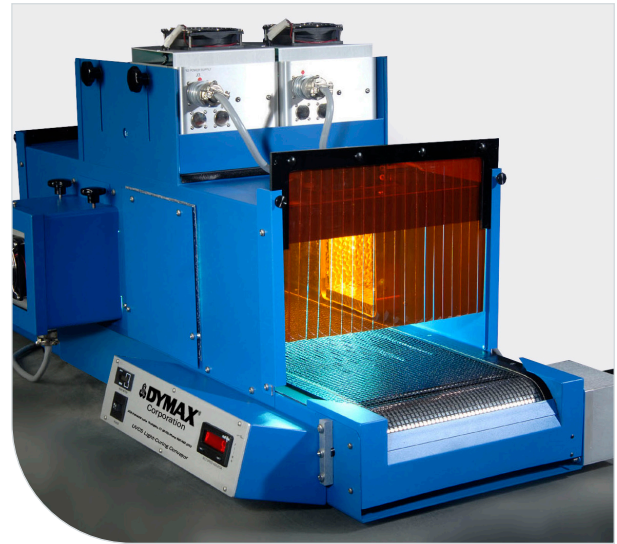

- Left, right, and top curing capability
- Adjustable top lamp height and side lamp position
- Accurate digital belt control and readout
- Controlled and consistent cure times
- Accepts parts up to 36" x 12" x 7" (L x W x H)

| UVCS SideCure with up to FOUR Side Lamps (lamps sold separately) | |
|--|---|
| Lamps (SideCure 5000-ECs PN 39798) | Up to eight |
| Part Number | 39767 39766 |
| Conveyor Voltage | 115V 220/230V |
| Amperage (With Lamps) | 1.6A 0.9A |
| Belt Width | 12" (30 cm) |
| Belt Speed | 1-27.5 feet per minute |
| Cure Width | 6" (15 cm) or 12" (30 cm) depending upon number and orientation of lamps |
| Lamp Adjustment Range | Top Lamps: From 6.25" to 9" off the belt (16 cm to 23 cm) Side Lamps: From 3.5" to 6" off center (9 cm to 15 cm) |
| Max. Parts Height | 7" (17.8 cm) |
| Overall Dimensions (L x W x H) (Not Including Lamps) | 51" x 30" x 21.5" (130 cm x 76 cm x 55 cm) |
| Shipping Weight (With Crates & Lamps) | 450-500 lbs. (204-227 kg) |
| Crated Dimensions (L x W x H) | 72" x 52" x 31" (183 cm x 132 cm x 79 cm) |

WIDECURE® Conveyor

The WIDECURE® conveyor system is designed to offer consistent, fast, and safe curing. Equipped with a 25" (63.5 cm) wide belt, this system is ideal for curing light-curable materials on larger parts, or larger quantities of smaller parts. It can be outfitted with either a longwave (metal halide, UVA/Visible) bulb or a shortwave (mercury, UVB/UVC) bulb and delivers up to 700 mW/cm² of curing energy.

Designed to help manufacturers build a more reliable cure process, the WIDECURE allows users to easily control various curing parameters through a touch-screen control panel. This feature gives users greater curing flexibility and enables them to tailor the curing conditions to their specific application. The system's tightly controlled belt speed and minimal bulb degradation also allow better control over cure. This provides repeatable curing profiles and a more reliable process with less risk of variance.

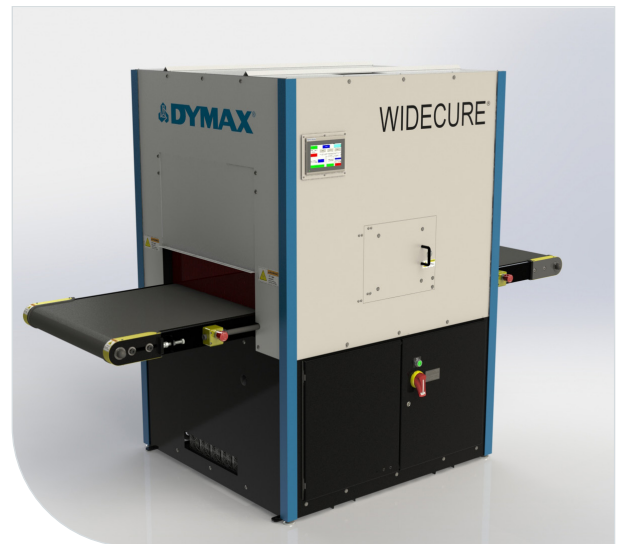

- 25" (63.5 cm) wide belt with 24" (61 cm) curing width
- Touchscreen control panel
- Line speeds from 4-30 fpm, adjustable in 0.1 fpm increments
- Easily adjustable lamp-to-belt distance (4"-24")
- Integral vacuum hold-down and cooling system

| WIDECURE® UV Light-Curing Conveyor System | |
|---|---|
| Part Number | 41245-L Standard WIDECURE Conveyor where belt travels left-to-right 41245-R Optional WIDECURE Conveyor where belt travels right-to-left* |
| Conveyor Voltage | 480V |
| Amperage (With Lamps) | 30A |
| Belt Width | 25" (63.5 cm) |
| Belt Speed | Adjustable 4 - 30 feet per minute |
| Cure Width | 24" (61 cm) |
| Lamp Adjustment Range | 4" to 24" (10.16 cm to 61 cm) |
| Max. Parts Height | 18" (45.7cm) |
| Overall Dimensions (L x W x H) (Not Including Lamps) | 113.5" x 46" x 76" (288.3 cm x 116.8 cm x 193 cm) |
| Shipping Weight (With Crate) | 1,700 lbs. (771 kg) |
| Crated Dimensions (L x W x H) | 120" x 56" x 90" (305cm x 142cm x 229cm) |

* Requires modification charge and additional lead-time.

Accessories

Carts

39215 Transportation Cart

Easily move your conveyor with one of these durable, rolling carts.



Replacement Bulbs

38560 Metal-Halide Bulb (Standard, UVA, Longwave)

For use with UVCS, SideCure, & Edge-Carry conveyors outfitted with Dymax EC-series flood lamps.

36970 Mercury Bulb (UVB, Shortwave)

For use with UVCS, SideCure, & Edge-Carry conveyors outfitted with Dymax EC-series flood lamps. These bulbs are primarily designed for curing UV inks and cationic epoxies.

36658 Visible Bulb

For use with UVCS, SideCure, & Edge-Carry conveyors outfitted with Dymax EC-series flood lamps. The bulbs are primarily designed for curing UV/visible curing adhesives through UV-blocked, but transparent substrates.

36399 "D" Bulb (Standard)

For use with UVCS, SideCure, & Edge-Carry conveyors outfitted with Fusion lamps.

Replacement Bulbs

36441 "H" Bulb

For use with UVCS, SideCure, & Edge-Carry conveyors outfitted with Fusion lamps. These bulbs are primarily designed for curing UV inks and cationic epoxies.

38146 "V" Bulb

For use with UVCS, SideCure, & Edge-Carry conveyors outfitted with Fusion lamps. The bulbs are primarily designed for curing UV/visible curing adhesives through UV-blocked, but transparent substrates.

41247 Metal-Halide Bulb

For use with WIDECURE conveyors

41246 Mercury Bulb

For use with WIDECURE conveyors

Belts

41248 Replacement Belt for WIDECURE Conveyor

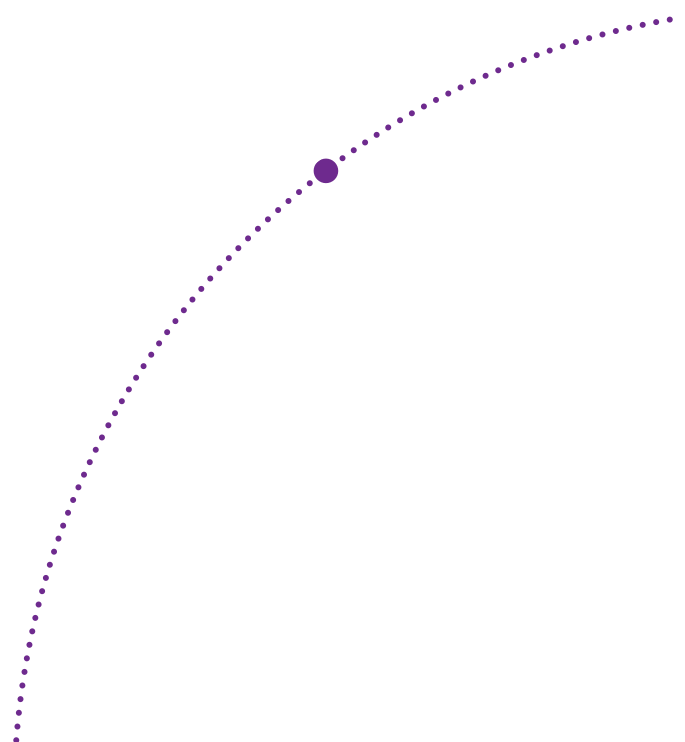

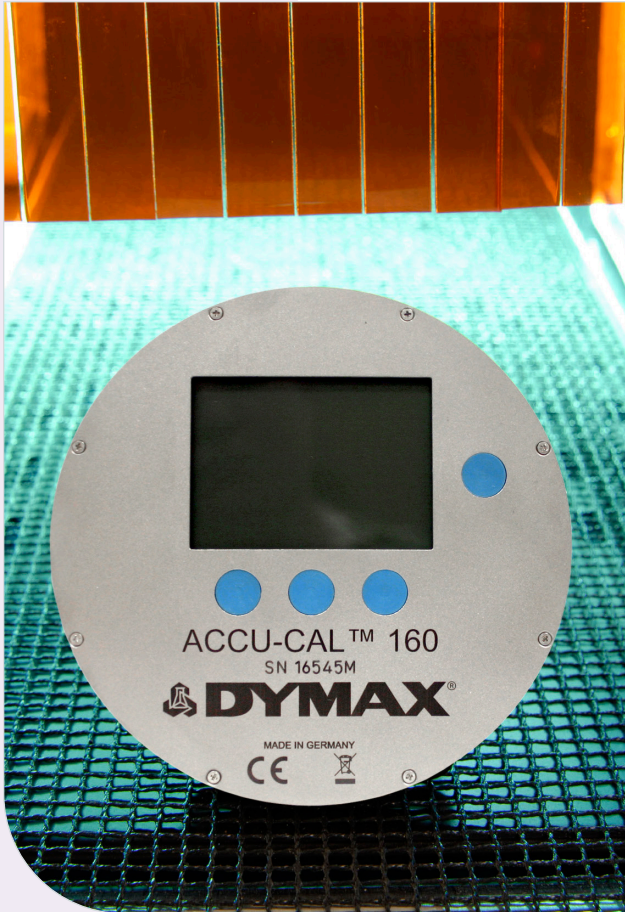

Radiometers for Spot, Flood, and Conveyor Systems

Radiometers measure the intensity of energy at specific wavelengths. UV light is, by definition, not visible to the human eye, so a radiometer is required to determine the amount of UV energy. The ability to measure light intensity is useful for three reasons:

- **Maintaining a light-curing process** – A radiometer can measure whether a light-curing system is providing intensity above the “bulb change” intensity. A radiometer is to a light-curing process what a thermometer is to a heat-curing process.
- **Providing a worker-friendly light-curing process** – A radiometer is required to determine if any UV light is reaching operators or bystanders.
- **Measuring transmission rates through substrates** – A radiometer can be used to measure the transmission rates of various wavelengths through substrates that absorb UV and/or visible light. To assure an effective curing process it is critical to measure the light intensity reaching the light-curable material below the intervening substrate.

Dymax ACCU-CAL™ Radiometers

Dymax offers ACCU-CAL™ radiometers for spots, floods, and conveyors. Kits for spot lamps include the complete radiometer with 3, 5, and 8-mm lightguide adapters and a lightguide simulator. Adapter kits are available separately for users who have an existing flood/conveyor kit and need to use it for spot systems. All radiometer kits include a storage/carrying case. ACCU-CAL™ radiometers are calibrated to measure either UV-A (320-390 nm), LED (~ 350-450 nm), or visible (395 nm to 465 nm) light intensity.

Radiometer Calibration

To ensure accurate readings, radiometers should be periodically calibrated. Calibration requirements differ from one model to another but calibration is typically required every six or twelve months. Please refer the Dymax Radiometer Calibration Schedule, available for download on our website, for the calibration requirements for your specific radiometer model. Calibration services are available through Dymax and can be scheduled by submitting the [Calibration Request Form](#) found on the dymax website or by contacting your local Dymax Customer Support Team.

ACCU-CAL™ 50

The ACCU-CAL™ 50 radiometer is simple to operate and offers repeatable measurement of UV light. The ACCU-CAL™ 50 can measure UV light emitted from lightguides (3, 5, and 8 mm), UV flood systems, and UV conveyors. With a spectral sensitivity from 320 to 395 nm (UVA), the ACCU-CAL™ 50 measures intensities from 1 mW/cm² to 40 W/cm². A specially designed photo-sensor assembly protects the photo-sensor from the high temperatures sometimes associated with today's high intensity UV spot lamps.

39561 ACCU-CAL™ 50 for flood lamps and conveyors

Complete radiometer (without lightguide adapters or lightguide simulator*); includes storage/carrying case.

39560 ACCU-CAL™ 50 for spots, floods, and conveyors

Complete radiometer with lightguide adapters (3, 5, and 8 mm) and lightguide simulator*; includes storage/carrying case.



- Spectral sensitivity of 320-395 nm
- 12 month calibration cycle
- Can be used to test spot or flood lamps, as well as conveyor systems
- Set screw locks lightguide in place
- PTB and NIST traceable

ACCU-CAL™ 50V

The ACCU-CAL™ 50V radiometer is simple to operate and offers repeatable measurement of visible light. The ACCU-CAL™ 50V can measure visible light energy emitted from lightguides (3, 5, and 8 mm), flood systems, and conveyors. With a spectral sensitivity from 400 to 470 nm (blue portion of the visible spectrum), the ACCU-CAL™ 50V measures intensities from 1 mW/cm² to 40 W/cm². A specially designed photo sensor assembly protects the photo sensor from the high temperatures sometimes associated with today's high-intensity spot lamps.

40044 ACCU-CAL™ 50V for flood lamps and conveyors

Complete radiometer (without lightguide adapters or lightguide simulator*); includes storage/carrying case.

40043 ACCU-CAL™ 50V for spots, floods, and conveyors

Complete radiometer with lightguide adapters (3, 5, and 8 mm) and lightguide simulator*; includes storage/carrying case.



- Spectral sensitivity of 400-470 nm (visible)
- 12 month calibration cycle
- Can be used to test spot or flood lamps, as well as conveyor systems
- Set screw locks lightguide in place
- PTB and NIST traceable

*A lightguide simulator is used to measure direct spot lamp intensity (required to calculate lightguide transmission)

ACCU-CAL™ 50-LED

The ACCU-CAL™ 50-LED radiometer is simple to operate and offers accurate measurement of curing energy. The ACCU-CAL™ 50-LED can measure energy levels emitted from lightguides (3, 5, and 8 mm), BlueWave® QX4® LED heads, LED flood lamps, and line-pattern curing systems. A spectral sensitivity range of 350 - 450 nm and intensity measurement from 1 mW/cm² to 40 W/cm², makes this unit ideal for measuring LED curing source energy levels. A specially designed photo-sensor assembly provides repeatable measurements and protection from high temperatures associated with some LED systems on the market.

40505 ACCU-CAL™ 50-LED for LED spot and flood units

Complete radiometer with 3, 5, and 8 mm lightguide adapters, lightguide simulator*, and an optical adapter for use with the BlueWave® QX4 and BlueWave® MAX-275; includes storage/carrying case.

40519 - ACCU-CAL™ 50-LED for LED floods and conveyors

Complete radiometer (without lightguide adapters or lightguide simulator*); includes storage/carrying case.

39554 Flood-to-Spot Adapter Kit

Kit includes three lightguide adapters (3, 5, and 8 mm) and a lightguide simulator.

42218 BlueWave® QX4 Optic Adapter Upgrade Kit

Kit includes the optic adapter and updated software and calibration for an existing radiometer. The customer's radiometer must be returned to Dymax for programming and calibration.

43383 Line Optic Adapter Upgrade Kit for the BlueWave® QX4 and BlueWave® MX-275

Kit includes the optic adapter and updated software to allow your radiometer to measure line-pattern systems. It also includes calibration for your existing radiometer. The customer's radiometer must be returned to Dymax for programming and calibration.



- Spectral sensitivity of 360-450 nm
- 12 month calibration cycle
- Can be used to test spot or flood lamps, as well as conveyor systems
- Set screw locks lightguide in place
- PTB and NIST traceable

*A lightguide simulator is used to measure direct spot lamp intensity (required to calculate lightguide transmission)

ACCU-CAL™ 160

The ACCU-CAL™ 160 radiometer is available in both a UV and LED model and can measure UV or LED light up to 10 W/cm² emitted from stationary light-curing flood lamps or lamps used in conveyorized processes. This radiometer can be used to determine intensity (measured in mW/cm²) or total energy as derived from intensity and exposure time (measured in mJ/cm²). The ACCU-CAL™ 160 offers a number of improved features and benefits including a longer calibration cycle (12 months instead of 6), an easier-to-use set-up screen, and a graphical display that is clearer and easier-to-read. The unit is simple to operate and can be controlled via four buttons on the faceplate. Measurement results are displayed on the integrated LCD display or transmitted by the USB interface to a computer. A data download kit is included with each radiometer at no charge and downloads easily into Microsoft Excel.

41590 ACCU-CAL™ 160 UVA

41585 ACCU-CAL™ 160 LED



- LED or UVA models available
- Spectral sensitivity of 328-382 nm (UVA model) or 350-460 nm (LED model)
- 12 month calibration cycle
- +/- 0.5 accuracy
- Clear, easy-to-read graphical display
- For use with flood lamp or conveyor systems

*A lightguide simulator is used to measure direct spot lamp intensity (required to calculate lightguide transmission)

Equipment Programs

Take advantage of the opportunity to evaluate Dymax equipment with our Try & Buy Program or upgrade your existing light-curing equipment using our new Trade-In Program.

Try & Buy: Dymax Try & Buy is a low-risk way to evaluate Dymax equipment in your application before purchasing it. After the two-week trial period, rental of the unit will be billed monthly. Typically, after six payments, the system is yours to keep. This program applies to curing and dispense equipment systems only, and excludes all consumable parts and accessories.

Trade-In: Upgrade your existing light-curing equipment to the latest Dymax model regardless of what brand you're using today. The program allows one trade-in per purchase of a new, full price piece of Dymax equipment. Conditions and exclusions apply.

For more information, reach out to Dymax Customer Support or submit an application online at dymax.com/sales-support/contact-us.



www.dymax.com

Americas

USA | +1.860.482.1010 | info@dymax.com

Europe

Germany | +49 611.962.7900 | info_de@dymax.com

Ireland | +353 21.237.3016 | info_ie@dymax.com

Asia

Singapore | +65.67522887 | info_ap@dymax.com

Shenzhen | +86.755.83485759 | info@hanarey.com

Hong Kong | +852.2460.7038 | dymaxasia@dymax.com

Korea | +82.31.608.3434 | info_kr@dymax.com

©2021-2024 Dymax Corporation. All rights reserved. All trademarks in this guide, except where noted, are the property of, or used under license by, Dymax Corporation, U.S.A.

Technical data provided is of a general nature and is based on laboratory test conditions. Dymax does not warrant the data contained in this bulletin. Any warranty applicable to the product, its application and use, is strictly limited to that contained in Dymax's standard Conditions of Sale. Dymax does not assume responsibility for test or performance results obtained by users. It is the user's responsibility to determine the suitability for the product application and purposes and the suitability for use in the user's intended manufacturing apparatus and methods. The user should adopt such precautions and use guidelines as may be reasonably advisable or necessary for the protection of property and persons. Nothing in this bulletin shall act as a representation that the product use or application will not infringe a patent owned by someone other than Dymax or act as a grant of license under any Dymax Corporation Patent. Dymax recommends that each user adequately test its proposed use and application before actual repetitive use, using the data contained in this bulletin as a general guide.

SG014DA 8/29/2024