

**LIGHT-CURABLE MATERIALS
FOR CONSUMER ELECTRONICS
ASSEMBLY**

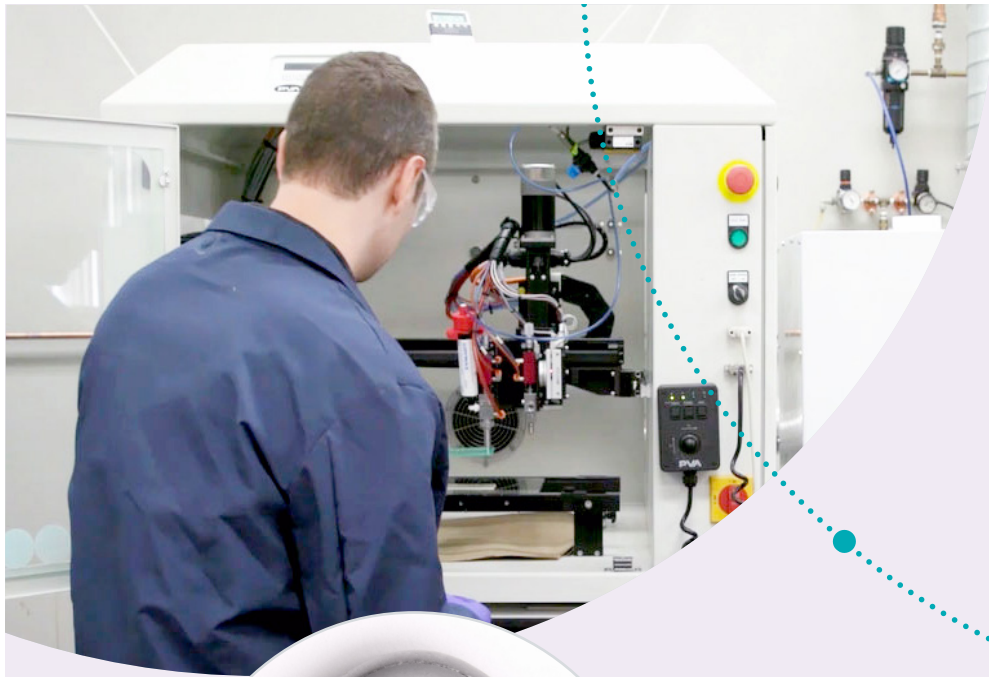

Only Dymax offers expert knowledge of light-cure technology, along with a full array of light-cure products. Dymax is committed to developing a true collaborative partnership — applying our extensive process knowledge to your specific application challenges.

We create custom solutions to ensure that chemistry and equipment work seamlessly together with maximum efficiency. Our application engineering team works side-by-side with our customers, providing assistance with formulation, testing, evaluation, and pre-production trials. We also offer an extensive inventory of curing equipment, manual and automated dispensing systems to help you achieve a more efficient, cost-effective manufacturing process.

About Our Products

The consumer electronics industry is rapidly evolving at a faster rate than ever before. Today's complex designs, innovative materials, and increased focus on the environment can present challenges to many manufacturers. Whatever demands or challenges you face, Dymax is here to work with you to design a more efficient process for a higher quality end product.

From conformal coatings and encapsulants to edgebond materials and adhesives for camera lens assembly, Dymax provides innovative UV light-curing technology solutions with no solvents added. We offer many cost-reducing solutions that turn problems like shadowed areas, cure confirmation, and production throughput into non-issues. IPC approved, MIL-I-46058C and UL listed self-extinguishing grades are available.

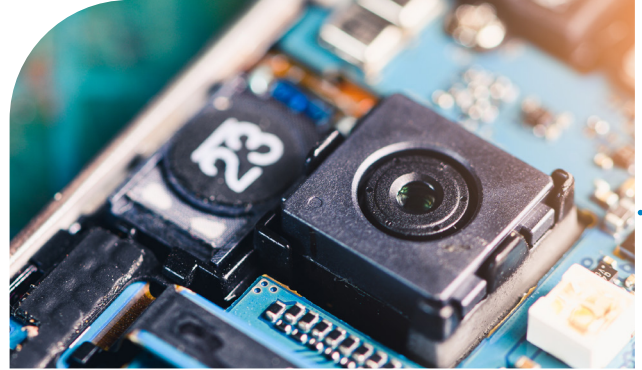

Our Commitment to Greener, Safer Manufacturing

Dymax is committed to green manufacturing that reduces environmental impact, conserves energy, and provides greater worker safety. Over the last 40 years, our light-curable materials and curing equipment have become the industry standard for fast, environmentally conscious assembly. Dymax products are readily replacing technologies that contain hazardous ingredients, produce waste, or require higher amounts of energy to process.

Many of our materials for consumer electronics assembly are certified as halogen free and meet or exceed standards set forth in IEC 61249-2-21. This international directive defines halogen-free as <900 ppm for chlorine, <900 ppm for bromine and <1,500 ppm total level of both combined. The current test method used for certification is BS EN 14582:2007.



Eco-friendly, one-component materials



Materials with no added solvents, halogens, or other materials of concern for improved worker and user safety



Fast curing products and equipment designed for less energy consumption



Dymax meets global statutory and regulatory requirements

Typical Applications



- 1. Camera Module Assembly
- 2. Micro Speaker Assembly
- 3. LED Coating
- 4. LCD Laminating
- 5. LCD - Form-In-Place Gasket
- 6. Hard Coating for Screen Protection

- 7. Flex Circuit Bonding
- 8. IC - Ruggedization (Underfill Alternative)
- 9. Masking for Protection During Processing
- 10. Tamper Proofing
- 11. PCB - Conformal Coating
- 12. PCB - Masking

Encapsulants for Printed Circuit Boards

Dymax light-curable materials cure in seconds upon exposure to UV and/or visible light to produce tough, flexible encapsulants for bare die, wire bonds, or integrated circuits (IC). The encapsulants' fast cure helps reduce processing and energy costs associated with alternative technologies. The materials are all one part, so no mixing is required and viscosity is consistent. In addition, Dual-Cure light/moisture cure encapsulants are available to address shadowed area concerns.

Dymax encapsulating materials have high ionic purity, and resistance to humidity and thermal shock, which effectively protect components. Our encapsulants contain no sharp, abrasive, mineral or glass fillers which may abrade fine wires. Their combination of low Tg and low modulus translates into low stress for bonded wires.

UV light-curing and UV/Moisture-cure resins are ideal for glob-top and chip-on-board applications. They may also be used on flex circuits (FPC) for encapsulating ICs, coating the circuit, or attaching it to glass or PCB. A wide range of viscosities from thin wicking to non-flowing gel are available.

Product Number	Features	Viscosity, cP	Durometer Hardness	Tensile at Break, MPa [psi]	Modulus of Elasticity, MPa [psi]	Halogen Free?
9014	UV/Visible light-curing with secondary moisture cure; flexible	12,500	A70	8.2 [1,200]	119 [17,300]	
9037-F	UV/Visible light cure with secondary heat cure; flexible; moisture and thermal resistance; blue fluorescing	50,000	D40	5.8 [850]	6.2 [900]	
9-20558-REV-A	UV/Visible light-curing with secondary heat cure; high viscosity; flexible; bonds well to FPCs	24,000	D35	6.2 [900]	2.3 [340]	
9008	UV/Visible light cure; flexible; moisture resistant; excellent adhesion to polyimide	4,500	D35	10 [1,500]	45 [6,500]	
9101	UV/Visible light cure with secondary moisture cure; flexible; moisture and thermal resistance	7,000	D30-D50	5.06 [735]	175 [2,550]	
9102		17,000		4.8 [703]	18.4 [2,670]	
9103		25,000		4.9 [718]	176 [2,560]	

 Featured Product

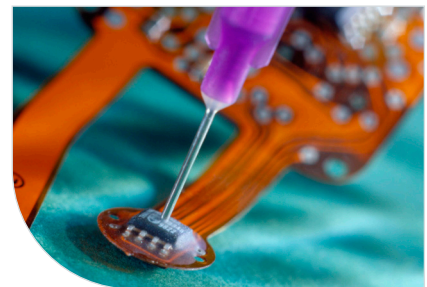
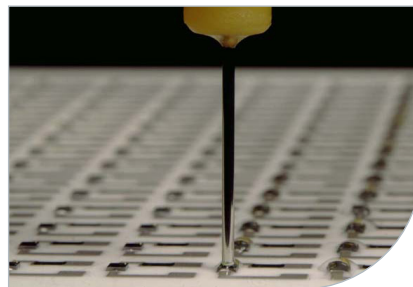
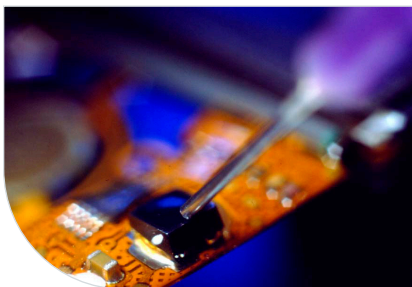

Materials for Camera Module Assembly





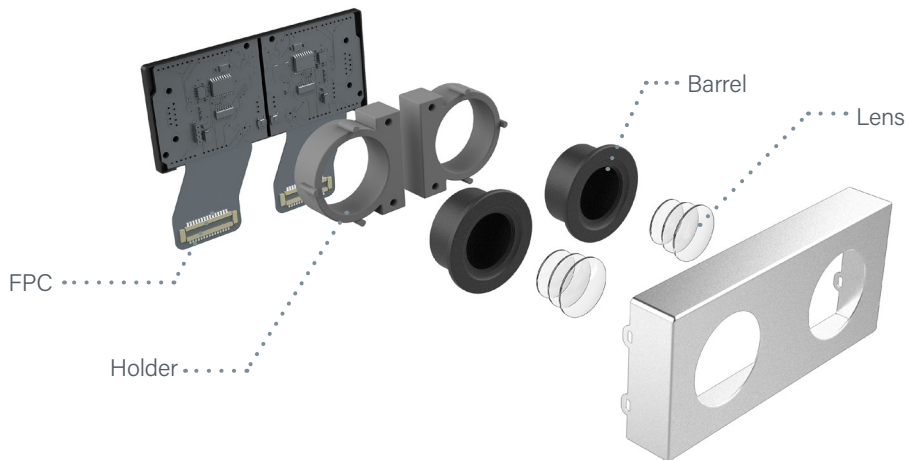
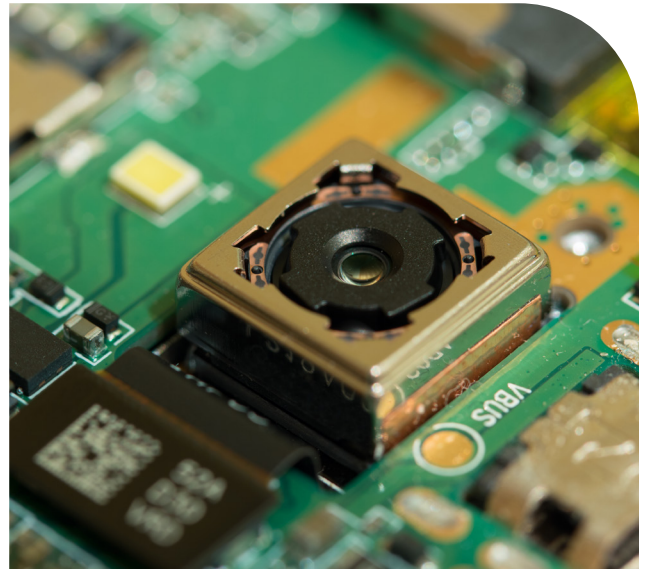



Dymax light-curable adhesives are ideal for use in the assembly of camera modules used in smart connected devices, automobiles, and industrial camera systems. Our adhesives cure in seconds, providing greater product yields in a much shorter assembly time. They provide excellent adhesion to substrates typically used in the manufacture of electronic device housings and camera modules, and can withstand harsh conditions like the moisture and shock which electronic devices are often exposed to.

- Excellent adhesion to commonly used substrates in camera module assemblies
- Materials cure in seconds allowing faster processing and higher throughput
- Materials available for a variety of applications including active alignment, barrel fixturing, and FPC reinforcement
- Good resistance to moisture and shock



TYPICAL CAMERA MODULE APPLICATIONS

1. Bonding the camera lenses
2. Fixturing the lens barrel to lens holder
3. Flexible PCB reinforcement
4. Bonding the lens holder to the PCB (active alignment)

Product Number	Features	Viscosity, cP	Durometer Hardness	Tensile at Break, MPa [psi]	Modulus of Elasticity, MPa [psi]	Halogen Free?
Fixturing the Camera Lens Barrel to the Lens Holder Typical requirement: Tack-free surface						
3094-T-REV-A	UV/Visible light cure; fast curing; low shrinkage and stress	11,750	D65	12.4 [1,800]	179 [26,000]	
3094-GEL-REV-A	UV/Visible light cure; fast curing; low shrinkage	30,000	D67	14 [2,000]	698 [101,300]	
9801	Low shrinkage epoxy; UV/Visible light cure; LED curable; low temp. heat cure (80-85°C); moisture & thermal cycle resistant; low water absorption; cold storage/ship	60,000	D90	45 [6,600]	1,600 [230,600]	Not Tested
3094-T-TF*	UV/Visible light cure with secondary heat cure; fast curing; low shrinkage and stress	6,500	D67	13.8 [2,000]	650 [94,317]	
9803	Very low shrinkage epoxy; UV/Visible light cure; LED curable; low temp. heat cure (80-85°C); moisture & thermal cycle resistant; low water absorption; cold storage/ship	86,000	D94	36.7 [5,328]	3,983 [578,000]	Not Tested
Flexible PCB Reinforcement Typical requirement: Flexibility; bend resistance						
9008	UV/Visible light cure; remains flexible to -40°C; moisture resistant	4,500	D35	10 [1,500]	45 [6,500]	
9101	UV/Visible light cure with secondary moisture cure; flexible; moisture and thermal resistant	7,000	D30-D50	5.06 [735]	17.5 [2,550]	
Other Applications						
9309-SC	UV/Visible light cure; adhesion to various PCB substrates; formulated with See-Cure color-change technology	45,000	D57	22 [3,200]	163 [23,800]	
6-621-GEL	UV/Visible light cure with secondary heat cure; activator cure; hard, clear bonds	25,000	D80	28 [4,000]	730 [106,000]	
6-621-VT		14,000				
6-621-T	UV/Visible light cure with secondary heat cure; activator cure; hard, clear bonds	3,500	D80	28 [4,000]	730 [106,000]	
9001-E-V3.0	UV/Visible light cure; low ionic; good electrical properties	400	D45	5.17 [750]	17.2 [2,500]	

* This product is not available for sale in Europe. Featured Product





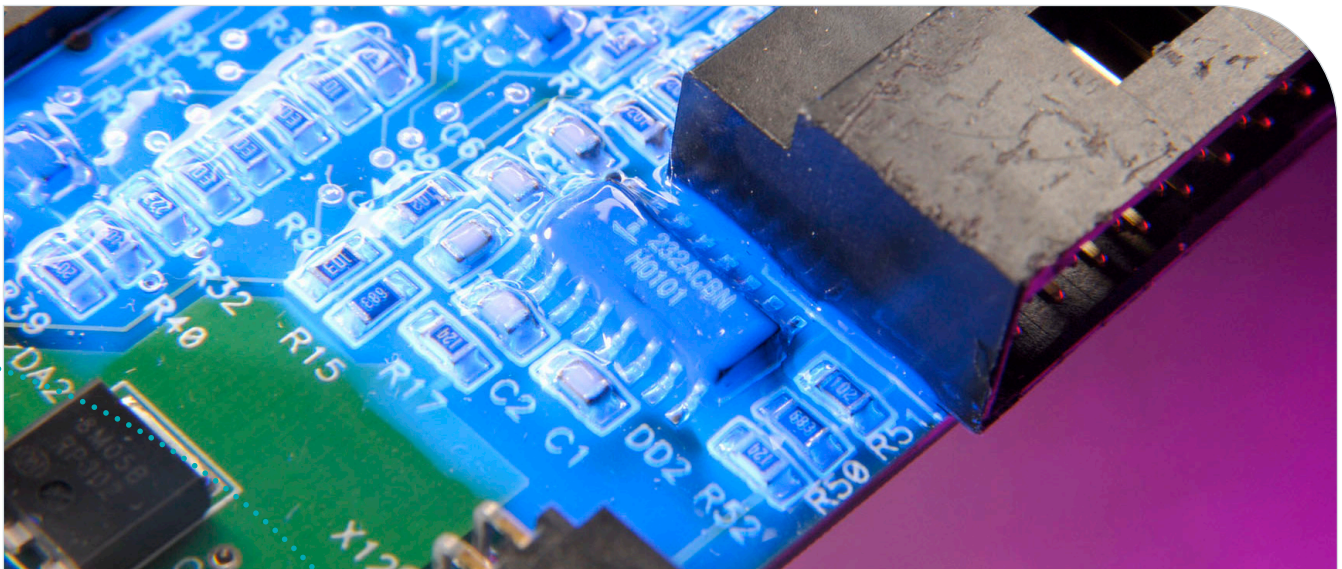

Conformal Coatings

Dymax conformal coatings for printed circuit boards cure tack free in seconds upon exposure to UV/Visible light to help streamline manufacturing assembly processes. Apply, cure, and ship immediately and eliminate the time-consuming steps of traditional thermal-cure and room temperature-cure conformal coatings. Each conformal coating is one part (no mixing required) for easy dispensing and is electrically insulated so it can be applied over the entire PCB surface or in select areas to provide protection from service environments.

Dymax conformal coatings are available for tin whisker mitigation, humid environments, and are also available with Dual-Cure technology. Dual-Cure products cure over time in shadowed areas with moisture, eliminating the need for a second process step and concerns of component life degradation due to temperature exposure. Our conformal coatings have no solvents added and contain very low VOCs, eliminating the need for solvent handling, while enhancing worker safety and minimizing environmental impact.

- One-part coatings with no solvents added for a greener, safer coating process
- Tack-free surface after light cure in seconds
- Low stress under thermal cycling
- Excellent environmental resistance
- Rigid and flexible coatings available
- Fluorescing coating available for quick, easy inspection of coating coverage
- Black conformal coating available for high security applications



Product	Features	Viscosity, cP	Durometer Hardness	Tensile at Break, MPa [psi]	Modulus of Elasticity, MPa [psi]	Approvals	Halogen Free?
9-20557	Secondary heat cure; flexible; medium-viscosity coating for thin coating applications; blue fluorescing	2,300	D60	15.8 [2,300]	379 [5,500]	MIL-I-46058C IPC-CC-830-B UL 94V-1 UL 746	
9451	Matte black finish; secondary heat cure for shadow areas; optimized for single pass coating up to 0.004"	6,000	—	42.7 [6,200]	717 [104,000]	UL 94V-0	
9483	Secondary moisture cure; excellent thermal shock resistance; corrosion resistant; blue fluorescing	750	D60	16.2 [2,350]	276 [40,000]	MIL-I-46058C IPC-CC-830-B UL 94V-0 UL 746E	
984-LVUF	Secondary heat cure; flexible for enhanced thermal shock performance; blue fluorescing	160	D85	55.8 [8,100]	724 [105,100]	MIL-I-46058C IPC-CC-830-B UL 94V-0 UL 746C	
9452-FC	Secondary heat cure; LED curable; low viscosity; very good thermal shock resistance; blue fluorescing	20	D60	34 [4,950]	1,137 [165,000]	UL 94V-0	
9481-E*	Secondary moisture cure for shadow areas; chemically resistant; blue fluorescing	125	D75	11 [1,600]	150 [21,800]	MIL-I-46058C IPC-CC-830B UL 94V-0 UL 746E	
9482*	Secondary moisture cure; thermal shock and chemical resistance; blue fluorescing	1,100	D70	15.8 [2,300]	275 [40,000]	MIL-I-46058C IPC-CC-830B UL 94V-0 UL 746E	

 Featured Product

*This material is not available for use in the United States

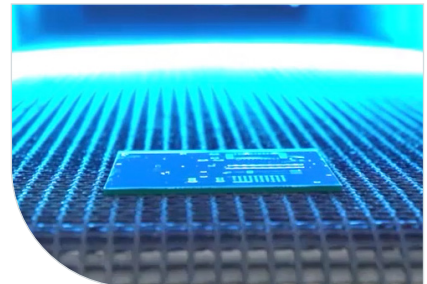
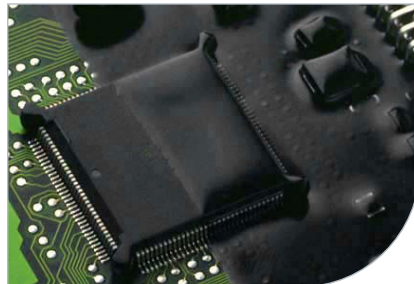
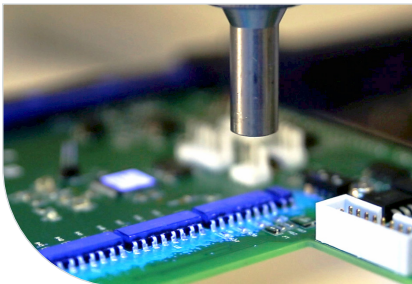

Materials for Display Lamination and Assembly

Dymax light-curable adhesives for display lamination and bonding are specifically formulated for applications where durable, crystal-clear, invisible bonds are required. Their fast, on-demand cure allows substrates to be repositioned precisely until parts are ready to be cured. One-part LCD adhesives are ideal for bonding flat panel displays, touch screens, LCD screens, liquid crystal displays, mobile phones, and many other electronic devices.



Benefits of Dymax display lamination adhesives include:

- Very low yellowing for increased light transmission, enhanced brightness, optical clarity, and better contrast ratios
- Excellent bond strength
- Superior re-workability for easy removal or repair
- Easy flow characteristics for flat panel lamination
- Excellent thermal shock resistance
- Low shrinkage minimizes visible distortion after cure

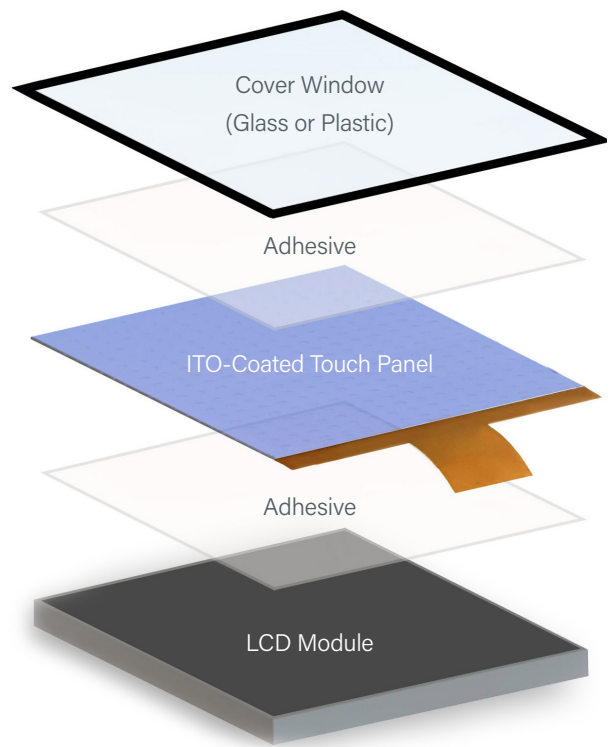
LCD adhesives also help reduce air entrapment and bubbles to create strong, ripple-free bonds that help increase panel strength. They also act as a barrier against stressing, significantly improving product reliability and minimizing warranty costs.



Typical Display Construction

Product Number	Features	Viscosity, cP	Durometer Hardness	Tensile at Break, MPa [psi]	Modulus of Elasticity, MPa [psi]	Halogen Free?
9701	Excellent re-workability; very low yellowing; low shrinkage; good thermal shock resistance; bonds to a variety of surfaces	200	00-70	0.49 [71]	0.54 [79]	
9702	Excellent re-workability; low shrinkage; very low yellowing; good thermal shock resistance; bonds to a variety of surfaces	950	00-70	0.89 [129]	0.36 [52]	
9703	High viscosity making it ideal for edge damming applications; low shrinkage; very low yellowing; good thermal shock resistance; excellent re-workability; bonds to a variety of surfaces	30,000	00-80	1.85 [268]	0.73 [106]	

Form-in-Place/Cure-in-Place Gaskets

Light-curable form-in-place, cure-in-place gasket materials are designed for automated dispensing to support high-volume production and consistency in bead profile for single-wall, flat-surface, or channel configurations. The materials act as a barrier to prevent absorption or penetration of air, dust, noise, liquids, gaseous substances, or dirt for sound dampening, vibration dampening, moisture protection, chemical protection, and air sealing. The gaskets conform to complex and intricate channels, on both vertical and horizontal surfaces, with thixotropic formulations, and flow into channels with Newtonian formulations.

This technology accommodates engineering changes without high tooling investment, helping to reduce costs, and turning problems like production throughput into non-issues. Dymax is dedicated to reducing environmental impact. Our one-part gasket resins are silicone free and replace technologies that contain hazardous ingredients, produce waste, and require higher amounts of energy to process. We understand that safe, ecologically friendly products benefit our customers, the environment, and us. We have created materials with attributes that lower product costs, life-cycle costs, and ecological impact.

Product	Features	Durometer Hardness	Nominal Viscosity, cP	Tensile at Break, MPa [psi]	Modulus of Elasticity, MPa [psi]
GA-142-F	Soft, tacky gasket with good adhesion to nylons and metals; cures in seconds with UV/visible light; blue fluorescing for easy black-light inspection	00-60	40,000	0.24 [36]	0.01 [2]

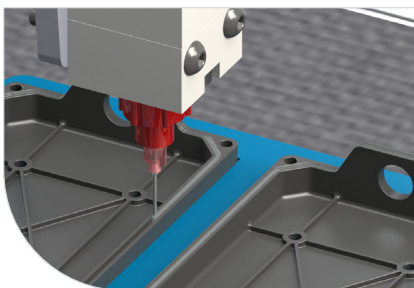

Materials for Micro Speaker Applications

With consumers increasingly turning to their phones and other smart devices for music and multimedia applications, the necessity for high-quality micro speakers has drastically increased. UV light-curable adhesives are ideal for micro speaker applications because they provide a strong bond to plastics and metals while providing enough flexibility that sound properties are not compromised.

Dymax adhesives for speaker assembly cure in seconds for optimal performance in speaker applications and can be used in a number of applications including bonding speaker magnets, cones, speaker membranes, and voice coils.

Product	Features	Viscosity, cP	Durometer Hardness	Tensile at Break, MPa [psi]	Modulus of Elasticity, MPa [psi]	Halogen Free?
9671	UV/Visible light cure; bright red color; high adhesion to LCP, voice coil; thick viscosity for easy application	45,000	D55	15.8 [2,100]	179.2 [26,000]	Not Tested
9671-GEL		135,000			193 [26,000]	
3013	UV/Visible light cure; fluorescing for easy inspection; moisture resistant; other viscosities available	150	D70	18 [2,400]	350 [50,000]	

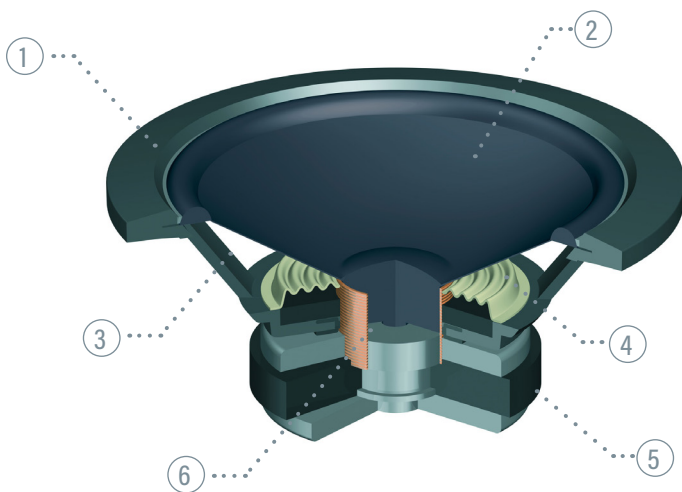

TYPICAL SPEAKER COMPONENTS

1. Suspension
2. Cone
3. Basket
4. Spider
5. Magnet
6. Voice Coil

Ruggedizing/Edgebond Materials for BGAs & VGAs

Dymax component ruggedizing and staking materials are engineered to hold critical components, such as Ball Grid Arrays (BGA) and Video Graphics Arrays (VGA), for secondary processes or long-term reliability. Should one ball-grid interconnect fail, an entire device could be compromised. UV light-curable ruggedizing materials help enhance the shock and vibration resistance of electronic assemblies.

As an alternative to underfill or heat-cured epoxies, light-curable adhesives offer a range of benefits including:

- Fast, ambient dispense and cure in seconds
- Easy rework – adhesive leaves no residue on solder pads or between solder balls
- Reduced stress on interconnects during push, pull, shock, drop, and vibration
- Enhance PCB life span
- Eliminate leadless component (BGA/VGA) interconnect cracking due to CTE mismatch
- Post reflow application
- Simple visual inspection

Product Number	Features	Viscosity, cP	Durometer Hardness	Tensile at Break, MPa [psi]	Modulus of Elasticity, MPa [psi]	Halogen Free?
9309-SC	UV/Visible light cure; formulated with See-Cure technology; high viscosity; highly thixotropic material	45,000	D57	22 [3,200]	163 [23,800]	

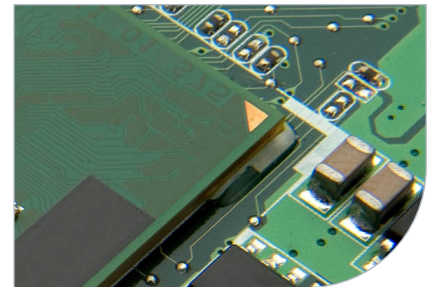
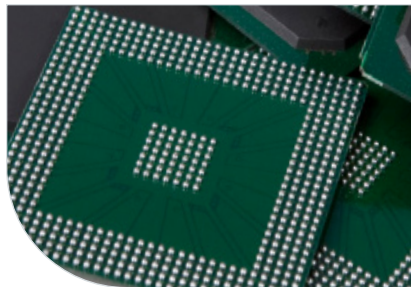
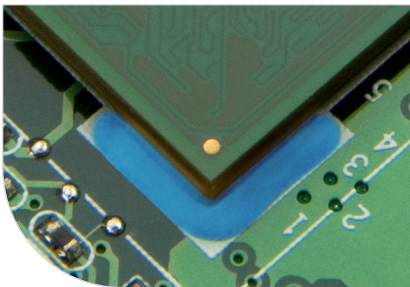

 Featured Product



SpeedMask® Temporary Masking Resins

Superior Protection of Printed Circuit Board Components During Processing

Protect connectors and board-level areas during processing with SpeedMask® masking resins. The masks provide reliable, one-layer protection during wave solder and reflow processes, as well as during conformal coating with both solvent-based and light-cure coatings. The masks cure in seconds and are easily removed by peeling.

Product Number	Features	Viscosity, cP	Durometer Hardness	Tensile at Break, MPa [psi]	Modulus of Elasticity, MPa [psi]	Halogen Free?
9-20479-B-REV-A	Ideal for masking board pins and connectors; compatible with gold and copper pins; blue color; thixotropic for manual or automated dispense	115,000	A75	3.37 [490]	4.13 [600]	
9-7001	Ideal for masking PCB keep-out areas and connectors; pink color in uncured state; compatible with gold and copper pins; resistant to solvent-based conformal coatings and primers	40,000	A70	3.8 [560]	1.9 [275]	
9-318-F	Highly thixotropic for manual or automated dispensing; silicone free; very low VOCs; blue fluorescing	50,000	A55	3 [440]	2 [310]	

 Featured Product

Protection of Parts During Handling and Surface Treatments

SpeedMask® masking resins are ideal for protecting delicate surfaces from scratching or other damage during handling or protecting parts during more aggressive surface treatments like anodizing, machining, and polishing. The masks are available in highly visible colors, making it easy to confirm placement. They cure in seconds, allowing the part to be processed immediately. After processing, the masks are easily removed from non-porous surfaces, leaving no residue behind.

Product Number	Features	Viscosity, cP	Durometer Hardness	Tensile at Break, MPa [psi]	Modulus of Elasticity, MPa [psi]
726-SC	See-Cure blue-to-pink color change technology; spray or dip; easy peel after exposure to heat	52,000	D40	6.8 [980]	3.9 [560]
728-G-LV	Ideal for machining and polishing processes; high-visibility green color; easy peel off after hot water soak; spray or dip dispense options; acid resistant	2,500	D50	23.4 [3,400]	293 [42,500]
730-BT	Excellent surface protection and chemical resistance during anodizing; moderate adhesion; spray or dip; trimmable after cure; high-visibility blue color	22,000	D35	3.4 [700]	3.4 [500]

 Featured Product



Typical Masking Applications

- 1. Masking PCB components and keep-out areas before conformal coating, wave solder, or reflow processes
- 2. Masking housing before painting, coating, or anodizing
- 3. Protect surface while engraving logos and other items or when machining out areas for buttons, speakers, and cameras
- 4. Mask off delicate parts to protect them from buffing/polishing or handling

Materials for Wearable Device Assembly

Designed for Close Proximity to Skin

Dymax 9200-W series adhesives are designed for the assembly of wearable consumer (non medical) electronic devices where materials of concern and proximity to skin matter. We have intentionally removed potential skin sensitizers like IBOA (isobornyl acrylate) or materials of concern to make our materials wearable-friendly without compromising trusted quality and high performance. This series includes materials for encapsulation, optical positioning, sealing, bonding, and general assembly.

Product Number	Features	Cure Mechanism	Substrates	Viscosity, cP	Durometer Hardness	Water Absorption, % (25°C, 24h)	Tensile at Break, MPa [psi]	Modulus of Elasticity, MPa [psi]	Halogen Free?
9201-W	IBOA-free encapsulant; moisture, thermal, and impact resistance; ideal for chip on board, chip on flex, or wire bond encapsulation; excellent component protection against chemical or environmental exposure	UV broad spectrum; UV LED 365 nm; Moisture cure	ABS, FR4, PA, PI, PET, TPU	32,000	D20-D40	0.13	11.1 [1,614]	322 [46,790]	
9202-W	IBOA-free positioning adhesive; low shrinkage and outgassing; moisture resistance; low CTE; designed for optical alignment and lens positioning	UV broad spectrum; UV LED 405 nm;	PC, PET, PMMA, Glass, SS	260,000	D88	0.14	35.9 [5,200]	4,214 [611,150]	
9210-W	IBOA-free encapsulant; moisture resistance; great reliability testing performance; ideal for component encapsulation, FPC reinforcement, & selective protection	UV broad spectrum; Moisture cure	FR4, PA, PI	29,000	D55-D75	0.13	15.3 [2,222]	561 [81,369]	
9211-W	IBOA-free plastic bonder; low stress; ideal for CCM barrel and holder assembly; adheres to a wide range of plastics	UV broad spectrum	ABS, FR4, LCP, PA6, PC, PET, PETG, PI, PU, TPU	20,000	D63	2.98	16.4 [2,378]	700 [101,540]	





Smart Watch

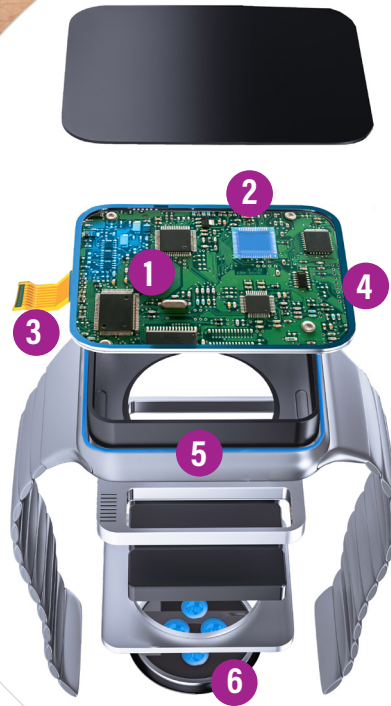

9200-W Series Adhesives Application Areas

1. Selective coating or environmental protection
2. Component encapsulation
3. FPC reinforcement
4. Assembly & sealing enclosures
5. Structural bonding
6. Sensor encapsulation

Applicable Devices

- VR goggles & smart glasses
- Headbands
- Headphones & earbuds
- Smartwatches
- Smart garments
- Biomechanical shoe inserts
- Smart rings
- Fitness belts & trackers

Innovative Technologies

As an innovator in the adhesive and coating industries, Dymax strives to create new technologies that help manufacturers increase process efficiency, productivity, and throughput while decreasing costs and inventory. Through the years, our dedication to innovation has resulted in over 30 patents and numerous awards for our innovative technologies and service.

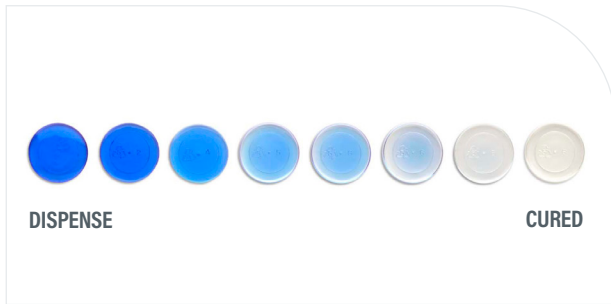

See-Cure Technology Confirm Adhesive Placement & Cure

- Material transitions color when cure is complete
- Provides critical safety feature for manufacturing processes
- Simple visual confirmation of cure, no special equipment needed

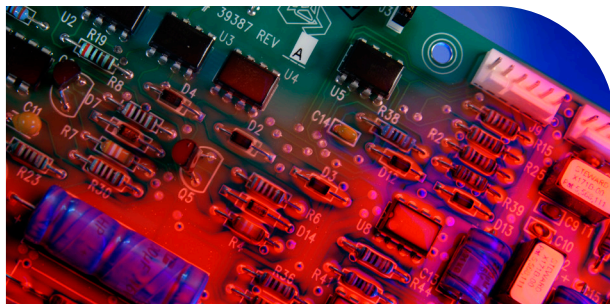

Ultra-Red® Technology Enhance Bond-Line Inspection

- Fluoresces bright red when exposed to low-intensity black light so bond lines can be easily inspected
- Produces a unique energy peak exclusive to Dymax so products can be marked and positively identified

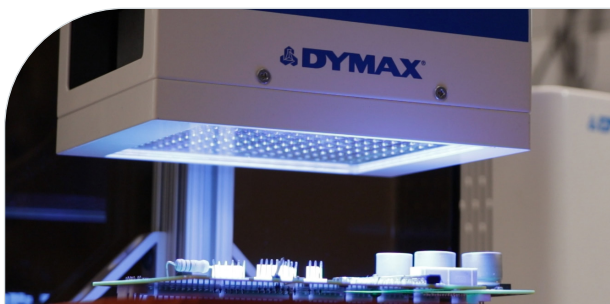

LED Light-Cure Materials & Equipment Green, High Throughput Assembly Solutions

- Super fast, uniform cures for higher efficiency
- Cooler curing temperatures for heat-sensitive substrates
- Greener technology -high electrical efficiency and no mercury or ozone safety risks

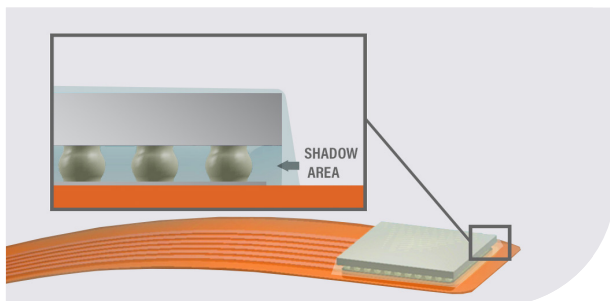

Dual-Cure & Multi-Cure® Technology Eliminate Uncured Material in Shadow Areas

- Cures with light but features secondary moisture cure (dual-cure Technology) or heat cure (Multi-Cure Technology) for material that flows into shadow areas

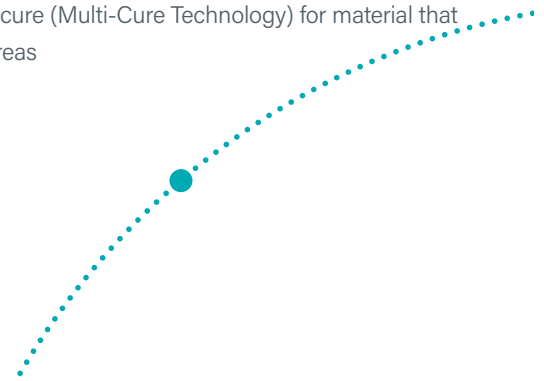

Dispensing & Curing Equipment

Dymax offers a wide range of curing equipment including various spot lamps, flood lamps, and conveyor systems, as well as radiometers and other accessories. Since Dymax designs and manufactures its own lamp systems, the lamps are optimized to work with the adhesives to gain process efficiencies by targeting rapid surface curing, depth of cure, and speed of cure, all while delivering light in a rapid and economical way. CE marked equipment is available.

Dispensing Systems

Our Application Engineering lab can assist manufacturers with integrating the appropriate manual and robotic dispensing systems into their production lines.

Spot Lamps

Spot lamps provide a wide variety of methods to deliver light to a very precise location. They can be used manually by an operator or incorporated into a high-speed automated assembly line. Dymax offers multi-spectrum light-emitting lamps which use high-pressure mercury vapor bulbs, as well as light-emitting diode spot lamps, which use an array of surface-mounted LEDs instead of traditional metal halide or mercury bulbs.

Radiometers

Measurement of the lamp intensity and dosage is critical to the successful implementation of light-curing technology. Dymax radiometers allow operators to monitor and document a light-curing process.

Flood Lamps

Static flood lamp systems are suited for area curing or for curing multiple assemblies. They use moderate- to high-intensity, multi-spectrum UV/Visible light for fast curing. Light-curing flood lamps can be easily integrated into existing manufacturing processes by mounting the lamps above high-speed assembly lines to achieve rapid cures. Shutter assemblies, mounting stands, and shields are available to create a custom curing system.

Conveyor Systems

Conveyor systems consist of a moving belt that passes through a curing tunnel with multi-spectrum lamps mounted from above or on each side for fast curing of parts. These conveyor systems are designed to offer consistent, fast, and safe curing. They can be outfitted with standard metal halide (longwave UV), mercury (shortwave UV), or visible bulbs. Consistent line speed, lamp height, and intensity provide a consistent light-curing process for high throughput.

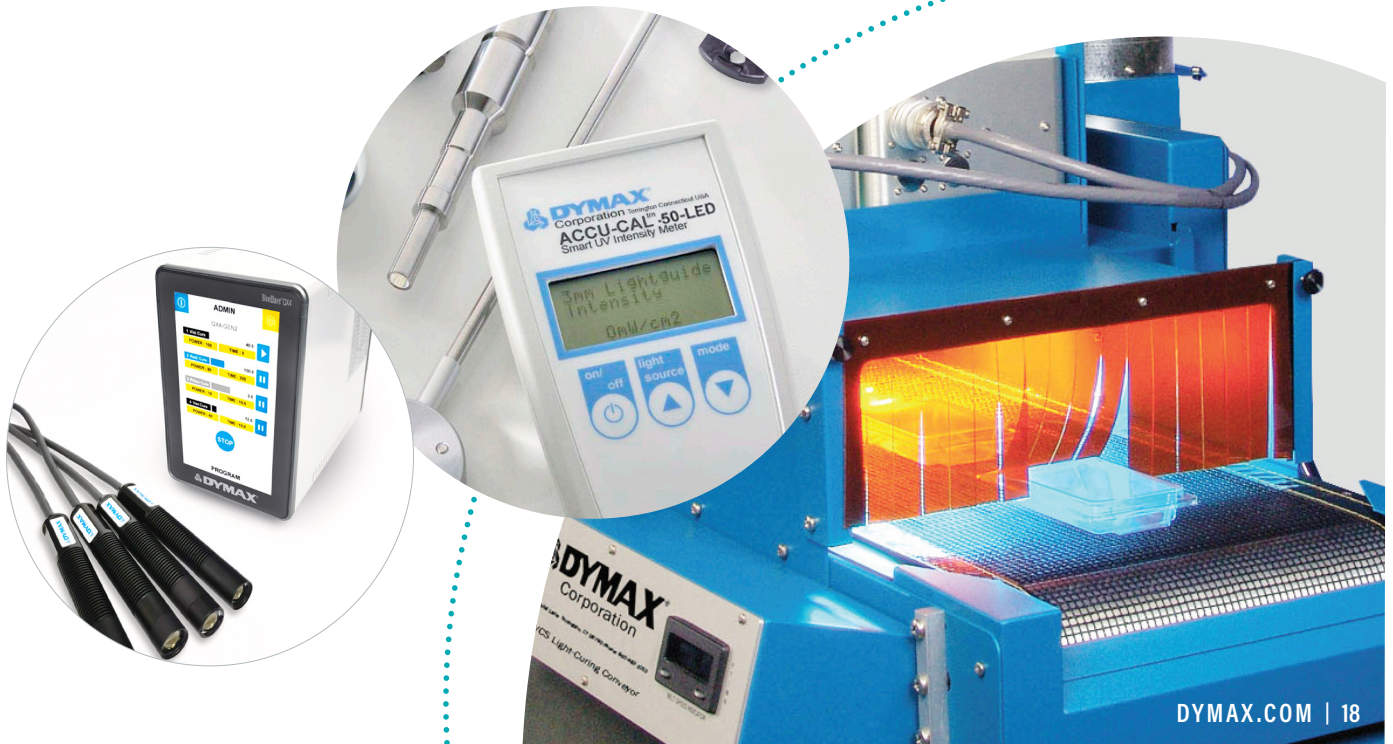



www.dymax.com

Americas

USA | +1.860.482.1010 | info@dymax.com

Europe

Germany | +49 611.962.7900 | info_de@dymax.com

Ireland | +353 21.237.3016 | info_ie@dymax.com

Asia

Singapore | +65.67522887 | info_ap@dymax.com

Shenzhen | +86.755.83485759 | info@hanarey.com

Hong Kong | +852.2460.7038 | dymaxasia@dymax.com

Korea | +82.31.608.3434 | info_kr@dymax.com