

Dymax BlueWave® LED DX-1000 VisiCure® User Guide

Small-Area LED Light Source

- Instructions for Safe Use
- Setup and Operation
- Maintenance
- Ordering Spare Parts and Accessories



About Dymax**UV/Visible light-curable adhesives. Systems for light curing, fluid dispensing, and fluid packaging.**

Dymax manufactures industrial adhesives, light-curable adhesives, epoxy resins, cyanoacrylates, and activator-cured adhesives. We also manufacture a complete line of manual fluid dispensing systems, automatic fluid dispensing systems, and light-curing systems. Light-curing systems include LED light sources, spot, flood, and conveyor systems designed for compatibility and high performance with Dymax adhesives.

Dymax adhesives and light-curing systems optimize the speed of automated assembly, allow for 100% in-line inspection, and increase throughput. System designs enable stand-alone configuration or integration into your existing assembly line.

Please note that most dispensing and curing system applications are unique. Dymax does not warrant the fitness of the product for the intended application. Any warranty applicable to the product, its application, and use is strictly limited to that contained in the Dymax standard Conditions of Sale. Dymax recommends that any intended application be evaluated and tested by the user to ensure that desired performance criteria are satisfied. Dymax is willing to assist users in their performance testing and evaluation by offering equipment trial rental and leasing programs to assist in such testing and evaluations. Data sheets are available for valve controllers or pressure pots upon request.

Contents

Introduction	4
Introduction to the User Guide	4
Where to Get Help	4
Safety	4
Specific Safety Considerations.....	5
Dymax Light-Curing System Safety Considerations	5
Product Overview	7
Description of the <i>BlueWave LED DX-1000 VisiCure</i>	7
Special Features and Benefits of the <i>BlueWave LED DX-1000 VisiCure</i> System	8
Intensity Control Feature	8
Validation	9
Front Control Panel	10
Back Panel	11
Assembly and Setup	12
Unpacking and Inspecting Your Shipment.....	12
Parts Included in the <i>BlueWave LED DX-1000 VisiCure</i> Small-Area LED Light Source	12
System Connections	14
Operating the LED Light	15
Powering up the Controller	15
Using Advanced and Optional Features	16
Using the Optional Stand.....	16
Using the PLC Interface	17
System Cleaning	19
Error Codes and Troubleshooting	21
Spare Parts and Accessories	23
Options/Accessories	23
Specifications	25
Packages	25
Specifications.....	25
Warranty	27
Index	27

Introduction

Introduction to the User Guide

This guide describes how to assemble, use, and maintain the Dymax BlueWave® LED DX-1000 VisiCure® Small-Area LED Light Source safely and efficiently.

Intended Audience

Dymax prepared this user guide for experienced process engineers, technicians, and manufacturing personnel. If you are new to high-intensity LED light-curing systems and do not understand the instructions, contact Dymax Application Engineering to answer your questions before using the equipment.

Where to Get Help

Dymax Customer Support and Application Engineering teams are available in the United States, Monday through Friday, from 8:00 a.m. to 5:30 p.m. Eastern Standard Time. You can also email Dymax at info@dymax.com. Contact information for additional Dymax locations can be found on the back cover of this user guide.

Additional resources are available to ensure a trouble-free experience with our products:

- Detailed product information on www.dymax.com
- Dymax adhesive Product Data Sheets (PDS) on our website
- Material Safety Data Sheets (MSDS) provided with shipments of Dymax adhesives

Safety

Before continuing with the installation, please read the following chapters of this manual for safety recommendations and installation, operation, and troubleshooting instructions.



CAUTION! Always wear protective goggles or face shield when working near the front of the unit, which emits high-intensity visible light!



WARNING! Always observe safety requirements!



CAUTION! Risk of electrical shock if cover is removed!

To use a BlueWave LED VisiCure system safely, it must be set up and operated in accordance with the instructions given by Dymax. Using the system in any other manner will impair the protection of the system. Dymax assumes no liability for any changes that may impair the protection of the BlueWave LED VisiCure system.

Safety Recommendations

- Use the goggles provided or an approved face shield for eye/face protection.

- Long-sleeved shirts or a lab coat are recommended for arm protection. The use of opaque gloves will protect the hands.

NOTE: The BlueWave LED VisiCure emits high-intensity light. Never look directly at the light-emitting end of the lightguide while the unit power is on.

To learn about the safe handling and use of light-curable formulations, obtain and read the MSDS for each product. Dymax includes an MSDS with each adhesive sold. In addition, fluid product MSDS can be requested through the Dymax website.

Specific Safety Considerations

The *BlueWave LED DX-1000 VisiCure* is designed to maximize operator safety and minimize exposure to light-curing energy. To use the unit safely, it must be set up and operated in accordance with the instructions in this user guide. Please also read and understand the safety considerations unique to LED-curing systems as described below.



WARNINGS! *Looking directly at the high-intensity light emitted by the BlueWave LED DX-1000 VisiCure can result in eye injury. To prevent eye injury, never look directly at the high-intensity light and always wear protective goggles (provided).*

Operating the light with the Lens Cover in place can result in overheating and equipment damage. To prevent equipment damage, never operate the unit with the Lens Cover in place.

Removing the cover from the BlueWave LED DX-1000 Controller can result in electrical shock. To prevent electrical shock, never remove the cover from the DX-1000 Controller.

If you block the air flow from the LED Irradiator Head or Controller Cooling Fans, equipment damage and malfunction can result. To prevent damage and malfunction, ensure there is adequate space at the Cooling Fan Outlets to allow the free flow of air.

Dymax Light-Curing System Safety Considerations

Operators must understand these three concepts to use the LED light source safely: light exposure, high-temperature surfaces, and bright, visible light. Each is described below.

Light Exposure

Standard Dymax VisiCure systems have been designed to primarily emit visible light (as shown in Figure 1). Although OSHA does not currently regulate visible or ultraviolet-light exposure in the workplace, the American Conference of Governmental Industrial Hygienists (ACGIH) does recommend Threshold Limit Values (TLV's) for ultraviolet light. The strictest interpretation of the TLV (over the UVA range) for workers' eyes and skin is 1 mW/cm² (intensity), continuous exposure. Unless workers are placing bare hands into the curing area, it is unusual to exceed these limits. To put the 1 mW/cm² limit into perspective, cloudless summer days in Connecticut regularly exceed 3 mW/cm² of UVA light, which includes the more dangerous UVB light, primarily responsible for sun tans, sun burns, and skin cancer.

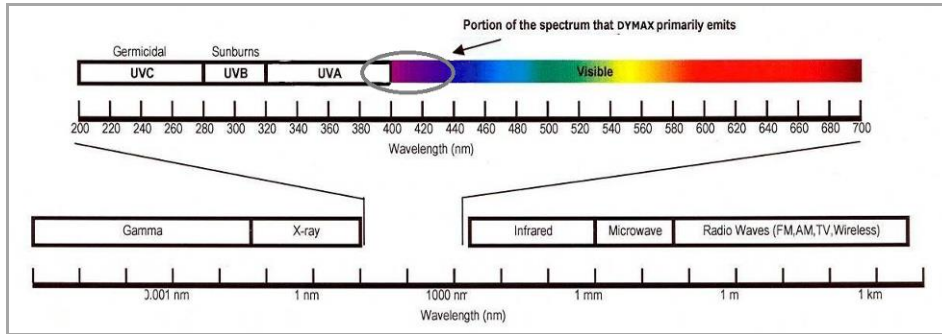
Figure 1. Light Spectrum

Checking the Workstation

A radiometer should be used to measure stray light to confirm the safety of a visible light-curing process. A workstation that continuously exposes an operator to more than 1 mW/cm² of UVA light should be redesigned.

Protecting Operators

Light-curing technology can be a regulatory compliant, "worker-friendly" manufacturing process when the proper safety equipment and operator training is utilized. There are two ways to protect operators from visible light exposure: shield the operator and/or shield the source.

Shield the Operator

Tinted eyewear will shield the operator from high intensity visible energy, and reduce eye fatigue.

Shield the Source of the Light

Any substrate that blocks Visible light can be used as a shield to protect workers from stray light. The following materials can be used to create simple shielding structures:

Sheet Metal – Aluminum, steel, stainless steel, etc. Sheet metal should be coated black or black anodized to minimize reflection of UV and visible light toward operators.

Rigid Plastic Film – Transparent or translucent/light-blocking plastics (typically polycarbonate or acrylic) are commonly used to create shielding where some level of transparency is also desired.

Flexible Film – Translucent light-blocking, flexible urethane films can be used to quickly create workstation shielding. This light-blocking, flexible urethane film is available from Dymax. Call for assistance.

High-Temperature Surfaces

Surfaces exposed to high-intensity curing lights may rise in temperature. The intensity, distance, exposure time, cooling fans, and composition of the surface can all affect the rise in surface temperature. In some cases, exposed surfaces can reach temperatures capable of producing a burn or causing damage to a substrate. In these cases, care must be taken to ensure either a more moderate surface temperature or appropriate protection/training for operators. No infrared radiation is produced by these LED systems, so surface temperatures will be lower than with conventional lamp systems. Empirical testing should be used to verify the exact temperature rise in each application.

Bright, Visible Light

The bright, visible light energy emitted by curing systems can cause eye strain if proper eye protection or shielding is not used. The proper use of tinted eye protection and/or opaque/tinted shielding can be utilized to reduce eye strain and address this concern.

Product Overview

Description of the *BlueWave LED DX-1000 VisiCure*

The *BlueWave LED DX-1000 VisiCure* is a high-intensity light-curing system used for curing adhesives, coatings, and potting materials. You can mount and integrate the unit into automated manufacturing systems or, using the optional stand, conveniently mount and use the unit on a bench top.

The *BlueWave LED DX-1000 VisiCure* consists of two main components: a Controller that contains the User Interface and Power Supply, and an LED Irradiator Head. A cable connects the two components (Figure 2).

The unit can be operated in timed or manual modes. The output intensity level can be adjusted from 0 to 100% to meet process and adhesive requirements. The *BlueWave LED DX-1000 VisiCure* is rated for continuous operation.

Fans in the Controller and Irradiator Head provide cooling and must not be covered or blocked. Fan Filters must be maintained regularly to ensure reliable operation.

Thermal Sensors in the Controller and Irradiator Head shut the unit down to protect the components if the internal temperature exceeds maximum limits.

Figure 2. Main Components of a *BlueWave LED DX-1000 VisiCure*

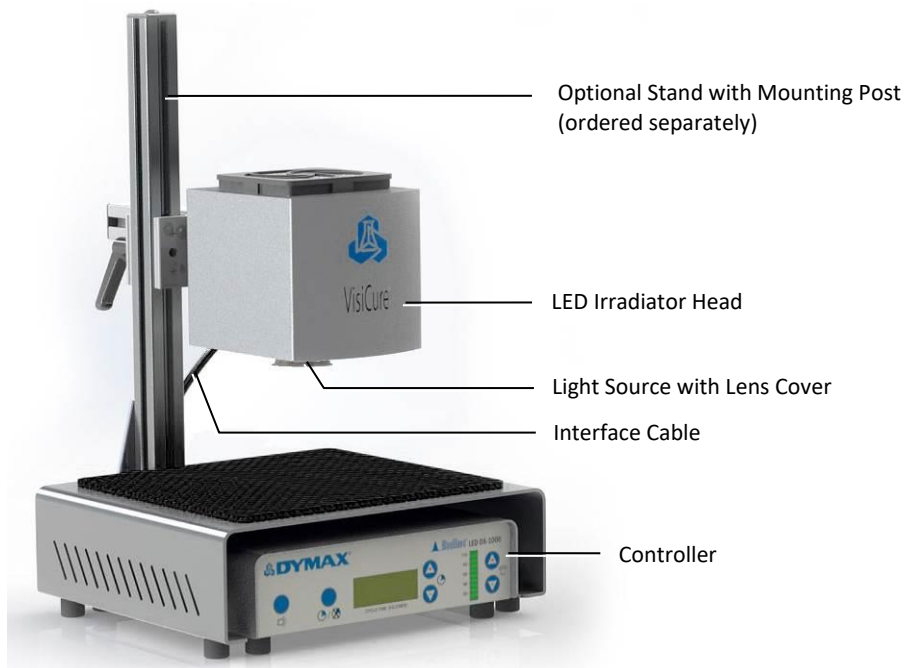

Special Features and Benefits of the *BlueWave LED DX-1000 VisiCure* System

The Dymax *BlueWave LED DX-1000 VisiCure* is engineered for precise performance and long service life. Key features include:

Feature	Benefit
Curing area up to 1" x 1.5" [2.54 cm x 3.81 cm]	Area-cure capability with LED
Flexible mounting options	Adaptable to a variety of process and fixture scenarios
100% duty cycle capability	Highest throughput (exposure cycles "at the speed of light")
No mechanical shutter	Instant on/Instant off exposures
Intensity output adjustment (5 to 100%)	Superior accuracy over "closed loop feedback" or auto-adjusting units
	Optimum process control
405 nm LED	High photo-initiator sensitivity
Co-optimized to cure with Dymax formulations	Compatibility with many formulations
	Fewer re-qualifications
Multiple energy delivery configurations	Direct emission
	Lightguide
	Multi-lens optical stacks
Stable LED temperature	Optimizes cure time efficiency
	Increases LED life
LED	Superior LED cooling for consistent frequency output
	Longer LED life via reduced intensity degradation

Intensity Control Feature

The components used in all light-curing systems degrade with use. Therefore, the maximum intensity decreases as exposure hours accumulate. Setting process intensity requirements lower than the maximum enables the *BlueWave LED DX-1000 VisiCure's* Intensity Control Feature to allow for compensation of gradual decreases in light intensity.

The unit's intensity can be adjusted using the Intensity Control Feature (Figure 3) on the Front Control Panel. The intensity adjustment is software controlled and allows for control of output intensity. The ten LED Power Level Bars correlate to 10% increments of the total available power. Pressing the up button (▲) increases the light intensity in 1% increments. Pressing the down button (▼) decreases the light intensity in 1% increments. As the power level is adjusted, the Cycle Time Display changes and displays the power level percentage. Adjustment of the power setting is done while in manual mode and is not possible while running a timed exposure.

Use a Radiometer to correlate the percent power output to a reading in W/cm^2 . The adjustment of power level and correlation to a light-intensity value (W/cm^2) enables precise control of light intensity during validation and operation.

Figure 3. Intensity Control Feature on the *BlueWave LED DX-1000 VisiCure*

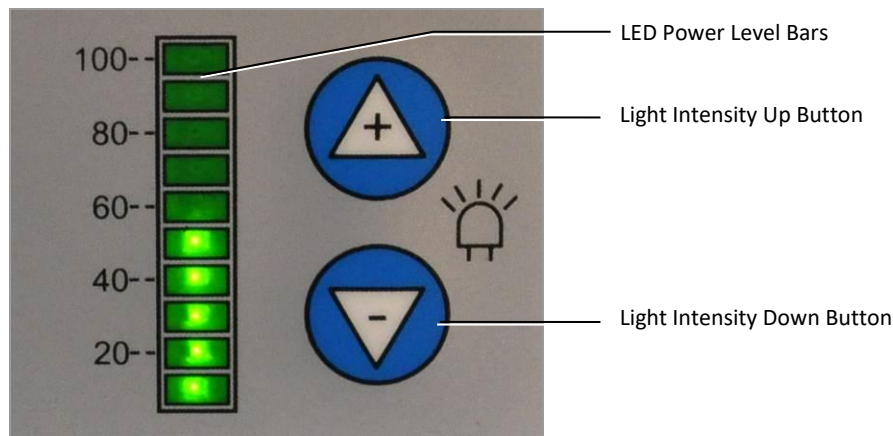

Validation

Tests should be conducted prior to production to determine the time and light intensity required to fully cure your resin. The following approaches may be used to validate the curing process.

Set Exposure Time, Determine Intensity

Users can specify a cure time, and through empirical testing, determine the intensity required to achieve a full cure. As with any manufacturing process, it is advisable to incorporate a safety factor.

Set Intensity, Determine Exposure Time

Users can specify light intensity and through empirical testing, determine the exposure time required to achieve a full cure. As with any manufacturing process, it is advisable to incorporate a safety factor.

Control

Process validation confirms a minimum acceptable intensity. Users can then choose to operate at full intensity (using the excess intensity as an additional safety factor) or adjust the output to a specific intensity level. To ensure consistent and repeatable process results, intensity levels should be monitored with a Radiometer. This enables users to identify light intensity changes and take corrective action: either adjusting the light intensity or performing maintenance.

Front Control Panel

In addition to the Light Intensity Control Feature, the Front Control Panel (Figure 4) includes:

- **Run/Stop Button** — Pressing this button starts a curing cycle. In timed operation, pressing and releasing the Run/Stop Button illuminates the curing light for the length of time displayed in the Cycle Time Display. A second press will stop the cure cycle immediately. In manual operation, pressing and holding the Run/Stop Button illuminates the curing light until the button is released. The curing light illuminates until the cycle time is reached.
- **Timed/Manual Button** — Pressing this button toggles between manual and automatic operation. In timed operation, pressing the Run/Stop Button illuminates the curing light for the length of time displayed in the Cycle Time Display. In manual operation, the Cycle Time Display changes to a series of dashes and the curing light remains illuminated as long as the Run/Stop Button is depressed.
- **Cycle Time Display** — This LED display indicates the current cycle time. It also displays the light intensity percentage when light intensity is adjusted. It also will display error codes if an operating error occurs.
- **Cycle Time Adjustment Buttons** — Pressing these buttons increases or decreases the cycle time. Hold the button in to increase the speed at which the value changes.
- **Intensity Control Feature** — Enables manual control of the light intensity (see *Intensity Control Feature* on page 8). Pressing the + or – button momentarily will change the display to show the current setting in %, holding the button will increase or decrease the setting and the display will show the set level as it is adjusted.
- **Operating Time Log** (unit operation and exposure hours (non re-settable)) — This display is only visible when both the + and – time buttons are pressed and held simultaneously for 5 seconds. The display will indicate in hours the accumulated run time of the LED first and then the Controller second.

Figure 4. Front Control Panel

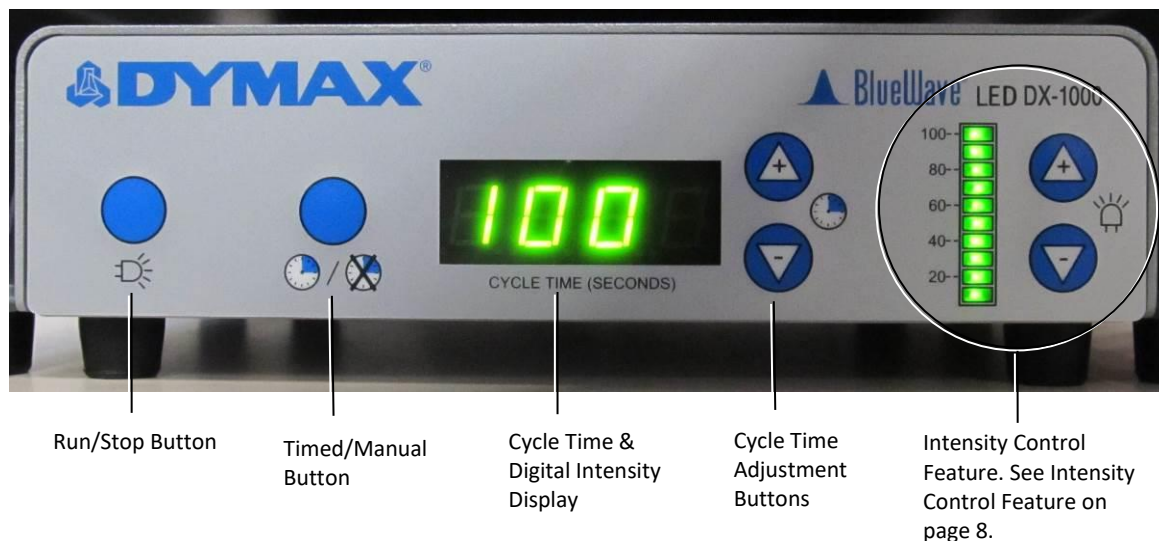

Back Panel

The Back Panel (Figure 5) includes these components and connection points:

- **Power Cord Receptacle** — Connection point for the Power Cord.
- **I/O (On/Off) Switch** — Moving the switch to the I (on) position powers up the Controller. Moving the switch to the O (off) position cuts power to the Controller.
- **Cooling Air Intake** — Cooling air enters the Rear Intake, which includes a replaceable Filter. NOTE: The exhaust vents located on the side of the enclosure must not be blocked or the unit may overheat and shutdown.
- **Footswitch Jack** — Connection point for the Footswitch. Pressing the Footswitch starts a curing cycle. In timed operation, pressing and releasing the Footswitch illuminates the Curing Light for the length of time displayed in the Cycle Time Display. A second press will terminate a timed cure cycle immediately. In manual operation, pressing and holding the Footswitch illuminates the Curing Light until the Footswitch is released.
- **PLC Connector** — Connection point for a user-supplied cable to connect the unit to a PLC for remote operation. Connection is a standard 15-Pin D-Style Connector. Refer to page 19 for details on the connections to this port.
- **Irradiator Head Cable Connector** — Connection point for the Power Cable connecting the Controller to the Irradiator Head.

Figure 5. Back Panel Controls and Connections

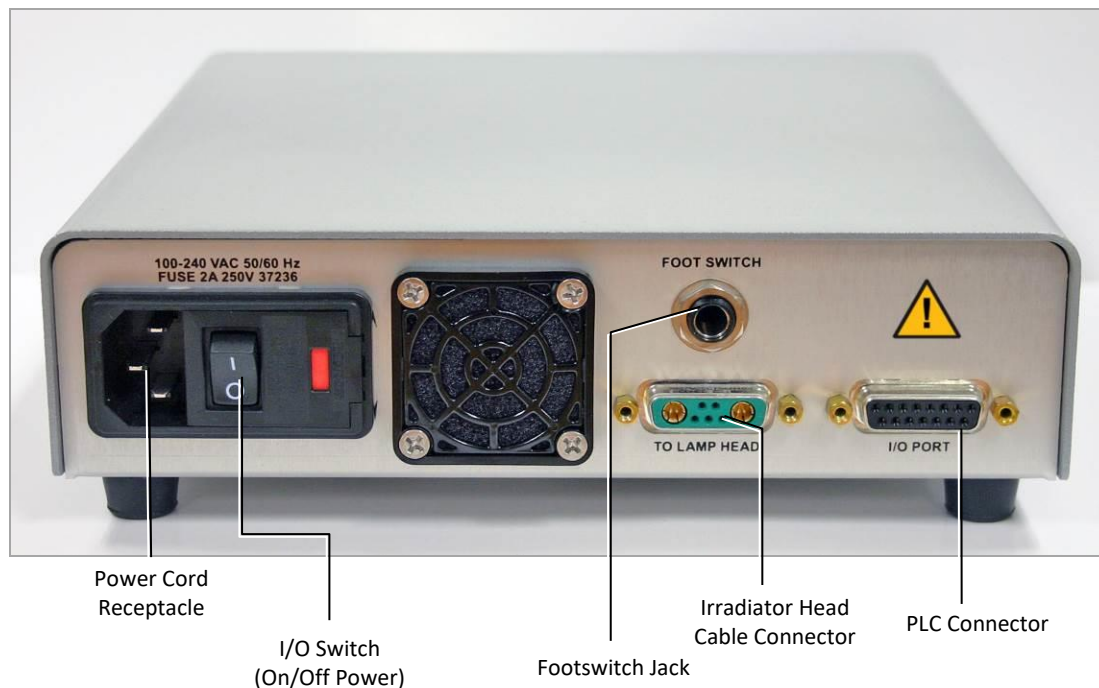

Assembly and Setup

Unpacking and Inspecting Your Shipment

When your *BlueWave LED DX-1000 VisiCure* arrives, inspect any boxes for damage and notify the shipper of box damage immediately.

Open each box and check for equipment damage. If parts are damaged, notify the shipper and submit a claim for the damaged parts. Contact Dymax so that new parts can be shipped to you immediately.

Check that the parts included in your order match those listed below. If parts are missing, contact your local Dymax representative or Dymax Customer Support to resolve the problem.

Parts Included in the *BlueWave LED DX-1000 VisiCure Small-Area LED Light Source*

The *BlueWave LED DX-1000 VisiCure* is available in four packages:

- **Base System:** For custom mounting and system integration (mount supplied by user)
- **Flood Lamp Package:** Includes all parts necessary for using this system as a small-area flood lamp
- **Spot Lamp Package:** Includes all parts necessary for using this system as a spot lamp
- **Lab Developer Package:** Includes all parts necessary for both spot and flood modes

Figure 6. *BlueWave LED DX-1000 VisiCure* Components

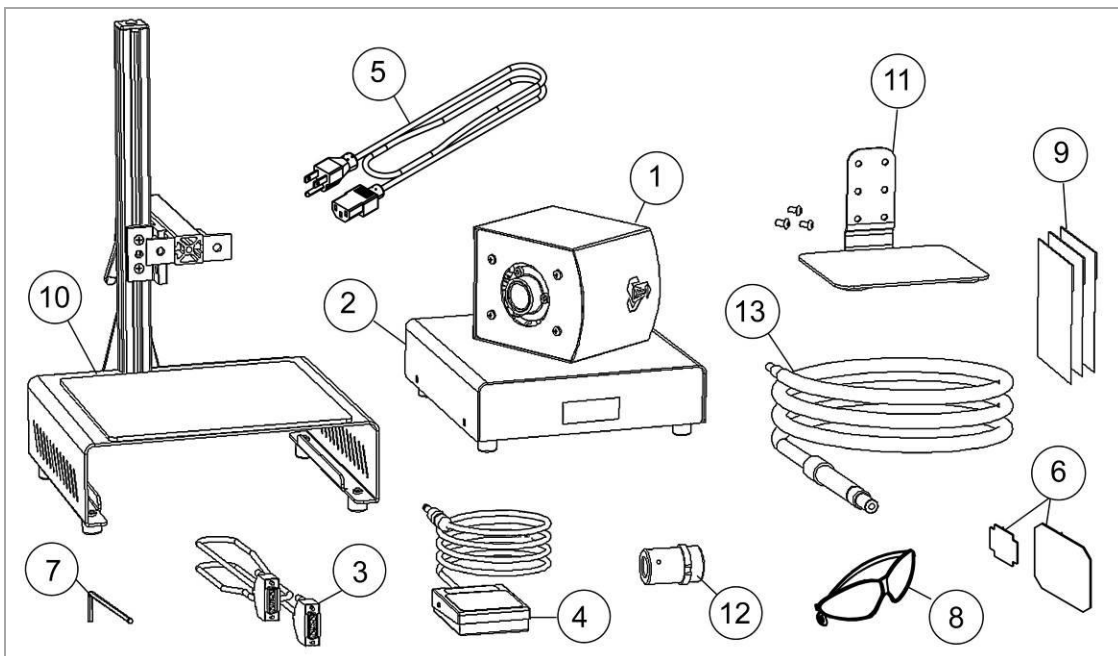

Table 1. Parts List

#	Part	Base System	Flood Mode Package	Spot Mode Package	Lab Developer Package
		41046	41047 41048 41049	41051 41052 41053	41055 41056 41057
1	Irradiator Head with Collimating Optic #1	✓	✓	✓	✓
2	Controller	✓	✓	✓	✓
3	Interface Cable - Choice of 3, 6, 10, or 19 in length	✓			
	Interface Cable – 19 in		✓	✓	✓
	Interface Cable – 3 in				✓
4	Footswitch	✓	✓	✓	✓
5	Power Cord*	✓	✓	✓	✓
6	Filter Media	✓	✓	✓	✓
7	Hex Key	✓	✓	✓	✓
8	UV Protection Goggles	✓	✓	✓	✓
9	3-PC Magnetic Flexible Shielding	✓	✓	✓	✓
10	Benchtop Stand and Work Platform		✓	✓	✓
11	Benchtop Base			✓	✓
12	Lightguide Adapter			✓	✓
13	Lightguide Mounting Stand			✓	✓
13	Lightguide, 5 mm x 1 M			✓	✓
	<i>BlueWave LED DX-1000 VisiCure</i> User Guide	✓	✓	✓	✓

* Dependent on model ordered. Some models do not include a power cord.

System Connections

Figure 7. Installing Cables on the Back Panel of the Controller



Figure 8. Attaching the Irradiator Head to the Optional Stand

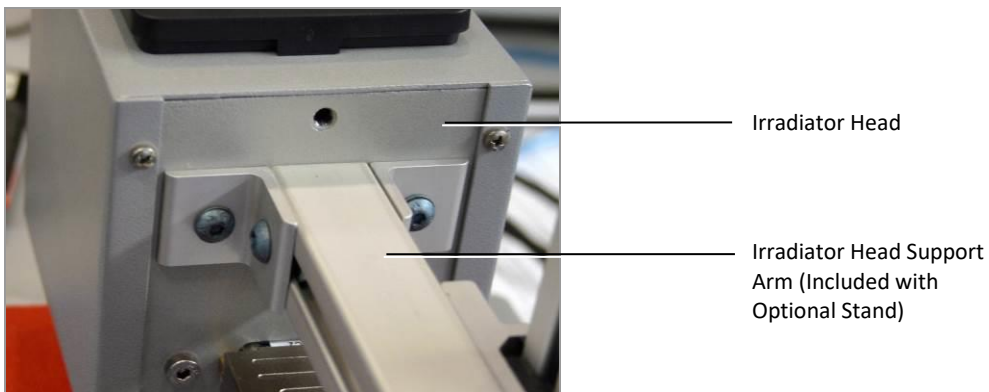
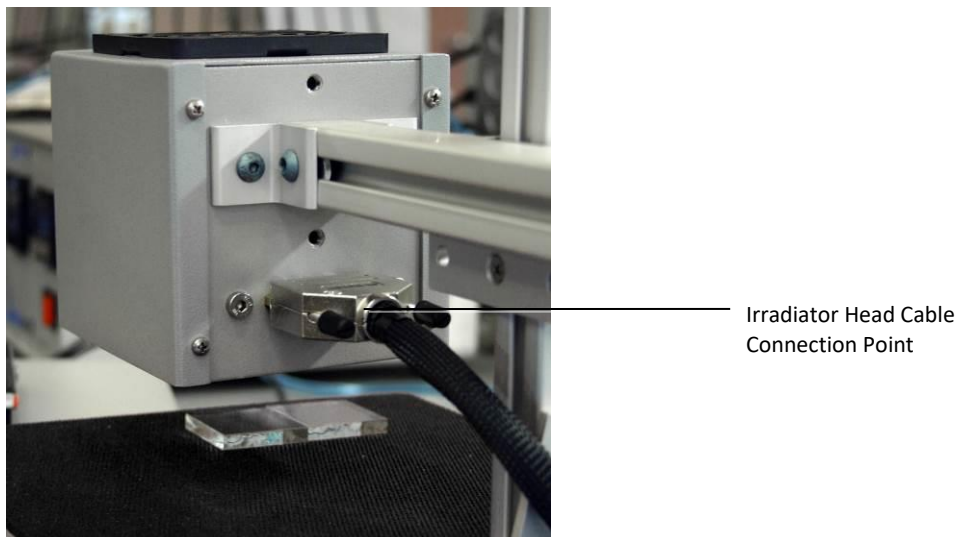

Figure 9. Installing Cable on the Irradiator Head



Operating the LED Light



WARNINGS! Looking directly at the high-intensity light emitted by the BlueWave LED DX-1000 VisiCure can result in eye injury. To prevent eye injury, never look directly at the high-intensity light and always wear protective goggles (provided).

Operating the light with the lens cover in place can result in overheating and equipment damage. To prevent equipment damage, never operate the unit with the lens cover in place.

Powering up the Controller

Follow these steps to operate the BlueWave LED DX-1000 VisiCure system:

1. Move the Power Switch on the Back Panel of the Controller to the On (I) position. The Power Supply and Timer are now operational.
2. Activate an exposure cycle by pressing the Footswitch or the Run Button on the Controller Front Panel (Figure 10).
3. In manual mode (all timer digits will be dashes), the exposure time is controlled directly from the Footswitch. In timed mode, operation is determined by the setting displayed on the Cycle Time Display.
4. To adjust the exposure time, push the Cycle Time Adjustment Buttons (Figure 10) to enter the desired number of seconds the LED needs to be powered. The up arrow (▲) increases the cycle (exposure) time in 0.1 second increments. Note that holding the up arrow increases the rate of change of the digits. The down arrow (▼) decreases the cycle (exposure) time in 0.1 second increments.
5. The output intensity can be adjusted from 5 to 100% in 1% increments using the light intensity up arrow (▲) or down arrow (▼). Press the Timed/Manual Mode Button to place the unit in manual mode and then adjust the intensity using the Intensity Adjustment Buttons. Output intensity cannot be adjusted in the timed mode.

Figure 10. Front Control Panel

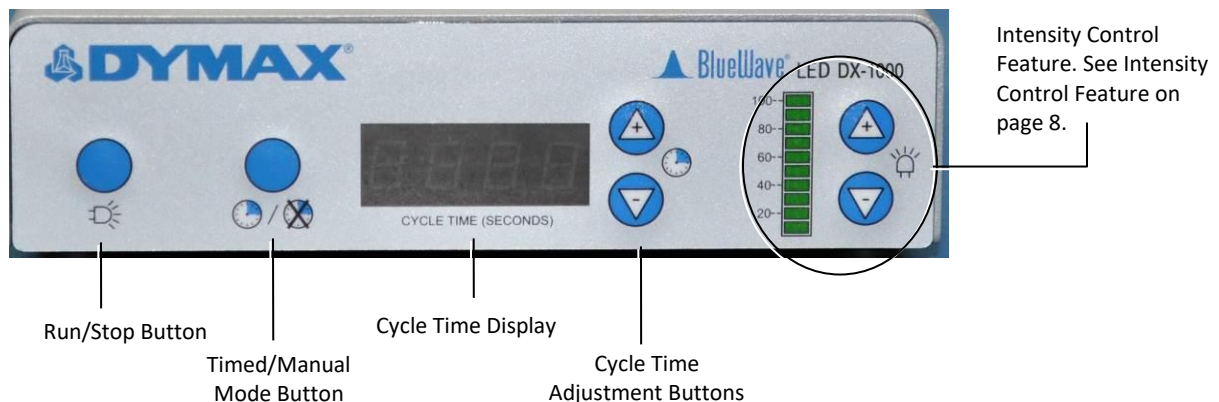

Using Advanced and Optional Features

Using the Optional Stand

You can purchase an optional stand that enables convenient and efficient use of the *BlueWave LED DX-1000 VisiCure* on a bench top.

To assemble and use the stand, follow these steps:

1. Attach the Upright to the Stand Base Unit using the Bracket and M6 hardware supplied (Figure 11).
2. Attach the Irradiator Head unit to the Irradiator Head Support Arm using the two M5 x 10 mm Mounting Screws and the 3 mm hex wrench.
3. Place the Stand Base Unit over the *BlueWave LED DX-1000 Controller*.
4. Adjust the height of the Irradiator Head Support Arm using the locking Height Adjustment handle on the Irradiator Head Support Arm (Figure 12).

Figure 11. Assembling the Optional Stand, Back View

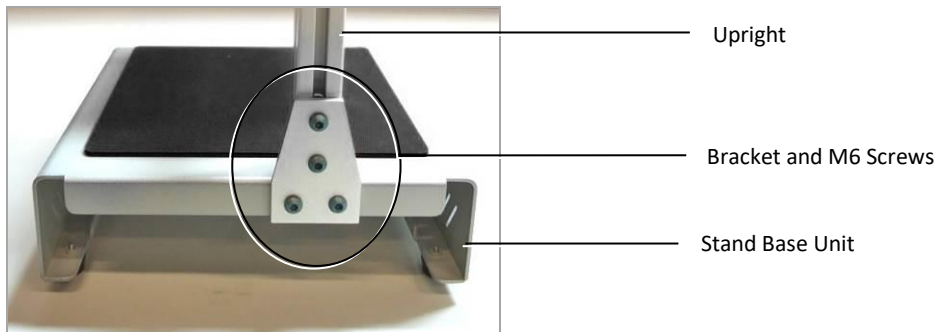
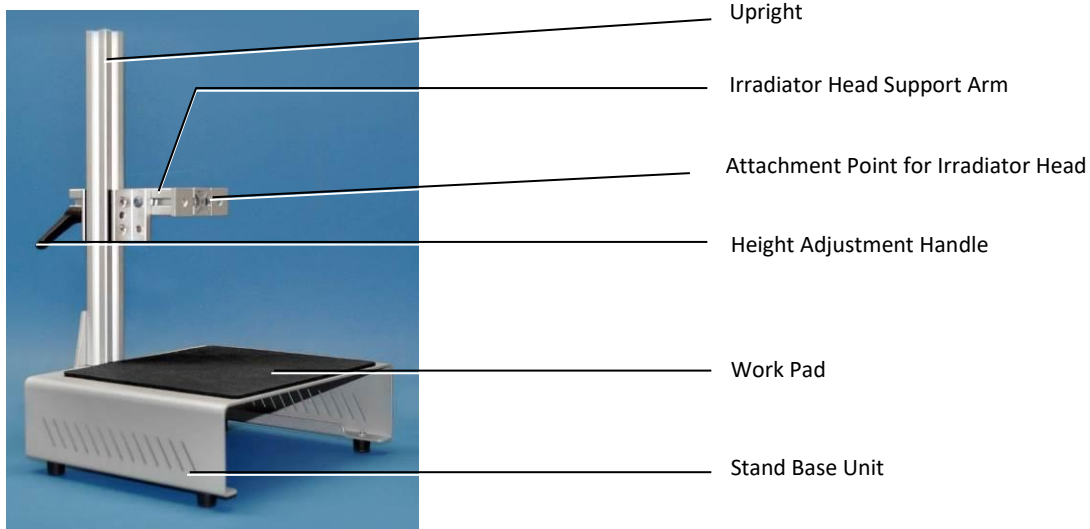

Figure 12. Assembling the Optional Stand



Using the PLC Interface

The *BlueWave LED DX-1000 VisiCure* includes a 15-Pin D-Subminiature Connector for communication with a PLC or similar process control equipment. The connector provides for input and output signals.

Table 2. Pinouts for 15-Pin D-Subminiature Connector on *BlueWave LED DX-1000 VisiCure*

Pin Number	Name	Description
1	+24V input	If this input is not present, ignore all PLC inputs and allow the outputs to run as usual.
2	Power supply and signal common	Return for all signals on the on the PLC.
3	Sleep input	With 24V applied, disables all functions on the Front Panel, Footswitch, and PLC Inputs. Shuts down the Fan completely after cooling the LED. Disables the LED Displays except for the Scrolling Display Panel to indicate sleep mode. If this signal is initiated during a cure cycle (duration >20 min.) the unit will terminate the current cure cycle and go into sleep mode.
4	Interlock input	Allows operation of the unit in the PLC mode only if this signal is present. If a safety switch is used then a failure (mode) in the switch or cables will terminate the operation of the unit.
5	Activate input	This Pin will work as the Run or Footswitch activation at the current intensity level (will be used for "simple" remote control of the unit when there is no desire to vary intensity) and place the unit in manual mode. The PLC will dictate cycle duration. The Cycle Time Display will indicate all dashes. When this signal is terminated the unit will remain in manual mode.
6	Intensity input	This is a PWM input used to set the LED intensity and describe a running set point. This input will work in conjunction with the Activate Input to enable operation. The PWM base frequency shall be 1 KHz. The duty cycle will dictate relative intensity.
7	Local disable input	When this Pin is asserted, the Footswitch and Run triggers will still be operational, but the Front Panel Controls will be "locked out" from the user. Activation can be accomplished but no adjustment to the mode of operation, set point of the LED intensity, or the timer setting will be possible. This will also prevent the ability to check system or LED operation hours.
8	Power on output	Asserted when the unit has correct AC voltage supplied and the internal supplies are within limits.
9	LED powered output	Asserted when the LED Power Supply is powered up, regardless of set point (5-100% power). This activation can be either Footswitch, Front Panel Button, or "Intensity In". <i>NOTE: Verification of LED illumination should be made visually to ensure proper operation.</i>
10	Intensity output	This is a PWM-based signal to drive the LED. It is a confirmation of operation for a given setting and as a relative indication of power level.
11	Fault output	This Pin is active when any critical fault conditions are met and the LED operation is inhibited.
12	Not used	
13	Not used	
14	Not used	
15	Not used	

Figure 13. Pinout Diagram for 15-Pin D-Subminiature Connector

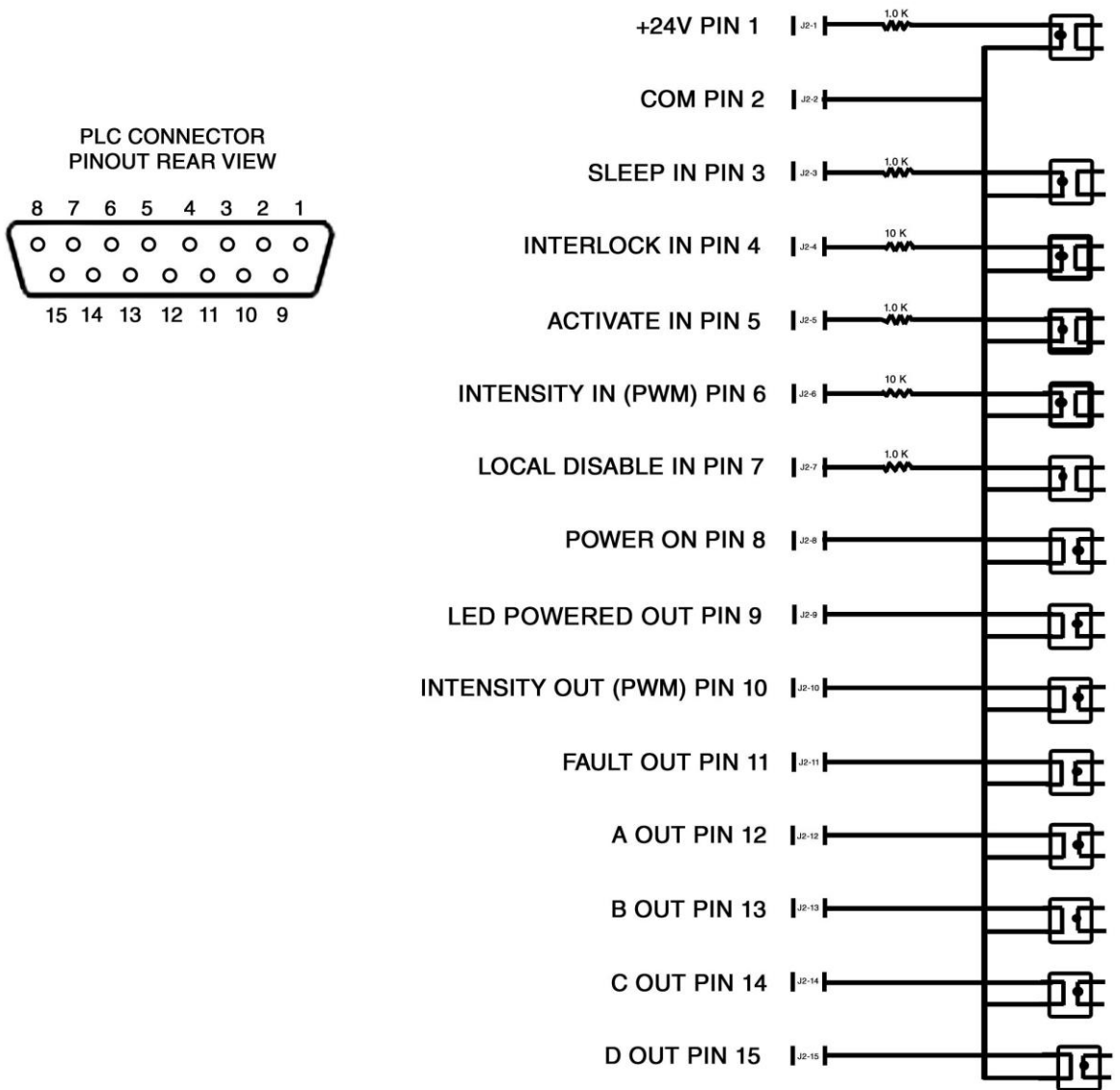

Cleaning and Maintenance

System Cleaning

Optic Lens

Based on the cleanliness of your operating environment, establish a schedule for cleaning the LED Light-Source Lens. When cleaning is required, shut the unit down and allow it to cool. Then clean the Lens surface (Figure 14) with a clean lint-free cloth and isopropyl alcohol.

Figure 14. Lens Assembly

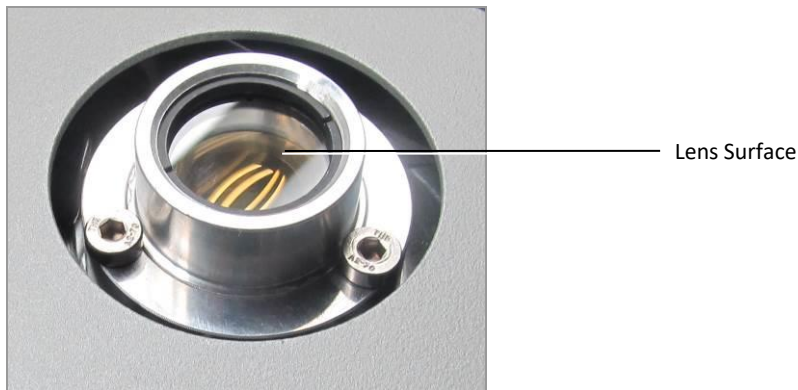

Replace Cooling Fan Filters

One Cooling Fan Filter is located on the Irradiator Head and one is located on the Controller. The procedure for cleaning or replacing the Cooling Fan Filter is similar on both components. One procedure is provided below.

Based on the cleanliness of your operating environment, establish a schedule for cleaning the Cooling Fan Filter. When the Cooling Fan Filter shows signs of wear from cleaning and use, replace it with one of the spare Filters provided with your unit. Follow these steps to wash or replace the Cooling Fan Filter:

1. Unplug the unit.
2. Remove the Filter Cover by lifting it from the Irradiator Head (Figure 15).
3. Remove the Foam Filter from the Filter Cover.
4. If the Foam Filter is serviceable, wash it with water and a mild detergent. Allow it to dry.
If the Foam Filter is not serviceable, replace the Foam Filter with a new one supplied with your unit.
5. Install a Foam Filter in the Filter Cover.
6. Install the Filter Cover on the Fan.
7. Clear the error code on the Display Screen. To clear the code, press and hold the Run Button while turning on the power to the system.

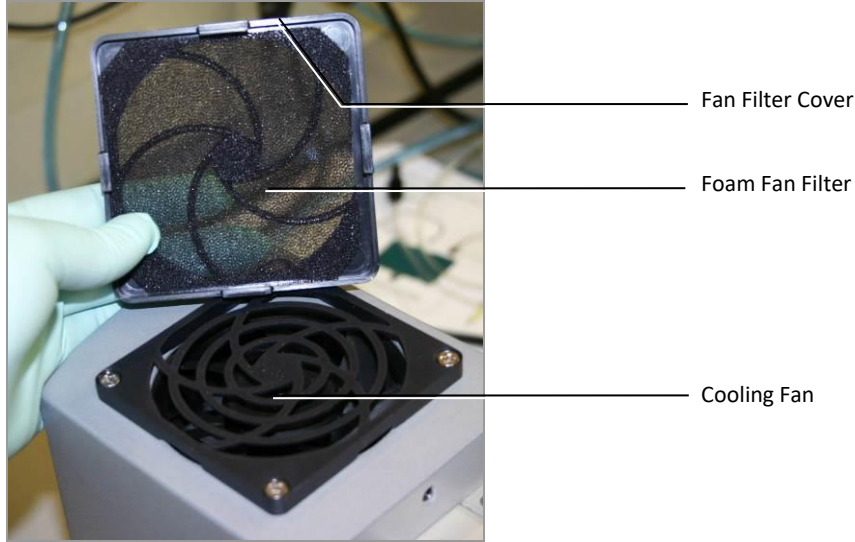
Figure 15. Cooling Fan Filter Replacement

Inspect and Replace Fuses

The Controller uses two Fuses held in a Fuse Holder. Follow these steps to inspect and replace the Fuses if indicated as a corrective action based on troubleshooting:

1. Unplug the unit.
2. Remove the Fuse Tray Cover using a small screwdriver (Figure 16).
3. Slide out the Fuse Tray using a small screwdriver.
4. Remove and inspect the Fuses.
5. Replace blown Fuses with new ones as specified in the Specifications Section.
6. Insert serviceable Fuses back into Fuse Tray.
7. Push the Fuse tray into the Power Receptacle.
8. Snap the Fuse Tray Cover back into the closed position.

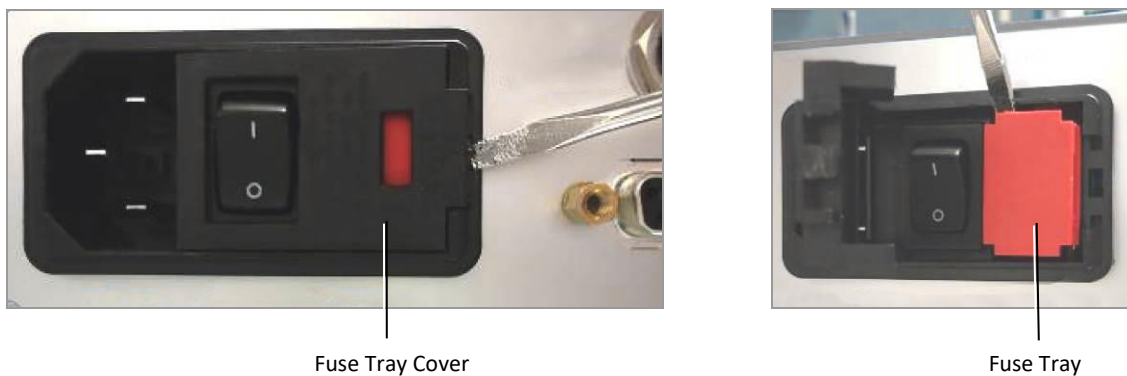
Figure 16. Opening the Fuse Tray Cover (left) and Sliding Out the Fuse Tray (right)

Error Codes and Troubleshooting

If your *BlueWave LED DX-1000 VisiCure* displays an error code (*Er01* for example), you can determine the cause of the error by referring to Table 3. If your *BlueWave* is not responding as expected, you can probably resolve the issue using the troubleshooting chart (Table 4).

Table 3. Error Codes

Error Code	Description
Er01	Power supply failure [terminate current cure cycle and shut down]
Er02	Fan failure in Irradiator Head [Complete current cure cycle then shut down]
Er03	LED Over Temp [terminate current cure cycle and shut down]
Er04	Temp sensor open (failed or unplugged) [terminate current cure cycle and shut down]
Er05	Control box over temp [terminate current cure cycle and shut down]
Er06	LED over current [terminate current cure cycle and shut down]
Er07	If Er06 occurs and current cannot be shut down alert beeper continuous to indicate unit needs to be powered down.
Er08	5V failure to LED. Check connections and LED module.
Fltr	Change Filter [complete current cure cycle then shut down]

Table 4. Troubleshooting Chart for *BlueWave LED DX-1000 VisiCure*

Problem	Possible Cause	Corrective Action
<i>BlueWave LED DX-1000 VisiCure</i> does not power up	Power Cord not plugged in or damaged	Check Power Connection and condition.
	Onboard Fuse blown	Check Onboard Fuse.
	No electrical power at Receptacle	Test Receptacle for power.
<i>BlueWave LED DX-1000 VisiCure</i> powers up but LED does not produce light	LED intensity adjustment set to minimum	Increase LED intensity setting.
	Lens Cover is still in place	Remove Lens Cover. Clean Output Window if necessary.
	Interface Cable connections loose or damaged	Check connections and condition of Interface Cable.
<i>BlueWave LED DX-1000 VisiCure</i> is operating normally and LED suddenly stops producing light	Over-temperature shutdown was triggered	Check that the flow of cooling air into the Controller or Irradiator Head unit is not restricted. Check that the Filter is clean. If the LED does not illuminate after restarting, contact Dymax Applications Engineering.
LED light source provides only low-intensity light	LED intensity adjustment set to minimum	Increase LED intensity setting.
	Contaminated/dirty Lens optics	Clean the surface of the Lens.
Footswitch does not function	Footswitch not connected	Connect Footswitch.
	Footswitch defective	Activate unit using the Front Control Panel. Replace the Footswitch if the unit operates from the Front Control Panel.
Unit appears to run hot	Cooling Fan Filter is dirty or blocked	Replace Cooling Fan Filters. Remove items that are blocking Filter and Air Inlet.
	Insufficient clearance around the Controller	Ensure 1" [2.54 cm] inch of clearance is provided around the Controller and at least 6" [15.24 cm] inches of clearance are provided around the Cooling Fan Inlets.
	Fan not operating	Ensure Fan is operating. Contact Dymax Applications Engineering.
	Controller is contaminated with dust or debris	Contact Dymax Applications Engineering.

Spare Parts and Accessories

Options/Accessories

Item	Part Number
Personal Protection Equipment	
Protective Goggles — Green	35286
Protective Goggles — Gray (standard model included with unit)	35285
Face Shield	35186
Flexible Amber Shielding with Magnetic Attachment Strip	40719
Radiometer	
Dymax ACCU-CAL™ 50-LED Radiometer (spot)	40505
Dymax ACCU-CAL™ 50-LED Radiometer (flood)	40519
Stands	
Benchtop Stand and Work Platform (Benchtop mini-flood mode)	40725
Benchtop Base and Lightguide Adapter	40755
Lenses & Adapters	
2-Lens Optic #1	40581
Lightguide Adapter	40743
Lightguides	
Liquid-D Lightguide, 5 mm x 1 M	5720
Liquid-D Lightguide, 5 mm x 1.5 M	5721
Liquid-D Two-Pole Lightguide, 3 mm x 1 M	38476
LED Interconnect Cable Assembly	
Controller to Irradiator Head Power Cable, 19" [48.26 cm]	40744
Controller to Irradiator Head Power Cable, 36" [91.44 cm]	40583
Controller to Irradiator Head Power Cable, 72" [182.88 cm]	40745
Controller to Irradiator Head Power Cable, 120" [304.80 cm]	40746



Benchtop Stand and Work Platform



Lightguide Adapter



ACCU-CAL™ 50-LED



2-Lens Optic #1

Spare/Replacement Parts

Item	Part Number
Key System Components	
DX-1000 Controller	40599
DX-1000 Irradiator	40588
Fuses	
Fuses: F2.0 amp	37236
Fan Filters	
Fan Filter and Holder (Irradiator Head)	5097
Fan Filter Media (Irradiator Head)	40008
Fan Filter and Holder (Controller)	40605
Fan Filter Media (Controller)	40705
Footswitch and AC Power Cords	
Footswitch	40402
Power Cord, North American	35255
Power Cord, no molded plug end	37008
Power Cord, China	40542
User Manuals	
User Manual, English	41061
Tools & Hardware	
2 mm Hex Wrench	38656
3 mm Hex Wrench	40720
4 mm Hex Wrench	40721
M5 x 8 mm Low-Profile Socket Hex Screws	40578
M6 x 12 mm Hex Screws	40740
M5 x 12 mm Philips Pan Head Screws	39682
M5 x 10 mm Hex Screws	40741
Miscellaneous	
Silicone Pad (for Benchtop Stand Base)	40747



Benchtop Base



Controller to Irradiator Head Power Cable



Footswitch

Specifications

Packages

Package	No Power Cord*	North American Version (120V power cord)	Asian Version (Type G power cord)
Basic System Includes irradiator head with collimating optic #1, controller, footswitch, and magnetic shielding. Choice of interface cable and power cord.	41046	-	-
Flood Mode Package Includes controller, irradiator head, collimating optic #1, bench-top stand with silicone pad, magnetic shielding, footswitch, and interface cable.	41047	41049	41048
Spot Mode Package Includes controller, irradiator head, 5-mm lightguide, lightguide stand, lightguide adapter, footswitch, interface cable, lightguide mounting stand, and bench-top base	41051	41053	41052
Lab Developer Package Includes controller, irradiator head, 2 interface cables, lightguide adapter, collimating optic #1, bench-top stand with silicone pad, bench-top base, 5-mm lightguide, footswitch, and magnetic shielding	41055	41057	41056

*For European customers, the appropriate power cord is added.



Specifications

Property	Specification
Intensity Output	Minimum 1.2 [W/cm ²] at 1" [2.54 cm] as measured with an ACCU-CAL™ 50-LED in flood mode. See Figure 18 for further intensity information.
Output Frequency	405 nm (see Figure 16 below)
Power Requirements	100-240 V, 47-63 Hz (auto ranging)
LED Timer	0.1 to 999.9 seconds
LED Activation	Footswitch, Front Panel, or PLC
Cooling	Forced air, filtered fan
Hour Meter	Unit operation and exposure (non-resettable)
Controller Dimensions	6.5" x 9.0" x 2.25" [16.51 cm x 22.86 cm x 5.72 cm] (W x D x H)
Irradiator Head Dimensions	4.0" x 5.0" x 4.5" [10.16 cm x 12.70 cm x 11.43 cm] (W x D x H)
Interface Cable Length (standard)	19" [48.26 cm] (custom lengths available)
I/O Port	15-Pin D-Sub
Weight	Controller: 1.5 lbs [0.68 kg] Head: 3.0 lbs [1.36 kg]
Unit Warranty	1 year from purchase date
Operating Environment	5 – 40°C, non-condensing
Sound Level	<65 decibels @ 12" [30.48 cm] distance (at full power)
Recommended Accessories	40505 (ACCU-CAL™ 50-LED Radiometer)

Figure 17. BlueWave® LED DX-1000 Intensity by Distance and Delivery Mode

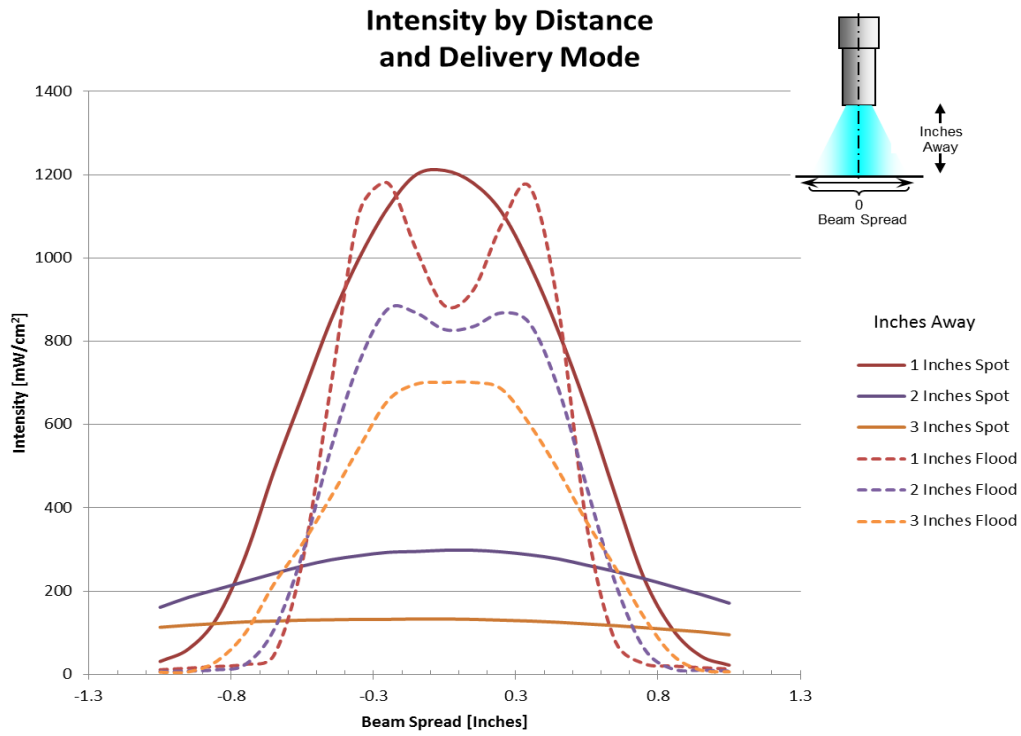

Figure 18. BlueWave LED DX-1000 Spectral Output



Warranty

From date of purchase, Dymax Corporation offers a one-year warranty against defects in material and workmanship on all system components with proof of purchase and purchase date. Unauthorized repair, modification, or improper use of equipment may void your warranty benefits. The use of aftermarket replacement parts not supplied or approved by Dymax Corporation, will void any effective warranties and may result in damage to the equipment.

IMPORTANT NOTE: DYMAX CORPORATION RESERVES THE RIGHT TO INVALIDATE ANY WARRANTIES, EXPRESSED OR IMPLIED, DUE TO ANY REPAIRS PERFORMED OR ATTEMPTED ON DYMAX EQUIPMENT WITHOUT WRITTEN AUTHORIZATION FROM DYMAX. THOSE CORRECTIVE ACTIONS LISTED ABOVE ARE LIMITED TO THIS AUTHORIZATION.

Index

- Assembly and Setup, 12
- Back Panel Controls, 11
- Cable Connections, 14
- Cleaning and Maintenance, 19
- Cleaning the Lens, 19
- Curing System Safety, 5
- Error Codes and Troubleshooting, 21
- Fan Filters, 19
- Features and Benefits, 8
- Filter Cleaning, 19
- Filter Replacement, 19
- Front Panel Controls, 10
- Fuse Replacement, 20
- Fuses, 20
- Help, 4
- Intensity Control Feature, 8
- Lens Cleaning, 19
- Maintenance, 19
- Operation, 15
- Optional Equipment, 23
- PLC Interface, 17
- Powering up the Controller, 15
- Product Overview, 7
- Safety of UV Light
 - Bright Visible Light, 7
 - High-Temperature Surfaces, 6
 - UV Exposure, 5
- Spare Parts and Accessories, 23
- Specifications, 25
- Stand, 16
- Support, 4
- System Connections, 14
- Technical Description of BlueWave System, 7
- Troubleshooting, 22
- Using Advanced and Optional Features, 16
- Using the Optional Stand, 16
- Using the System, 15
- UV Exposure, 5
- UV Light Shielding, 6
- Validation, 9
- Warranty, 27



© 2013-2016 Dymax Corporation. All rights reserved. All trademarks in this guide, except where noted, are the property of, or used under license by Dymax Corporation, U.S.A.

Please note that most dispensing and curing system applications are unique. Dymax does not warrant the fitness of the product for the intended application. Any warranty applicable to the product, its application and use is strictly limited to that contained in Dymax's standard Conditions of Sale. Dymax recommends that any intended application be evaluated and tested by the user to insure that desired performance criteria are satisfied. Dymax is willing to assist users in their performance testing and evaluation by offering equipment trial rental and leasing programs to assist in such testing and evaluations. Data sheets are available for valve controllers or pressure pots upon request.

PN41061 MAN057 11/30/2016

Dymax Corporation

+1.860.482.1010 | info@dymax.com | www.dymax.com

Dymax Europe GmbH

+49 611.962.7900 | info_de@dymax.com | www.dymax.de

Dymax Engineering Adhesives Ireland Ltd.

+353 21.237.3016 | info_ie@dymax.com | www.dymax.ie

Dymax Oligomers & Coatings

+1.860.626.7006 | info_oc@dymax.com | www.dymax-oc.com

Dymax Korea LLC

+82.31.608.3434 | info_kr@dymax.com | www.dymax.com/kr

Dymax UV Adhesives & Equipment (China) Co. Ltd.

+86.755.83485759 | dymaxasia@dymax.com | www.dymax.com.cn

Dymax Asia (H.K.) Limited

+852.2460.7038 | dymaxasia@dymax.com | www.dymax.com.cn

Dymax Asia Pacific Pte. Ltd.

+65.6752.2887 | info_ap@dymax.com | www.dymax-ap.com