

Discontinued 1/1/2021



BlueWave[®] MX-Series 1-Channel Controller

User Guide



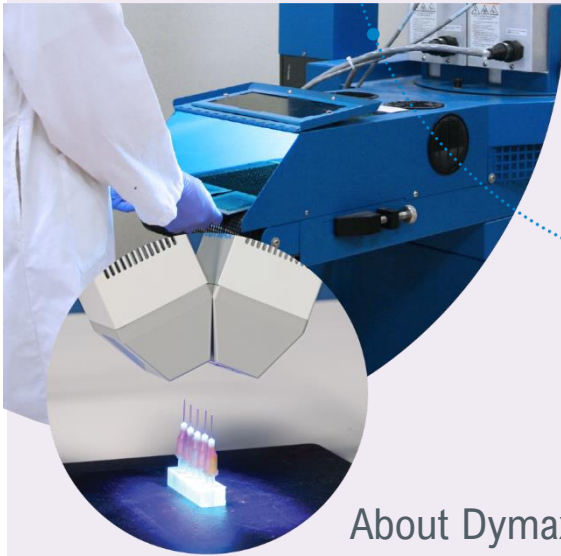

About Dymax

Light-curable adhesives. Systems for light curing, fluid dispensing, and fluid packaging.

Dymax manufactures industrial adhesives, light-curable adhesives, epoxy resins, cyanoacrylates, and activator-cured adhesives. We also manufacture a complete line of manual fluid dispensing systems, automatic dispensing systems, and light-curing systems. Light-curing systems include LED light sources, spot, flood, and conveyor systems designed for compatibility and high performance with Dymax adhesives. Dymax adhesives and light-curing systems optimize the speed of automated assembly, allow for 100% in-line inspection, and increase throughput. System designs enable stand-alone configuration or integration into your existing assembly line.

Please note that most dispensing and curing system applications are unique. Dymax does not warrant the fitness of the product for the intended application. Any warranty applicable to the product, its application, and use is strictly limited to that contained in the Dymax standard Conditions of Sale. Dymax recommends that any intended application be evaluated and tested by the user to ensure that desired performance criteria are satisfied. Dymax is willing to assist users in their performance testing and evaluation. Data sheets are available for valve controllers or pressure pots upon request.

Contents

Introduction	4
Where to Get Help.....	5
Safety	5
Product Overview	6
Description of BlueWave MX-Series 1CH Controller....	6
Controller Front Panel.....	7
Controller Back Panel	8
Unpacking	9
Parts Included	9
System Setup	9
System Connections	9
Modes of Operation	11
Manual Mode	11
Timer Mode	11
PLC (Programmable Logic Controller) Operation.....	12
Examples of PLC Wiring	15
Operation	17
Control Screen.....	18
Irradiation.....	20
Saving Programs	21
System Settings	21
Language Settings	22
Volume Settings.....	23
Brightness Settings	24
User Settings/Boot Modes	24

System Information	25
Troubleshooting & Maintenance	26
Measuring/Checking Intensity	26
Product Cleaning.....	26
Alarms.....	26
Accessories	28
Spare Parts	29
Specifications	30
Validation	31
Set Exposure Time, Determine Intensity	31
Set Intensity, Determine Exposure Time	31
Control	31
Declaration of Conformity	32
Warranty	33

Introduction

This guide describes how to set up, use, and maintain BlueWave® MX-Series Systems using a 1-Channel (CH) Controller safely and efficiently.

Intended Audience

This user guide is meant for experienced process engineers, technicians, and manufacturing personnel. If you are new to high-intensity LED light sources and do not understand the instructions, contact Dymax Application Engineering for answers to your questions before using the equipment.

Where to Get Help

Dymax Customer Support and Application Engineering teams are available by phone in the United States, Monday through Friday, from 8:00 a.m. to 5:30 p.m. Eastern Standard Time. You can also email Dymax at info@dymax.com. Contact information for additional Dymax locations can be found on the back cover of this user guide.

Additional resources are available to ensure a trouble-free experience with our products:

- Detailed product information on dymax.com
- Dymax adhesive product data sheets on our website
- Safety data sheets (SDS) provided with shipments of Dymax materials

Safety



WARNING! *If you use this UV LED light control without first reading and understanding the information in the Safety Guide SAF001, injury can result from exposure to high-intensity light. To reduce the risk of injury, please read and ensure you understand the information in that guide before assembling and operating the Dymax UV LED light system.*

Product Overview

Description of BlueWave MX-Series 1CH Controller

BlueWave MX-Series Controller when combined with MX Series emitters feature all the benefits of LED-curing technology in smaller, more versatile units. These systems are uniquely designed to offer higher, more consistent curing intensity than traditional spot or flood curing systems. The systems are comprised of a power supply, a controller with an easy-to-use control interface, and a high intensity emitter.

The system can be truly tailored to users' curing needs – allowing them to choose from any of the different emitter types and different wavelength LED emitters (365, 385, or 405 nm) in three cure pattern formats; spot, mini-flood and line emission patterns. This flexibility ensures optimal cures are achieved across a variety of bond-line geometries. Users also have endless set up flexibility; for automated curing processes, the emitter can be easily mounted machine arms or further from the controller without fear of intensity variations. When used as a bench-top curing system, the unit can be paired with a stand and shielding or a lightguide can be connected to the system for specialized applications when paired with MX spot emitters.

- The BlueWave® MX-150 functions as a high-intensity spot-curing system. The system has the ability to be set up in many configurations and can be used with a lightguide if needed.
- The BlueWave® MX-250 functions as a flood-curing system with a 50 mm x 50 mm (2 in x 2 in) active curing area. It provides manufacturers with additional curing flexibility and expansion capabilities BlueWave MX-Series emitters can be used as hand-held units or integrated into an automated manufacturing system allowing for maximum application flexibility. Their output intensity levels can also be adjusted from 1% to 100% to meet process and adhesive requirements. BlueWave MX-Series 1CH systems are rated for continuous operation. However, if the internal temperature of the system exceeds the maximum safe operating temperature limits, each emitter contains a thermal sensor that will shut the unit down to protect the components of the emitter.
- The BlueWave® MX-275 functions as a line pattern flood-curing system with a 5 mm x 50 mm (0.2 in x 2 in) asserted curing area.

Controller Front Panel

The front panel features the power button and a touchscreen display through which the unit can be operated.

Power Button — Press the power button to power up the controller. Press the button a second time to turn the unit off.

Figure 1.
Front Control Panel



Controller Back Panel

Power Cord Receptacle — Connection point for the power cord.

Foot Pedal Jack — Connection point for the foot pedal.

PLC Connector Terminals — Connection points for an interface with a user-supplied PLC (for remote operation).

Emitter Connector — Connection point for the system's emitter.

Figure 2.
Back Panel Controls & Connections

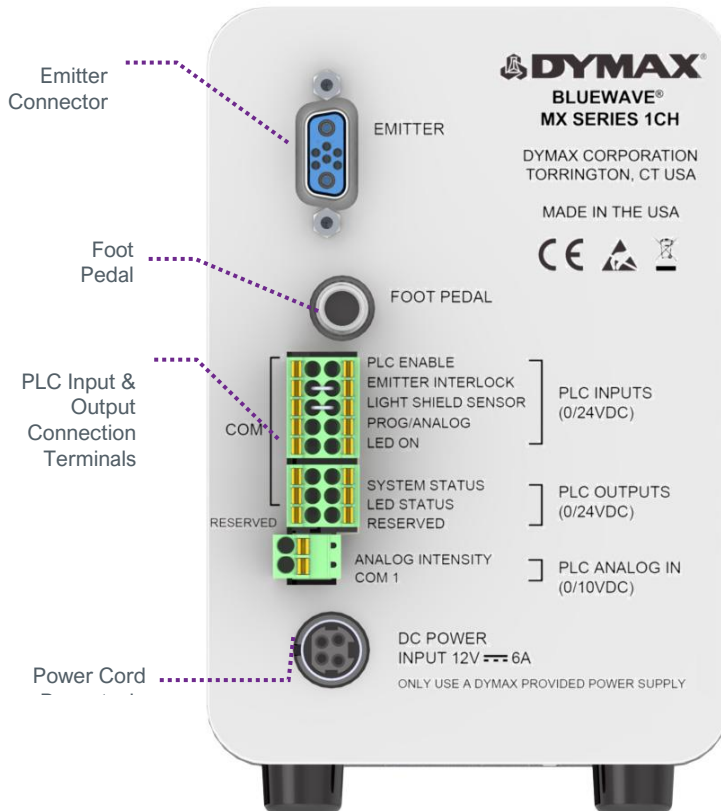

Unpacking

Upon arrival, inspect all boxes for damage and notify the shipper of box damage immediately. Open each box and check for equipment damage. If parts are damaged, notify the shipper and submit a claim for the damaged parts. Contact Dymax so that new parts can be shipped to you immediately.

The parts below are included in every package/order. If parts are missing from your order, contact your local Dymax representative or Dymax Customer Support to resolve the problem.

Parts Included

- Controller
- Power Supply
- Emitter Cable
- Power Cord
- Foot Pedal
- Safety Glasses
- BlueWave MX-Series 1CH User Guide

System Setup

System Connections

NOTE: Although this product is designed with protection against ESD (Electrostatic Discharge) it is recommended to take precautions against static when handling the BlueWave MX-Series controller or LED emitter independently. Once these devices are attached together through the interconnect cable, then the threat of ESD damage is eliminated.

1. Attach the Power Cord to the Power Cord Receptacle located on the unit's back panel (Figure 2).
2. At the top of the Controller's Rear Panel, there is a connector labeled "Emitter" (Figure 4). Connect one end of the Emitter Cable to this connector and the other end to the Emitter.

WARNING! Under no circumstance should the interconnect cable from the BlueWave MX-Series 1CH controller to the LED emitter be connected or disconnected while power to the unit is on. This procedure is usually called “hot-swapping” and should not be performed as it could cause damage to the controller or the LED emitter. Always power down the equipment before disconnecting any of these devices.

3. Plug the opposite end of the Power Cord into an appropriate AC outlet. The unit is now powered and ready to be turned on with the On/Off Switch located on the front of the unit (Figure 3).

WARNING! If the BlueWave MX-Series 1CH controller is powered on with no LED emitter connected, the controller screen will not show the banner containing the information of the emitter type or wavelength. An error will appear on the display and an audible alarm will sound. Power down the controller, connect the LED emitter, then power on again and the banner will appear.

4. If using the optional foot pedal, plug it into the foot pedal jack on the rear panel of the controller.

If you are using a PLC - There are input and output PLC Connection Terminals that can be used to integrate the unit to an automated assembly line. The input connections consist of PLC Enable, Emitter Interlock, Light Shield Sensor, Program/Analog, and LED On. The unit normally has high logic levels (24V) and looks for a low signal (0V) input. The 24VDC is supplied internally allowing use of a simple contact closure such as a switch or relay to actuate the inputs.

The output PLC connection terminals consist of System Status, LED status and Reserved. These output signals are 24VDC inactive and 0 Volts active.

The Analog intensity input is a 0 – 10 Volt input that controls the LED intensity. This function is active when the Prog/Analog and PLC Enable inputs are activated.

Refer to Table 1 for more complete description of PLC input and outputs.

5. Your unit is now ready for operation.

Modes of Operation

The system has three basic modes of operation: manual, timer, and PLC.

Manual Mode

In manual mode, the LED is energized when the foot pedal is pressed, passing curing energy through the delivery optics, and de-energized when the foot pedal is released. The LED may also be energized by momentarily pressing the run/stop button located in the center of the touchscreen user interface. The LED will be energized to the power level set through the touchscreen user interface. Pressing the run/stop button again during the curing cycle will de-energize the LED.

When manual mode is selected, the time indicator will be initialized to zero. The time display will count up during an exposure and display the total elapsed time at the end of the exposure to allow the user to save the time and power values if desired. Starting a new manual exposure will reset the time value to zero immediately and proceed to count up.

Timer Mode

In timer mode, the LED is energized for a specific time period each time the foot pedal or run button is pressed. The specific time is set by adjusting the timer's value through the touchscreen user interface. Momentarily pressing the foot pedal or run button starts the timer and energizes the LED. When the timer counts down to zero, the LED is de-energized, and no curing energy is emitted. The timer is reset to the pre-set value, and the system is immediately ready to run another exposure cycle. The LED can be de-energized at any time during the curing cycle by simply pressing the run/stop button.

PLC (Programmable Logic Controller) Operation

When in PLC mode, an external PLC can control the unit. The PLC provides input signals to the *BlueWave MX-Series 1CH* system to control the on/off signals and intensity of the LED. The PLC monitors the status of the system by reading output signals provided by the unit.

The PLC is typically programmed to start other machinery when the *BlueWave MX-Series 1CH* system becomes ready, or something starts the unit when other machinery is ready. The input and output signals are present on connector (J5) located on the back of the unit.

Figure 3.
PLC Mode Screen

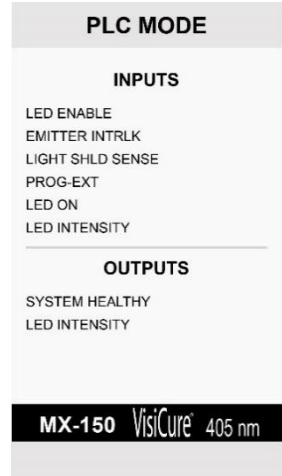

Figure 4.
PLC Inputs & Outputs

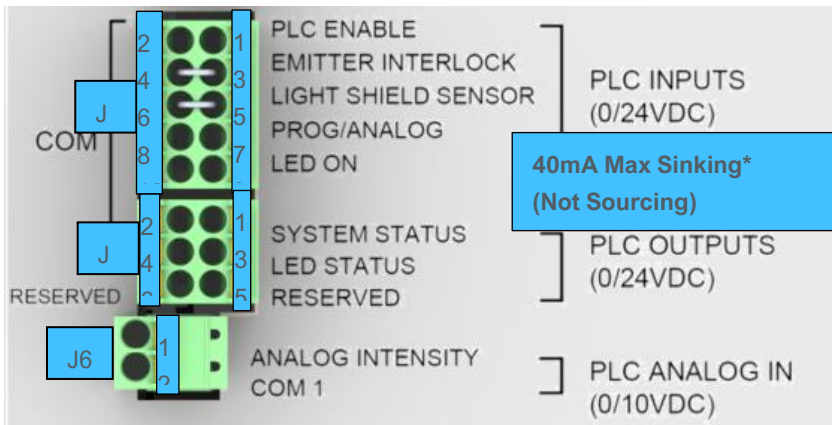

Table 1. PLC Inputs

Signal Name / Description	Isolated Inputs/ Outputs	Connector-Pin	Signal Level		
			Signal GND	Active	Inactive
PLC INPUTS					
<p>PLC ENABLE Active: Unit enters PLC mode and displays the PLC input status screen. The touch screen input is ignored.</p> <p>Inactive: All dedicated PLC inputs are ignored, and the PLC outputs will remain active.</p>	IN	1	2	0 VDC	24 VDC
<p>EMITTER INTERLOCK Asserting this signal enables the emitter. Momentarily breaking the connection via customer supplied relays or switch contacts will deactivate the emitter. Switch contacts incorporated into access doors on light shield type enclosures will stop energy emissions if the door is opened during an exposure cycle.</p>	IN	3	4	0 VDC	24 VDC
<p>LIGHT SHIELD SENSOR Active: The LED will be enabled (able to accept either LED ON IN or FOOT PEDAL IN). Inactive: The LED will be disabled.</p>	IN	5	6	0 VDC	24 VDC
<p>PROG/ANALOG Active: The internal programmed time/power settings will be used. Inactive: The external analog intensity input (PLC ANALOG IN) will be active and require a voltage at the ANALOG INTENSITY input pins.</p>	IN	7	8	0 VDC	24 VDC
<p>LED ON Manual operation: The LED turns on while the signal is active. Automatic operation: The LED turns on for the programmed time duration upon signal activation. The timed cycle must complete before another signal activation is recognized.</p>	IN	9	10	0 VDC	24 VDC

NOTE: When you initiate PLC mode you have the option to toggle PROG/ANALOG(EXT). PROG will use the program that has been selected via the

MANUAL input interface GUI. Ensure you are in Manual Mode prior to switching to PLC mode.

ANALOG(EXT) mode you can control the intensity via the analog intensity input J6 (1VDC = 10% intensity, 7VDC = 70%, etc) and have your PLC output manage the exposure time by asserting the LED ON command. For the best performance, especially when using very short exposure times, EXTERNAL PLC control is suggested to minimize latency found when using either MANUAL or TIMER mode.

Table 2. PLC Outputs & PLC Analog In

Signal Name / Description	Isolated Inputs/ outputs	Connector-Pin	Signal Level		
			Signal GND	Active	Inactive
PLC OUTPUTS					
SYSTEM STATUS Active: Indicates the system is healthy. Inactive: Indicates that the system has one or more operational problems.	OUT	1	2	0 VDC	24 VDC
LED STATUS Indicates LED is commanded on. The LED "On" status will stay in OFF state when in error condition.	OUT	3	4	0 VDC	24 VDC
RESERVED No Connection		5	6		
PLC ANALOG IN					
ANALOG INTENSITY Analog signal applied to this input to control the LED intensity. (1.0V = 10% intensity) **	IN	1	2	0 to 10 VDC	

**A ferrite will be required on the PLC (0-10V) analog input cable to reduce noise. Ferrite bead (PN 0443164251) installed on the analog PLC cable (looped once) at the termination end.

Examples of PLC Wiring

Figure 5.
PLC Interface Using Dry Contact Switches or Relays

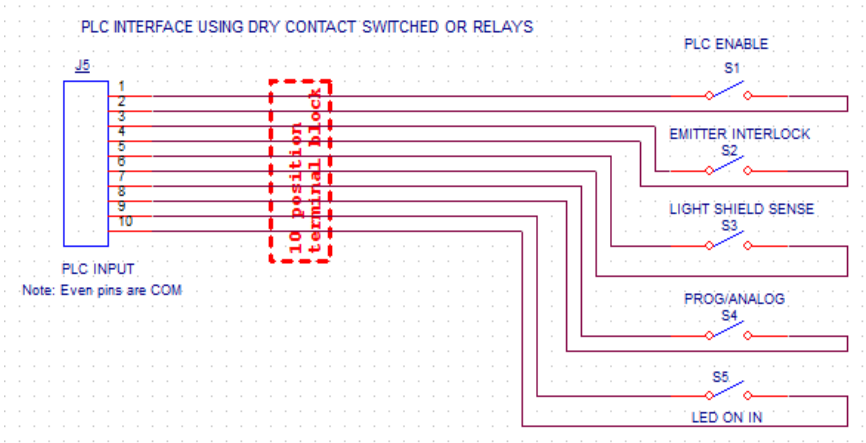

Figure 6.
PLC Analog Control Input

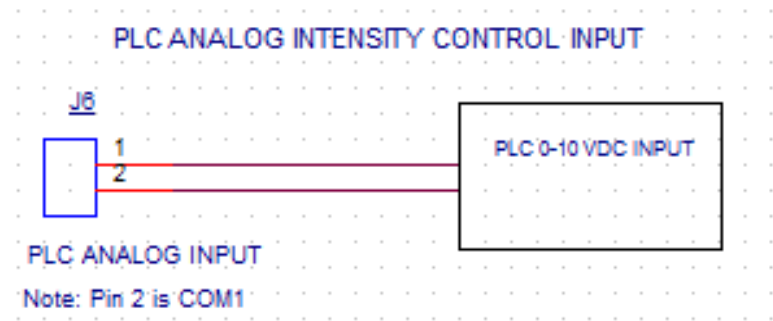

Figure 7.
PLC Discrete Status Outputs

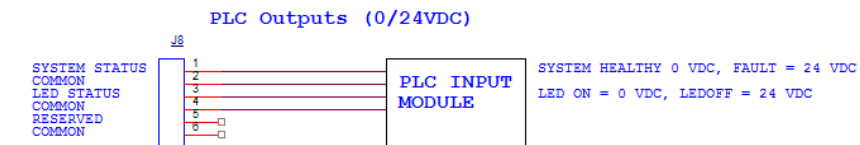
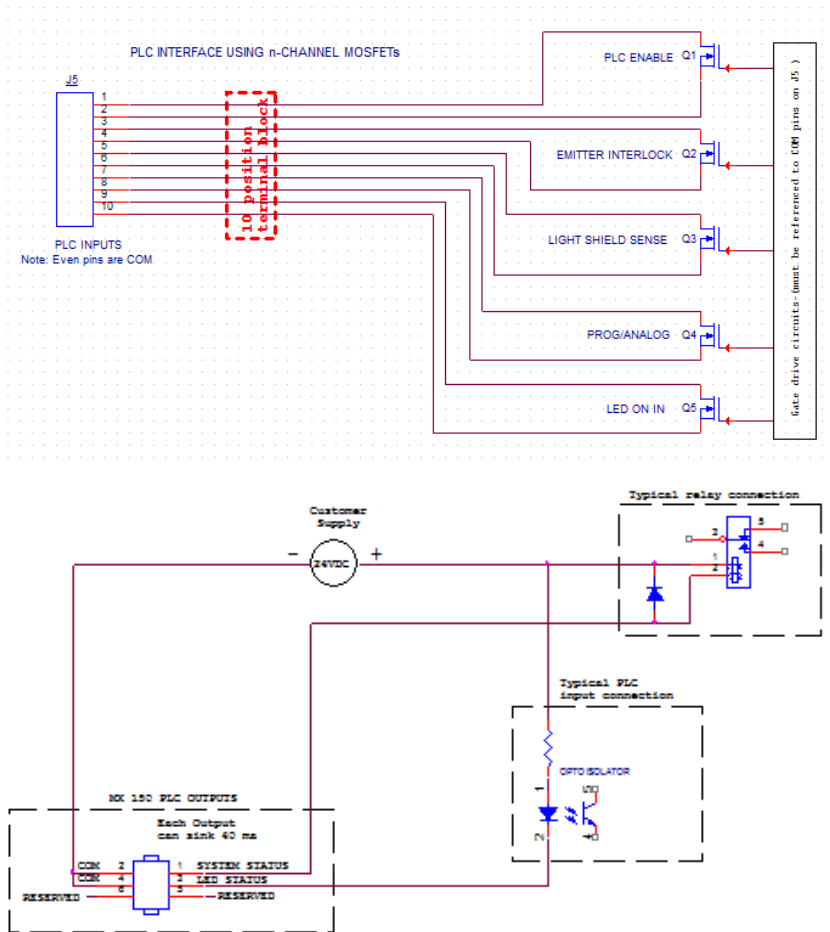

Figure 8.
 PLC Interface Using n-Channel Mosfets or Relays



Note: The PLC status outputs have a maximum sink current of 5 mA each. It is recommended to use a solid-state relay with a control current <5 mA.

Recommended Relays: Weidmuller 8820710000, Phoenix Contact 2980636

Operation

To operate the system, first verify that all Connectors are correctly plugged into the rear panel of the unit (See *System Connections*, pg. 9 for more details). When all Connectors are properly plugged in, press the Power Button on the front panel of the unit. The system is now ready for use.

NOTE: The following lightguide instructions apply to the MX-150 emitter operation only. The MX-250 emitter emits a flood pattern, so lightguide references are not applicable to this unit.

The insertion of the 5-mm lightguide adapter, or an actual lightguide, into the end of the LED emitter needs to be fully seated. The device utilizes 3 spring plungers inside to hold the lightguide in place. Excessive vibration may cause the lightguide to shift position and cause an error condition. End users must provide means through the use of a fixture or other device to address this situation.

Upon startup of the unit, an intro screen will appear. After 4 seconds, the control screen should appear in the display. It will be in administrator mode the first time the unit is started.

Control Screen

The control screen is used to set up and run curing cycles. This screen allows users to switch back and forth between administrator and production modes as well as between timer and manual operating modes. It is also where the cycle's time and power settings are set.

Figure 9.
Control Screen Components

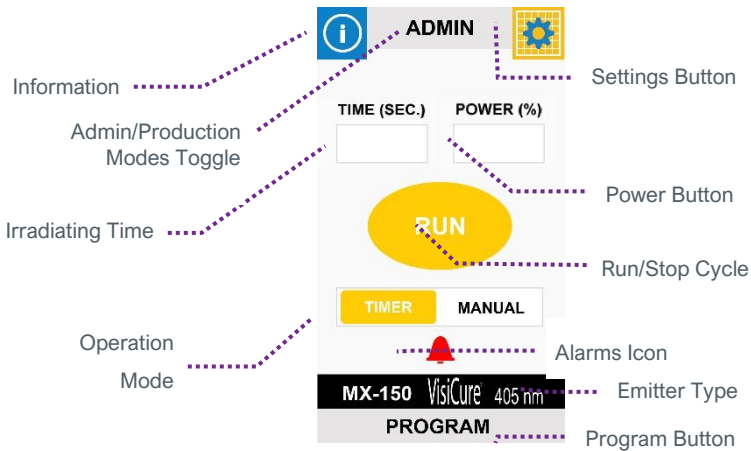

Information Button — Loads the system information screen. Refer to “System Information” on page 25 for more information.

Administration/Production Mode Toggle — Switches between administration and production modes. A password will be required to enter administrator mode. Refer to User Settings/Boot Modes for more information.

The production screen layout is identical to the administrator screen. The time, power and mode settings reflect the administrator settings and cannot be altered. User operational controls are limited to “Run/Stop”, “Volume” and “Brightness” (see Settings screen). Program(s) names will be displayed along with the Emitter type but the ability to save and load Program(s) will be disabled. The default password is 1234.

Settings Button — Loads the settings screen where the volume, language, screen brightness, and other user settings can be adjusted. Refer to “System Settings” on page 24 for more information.

Irradiating Time — The Irradiating time is displayed in this field.

When in timed mode, time is entered by touching the display field which in turn brings up a numerical keypad for entry. The entry range is 0.1 – 999 seconds. From 0.1 – 30 seconds the adjustment is made in 0.1 second increments and from 30 – 999 seconds the adjustment is made in 1 second increments.

When in manual mode, time is displayed, and entry is not available.

Power Button — The Irradiating power level is displayed in this field. The power level is entered by touching the field which in turn brings up a numerical keypad for entry. The power range is 1 to 100% in increments of 1%. Entering a decimal will result in rounding to the lowest whole number.

Run/Stop Cycle Button — Initiates/terminates an exposure. The button also functions as an indicator which informs the user that the irradiator is emitting curing energy.

Operation Mode — Select from timer or manual mode. For more information on operating modes, refer to “Modes of Operation” on page 11.

Alarms Icon — Alerts the user that there is an error. Refer to page 26 for more information.

Emitter Type — Identifies the emitter model connected to the controller and the wavelength that it provides. Emitters are available in two models, the MX-150 spot and the MX-250 flood. Each model is also available in three wavelengths: RediCure® (365 nm), PrimeCure® (385 nm), and VisiCure® (405 nm).

Program Button — Loads a list of saved curing programs to choose from.

Irradiation

To run a curing cycle in manual mode:

1. Input the power value by pressing the respective field. The time field will be disabled.
2. Press the Run Button or Foot Pedal to start the irradiation. The timer field will begin counting. The irradiation will terminate when the Stop Button is pressed or Foot Pedal is released.

The time delay for PLC or Foot pedal activation and the LED turning on is 260 ms.

When in PLC Program mode only: Add 225 ms to the LED ON in signal (J5) on the PLC connector. For example – if the user desires to turn the LED on for 1 second then the LED ON in signal (through J5) should be 1.225 sec.

To run a curing cycle in timer mode:

1. Input the time and power values by pressing on each respective field or by loading a previously saved program. To load a curing program, press the Program Button on the bottom of the screen. A list of available programs will appear. Select the appropriate one and press “LOAD”. The program will load and you will be brought back to the Control Screen.
2. Press the Run Button or Foot Pedal to start the timed irradiation. The irradiation will terminate when the count reaches zero. The timed exposure may be aborted at any time by pressing the Stop Button. Foot Pedal reactivation will not terminate the cycle.

At the conclusion of the timed exposure, the time value will be automatically reloaded in preparation for the next activation. Although the user is allowed to enter a time of 0.0 seconds, note that the LED will not activate since there is essentially no time set for it to run. The *BlueWave* MX-Series 1CH system will however support accurate LED activation as short as 0.1 seconds.

It is possible for users to type in a time setting greater than 4 digits during time entry. However, the *BlueWave* MX-Series 1CH system will only support up to 999 seconds and will default to this value if anything higher than that is entered.

Saving Programs

The current power and time settings (program) may be saved to internal memory by highlighting “New Name” and pressing “SAVE”, which will bring up a QWERTY keyboard for program name entry. The user may also save the current settings by selecting an existing program name and pressing “SAVE” to overwrite the previously saved program. Previously saved programs may be recalled by highlighting the desired program name and pressing “LOAD”. The Back button will return the user to the previous screen.

When entering program names for different time and power settings, utilize a dash or dot to separate words as the use of a space is not supported by this system.

Figure 10.
Program Screen

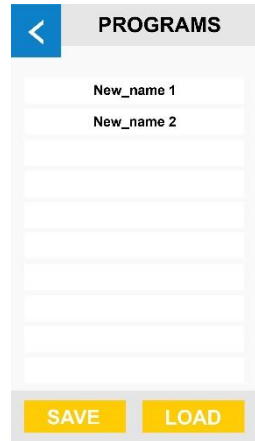

System Settings

System settings allow the user to change the language, volume, brightness, and user functions. To enter this menu press the Settings Button located in the upper right hand corner of the Production or Admin Screens.

Figure 11.
Settings Button



Figure 12.
Settings Screen

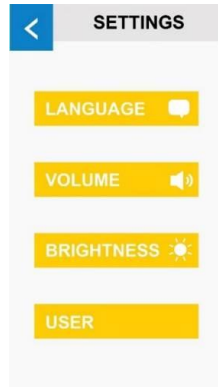

Language Settings

BlueWave MX-Series 1CH systems are currently available in English. The Back Button will return the user to the previous screen.

Figure 13.
Language Screen



Volume Settings

The volume of the Alarm Annunciator can be adjusted using the Slider Control on the Volume Screen. Moving the Slider upward towards “MAX” increases the volume, while moving the Slider downward towards “MIN” decreases it. The volume can also be muted by pressing the Mute Box. A check mark will appear in the Mute Box if the unit is muted.

When finished, press “DONE” to save the current settings and return to the previous screen. If you do not want to save the changes, press the Back Button and you will return to the previous screen without saving any changes.

Figure 14.
Volume Screen

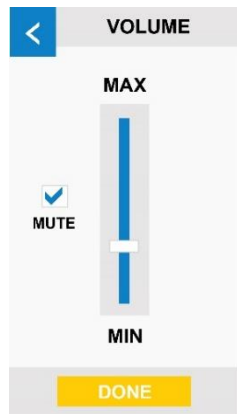

Brightness Settings

The brightness of the LCD screen can be adjusted using the Slider Control on the Brightness Screen. Moving the Slider upwards towards “MAX” increases the brightness, while moving the Slider downward towards “MIN” decreases it.

When finished, press “DONE” to save the current settings and return to the previous screen. If you do not want to save the changes, press the Back Button and you will return to the previous screen without saving any changes.

Figure 15.
Brightness Screen

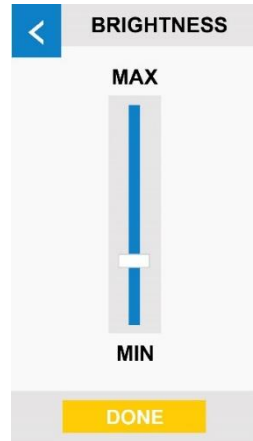

User Settings/Boot Modes

The User Button is only available while in Admin Mode and is grayed out/inactive while in Production Mode. Pressing the User Button will load the User Screen where boot mode can be selected, and the admin password may be accessed.

Figure 16.
User Screen

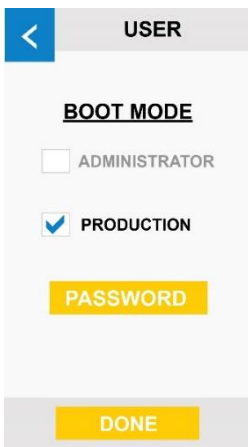
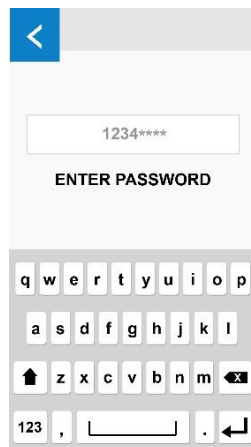

Figure 17.
Password Screen



Administrator Boot Mode

Setting the boot mode to “Administrator” will cause the Controller to enter the Admin Mode immediately following power-up. The administrator password may be accessed by pressing the Settings Button followed by the User Button. The password is entered and confirmed in the password screen via the on-screen QWERTY keyboard. The password field accepts alfa-numeric characters up to a 12-character maximum. Pressing the Return Button will save the current settings and return to the previous screen; the Back Button will return the user to the previous screen without saving any change.

When in Production Mode, to return to Administrator Mode select “PRODUCTION” and enter password.

Production Boot Mode

Setting Boot Mode to “Production” will cause the Controller to enter Production Mode immediately after power-up; no password will be required.

System Information

The System Information Screen can be accessed by pressing the Information Button in the top left corner of the Production or Admin Screens. Information such as the controller model number and the serial number, firmware revision, and run hours for the Emitter can be found here. You can also access the Alarm Screen.

Figure 18.
Information Button



Figure 19.
Information Screen



Troubleshooting & Maintenance

Measuring/Checking Intensity

ACCU-CAL™ 50-LED radiometers are designed to measure intensity levels up to 40,000 mW/cm², so they can easily handle *BlueWave* MX-Series 1CH systems. It is also capable of exposure to temperatures up to 100°C. As with any energy source, extended exposures will cause a thermal rise of the sensor assembly, so exposure times at higher intensities (>20 W/cm²) should be limited to less than 10 seconds.

Product Cleaning

Product cleaning is limited to wiping the product with a damp cloth. Do not soak. Isopropanol Alcohol or household cleaners may be used for cleaning the product.

Alarms

When the system malfunctions, a red alarm icon will appear, along with an audible beep, on the Production or Admin Screen signaling that there is a problem. To check the alarm codes, press the red Alarm Button on the bottom of the screen. Errors codes will populate the Alarm Screen. Alarms can be reset by pressing “RESET ALARMS”.

Figure 20.
Alarm Icon

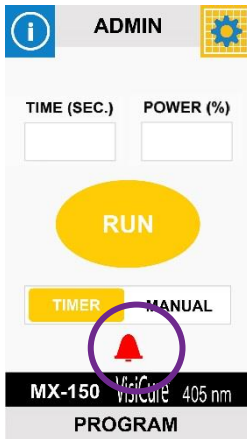
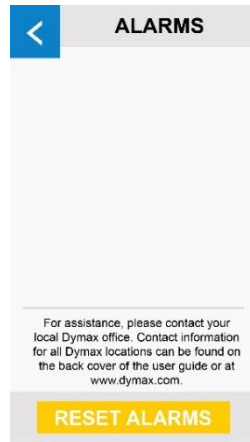

Figure 21.
Alarms Screen



Alarm Codes

Alarms are generated and displayed on the Alarm screen. The alarms include:

- Lightguide Not Installed
- Emitter Error
- Controller-Interconnect Cable
- 100, LED Over Temperature
- 103, LED Over Current
- 104, Emitter Fan Speed Low

Problem	Possible Cause	Corrective Action
BlueWave MX emitter does not produce light	LED intensity adjustment set to 0% or too low.	Increase LED intensity setting.
	LED cycle time is set to 0 seconds	0 Seconds sets Manual Mode and requires a trigger.
	Interlock is open.	Verify interlock jumpers are in place. Verify PLC command structure for PLC mode.
	Interface cable connections loose or damaged	Check connections and condition of Interface Cable.
	Trigger setting not matched to input.	Trigger setting on Admin screen should match the desired input trigger channel.
	LED head is not connected to the correct port/channel	Verify that the head is connected to the desired port/channel.
BlueWave MX system suddenly stops producing light	Over-temperature shutdown was triggered	Verify alarms.
	Footswitch defective	Activate unit using the front control panel. Replace the footswitch if the unit operates from the front control panel.
	Interlock is open.	Verify interlock jumpers are in place. Verify PLC command structure for PLC mode.
BlueWave MX emitter provides only low-intensity light	LED intensity adjustment set to minimum	Increase LED intensity setting on Admin Settings or I/O input for PLC Mode.
	Contaminated/dirty lens optics	Clean the surface of the Lens.

Accessories

Item	Part Number
Personal Protection Equipment	

Protective Goggles — Green	35286
Protective Goggles — Gray (standard model included with unit)	35285
Face Shield	35186
Radiometer	
Dymax ACCU-CAL™ 50-LED Radiometer	40505
Stands	
Emitter Mounting Stand	42390
Three-Sided Acrylic Shield	41395
Emitter Holder Assembly Bracket (MX-150 Only)	42426

Spare Parts

Item	Part Number
Power Cords	
Power Cord, North America	35255
Power Cord, Type G	40542
Key Components	
AC Power Supply	42144
Foot Pedal	40402
Interconnect Cable Assembly, 2 Meters	42287
Interconnect Cable Assembly, 5 Meters	42889

Specifications

Property	Specification
Power Supply Input	100-240V≈ 2.5A, 50-60Hz
LED Timer	0.1 to 999 seconds, max (timer accuracy 0.1%)
LED Activation	Foot pedal, LCD touchscreen, or PLC
Cooling	Air cooled
Controller Dimensions (W x D x H)	3.74" x 6.26" x 5.77" [9.5 cm x 15.9 cm x 7.9 cm]
Weight	Controller: 2.6 lbs. [1.18 kg]
Unit Warranty	1 year from purchase date
Operating Environment	10°C to 40°C (50°F to 104°F), 0-80% relative humidity, non-condensing



Figure 22.
Dimensions - Controller

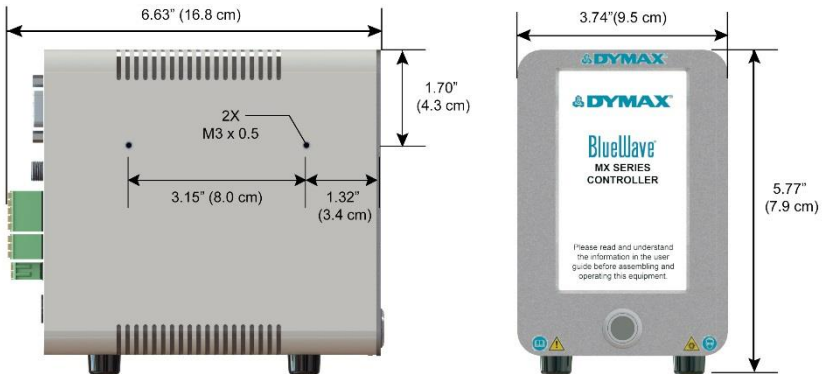

Validation

Tests should be conducted prior to production to determine the time and light intensity required to fully cure your resin. The following approaches may be used to validate the curing process.

Set Exposure Time, Determine Intensity

Users can specify a cure time and, through empirical testing, determine the intensity required to achieve a full cure. As with any manufacturing process, it is advisable to incorporate a safety factor.

Set Intensity, Determine Exposure Time

Users can specify light intensity and, through empirical testing, determine the exposure time required to achieve a full cure. As with any manufacturing process, it is advisable to incorporate a safety factor.

Contact the Dymax Application Engineering Team for additional process support.

Control

Process validation confirms a minimum acceptable intensity. Users can then choose to operate at full intensity (using the excess intensity as an additional safety factor) or adjust the output to a specific intensity level. To ensure consistent and repeatable process results, intensity levels should be monitored with a radiometer. This enables users to identify light intensity changes and take corrective action (either adjusting the light intensity or performing maintenance).

Declaration of Conformity



Declaration of Conformity

Manufacturer:
DYNAMX Corporation
318 Industrial Lane
Torrington, CT 06790, USA

European Address:
DYNAMX Europe GmbH
Kasteler Str.45
Geb.G359
Wiesbaden Germany 65203

UK Address:
Dymax
1b Hunts Grove Drive, Hardwick,
Gloucester, Gloucestershire, GL2 4BH
United Kingdom

Product description: BlueWave® MX Series 1CH Controller Curing System
Model name(s): BlueWave® MX Series 1CH Controller

This product complies with the following Directives, legal acts and standards:

European Union Compliance (CE)
Electromagnetic Compatibility Directive (2014/30/EU):
EN 55011:2009 + A1:2010
EN 61000-3-2:2014 Class A
EN 61000-3-3:2013
EN 61326-1:2013

Other Regulatory Compliance
Photo-biological Safety
IEC 62471 (2006)

Low Voltage Directive (2014/35/EU):
EN 61010-1:2010 (3rd Edition)

RoHS Directive EU (2015/863)

Declaration:

I declare that the above information in relation to the supply and manufacture of this product is in conformity with the above standards and directives.



3-10-2021

Name

Date

Authorized Signatory:
Richard MacCutcheon
Engineering Manager
DYNAMX Corporation
Torrington, CT., USA

Representative in Europe:
Dominik Stephan
Director, Equipment
DYNAMX EUROPE GmbH
Wiesbaden, Germany

Representative in UK:
Kevin Westcott
Account Manager
DYNAMX
Gloucester, United Kingdom

www.dymax.com

Americas
USA | +1 860 462 1010 | info@dymax.com

Europe
Germany | +49 611 963 7000 | info_eu@dymax.com
Ireland | +353 21 237 3016 | info_ie@dymax.com

Asia
Singapore | +65 97322367 | info_ap@dymax.com
Shanghai | +86 21 37282759 | dymacosia@dymax.com
Shenzhen | +86 755 85480769 | dymacosia@dymax.com
Hong Kong | 852 2460 7008 | dymacosia@dymax.com
Korea | +82 31 6263534 | info_k@dymax.com

©2020 Dymax Corporation. All rights reserved. All trademarks in this guide, except where noted, are the property of, or used under license by, Dymax Corporation, U.S.A.

Warranty

From date of purchase, Dymax Corporation offers a one-year warranty against defects in material and workmanship on all system components with proof of purchase and purchase date. Unauthorized repair, modification, or improper use of equipment may void your warranty benefits. The use of aftermarket replacement parts not supplied or approved by Dymax Corporation, will void any effective warranties and may result in damage to the equipment.

IMPORTANT NOTE: DYNAMX CORPORATION RESERVES THE RIGHT TO INVALIDATE ANY WARRANTIES, EXPRESSED OR IMPLIED, DUE TO ANY REPAIRS PERFORMED OR ATTEMPTED ON DYNAMX EQUIPMENT WITHOUT WRITTEN AUTHORIZATION FROM DYNAMX. THOSE CORRECTIVE ACTIONS LISTED ABOVE ARE LIMITED TO THIS AUTHORIZATION.

Index

- Accessories, 27
- Alarms, 25
- Cleaning, 25
- Components, 6
- Control Screen, 18
- Controller Back Panel, 8
- Controller Front Panel, 7
- Description, 6
- Dimensions, 28
- Help, 5
- Irradiation, 20
 - Manual Mode, 20
 - Timer Mode, 20
- Maintenance, 25
- Measuring Intensity, 25
- Modes of Operation, 11
 - Manual Mode, 11
 - PLC, 12
 - Timer Mode, 11
- Operation, 17
- Parts List, 9
- PLC Wiring Examples, 15
- Product Overview, 6
- Safety, 5
- Saving Programs, 21
- Settings, 21
 - Brightness, 23
 - Language, 22
 - Volume, 22
- Setup, 9
- Spare Parts, 27
- Specifications, 28
- Support, 5
- System Connections, 9
- System Information, 24
- Troubleshooting, 25
- Unpacking, 9
- User Settings/Boot Modes, 23

Validation, 29

Warranty, 31



www.dymax.com

Americas

USA | +1.860.482.1010 | info@dymax.com

Europe

Germany | +49 611.962.7900 | info_de@dymax.com
Ireland | +353 21.237.3016 | info_ie@dymax.com

Asia

Singapore | +65.67522887 | info_ap@dymax.com
China | +86.755.83485759 | dymaxasia@dymax.com
Hong Kong | +852.2460.7038 | dymaxasia@dymax.com
Korea | +82.31.608.3434 | info_kr@dymax.com

© 2017-2020 Dymax Corporation. All rights reserved. All trademarks in this guide, except where noted, are the property of, or used under license by Dymax Corporation, U.S.A.

Please note that most curing system applications are unique. Dymax does not warrant the fitness of the product for the intended application. Any warranty applicable to the product, its application and use is strictly limited to that contained in Dymax standard Conditions of Sale published on our website. Dymax recommends that any intended application be evaluated and tested by the user to ensure that desired performance criteria are satisfied. Dymax is willing to assist users in their performance testing and evaluation by offering equipment trial rental and leasing programs to assist in such testing and evaluations.

MAN081DA 11/3/2021