

System Discontinued 2/15/2011

BlueWave[®] 50

UV Light-Curing Spot Lamp System



BlueWave[®] 50 shown with single Lightguide

Operation Manual

TABLE OF CONTENTS

Unpacking and Inspection	Page 4
Safety	Page 5
General	Page 8
Specifications	Page 9
Installation and System Interconnect.....	Page 10
Operation	Page 12
Maintenance	Page 14
Troubleshooting	Page 15
Spare Parts List	Page 16
Definition of Terms.....	Page 17
Warranty	Page 18

The enclosed BlueWave® 50 UV-Curing Light Source was developed and manufactured by the DYMAX team, driven by a desire to best serve your needs. Before shipping, your *BlueWave* 50 was thoroughly checked and tested for trouble-free performance.

The proper set up and operation of this Spot Lamp System will maximize safety and user-friendly performance, providing optimum yield of your technological process.

THEREFORE, WE ENCOURAGE YOU TO READ, UNDERSTAND, AND FOLLOW ALL SAFETY AND OPERATING INSTRUCTIONS AND RECOMMENDATIONS COMPILED IN THIS AND OTHER RELATED MANUALS prior to setting up and operating this new Spot Lamp System, or its individual components.

Par conséquent, nous vous encouragez a lire, comprendre, et suivre toute sécurité et instructions d'opération et recommandations rédigées dans cette et autres manuels établir un lien avant de mettre en place et de faire marcher ce nouveau système de lampe de poche ou ces composants individuels.

If you encounter a problem, have any questions, or would like to help us with your suggestions or recommendations, please contact our Technical or Customer Support Departments at 860-482-1010. Trained DYMAX professionals are standing by to serve you.

Si vous rencontrez un problème, avez n'importe de questions, ou si vous voudrez de nous aider avec vos suggestions ou recommandations, s'il vous plaît contactez notre département technique ou service client à 860-482-1010. DYMAX formés professionnels attendent de vous servir.



Figure 1. BlueWave® 50 Spot-Curing Lamp

UNPACKING AND INSPECTION

Upon receipt of the unit, carefully remove the contents from the boxes and check for damage. **DYMAX is not responsible for damage from shipping – all claims for shipping damage should be made with the carrier.**

Check all boxes for contents and record any serial numbers for further reference. You may wish to retain the original shipping cartons in case you need to repackage any item for return.

If you observe or experience any problem with your equipment, notify DYMAX Customer Support, your authorized distributor, or your DYMAX Representative immediately.

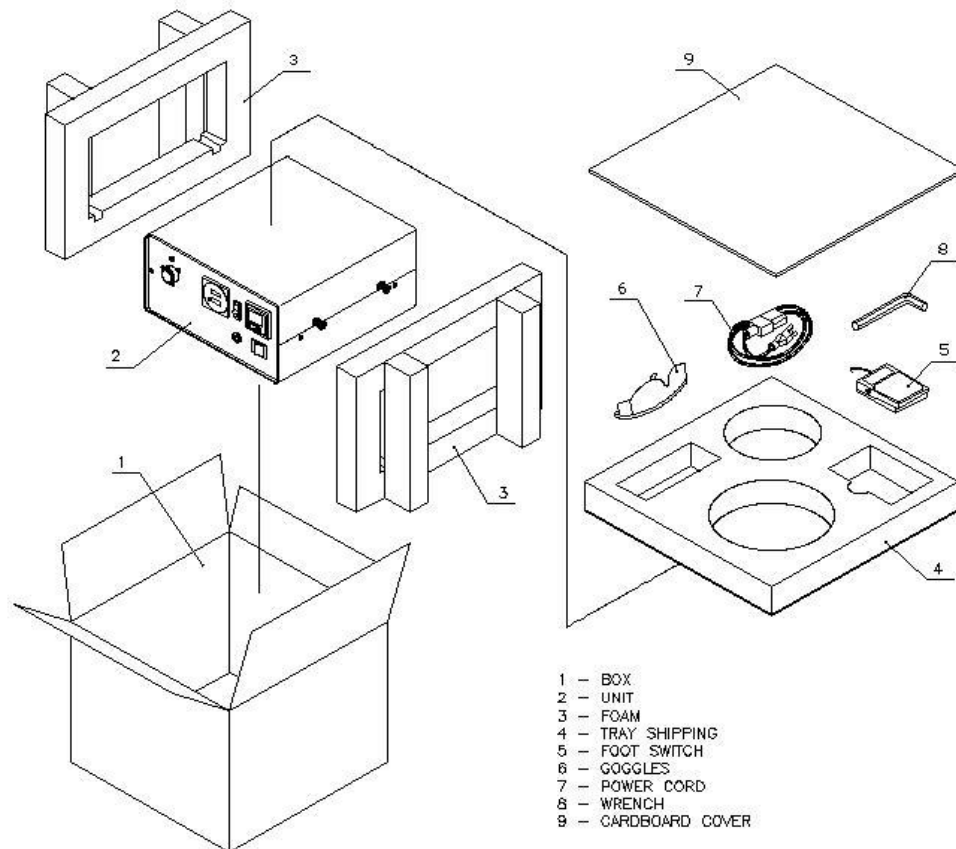

Figure 2. BlueWave® 50 Unpacking Diagram

NOTE: Lamps are shipped with the Bulb/Reflector installed.

NOTE: Report any shortage to DYMAX Customer Service.

Before continuing with unpacking and installation, please read the following Chapters of this Manual for safety recommendations and installation, running, and troubleshooting instructions.



CAUTION! Always wear protective goggles or face shield when working near the front of the unit, which emits UV light! The rear of the unit also emits stray UV light.



WARNING! Always observe safety requirements!



CAUTION! Risk of electrical shock if cover is removed!



CAUTION! Cover is warm to the touch when unit is in operation!



PRÉ-CAUTION! Toujours faire de l'usage des lunettes de protection ou protéger de visage marche près du devant d'élément!



AVERTISSEMENT! Remmarquez toujours besoin de sécurité!



PRÉ-CAUTION! Risque de décharge électrique quand le couvert est enlever!



PRÉ-CAUTION! Le couvert est chaud a le touche quand l'élément est en opération!



ACHTUNG! Tragen Sie immer eine Sicherheitsbrille oder einen Gesichtsschutz, wenn Sie nahe an der UV Lichtquelle arbeiten. Die Rückseite des Gerätes emittiert gestreutes UV Licht!



WARNHINWEIS! Bitte beachten Sie immer die Sicherheitshinweise!



ACHTUNG! Gefahr eines Stromschlages bei geöffnetem Gehäuse!



ACHTUNG! Gehäuse erwärmt sich während des Betriebs: Vorsicht bei Berührung!

SAFETY

Equipment is designed to be used properly set up, with components correctly connected, and operated in accordance with relevant instructions. The system's design was developed to maximize operator safety and minimize exposure to UV.

SAFETY RECOMMENDATIONS:

- Use the goggles provided or a face shield approved for UV protection to protect your eyes.
- Long-sleeved shirts or a lab coat are recommended to protect the arms and use of UV-opaque gloves will protect the hands.

NOTE: With the internal Filter installed, the BlueWave® 50 emits UVA and visible light. Never look directly at the light source while the unit is on.

SÉCURITÉ

L'équipement être conçu pour être utilisé correctement constituer, avec composants brancher correctement, et marché en conformément avec instructions important. Le plan états développer pour rendre au maxime opérateur sécurité et minimiser exposition à ultraviolette.

RECOMMANDER DE SÉCURITÉ:

- Emploi lunettes ou un protéger de visage pour protection de ultraviolet pour protéger vous yeux.
- Chemises à manche long ou manteau de labo sont recommander pour protéger les bras, et utilisation de ultraviolette gants opaque vais protéger les mains.

REMARQUER: avec le filtre intérieur installé, l'Onde Bleu émettre UVA et lumière visible. Ne jamais regardez directement à la source de lumière pendant que l'élément est en opération.

SICHERHEITSHINWEISE

Dieses Gerät wurde so entwickelt, dass es nur vollständig, alle Komponenten korrekt miteinander verbunden, in Übereinstimmung mit relevanten Instruktionen betrieben wird. Bei der Entwicklung wurde weiterhin großen Wert auf die Benutzersicherheit und minimale UV Belastung gelegt.

SICHERHEITSHINWEISE:

- Tragen Sie immer die mitgelieferten Sicherheitsbrille oder speziellen Gesichtsschutz, der Ihre Augen vor UV Licht schützt.
- Wir empfehlen Langarm - Hemden oder einen Laborkittel zu tragen, um die Arme zu schützen. Für die Hände empfehlen wir UV- geblockte Handschuhe.

BITTE BEACHTEN SIE: Durch den installierten inneren Filter strahlt die *BlueWave 200* UVA und sichtbares Licht aus. Schauen Sie deshalb niemals direkt in die Lichtquelle, wenn das Gerät angeschaltet ist.

DYMAX UV LIGHT-CURING SYSTEM SAFETY CONSIDERATIONS

DYMAX UV light-curing technology has been used successfully for over 30 years. The fast cure, one-component nature of our UV light-curing technology has made it the process of choice for many manufacturers requiring a cure on demand assembly process. There are four common questions/concerns related to UV light-curing systems: UV exposure, high-temperature surfaces, ozone, and bright, visible light.

UV EXPOSURE

Standard DYMAX UV light-curing systems and bulbs have been designed to primarily emit UVA light (as shown in Chart 1). UVA light is generally considered the safest of the three UV ranges: UVA, UVB, and UVC. Although OSHA does not currently regulate ultraviolet light exposure in the workplace, the American Conference of Governmental Industrial Hygienists (ACGIH) does recommend Threshold Limit Values (TLV's) for ultraviolet light. The strictest interpretation of the TLV (over the UVA range) for workers' eyes and skin is 1 mW/cm² (intensity), continuous exposure. Unless workers are placing bare hands into the curing area, it is unusual to exceed these limits. To put 1 mW/cm² limit into perspective, cloudless summer days in Connecticut regularly exceed 3 mW/cm² of UVA light and also include the more dangerous UVB light (primarily responsible for sun tans, sun burns, and skin cancer) as well.

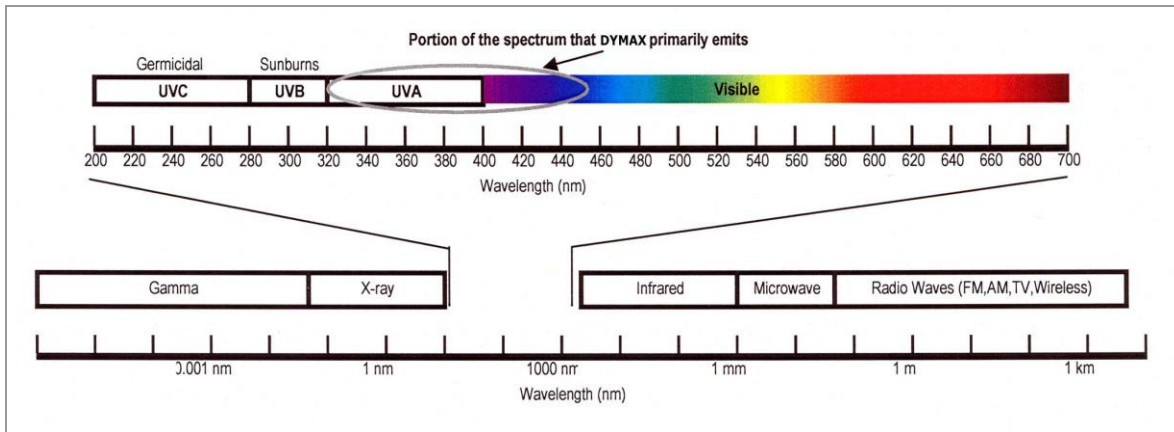

Chart 1. Light Spectrum

The human eye can not detect “pure” UV light, only visible light. A radiometer should be used to measure stray UV light to confirm the safety of a UV light-curing process. A workstation that exposes an operator to more than 1 mW/cm² of UVA continuously should be redesigned.

UV light-curing of adhesives can be a regulatory compliant, “worker-friendly” manufacturing process when the proper safety equipment and operator training is utilized. There are two ways to protect operators from UV exposure: shield the operator and/or shield the source.

SHIELD THE OPERATOR

- **UV-Blocking Eye Protection** – UV-blocking eye protection is recommended when operating UV light-curing systems. Both clear and tinted UV-blocking eye protection is available from DYMAX.
- **UV-Blocking Skin Protection** – Where the potential exists for UV exposure upon skin, opaque, UV-blocking clothing, gloves, and full-face shields are recommended.

SHIELD THE SOURCE OF UV

Any substrate that blocks UV light can be used as a shield to protect workers from stray UV light. The following materials can be used to create simple shielding structures or blind corners:

- **Sheet Metal** – Aluminum, steel, stainless steel, etc. Sheet metal should be coated black or black anodized to minimize reflection of UV and visible light toward operators.
- **Rigid Plastic Film** – Transparent, UV-blocking plastics (typically polycarbonate or acrylic) are commonly used to create shielding where transparency is also desired. These rigid plastic films are available either water-clear or tinted.
- **Flexible Film** – UV-blocking, flexible urethane films can be used to quickly create workstation shielding. This UV-blocking, flexible urethane film is available from DYMAX.

HIGH-TEMPERATURE SURFACES

Surfaces exposed to high-intensity curing lights will rise in temperature. The intensity, distance, exposure time, cooling fans, and the type/color of the surface can all affect the actual surface temperature. In some cases, exposed surfaces can reach temperatures capable of producing a burn or causing damage to a substrate. In these cases, care must be taken to ensure a more moderate surface temperature or appropriate protection/training for operators.

OZONE

Standard DYMAX bulbs (UVA type) generate an insignificant amount of UVC and therefore essentially no ozone. Some UV light-curing systems, like those used to cure UV inks, emit primarily “shortwave” (UVB and UVC) energy. Upon exposure to UVC light (specifically <240 nm), oxygen molecules (O₂) split into oxygen atoms (O) and recombine with O₂ to create ozone O₃. The current, long-term ozone concentration limit recommended by ACGIH, NIOSH, and OSHA is 0.1 ppm (0.2mg/m³).

BRIGHT, VISIBLE LIGHT

The bright, visible light emitted by some UV light-curing systems can be objectionable to some workers and can cause eyestrain. Tinted eye protection and/or opaque/tinted shielding can be utilized to address this concern.

SUMMARY

UV light sources can be more “worker friendly” than many commonly accepted industrial processes, provided the potential concerns are addressed. Contact your DYMAX representative for information regarding the proper use of DYMAX UV light-curing systems.

GENERAL

The BlueWave® 50 is a high-intensity, UV light-curing Spot Lamp used for the curing of adhesives, coatings, and potting materials. It emits an UV light from a Lightguide. This guide can be hand-held for complete mobility, clamped into position for repetitive operations, or in automated equipment.

The unit consists of an anodized aluminum Housing, containing a Transformer Power Supply, Circuit Protection, Bulb/Reflector Assembly, Internal Light Filter for extended Lightguide life, Thermostatically-Controlled Cooling Fans, Lightguide Mount, Bulb Status Indicator Light, non-resettable Hour Meter, and Shutter system. The Lightguide is separate and plugs into the Lightguide Holder.

WARNING: Engage the Lightguide in the Lightguide Mount before the light is turned on and remove the Lightguide from the Lightguide Mount ONLY AFTER the light is turned off to avoid the possibility of exposure to the UV light. Lightly tighten the Setscrew for safety.

AVERTISSEMENT: Engager le guide de lumière dans le biseau avant la lumière est allumer, et enlève le guide de lumière de le biseau SEULEMENT après la lumière est fermer pour éviter la possibilité d'exposition à la lumière. Reserrer doucement la vis pour sécurité,

The Bulb Status Indicator Light above the Lightguide Mount lights when the Bulb is operating. If the Bulb extinguishes due to a momentary power failure, the unit must be turned off, allowed to cool, and then turned back on again to re-ignite the Bulb.

A Cooling Fan is provided to keep the Bulb Housing and internal components of the Power Supply at the optimum operating temperature. The Cooling Fan must not be covered or otherwise blocked. Fan Filters should be changed or cleaned frequently to prevent blockage and reduced ventilation airflow. The Power Supply operates on line voltages of 230V_{AC} 50Hz or 115V_{AC} 60Hz (factory set).

The UV source is a 50-Watt short-arc mercury-vapor Bulb mounted in a Reflector and pre-focused to provide optimum light output. The unit is rated for continuous operation.

SPECIFICATIONS

Specification	PN 38920	PN 38925
Voltage	230 Vac., 50Hz	115 Vac., 60 Hz
Current	1 Amp	2 Amp
Fuse	F2 Amp	F3 Amp 5 x 20 mm IEC 127
Bulb/Reflector	50 Watt (pre-focused)	50 Watt (pre-focused)
Shutter Timer	. 01 to 99.9 sec. electronic programmable	. 01 to 99.9 sec. electronic programmable
Foot Switch	Rocker type	Rocker Type
Hour-Meter	LCD, bulb hours	LCD, bulb hours
Dimensions (L X W X H)	12.0" X 12.25" X 6.5" (30.5cm X 31.1cm X 16.5cm)	12.0" X 12.25" X 6.5" (30.5cm X 31.1cm X 16.5cm)
Weight	21 lbs. (9.5 kg)	21 lbs. (9.5 kg)

Wavelength	Output Intensities (Typical)**†
320-390 nm	3.0+ W/cm ²
390-450 nm	3.5+ W/cm ²
280-320 nm	1 W/cm ²

** Measured with an EIT Spotcure Radiometer or Accu-Cal 50 radiometer using a Lightguide Simulator and standard internal "Cool Blue" filter.

† Operating the unit at less than rated input voltage may yield less output intensity.

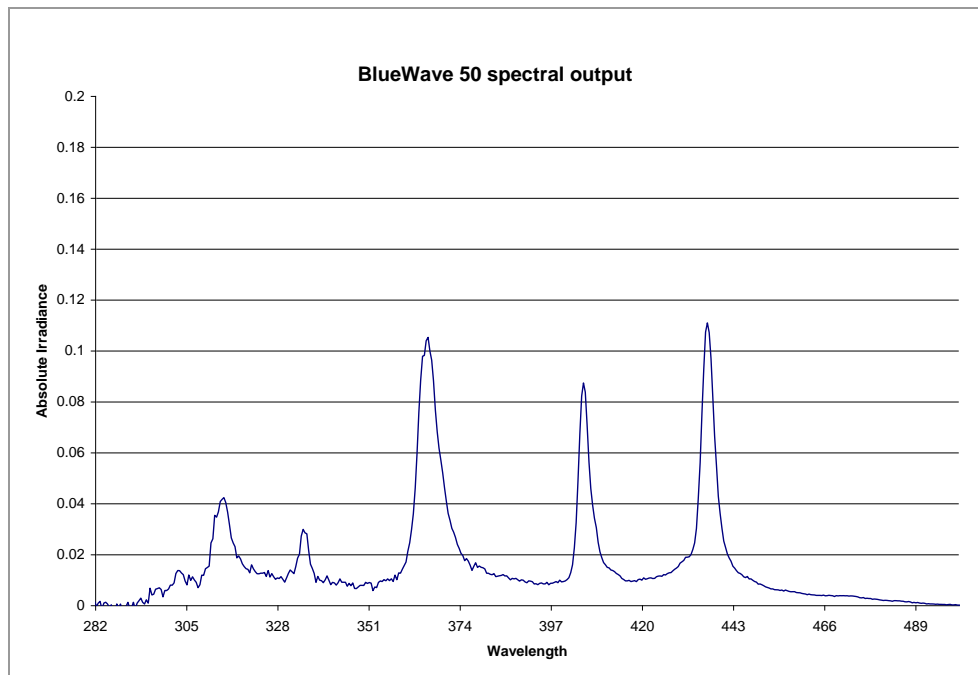

Figure 3. 50W Spectral Chart

INSTALLATION AND SYSTEM INTERCONNECT

1. Connect the Power Cord to the Power Receptacle on the rear of the unit and plug the Power Cord into a grounded wall outlet.
2. Connect the Footswitch to the Footswitch Connection (Figure 4) in the rear of the unit.
3. Remove the protective cover from the BlueWave® 50's Lightguide Mount (Figure 5).

NOTE: Always have a Lightguide or the protective cap engaged in the Lightguide Mount. UV light can escape when the Shutter is activated.

4. Remove the protective end caps from the Lightguide. Visually inspect the two ends of the Lightguide to verify that no foreign material is present. The ends of a DYMAX liquid-filled Lightguide can be cleaned with isopropyl alcohol as required to remove foreign material and deposition from outgassing.
5. Insert the large end of the Lightguide into the Lightguide Mount until it snaps into place (Figure 6).
6. If desired, the Lightguide may be fastened into place by lightly tightening the securing setscrew installed in the Lightguide Mount (Figure 6). A hex wrench is provided with the *BlueWave 50* for this purpose. The setscrew should be tightened gently to prevent damaging the Lightguide.

IMPORTANT! To ensure that proper output of the system is obtained, be sure to completely insert the Lightguide into the Lightguide Mount prior to tightening the Setscrew. Be sure to lightly tighten the Setscrew to ensure the Lightguide remains in place during use.

NOTE: Multi-leg Lightguides should be balanced by rotating the Lightguide to obtain the desired UV intensity of each leg before tightening the setscrew.

7. Turn the *BlueWave 50's* Power Switch on.
8. Allow the Bulb to warm up 4-5 minutes to obtain the maximum light output.

CAUTION: This is an arc, not a filament Bulb. Once ignited, it must be left on for a minimum of 10 minutes to fully vaporize elements in the Bulb. If not, the Bulb may be difficult to re-ignite. Each re-ignition increases the rate of Bulb degradation.

NOTE: The Bulb must cool before it can be re-ignited. Should the Bulb extinguish, leave the Power Switch on. This operates the Cooling Fan and allows the Bulb to re-light when it has cooled sufficiently. If the Bulb fails to ignite, refer to the Troubleshooting section of this manual. Bulb life is reduced approximately one hour each time the Bulb is switched on and off. Avoid repeated cycles that shorten Bulb life by leaving the unit on through breaks.

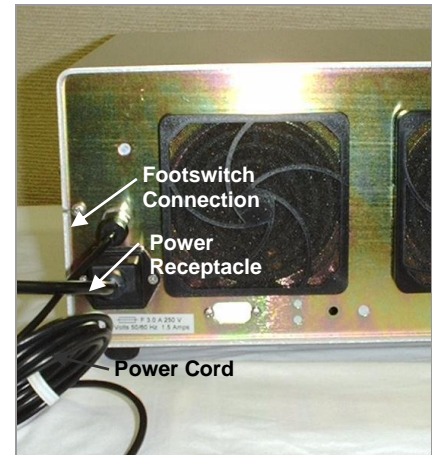

Figure 4. Cable Connection, *BlueWave 50* Rear Panel

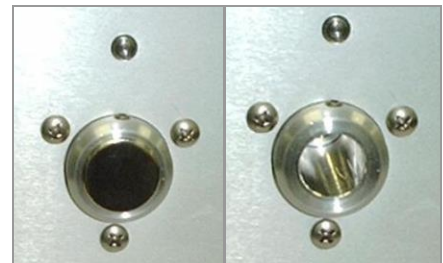

Figure 5. Lightguide Mount Protective Cover Installed (left); Protective Cover Removed (right)



Figure 6. Insert Lightguide into Lightguide Mount

- Operate the Shutter by pressing the Footswitch. With the Shutter Selector Switch in the manual position, the Shutter operates directly from the Footswitch. In the timed position, the Shutter opening is determined by the setting on the electronic Timer. Simply push the Timer Setting Buttons to enter the desired number of seconds the Shutter is to remain open.

BULB REPLACEMENT PROCEDURE

Bulb replacement is easily accomplished by following the steps below. Refer to the labeled diagrams under the light source cover.

- Ensure that the Power Cord is unplugged from the rear of the unit.
- If the unit was previously running, allow the Bulb to cool 10-15 minutes.
- Remove the top cover from the *BlueWave 50* by loosening the four cover fasteners.
- Disconnect the Bulb Plug (Figure 8).
- Loosen the two Thumbscrews and lift the Bulb Retaining Clip (Figure 8)
- Remove the Bulb Reflector Assembly (Figure 9).
- Install the new bulb by reversing steps 4 through 6.
- Reinstall the unit's cover and plug in the Power Cord.
- Turn the Power Switch on. The Bulb will now ignite. Allow the Bulb to warm up for 5 minutes. The unit is ready for use once the Bulb has warmed up.

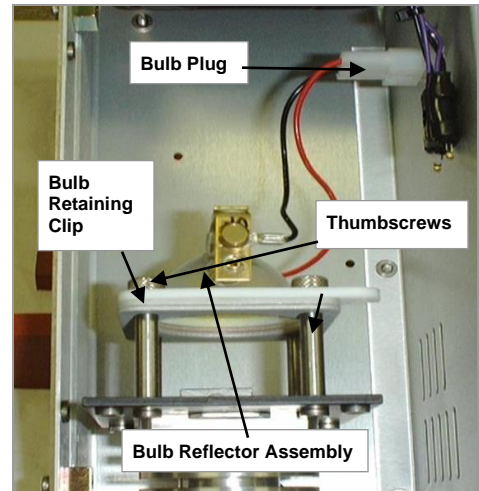

Figure 7. Bulb Assembly Components

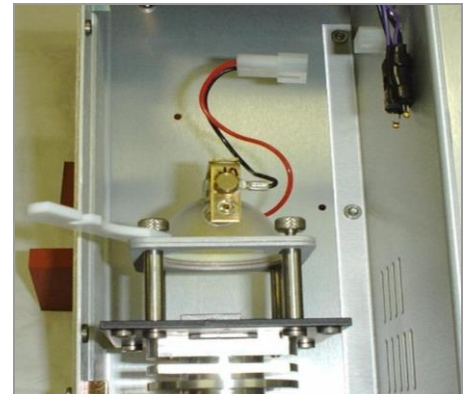

Figure 8. Bulb Removal

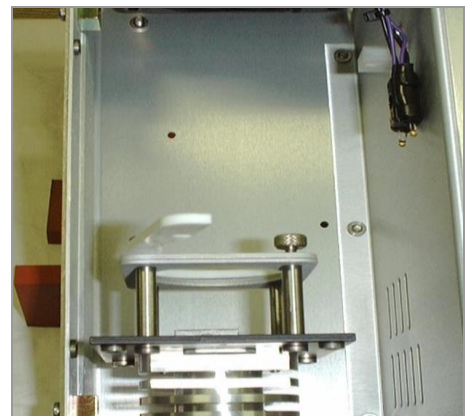

Figure 9. Bulb Reflector Removal

OPERATION

The BlueWave® 50 will arrive almost fully assembled. Please refer to the Installation and System Interconnect section of this manual for instructions on installing the Lightguide (sold separately), Power Cord, and Footswitch.

The system should be positioned in a dry location that does not obstruct airflow from the rear of the unit. To energize the system, turn the Power Switch from the “O” position to the “I” position (Figure 10). In the “I” position, the Fans, Hour Meter, Timer, and 50W Bulb should begin to function. This can be confirmed by viewing the illuminated Bulb Status Indicator Light above the Lightguide Mount (Figure 11). Before operating unit, allow the 50W Bulb to warm-up for approximately 5 minutes.

CAUTION: Always wear protective goggles or face shield when working near UV light. Never look directly at light exiting Lightguide.

PRÉ-CAUTION: Toujours porte lunettes de protection ou protéger de visage en travaillant près lumière ultraviolette. J’amais regarde directement à lumière sortie de le guide de lumière.

The Timer located on the front panel of the *BlueWave 50* is factory set to the most common operating mode and recommended operation of the Timer with the *BlueWave*. Some modes available on the Timer may not operate correctly with the *BlueWave* unit.

The front panel of the Timer contains a LCD Display and Keypad. The LCD Display has a Power Indicator, Signal Input Indicator, Reset Indicator, Gate Input Indicator, Key Protect Indicator, Output Indicator, Preset Value, Set Value, and Timing Operation Indicator. A brief description of each display and location:

- **Power Indicator** – Displays **PW** in upper left corner of Timer Display. Displayed when external power for operation is present.
- **Signal Input Indicator** – Displays **SIG** in upper left corner of Timer Display, located to right of Power Indicator. Displayed when activate signal is present.
- **Output Indicator** - Displays **OUT** in upper right corner of Timer Display. Displayed when Relay is switched to *NO*; is not displayed when Relay is switched to *NC*.
- **Present Value** – Four digits segmented display in center of Timer. Shows current status of time.
- **Set Value** – Four digit segmented display in lower right corner of Timer. Shows set length of time.
- **Timing Operation Indicator** – Displays **RUN** in upper right corner to the left of Output Indicator. Displayed when Timer is active.

To operate the Timer, select the “timed” option of the Switch on the front panel. Program the time into the Timer and depress the Footswitch. Factory settings will open the Shutter and the present value will begin to count backward. When the Timer reaches 00.00, it will reset the value to the set value and close the Shutter. The Timer cannot be stopped once it’s started. If the power is removed from unit, the Timer will reset to the set value.

To select the time, press the appropriate up key until the corresponding digit increments in the set value. By pressing the up key labeled (1), it will increment the left most digit on the Set Display. By pressing the up key (2),

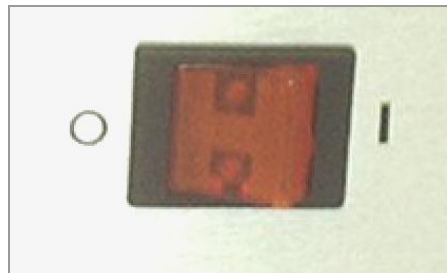

Figure 10. Power Switch



Figure 11. Bulb Status Indicator Light

it will increment the second digit of the Set Display. The same will happen with the up key (3) and the third digit of the Set Display, and up key (4) and the fourth digit of the Set Display. The Timer will increment from 9 back to 0. If the timer is not operating, the Timer should periodically update the present value with the set value; if Timer does not, press the Reset Button. Reset value will become the present value. The Timer comes programmed for a range of 00.01 seconds to 99.99 seconds. Consult the factory for other time ranges and functions.

UTILIZING A DYMAX FOOTSWITCH TO OPERATE THE BLUEWAVE® 50'S WITH A PLC

1. The Footswitch Receptacle located on the rear of the unit can be used to control the operation of the Shutter with a PLC.
2. The simplest way is to disconnect the Footswitch from the Cable. This frees up the Cable for use with a PLC.
3. To use a PLC, computer, or similar control device with the *BlueWave 50*, the Control Device must be isolated. Isolation can be achieved with use of a Relay. Most PLC's provide Relay outputs. Wire the Control Device to operate the Coils of the Relay. The Relay's Contacts must be rated to handle 12V 1A.
4. To open the Shutter turn on Q1, Q2, K1, or close S1 or S2.
5. As long as the Safety Contacts are closed (Q3 and Q4 turned on, K2 energized and S3 and S4 closed) the Shutter will open. Opening any Safety Contact will block Shutter activation but will not close the Shutter in "Timed" operation, only in "manual" operation.

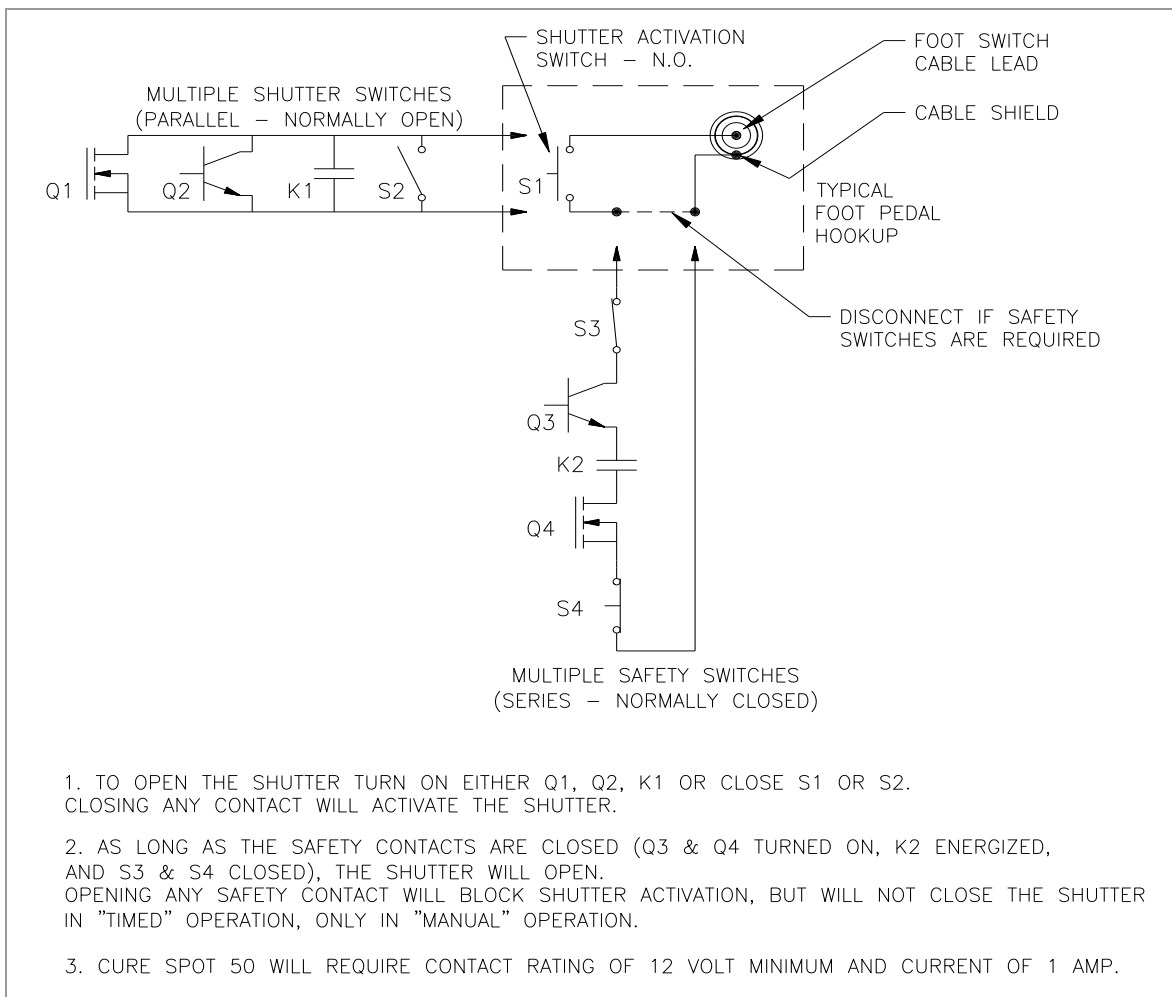

Figure 12. Exhaust Fans with Fan Filters Removed

MAINTENANCE

The BlueWave® 50 was designed to operate with minimum maintenance. Follow the schedule below to assure top performance from the unit.

LIGHTGUIDE

Clean the ends of the Lightguide monthly or as required. The ends of the Lightguide should be kept clean to transmit as much light as possible. Cured adhesive can be removed with a razor blade. Avoid sharp bends with the Lightguide since this reduces light output and damages guide.

FAN FILTERS

The external Fan Filters should be inspected and cleaned periodically to prevent dust buildup from affecting airflow through the unit. Spare Fan Filters are provided with each unit and with replacement Bulbs. The Fan Filters are washable and may be reused. Remove the Fan Filter by removing the snap-on cover from the rear of each grill.



Figure 13. Exhaust Fans with Fan Filters Removed

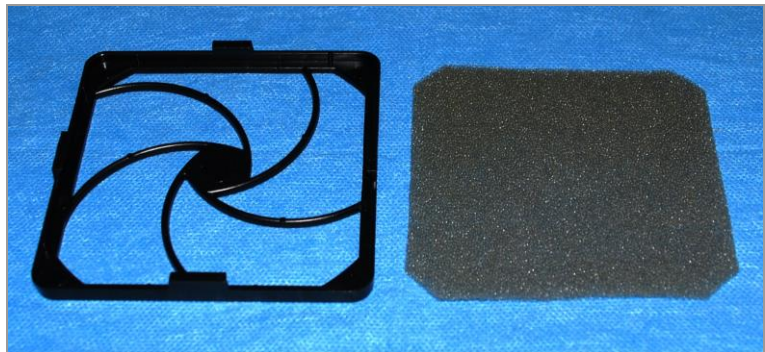

Figure 14. Disassembled Fan Filter

FUSE REPLACEMENT

The unit has two Fuses that are installed in the Power Receptacle. To remove the Fuses, unplug the unit and remove the Fuse Holder with a small screwdriver. Remove the Fuses from the Fuse Holder and install new Fuses. Replace the Fuse Holder into the Power Receptacle.



Figure 15. Power Receptacle



Figure 16. Fuse Holder

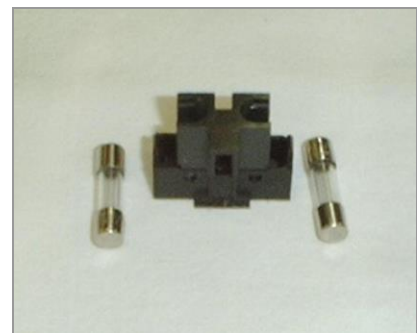

Figure 17. Fuses Removed from Holder

TROUBLESHOOTING

WARNING: Only qualified maintenance personnel should attempt the following procedures:

AVERTISSEMENT: Seulement personnel d'entretien diplômé devrais essayer les procedures suivant.

Problem	Possible Cause	Testing	Corrective Action
Bulb Will Not Ignite	Improper connections	Visually inspect all input/output connections (i.e. Power Cord, Bulb).	Secure all connections.
	Bulb beyond useful life of 2,000 hours	Replace with a new Bulb/ Reflector Assembly. Reset the Bulb Hour Meter and re-test unit.	Replace the Bulb/Reflector Assembly if required (typical life = 2,000 hours).
	Main line Fuse blown (nothing in unit operates)	Remove the Fuse from the Power Receptacle and check it with an Ohmmeter.	Replace the Fuse if defective.
Low Output Intensity or Fails To Cure Adhesive In Allotted Time	Bulb beyond useful life	Use a Radiometer (DYMAX ACCU-CAL™ 50 or equivalent) to measure output intensity.	Replace the Bulb/reflector assembly if beyond useful life (typical = 2,000 hours).
	Transmission loss in light guide too great	Compare Lightguide output against new Lightguide (or use the DYMAX Lightguide Simulator) to determine transmission loss.	Replace the Lightguide.
	Contaminants on Lightguide	Visually examine ends of Lightguide for contaminants.	Clean with isopropyl alcohol (or equivalent). Heavy deposits on liquid Lightguides may be removed with a razor blade. Replace Lightguide if it can not be cleaned.
	Bulb/Reflector Assembly not installed properly	Visually check to make sure the Bulb/Reflector Assembly is seated flush in the Bulb Mount Assembly (any error in installation could cause a low output).	Properly install Bulb/Reflector Assembly.

SPARE PARTS

ITEM	PART#
Bulb/Reflector Assembly	38915
Fuses: F3 Amp (for 115V Model)	35254
Fuses: F2 Amp (for 230V Model)	37236
Fan Filter and Holder	38587
Fan Filter Media	38659
Clip, Reflector Lower (PTFE)	38857
Clip, Reflector Upper (PTFE)	38858
Fan Assembly, including Thermistor	38625
Feet (Rubber Bumper)	38572
Filter, Bandpass	35986
Hour Meter	38908
Filter, Dual Fuse IEC Inlet	37178
PC-Board Filter Footswitch Assembly	38791
Shutter	38544
Solenoid Assembly	38628
Switch, Manual Timer	35384
Switch, Power	36288
Timer, Digital	36287

OPTIONS/ACCESSORIES:

ITEM	PART#
Case with Foam	38679
Liquid-D Lightguide, 5 mm X 1 Meter	5720
Liquid-D Lightguide, 5 mm X 1.5 Meter	5721
Liquid-D Lightguide, 8 mm X 1 Meter	5722
Liquid-D Two-Pole Lightguide, 3 mm X 1 Meter	38476
Liquid-D Three-Pole Lightguide, 3 mm X 1 Meter	38477
Liquid-D Four-Pole Lightguide, 3 mm X 1 Meter	38478
UV Goggles – Green	35286
UV Goggles – Gray	35285
Face Shield	35186
DYMAX ACCU-CAL™ Radiometer	36629
Lightguide Simulator	38408

DEFINITION OF TERMS

Bulb - Light source generating ultraviolet, visible, and infrared radiant energy from burning matter stimulated by electrical power conditioned by a proper power supply which is an integral part of a Lamp. A light source is usually placed into a Reflector (of various geometry) to increase light source efficiency by collecting and directing radiant energy of selected spectra (for a given curing process).

Intensity - A measure of light energy over the unit of surface area (usually surface at the specified working distance from the bottom of Reflector Housing) in W/cm^2 or mW/cm^2 . For the UV portion of light, this measure is often called in literature "irradiance", i.e. radiant energy arriving at a point on a surface per unit area.

Brightness, also known as Luminance - Description of energy in the visible region of the spectrum (approximately from 400 to 700 nm) and recorded in photometric units. "Intensity" (see below) of visible light energy is called Illuminance.

Illuminance - Luminous flux (energy of visible light) incident per unit area, and measured in Lx (lux) or Lumen/cm².

Ultraviolet (UV) - The invisible region of the spectrum just beyond the violet end of the visible region. Wavelength ranges in general from 1.0 to 400 nm. DYMAX bulbs (burners) do not radiate energy in deep ultraviolet; there are very minute amounts below 220 nm and practically nothing can be sensed below 200 nm. This is due to the use of ozone-blocking quartz Bulb Envelope (See Ozone).

1. **Ultraviolet A (UV-A)** - UV of long wavelength from within approximately 400 to 320 nm of the spectral band (4000 to 3200 \AA) - predominately produced by DYMAX Flood Lamps.
2. **Ultraviolet B (UV-B)** - UV of medium wavelength from within approximately 320 to 280 nm - DYMAX Flood Lamps produce some amount of their energy within this bandwidth.
3. **Ultraviolet C (UV-C)** - UV of short wavelength below 280 nm (we say from 280 to 200 nm) – a large amount of this energy is present in the sunlight.
4. **Visible** - Light that can be seen 400 to 700 nm.

Dose - Irradiance integrated over time, or Irradiance (W/cm^2) x Time (s) = Dose (Joules/cm²). Note: Watt is the power that gives rise to the production of energy at the rate of 1-joule (J) per second (s).

Ozone - oxidizing agent (O₃) produced by the action of Ultraviolet radiant energy (below 185 nm) or electrical corona discharge of oxygen on air.

OSHA 1910.145: "Regulation of Accident prevention Signs and Tags" defines the following headers as:

WARNING - Used when there is a hazardous situation that has some probability of severe injury.

CAUTION - Used to indicate a hazardous situation that may result in minor or moderate injury.

NOTICE - Used to convey a message related directly or indirectly to the safety of personnel, or protection of property.

OSHA 1910.145: "Regulation de la prevention d'accident Signes et Étiquettes" défin les têtes comme:

AVERTISSEMENT - est utiliser quand il ya un situation hasardeux qu'il avais de probabilité de se blesser sévère.

PRE-CAUTION - est user pour indiquer un situation hasardeux qu'il peut être en consequence en minueur ou modère blessure.

ATTENTION - est user pour communiquer un message lié directement ou indirectement à la sécurité de personnel, ou protection de propriété.

WARRANTY

Log-on to www.dymax.com/warranty for on-line warranty registration. This will insure that you are notified of any updates regarding this unit.

CAUTION!

DYMAX CORPORATION RESERVES THE RIGHT TO INVALIDATE ANY WARRANTIES, EXPRESSED OR IMPLIED, DUE TO ANY REPAIRS PERFORMED OR ATTEMPTED ON DYMAX EQUIPMENT WITHOUT WRITTEN AUTHORIZATION FROM DYMAX. THOSE CORRECTIVE ACTIONS LISTED BELOW ARE LIMITED TO THIS AUTHORIZATION.

DYMAX offers a one-year warranty against defects in material and workmanship on all system components, except the Bulb, *with proof of purchase date*. Unauthorized repair, modification, or improper use of equipment may void warranty. The use of aftermarket replacement parts not supplied or approved by DYMAX Corporation, will void any effective warranties and may result in damage to the equipment.

REPLACEMENT BULB WARRANTY

If the Bulb fails to ignite during the warranty period of 2,000 hours and all Bulb history cards for a specific BlueWave® 200 have been returned to DYMAX, the Bulb will be replaced under warranty.

NOTES



© 2006-2010 DYMAX Corporation. All rights reserved. All trademarks in this guide, except where noted, are the property of, or used under license by DYMAX Corporation, U.S.A. Please note that most dispensing and curing system applications are unique. DYMAX does not warrant the fitness of the product for the intended application. Any warranty applicable to the product, its application and use is strictly limited to that contained in DYMAX's standard Conditions of Sale. DYMAX recommends that any intended application be evaluated and tested by the user to insure that desired performance criteria are satisfied. DYMAX is willing to assist users in their performance testing and evaluation by offering equipment trial rental and leasing programs to assist in such testing and evaluation. Data sheets are available for valve controllers or pressure pots upon request.

MAN017 PN 38907 12/03/2010

Dymax Corporation
+1.860.482.1010 | info@dymax.com | www.dymax.com

Dymax Europe GmbH
+49 611.962.7900 | info_de@dymax.com | www.dymax.de

Dymax Engineering Adhesives Ireland Ltd.
+353 21.237.3016 | info_ie@dymax.com | www.dymax.ie

Dymax Oligomers & Coatings
+1.860.626.7006 | info_oc@dymax.com | www.dymax-oc.com

Dymax UV Adhesives & Equipment (China) Co. Ltd.
+86.755.83485759 | dymaxasia@dymax.com | www.dymax.com.cn

Dymax Korea LLC
+82.31.608.3434 | info_kr@dymax.com | www.dymax.com/kr

Dymax Asia (H.K.) Limited
+852.2460.7038 | dymaxasia@dymax.com | www.dymax.com.cn

Dymax Asia Pacific Pte. Ltd.
+65.6752.2887 | info_ap@dymax.com | www.dymax.com.cn