

UVCS LED Conveyors with BlueWave[®] AX-550 Arrays

User Guide

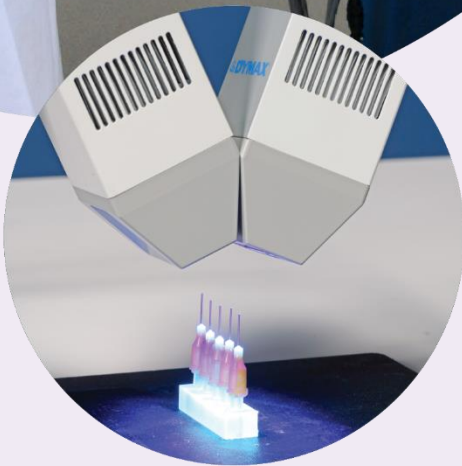



About Dymax

UV/Visible light-curable adhesives. Systems for light curing, fluid dispensing, and fluid packaging.

Dymax manufactures industrial, light-curable, epoxy, and activator-cured adhesives. We also manufacture a complete line of manual fluid dispensing systems, automatic fluid dispensing systems, and light-curing systems. Light-curing systems include LED light sources, spot, flood, and conveyor systems designed for compatibility and high performance with Dymax adhesives.

Dymax adhesives and light-curing systems optimize the speed of automated assembly, allow for 100% in-line inspection, and increase throughput. System designs enable stand-alone configuration or integration into your existing assembly line.

Please note that most dispensing and curing system applications are unique. Dymax does not warrant the fitness of the product for the intended application. Any warranty applicable to the product, its application, and use is strictly limited to that contained in the Dymax standard Conditions of Sale. Dymax recommends that any intended application be evaluated and tested by the user to ensure that desired performance criteria are satisfied. Dymax is willing to assist users in their performance testing and evaluation by offering equipment trial rental and leasing programs to assist in such testing and evaluations. Data sheets are available for valve controllers or pressure pots upon request.

Contents

Introduction	4
Where to Get Help.....	4
Safety	4
Product Overview	5
Description of UVCS LED Light-Curing Conveyors.....	5
Assembly and Setup	6
Unpacking and Inspecting Your Shipment.....	6
Parts Included.....	6
Setup	7
Conveyor Setup.....	7
Mounting the Flood System(s).....	7
Flood System Installation.....	8
Wiring LED Control Switch.....	14
Operating the Conveyor	16
LED System Height Adjustment.....	16
Operating the LED Light	18
Operating Modes.....	18
Adjusting Intensity.....	18
LED Operation.....	18
Validation.....	18
Cleaning and Maintenance	19
Belt-Tracking Adjustment.....	19
Conveyor Belt Replacement.....	19
Inspect and Replace Fuses.....	21
Glass Cleaning.....	21
Troubleshooting	22
Spare Parts and Accessories	23
Options/Accessories.....	23
Spare/Replacement Parts.....	24
Specifications	25
Definition of Terms	26
Index	27
Warranty	27

Introduction

This guide describes how to assemble, use, and maintain Dymax UVCS LED light-curing conveyor systems safely and efficiently when used with BlueWave® AX-550 arrays.

Intended Audience

Dymax prepared this user guide for experienced process engineers, technicians, and manufacturing personnel. If you are new to UV light sources and do not understand the instructions, contact Dymax Application Engineering to answer your questions before using the equipment.

Where to Get Help

Dymax Customer Support and Application Engineering teams are available in the United States, Monday through Friday, from 8:00 a.m. to 5:30 p.m. Eastern Standard Time. You can also email Dymax at info@dymax.com. Contact information for additional Dymax locations can be found on the back cover of this user guide.

Additional resources are available to ensure a trouble-free experience with our products:

- Detailed product information on www.dymax.com
- Dymax adhesive Product Data Sheets (PDS) on our website
- Safety Data Sheets (SDS) provided with shipments of Dymax adhesives

Safety



WARNING! *If you use this UV LED light source without first reading and understanding the information in the UV Light Safety Guide, SAF001, injury can result from exposure to high-intensity light. To reduce the risk of injury, please read and ensure you understand the information in that guide before assembling and operating the Dymax UV LED light source.*

Specific safety statements for this device:



This device falls under IEC 62471 Risk Group 3 for UVA and Blue Light emissions:

WARNING. *UV emitted from this product. Avoid eye and skin exposure to unshielded products.*

WARNING. *Possibly hazardous optical radiation emitted from this product. Do not look at operating lamp. Eye injury may result.*

Product Overview

Description of UVCS LED Light-Curing Conveyors

Dymax UVCS LED light-curing conveyor systems use high-intensity light sources for fast curing of light-curable materials. UVCS bench-top conveyors can be outfitted with BlueWave AX-550 LED flood systems available in one of three different wavelengths (365, 385, or 405 nm). The flood system consists of two main components: an LED flood array and a power supply that contains the user interface. Up to four LED flood arrays can be mounted on the conveyor.

BlueWave AX-550 flood systems feature an intensity adjustment, allowing the output intensity level to be adjusted from 10 to 100% to meet process and adhesive requirements. LED technology within the BlueWave AX-550 allows for instant on/off activation without the need for a warm-up period and is also rated for continuous operation. A switch on the conveyor is provided to keep the LED array always active.

Fans on the BlueWave AX-550 provide cooling and must not be covered or blocked. Thermal sensors in the system shut the unit down to protect the components if the internal temperature exceeds maximum limits. Please refer to the *BlueWave AX-550 Flood System User Guide* for further description and explanation.

All UVCS conveyors have adjustable belt speeds and lamp-to-belt distance to address a variety of application requirements. Standard height clearance is from 1.5 to 4.5 inches; optional risers increase clearance to either 6.5 or 10.5 inches.

Due to the weight of the BlueWave AX-550 systems, all two and four flood system configurations have a counterbalance strut installed for ease of height management.

When combined, the UVCS conveyors' consistent intensity, fast curing, and adjustable line speeds create an optimized light-curing process that enables high throughput.

Features & Benefits

- Complete UV shielding
- Controlled and consistent cure times
- Accepts parts up to 12" x 36"
- 4.5", 6.5", or 10.5" vertical clearance available
- 12" belt width (guides available to channel parts into center 6")
- Built-in exhaust fans with optional stack
- Multiple configurations of LED systems available
- Accurate digital belt control and readout
- Adjustable array-to-belt distance
- Built-in exhaust fans with optional stack
- Bench-top conveyor (with optional transportation carrying cart)

Assembly and Setup

Unpacking and Inspecting Your Shipment

Your UVCS LED Light-Curing conveyor will arrive in one or two crates. Inspect the crates and boxes for damage and notify the shipper of box damage immediately.

Open each box and check for equipment damage. If parts are damaged, notify the shipper and submit a claim for the damaged parts. Contact Dymax so that new parts can be shipped to you immediately.

Check that the parts included in your order match those listed below. If parts are missing, contact your local Dymax representative or Dymax Customer Support to resolve the problem.

Parts Included

- UVCS Conveyor with Cradle Assembly installed
- BlueWave AX-550 Flood System(s) (Controllers and Emitters)
Note: Refer to the BlueWave AX-550 User Guide for unboxing information
- UVCS LED Light-Curing Conveyor Systems User Guide (BlueWave AX-550 Lamps)
- UV Protection Goggles
- Accessories Per Custom Orders (exhaust duct, carts, or spare parts)

Figure 1.
Conveyor Components (Four-Array Configuration Shown)

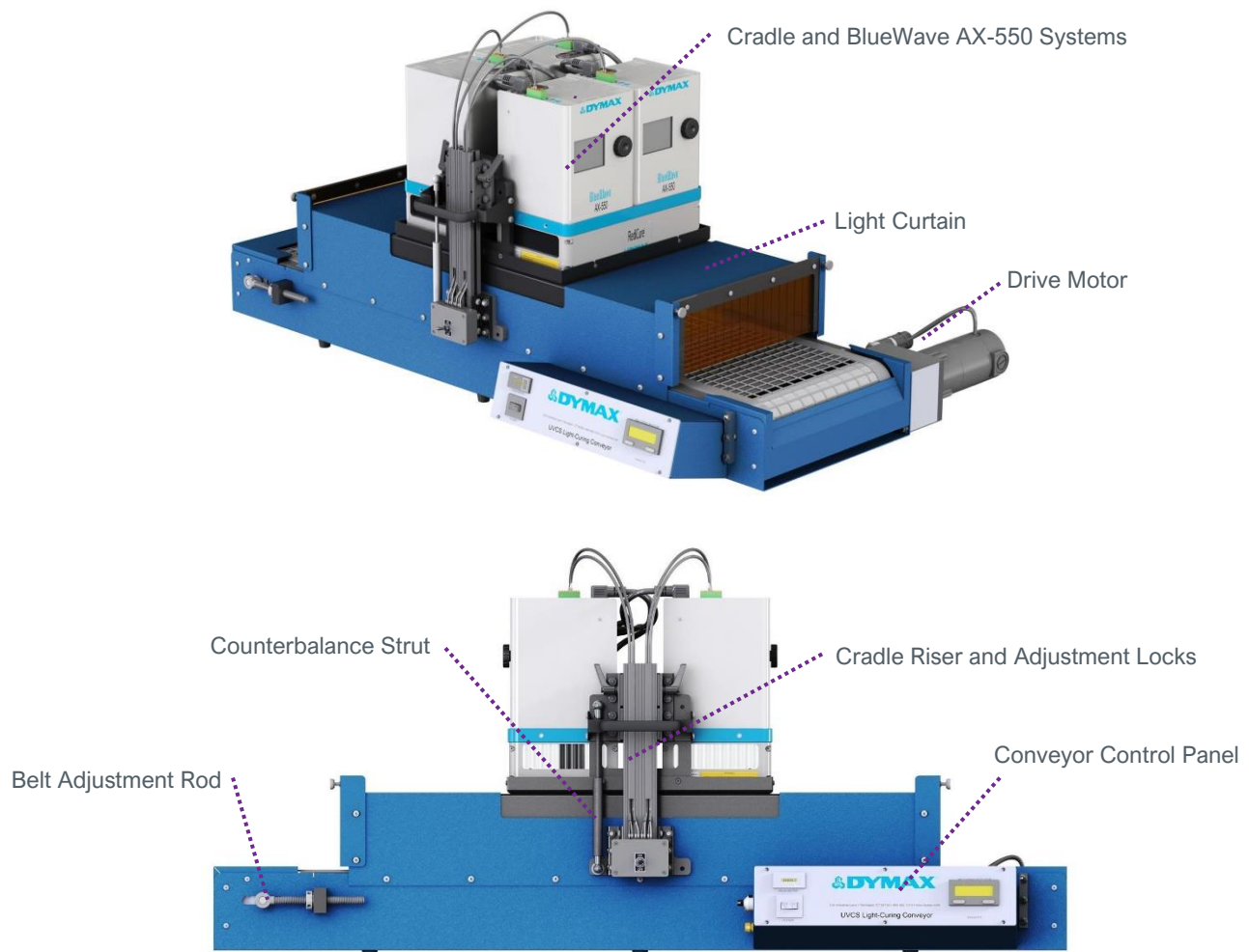

Setup

Conveyor Setup

1. Carefully remove all containers from the crate.
2. Remove the conveyor system last to prevent damage to other contents.
3. Remove the protective coverings from the conveyor. Place the conveyor on the conveyor rolling cart or on a stable work surface.
4. Unpack the BlueWave AX-550 flood lamp system(s). Each flood lamp system is comprised of a controller and emitter.

Note: It is recommended to assemble each flood lamp system and verify operation prior to installation onto the conveyor cradle.

Mounting the Flood System(s)

Up to four BlueWave AX-550 flood systems can be mounted onto your conveyor. The conveyor will be configured for mounting of the emitter and controller pairs at the factory.

Installation requires the mounting of the emitter first to the cradle and securing with provided fasteners and then the installation of the controllers onto the emitters with their supplied fasteners.

Note: Care must be taken when handling the emitters to protect the glass lens from damage or contamination.

Preparation

Verify your UVCS conveyor is on a stable platform for all production purposes.

After you have installed your unit, raise the cradle by turning the locking handles and sliding the cradle up the risers to a convenient working height (Figure 2).

Figure 2.
Raise the Cradle to a Convenient Working Height

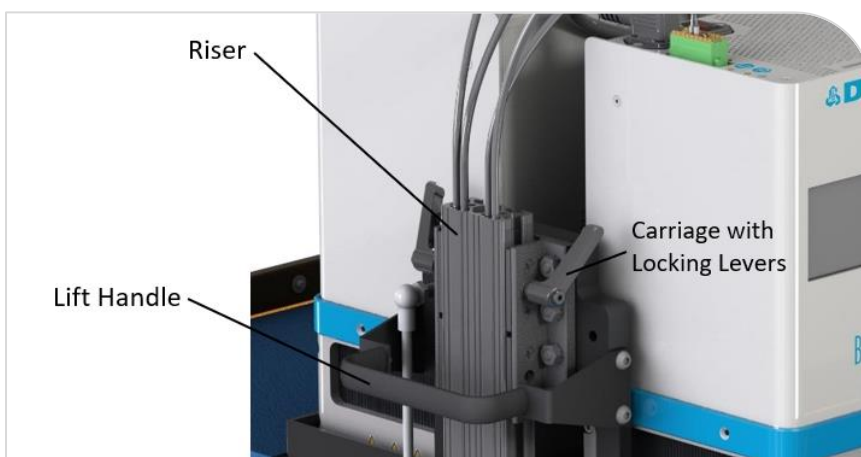

Flood System Installation

You will need to use the supplied Hex wrench and a small Philips screwdriver to install the BlueWave AX-550 systems.

All configurations have the cradle pre-assembled at the factory. Emitters are installed onto the cradle first and locked in place by screws prior to installing controllers. Some screws attaching controllers to emitters may not be used.

One Flood System

The emitter may be installed facing either direction, slots are provided on both uprights.

1. Align emitter holes with slots (Figure 3) and install the two screws using hex wrench firmly (Figure 4).

Figure 3.
Align Emitter Holes with Slots

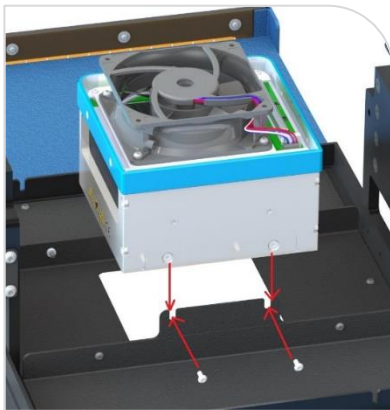
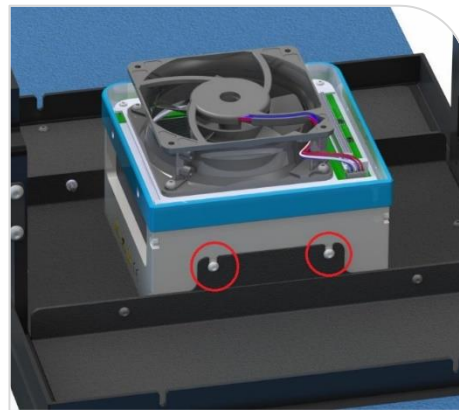
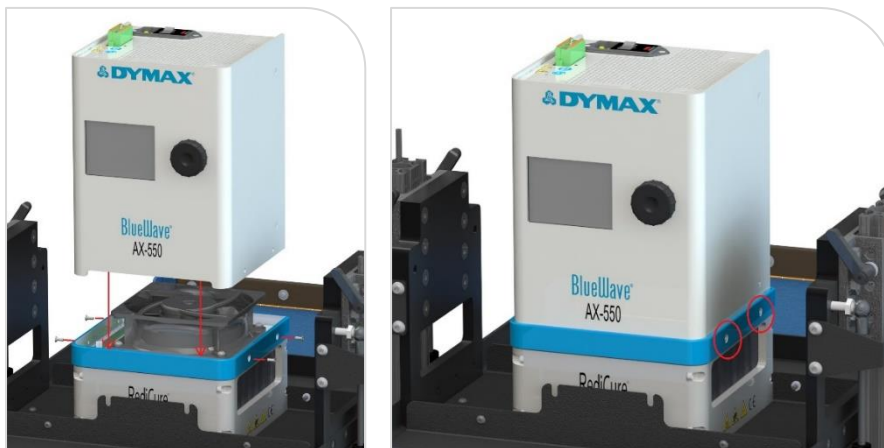

Figure 4.
Install Screws Using Hex Wrench



2. Align the controller with the emitter and drop into place ensuring proper alignment to prevent connector damage (Figure 5).
3. Install the four screws to attach the emitter using Philips head driver firmly.

Figure 5.
Align the Controller with the Emitter and Install the 4 Screws



Two Flood System

Two flood system configurations use a dual-emitter base structure to provide the best uniformity of UV energy at the target. The dual emitter can be configured in perpendicular or in-line with the conveyor travel direction.

In-Line Dual Emitter

1. Align the emitter base with the cradle opening and lower into place. Insert the supplied screws and tighten with the hex wrench at four locations.

Figure 6.

Lower Emitters into Cradle and Install the Four Screws

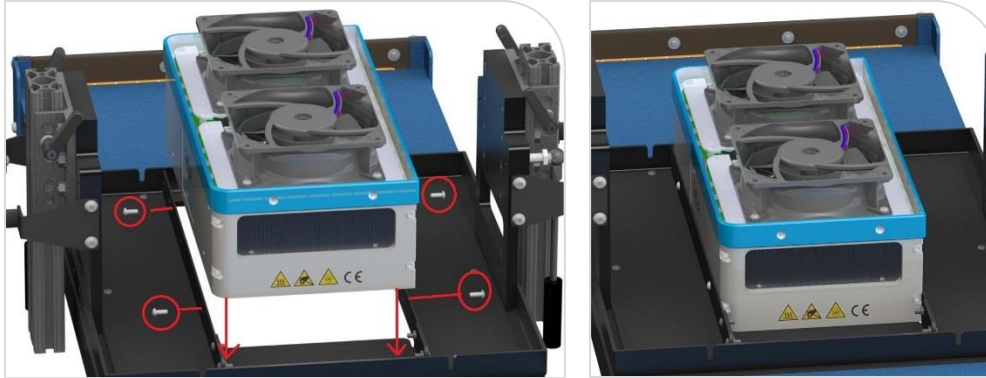

2. Next, lower the controllers onto the dual-emitter base, one at a time. Then, fasten each controller to the emitter base with two screws on each end, using the supplied hex wrench.

Figure 7.

Install the Controllers onto to Dual-Emitter Base



Perpendicular Dual-Head Emitter

For the best installation, it is recommended that the dual-head emitter be assembled with two controllers on the bare cradle.

1. Remove any shielding plates by removing the four mounting screws from the cradle and set aside.

Figure 8.
Remove Shielding Plates

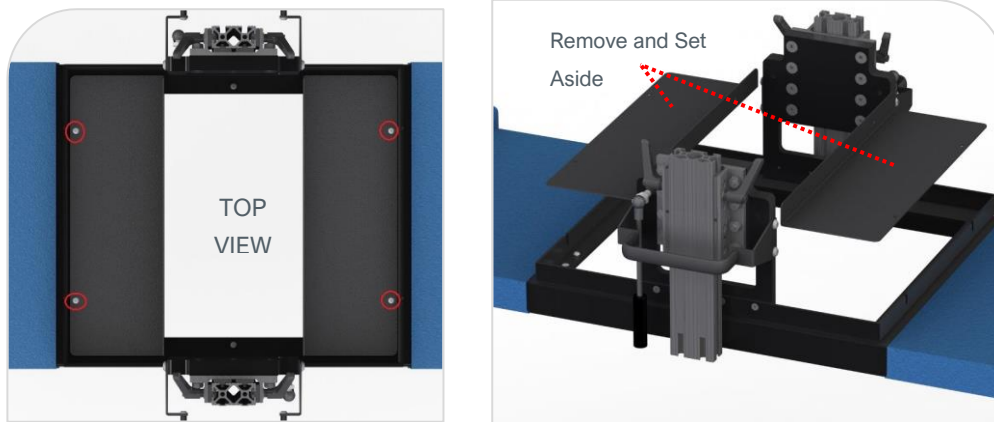

2. Place the dual-head emitter towards the front of the cradle (Figure 9).

Figure 9.
Place Emitter Towards Front of Cradle

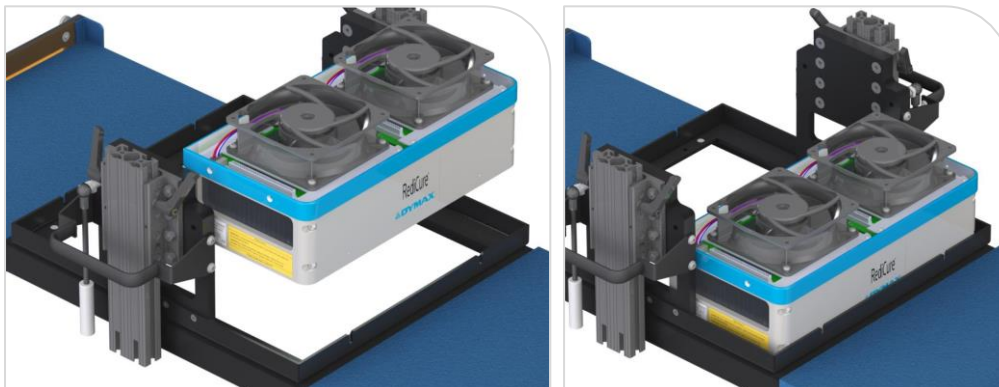

3. Lower the two controllers onto the emitters carefully (Figure 10).

Figure 10.
Lower Controllers onto Emitters



4. Install one screw on either side of the forward body of the emitter.

Figure 11.
Install Screws

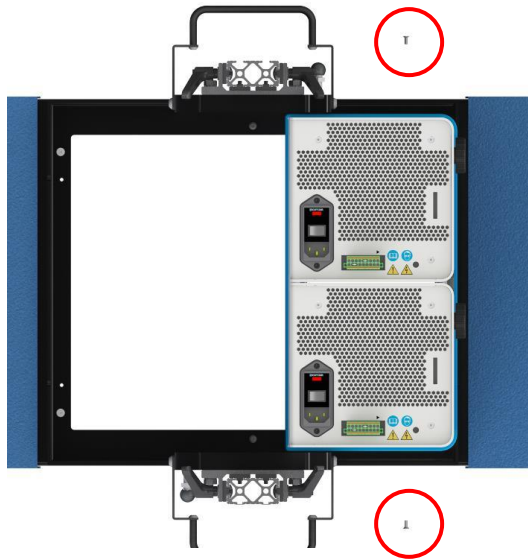

Figure 12.
Close Up of Screw



5. Use a screwdriver to tighten the screws and slide the assembly rearward to expose the rear screw locations.
6. Install the rear screws.

Figure 13.
Install Rear Screws

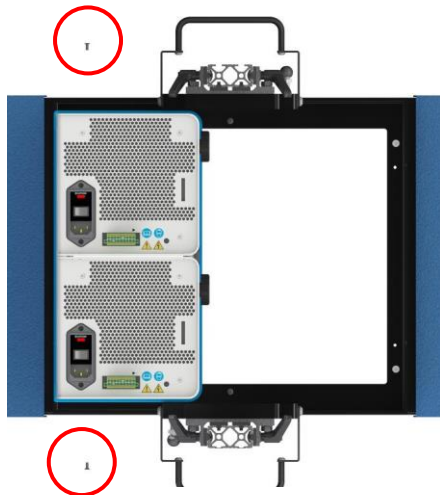
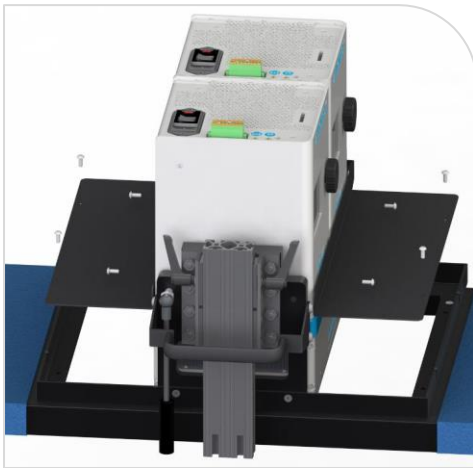

Figure 14.
Closeup of Rear Screw



7. Center the BlueWave AX-550 assemblies in the cradle to allow installation of the blocking plates.
8. Insert the blocking plates and attach them to the cradle with the screws and wrench supplied.
9. Attach the BlueWave AX-550 emitter to the plates front and back with screws and wrench supplied.

Figure 15.
Attach Emitter to Plates



Four Flood System

1. Lower the two dual head emitters onto the UVCS cradle.

Figure 16.
Lower the Dual-Head Emitters

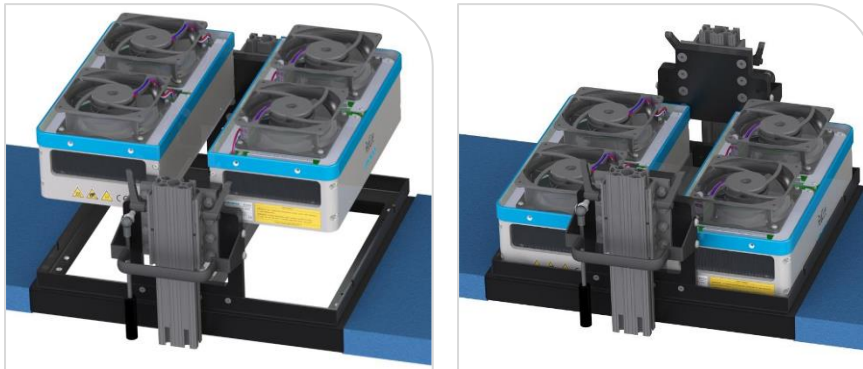

2. Install two screws to hold the emitter to the cradle on either end of the cradle.

Figure 17.
Install 2 Screws



3. Lower the controllers onto each emitter carefully.

Figure 18.
Lower Controllers on to Each Emitter



4. Install 4 side screws to stabilize the controllers on the emitters.

Figure 19.
Install 4 Screws

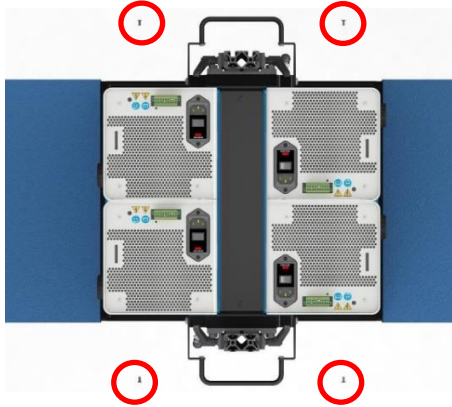

Figure 20.
Closeup of Screw



Wiring LED Control Switch

To control the BlueWave AX-550's ON and OFF states for irradiation, connect the trigger wires from the LED control switch to the TRIGGER pins on the BlueWave AX-550's terminal block trigger input. The terminal block has friction lock wire interface that will accept the crimped ferrule installed on the LED control wire assemblies by pressing them firmly into place.

Figure 21.
Insert Ferrule into Terminal

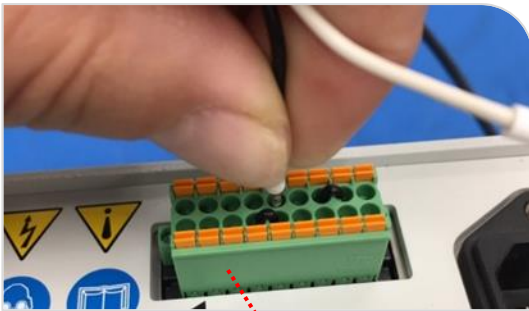

Terminal Block

Figure 22.
To Remove a Wire, Use a Small Screwdriver to Depress the Orange Lock Tab and Remove the Wire

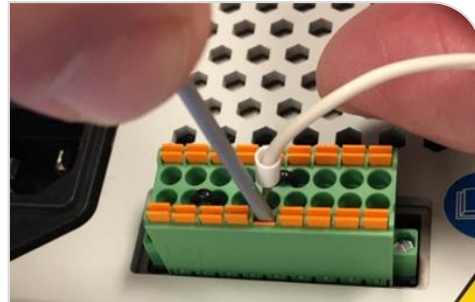
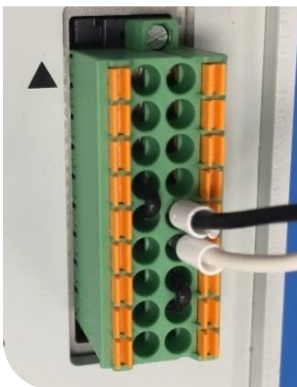

Figure 23.
Trigger Pins 13 and 14 Installed



FUSE			
F 10 A 250 VAC			
~100-240 VAC 50/60 Hz 10 A			
PLC CONNECTOR			
▲ SPARE	1	9	SPARE
SPARE	2	10	SYSTEM HEALTH
ANALOG INTENSITY	3	11	LED STATE
PLC GND	4	12	PLC ENABLE
MASTER INTERLOCK	5	13	TRIGGER COM
LED ON/OFF	6	14	TRIGGER
INTENSITY INT/EXT	7	15	LED INHIBIT
PLC PWR	8	16	COM
COM	A	B	COM

Figure 24.
LED Control Switch Wiring

LED Control
Wire Assemblies

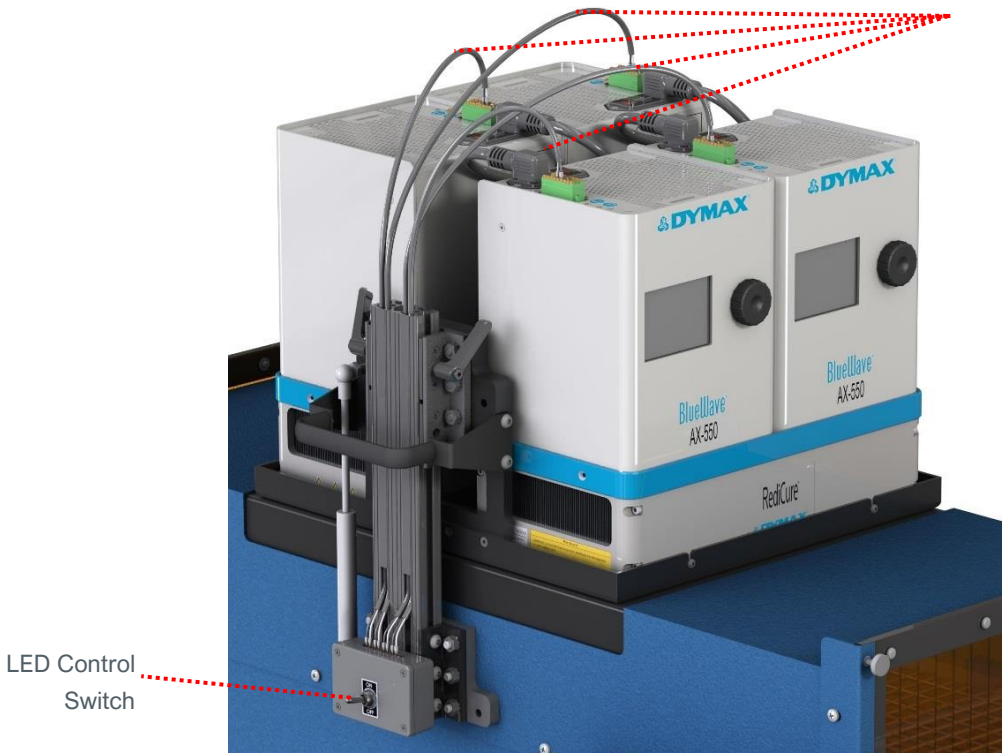
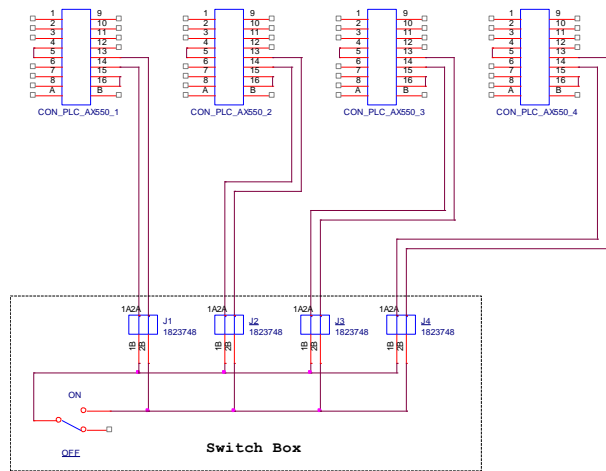

Figure 25.
Top View of BlueWave AX-550
Showing Terminal Block



Figure 26.
Schematic, Control Switch Wiring to Controllers



Operating the Conveyor

The conveyor and the BlueWave AX-550(s) each have a power cable that needs to be plugged into a wall outlet. The flood lamps have a power switch located on the top of the unit. The conveyor also has a power switch, located on the front panel. Plug in all the power cords and turn the conveyor on.

Figure 27.
Conveyor Control Panel, Front



Figure 28.
Conveyor Control Panel, Side



Conveyor belt speeds can be adjusted by turning the speed control knob, located on the side of the conveyor control panel. Belt speed is indicated on the speed display indicator. The belt speed knob is a ten-turn potentiometer and is equipped with a lock.

Belt speed performs two functions when curing:

- Provides a fixed exposure duration for irradiation of the target
- Allows fine tuning of cure process when using radiometric measurements

LED System Height Adjustment

The conveyor system uses a simple height management structure using a specially designed cradle and carriage system for ease of height adjustment. The main parts are shown below.

Figure 29.
Height Management Structure

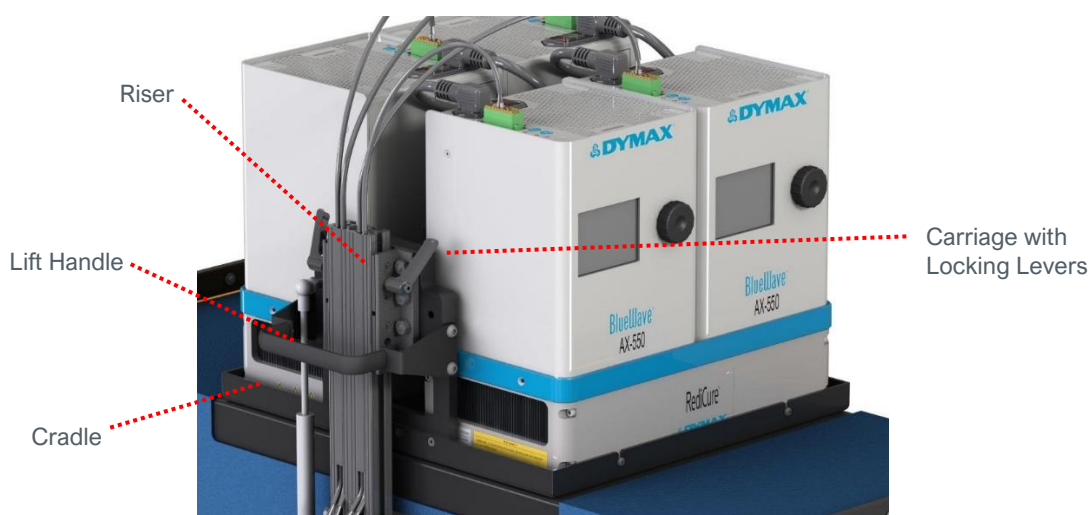

Adjustment

1. For single BlueWave AX-550 configurations, support the cradle with the handles prior to loosening the locking levers. For two and four BlueWave AX-550 configurations, the cradle is supported by struts to counter the weight and will not require support.
2. To adjust the height, loosen the locking levers on both sides of the riser and on both risers. This will allow the carriage to slide up and down the riser to the desired heights.
3. Clearance heights that are critical should be set using a measuring device or gauge inside the conveyor to ensure parts will not hit the inner tunnel.
4. Lift or press down on the handles to move the cradle up and down. Note that the struts will lift the cradle up on some configurations.
5. Level the heights of both sides of the cradle and tighten the locking levers on both risers firmly to ensure proper support and unit is locked in place.
6. Remove any measuring devices or gauges prior to starting the system.
7. Verify height setting and clearances prior to starting processes.

Height Range and Working Distance

Height Range

The conveyor tunnel clearance height maximum is 4.5" (114 mm) when the cradle is all the way up.

When the cradle is all the way down the conveyor tunnel clearance is 1.5" (75 mm).

Working Distance

The distance between the glass lens on the emitter and the belt is called the working distance. Since the emitter sits flush to the cradle the height adjustment range is also the working distance range.

Parts requiring smaller working distances than 1.5" (75 mm) should be placed on a palette of appropriate thickness to lift the workpiece off the belt and closer to the emitter.

Figure 30.
Cradle Clearance at Minimum & Maximum Height

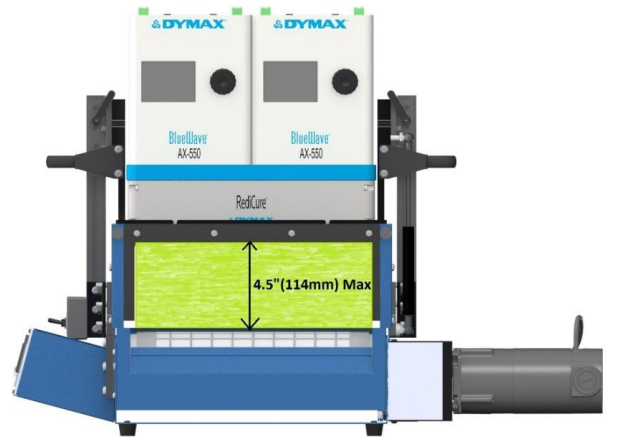

Cradle at minimum height
Tunnel clearance is 1.5" (38 mm)

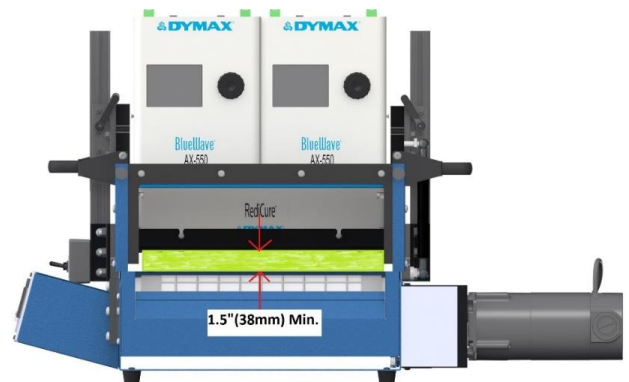

Cradle at maximum height
Tunnel clearance is 4.5" (114 mm)

Operating the LED Light

Operating Modes

There are three basic operating modes for the BlueWave AX-550 flood system: manual, timer, and PLC.

PLC and timer modes are not recommended for use with a conveyor.

Manual mode allows the user to activate the LED array with the use of a switch and cables to the TRIGGER port(s) on the top of the controller. The LED remains active only if the control switch is engaged.

When the control switch is turned to OFF the LED shuts off. Cables to connect the side mounted control switch are provided with each LED array system. This will allow the user to turn the array on and off using the side mounted control switch on the conveyor. Manual mode is recommended for use with a conveyor.

Please consult the [BlueWave AX-550 LED Flood System User Guide](#) for further details about each operation mode.

Adjusting Intensity

The output intensity can be adjusted from 10% (depending on the LED flood configuration ordered) to 100% in 1% increments. To adjust the intensity, refer to the [BlueWave AX-550 LED Flood System User Guide](#).

LED Operation

It is recommended that BlueWave AX-550 systems be set to manual mode for conveyor operation. Activate the flood lamps by actuating the switch on the side of the conveyor.

The LED system is instant-on and does not require preheating prior to use. Turning off the LED system between uses will extend LED life.

1. Ensure power cords for all flood lamps are securely in place. Power up each system and adjust the operating parameters.

2. Verify the LED control switch connections to the TRIGGER interface cables from the switch box terminals to each BlueWave AX-550 PLC port using the TRIGGER pin locations.
3. Actuate the LED control switch to turn ON all connected flood lamp systems simultaneously.
4. Once curing has completed, and the final part retrieved from the belt turn OFF the LED control switch.
5. Verify the conveyor is clear of all parts for curing prior to turning the conveyor off.

If the controller is set to timer mode, the LED control switch will toggle the LED array to turn on and it will turn off after the timer runs down. The LED array will not activate again until the LED control switch is toggled OFF and back ON.

Validation

Tests should be conducted prior to production to determine the time and light intensity required to fully cure your resin. The following approaches may be used to validate the curing process.

Set Exposure Time, Determine Intensity

Users can specify an exposure time and, through empirical testing, determine the intensity required and duration of exposure to achieve a full cure. Intensity can be adjusted using the front control screen on each LED Power Supply. Duration of exposure can be adjusted by adjusting the conveyor belt speed. As with any manufacturing process, it is advisable to incorporate a safety factor.

Control

Process validation confirms a minimum acceptable intensity. Users can then choose to operate at full intensity (using the excess intensity as an additional safety factor) or adjust the output to a specific intensity level. To ensure consistent and repeatable process results, intensity levels should be monitored with a radiometer. This enables users to identify changes in light intensity and take corrective action: either adjusting the light intensity or performing maintenance.

Cleaning and Maintenance

Belt-Tracking Adjustment

All Dymax UVCS conveyors are factory adjusted to provide proper tracking of the belt. Should further adjustments become necessary, there are two knurled adjustment knobs located at the input end of the conveyor (Figure 31). To adjust tracking, simply tighten the side to which the Belt is tracking.

NOTE: Do not over tighten the belt. This will lead to accelerated degradation of the belt. The belt should be stoppable with moderate hand pressure.

Figure 31.
Belt-Tension Adjustment Knob

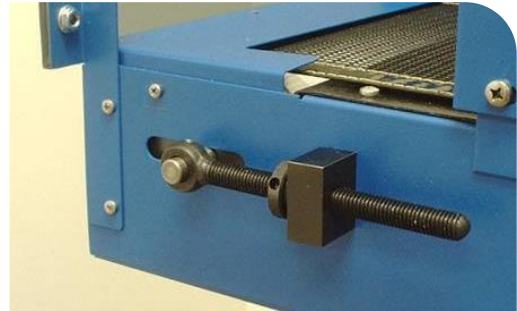

Conveyor Belt Replacement

1. Disconnect the conveyor system from the power source
2. Remove the pinch guard from the motor side of the conveyor by removing the two M4x8 screws (Figure 32) on the front side of the conveyor and the M4x25 screw (Figure 33) from the motor-drive side of the conveyor.
3. Remove the pinch guard from the input side of the conveyor by removing the three M4x8 screws (Figure 34) from both sides.

Figure 32.
Two M4x8 Screws



Figure 33.
M4x25 Screw



Figure 34.
Three M4x8 Screws



4. Remove all tension from the belt by fully backing off the belt-tension adjustment knobs (Figure 31).
5. Position the belt splice to the end of the conveyor (Figure 35). Remove the fiberglass rod that ties the ends of the belt together (Figure 36). Remove the belt.
6. Run the new Belt around the conveyor frame (Figure 37).
7. Install the fiberglass rod through the belt loops.
8. Apply some adhesive to both ends of the fiberglass rod to prevent it from moving during conveyor operation (Figure 38).

Figure 35.
Spliced End of Belt

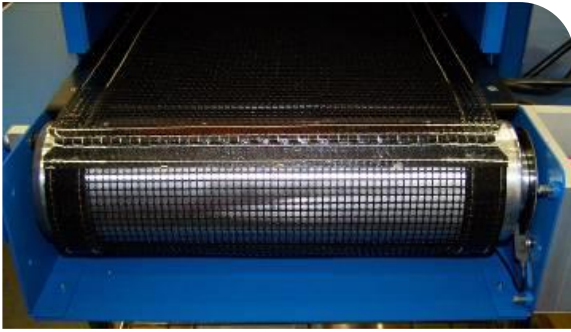

Figure 36.
Fiberglass Rod

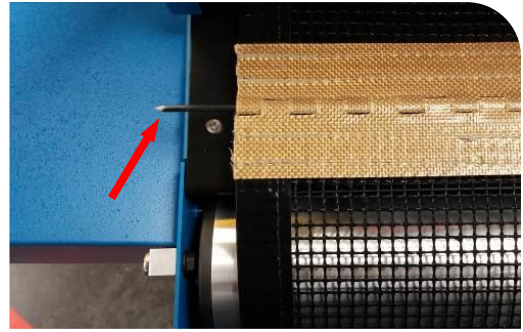

Figure 37.
Replacing Belt

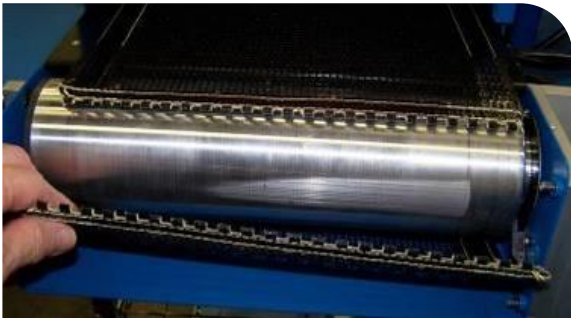
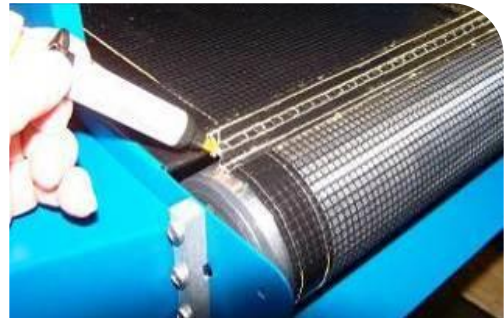

Figure 38.
Applying Adhesive



9. Equally tighten the belt-tension knobs (Figure 31) on both sides of the conveyor to remove excess slack from the Belt. Enough tension should be applied on the belt so that the belt can only be moved across the two rollers by moderate hand pressure when the conveyor is not running.

CAUTION! Excessive tightening of the belt will result in early belt failure. Since the two conveyor rollers have a crown in the middle, only minimum tightening is necessary.

10. Start the conveyor and adjust the belt-tensioning knobs (Figure 16) until the belt runs in the center of the loading end of the conveyor. There should be enough tension on the belt so that the Belt does not slip on the rollers, but loose enough so that it can be stopped by moderate hand pressure when the conveyor is running. If stopping the belt stalls the conveyor motor, the belt is too tight and must be loosened.
11. Monitor the tracking of the belt as the conveyor operates and use the belt-tensioning knobs (Figure 16) to make fine adjustments. To adjust tracking, simply tighten the side to which the Belt is tracking.
12. Reinstall the pinch guards on both ends of the conveyor. This step is critical to belt-speed sensor operation. The pinch guard on the unloading end of the conveyor contains a shield for the sensor to prevent damage if the belt contacts it while operating.
13. Verify that there is proper clearance between the belt's seam and the pinch guard (Figure 39). If the pinch guard is too close to the belt, contact Dymax for a replacement pinch guard.

Figure 39.
Verify Pinch Guard

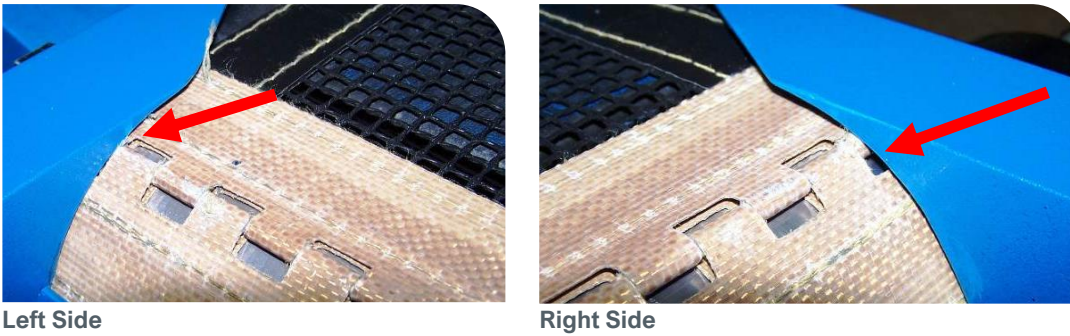

Inspect and Replace Fuses

The BlueWave AX-550 power supply has a fuse holder located on the top of the unit. Refer to the [BlueWave AX-550 User Guide](#) for instructions on replacing fuses.

Glass Cleaning

Periodic inspection for contamination on the emitter's glass lens should be performed to ensure proper operation.

1. Turn off the BlueWave AX-550 systems and allow to cool for 10 minutes prior to handling.
2. Remove the controllers from the emitters in reverse order of installation. Loosen the emitter mounting screws to be able to remove the emitters.
3. Turn the emitters over on a worktable being careful not to touch the glass lens surface.
4. Any contamination that is visible should be removed by cleaning with a lint free cloth and Isopropyl Alcohol.
5. Adhesive that is cured and adhering to the surface of the glass lens requires careful removal or replacement of the lens using a replacement kit.

Dymax Kits	
Quartz Optic Lens Single Head	43413
Quartz Optic Lens Dual Head Kit	43563

6. Once complete carefully reassemble the AX-550 units into the cradle and verify function prior to starting any curing processing.

Troubleshooting

The BlueWave AX-550 flood system constantly verifies its performance. If a problem is detected, a diagnostic screen is displayed. Refer to the [BlueWave AX-550 User Guide](#) for error code definition.

Please take note of the contents of the screen and contact Dymax for support.

Table 1.
Troubleshooting – BlueWave AX-550 Issues

Problem	Possible Cause	Corrective Action
Unit does not power up	The power cord is not plugged in or damaged	Check the connections and condition of the power cord
	The onboard fuse is blown	Check onboard fuse
	There is no electrical power at the receptacle	Test the receptacle for power
Unit powers up but LED is not producing light	The LED intensity adjustment is set to the minimum	Increase the LED intensity setting.
	Controller is not mated with emitter correctly	Recheck the BlueWave® AX-550 assembly for connection. Inspect for bent pins on the interface connector.
	The activation switch on the conveyor is not in the “on” position	Verify that they activation switch is in the “on” position
Unit is operating normally, and LED suddenly stops producing light	The over-temperature shutdown was triggered	Check that the flow of cooling air into the power supply or array is not restricted. If the LED does not illuminate after restarting, contact Dymax Application Engineering
LED array provides only low-intensity light	The LED intensity adjustment is set to the minimum	Increase the LED intensity setting
	The lens optics are contaminated/ dirty	Clean the surface of the lens
	Lamp height may have changed since last operated	Verify the lamp height and adjust as needed

Table 2.
Troubleshooting – Conveyor Issues

Problem	Possible Cause	Corrective Action
Conveyor not operating	Main line circuit breaker deployed	Toggle power switch off, then on, to reset the circuit breaker. Check the amp rating of the breaker. Compare it to specifications.
	Improperly fastened connections	Check all connections. Verify that the power cord is properly fastened.
	Fuses for motor controller blown	Remove the fuses from the fuse holders (located in the left side of control box) and check with an ohmmeter, replace if defective.
	Belt is hung up	Inspect the belt for any signs of a mechanical bind. Tighten the belt if it is slipping on the drive roller.
	Tension too low on belt (power switch lights and motor turns but belt does not move)	Use the tracking adjustment knobs to increase the tension on the belt. Both knobs should be turned the same amount to not affect the alignment.
Belt tracks to one side	Belt adjustment knobs are out of position	Tighten the adjustment knob (located on the side to which the belt is tracking towards) until the belt tracks straight. Only minor adjustments should be made at one time.

Spare Parts and Accessories

Options/Accessories

Item	Part Number
Personal Protection Equipment	
Protective Goggles — Green	35286
Protective Goggles — Gray (standard model included with unit)	35285
Face Shield	35186
Radiometers	
Dymax ACCU-CAL™ 160 (LED)	41585
Conveyor	
Exhaust Ducting Plenum	43625
Conveyor Rolling Cart Kit	39215
Riser Kit, 2"	39218
Riser Kit, 6"	39280
Circular Duct Adapter	43625

Spare/Replacement Parts

Item	Part Number
BlueWave AX-550 Key System Components	
Controller	43331
RediCure Emitter, 365 nm	43248
PrimeCure Emitter, 385 nm	43249
VisiCure Emitter, 405 nm	43250
RediCure Dual-Head Emitter, 365 nm	43549
PrimeCure Dual-Head Emitter, 385 nm	43550
VisiCure Dual-Head Emitter, 405 nm	43551
Quartz Optic Lens, Single Head	43413
Quartz Optic Lens, Dual Head Kit	43563
AC Power Cords	
Power Cord, North American	41274
Power Cord, China	41275
Conveyor Components	
Circuit Breaker, 115 VAC	39128
Curtain Assembly (2 Required)	39207
DC Motor Controller	40179
DC Motor Controller Resistor	40178
DC Motor Speed Indicator Sensor	39136
Gear Motor, 90 VDC	43391
Hour Meter	35981
Mesh Belt	39134
Mesh Belt, Fine	39772
Pinch Guard, Conveyor Discharge	39119
Pinch Guard, Conveyor Inlet	39118
Potentiometer, Conveyor Speed	40006
Red Lion Counter Timer 50020	39132
Red Lion 12V Power Supply	39133
Shield, Solid Acrylic (2 Required)	39205
Speed Controller Knob	40143

Specifications

Table 3.
Mechanical Specifications

	RediCure 365 nm Array			PrimeCure 385 nm Array			VisiCure 405 nm Array		
LED Array Voltage	90V - 260V			90V - 260V			90V - 260V		
# of Lamps	1	2	4	1	2	4	1	2	4
Width of Illuminated Area*	5" (13 cm)	CM – 5" (13 cm) FW – 10" (25 cm)	10" (25 cm)	5" (13 cm)	CM – 5" (13 cm) FW – 10" (25 cm)	10" (25 cm)	5" (13 cm)	CM – 5" (13 cm) FW – 10" (25 cm)	10" (25 cm)
Belt Speeds	0.8 – 32.0 ft/min [0.3 – 9.7 m/min]								
Belt Width	12" [30 cm]								
Vertical Clearance (Working Distance)	1.5" - 4.5" [38 mm - 114 mm] **								
Overall Dimensions (L x W x H)	50.5" x 30.5" x 22.0" [128 cm x 78 cm x 56 cm]								

* CM – Center Mounted FW – Full Width

** Larger part heights are achievable with the installation of optional riser kits.

Table 4.
Conveyor Electrical Specifications

Property	Specification	
Voltage Requirements	115 or 220 VAC, 50 or 60 HZ	
AC Current Values (Start/Run Current)	At 115 VAC 50/60 Hz	Total Conveyor - 4.8A / 2.4A rms Fans – 0.1 A max. Motor Control - 400 mA rms
	At 200-230 VAC 50/60 Hz	Total Conveyor – 2.4A / 1.2A rms Fan – 0.05 A max. Motor Control - 200 mA rms

Definition of Terms

Brightness, also known as **Luminance** - Description of energy in the visible region of the spectrum (approximately from 400 to 700 nm) and recorded in photometric units. “**Intensity**” (see below) of visible light energy is called Illuminance.

Dose - irradiance integrated over time, or Irradiance (W/cm²) x Time (s) = Dose (Joules/cm²).

NOTE: Watt is the power that gives rise to the production of energy at the rate of 1-joule (J) per second (s).

Flood Array System - set of components arranged to generate, collect, condition and direct UV radiant energy to perform curing of engineering adhesives, coatings, and inks within a safe and controlled process. It includes an array housing and power supply and may also include a shutter, workstation, UV enclosure, Dymax light shield, and/or accessories.

Illuminance - Luminous flux (energy of visible light) incident per unit area, and measured in **Lx** (lux) or **Lumen/cm²**.

Intensity - a measure of light energy over the unit of surface area (usually the surface at the specified working distance from the bottom of the reflector housing) in W/cm² or mW/cm².

Array – LED light source generating ultraviolet, visible, and infrared radiant energy from burning matter stimulated by electrical power conditioned by a proper power supply.

Ozone - oxidizing agent (O³) produced by the action of ultraviolet radiant energy (below 185 nm) or electrical corona discharge of oxygen on air.

Ultraviolet (UV) - The invisible region of the spectrum just beyond the violet end of the visible region. Wavelength ranges in general from 1.0 to 400 nm. Dymax Arrays do not radiate energy in deep ultraviolet; there are very minute amounts below 220 nm and practically nothing can be sensed below 200 nm. This is due to the use of ozone-blocking quartz bulb envelope (See Ozone).

Ultraviolet is used beneficially in various fields of industry and medicine. In order to standardize light sources used in medicine, the International Congress on Light, in Copenhagen in 1932, recommended dividing the ultraviolet spectrum into three spectral parts:

- Ultraviolet A (UV-A) - UV of long wavelength from within approximately 400 to 320 nm of the spectral band (4000 to 3200 \oplus) - predominately produced by Dymax flood arrays.
- Ultraviolet B (UV-B) - UV of medium wavelength from within approximately 320 to 280 nm - Dymax LED flood arrays produce some amount of their energy within this bandwidth.
- Ultraviolet C (UV-C) - UV of short wavelength below 280 nm (we say from 280 to 200 nm) – a large amount of this energy is present in the sunlight.

OSHA 1910.145: “Regulation of Accident prevention Signs and Tags” defines the following headers as:

- WARNING – is used when there is a hazardous situation that has some probability of severe injury.
- CAUTION - is used to indicate a hazardous situation that may result in minor or moderate injury.
- NOTICE - is used to convey a message related directly or indirectly to the safety of personnel, or protection of property.

Index

Adjustments	
Belt Tracking Adjustment	23
Intensity Adjustment.....	22
Lamp Height Adjustment.....	19
Assembly and Setup.....	7
Belt Replacement.....	23
Configurations	
1 Flood Lamp	9
2 Flood Lamps	10
4 Flood Lamps	14
Cradle	
Maximum Height.....	21
Minimum Height.....	21
Damaged Parts	7
Definition of Terms.....	30
Electrical Specifications	29
Flood Lamps	
Installation.....	9
Mounting.....	8
Operation.....	21
Fuses	25
Glass Cleaning.....	25
Glossary.....	30
Height Range	21
Help.....	4
LED Control Switch.....	15
Maintenance	23
Missing Parts.....	7
Operating Modes.....	21
Operation	18
Parts List.....	7
Product Overview.....	6
Safety	4
Setup	8
Spare Parts and Accessories	27
Specifications	29
Troubleshooting	26
Unpacking	7
Validation.....	22
Warranty	31
Working Distance	21

Warranty

From date of purchase, Dymax Corporation offers a one-year warranty against defects in material and workmanship on all system components (excluding LED array) with proof of purchase and purchase date. Unauthorized repair, modification, or improper use of equipment may void your warranty benefits. The use of aftermarket replacement parts not supplied or approved by Dymax Corporation will void any effective warranties and may result in damage to the equipment.

IMPORTANT NOTE: DYMAX CORPORATION RESERVES THE RIGHT TO INVALIDATE ANY WARRANTIES, EXPRESSED OR IMPLIED, DUE TO ANY REPAIRS PERFORMED OR ATTEMPTED ON DYMAX EQUIPMENT WITHOUT WRITTEN AUTHORIZATION FROM DYMAX. THOSE CORRECTIVE ACTIONS LISTED ABOVE ARE LIMITED TO THIS AUTHORIZATION.



www.dymax.com

Americas

USA | +1.860.482.1010 | info@dymax.com

Europe

Germany | +49 611.962.7900 | info_de@dymax.com
Ireland | +353 21.237.3016 | info_ie@dymax.com

Asia

Singapore | +65.67522887 | info_ap@dymax.com
China | +86.755.83485759 | dymaxasia@dymax.com
Hong Kong | +852.2460.7038 | dymaxasia@dymax.com
Korea | +82.31.608.3434 | info_kr@dymax.com

© 2019-2021 Dymax Corporation. All rights reserved. All trademarks in this guide, except where noted, are the property of, or used under license by Dymax Corporation, U.S.A.

Please note that most curing system applications are unique. Dymax does not warrant the fitness of the product for the intended application. Any warranty applicable to the product, its application and use is strictly limited to that contained in Dymax standard Conditions of Sale published on our website. Dymax recommends that any intended application be evaluated and tested by the user to ensure that desired performance criteria are satisfied. Dymax is willing to assist users in their performance testing and evaluation by offering equipment trial rental and leasing programs to assist in such testing and evaluations. PN 43603 MAN102DA 1/12/2021