

story
price list

january 2025

Laminate Selections

A three character sku identifies each laminate selection as well as the standard finish offered. Individual components are priced with standard finish on standard laminate.

A variety of Wilsonart® standard laminates with standard finishes is offered on conference and multipurpose tables. Additional colors may be available but are

subject to upcharges and extended lead times. The laminate option is available on components where noted as an option in the material specification code.

All laminate tops will have a 3mm matching edge band.

PLL Solid Laminate

Standard Solid

- 671 Designer White, Wilsonart D354-60 Matte Finish
- 672 Frosty White, Wilsonart 1573-60 Matte Finish
- 673 Fashion Grey, Wilsonart D381-60 Matte Finish
- 674 North Sea, Wilsonart D90-60 Matte Finish
- 675 Black, Wilsonart 1595-60 Matte Finish

20% Upcharge

- 665 Snow White Velvet, Wilsonart 15501-31 Traceless Laminate
- 666 Charcoal Velvet, Wilsonart 15504-31 Traceless Laminate
- 667 Black Velvet, Wilsonart 15505-31 Traceless Laminate

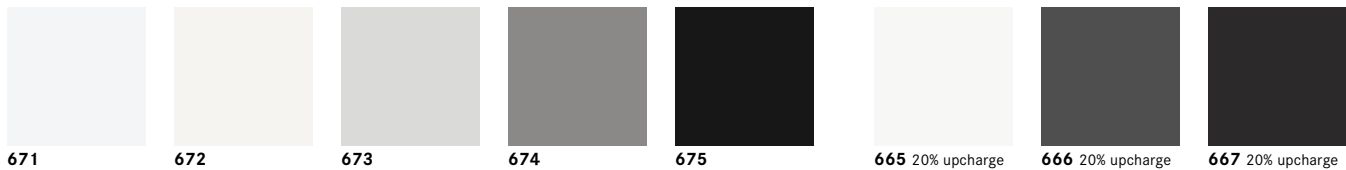

WGL Woodgrain Laminate

Standard Woodgrain

- 684 Phantom Pearl, Wilsonart 8211K-28 Gloss Line Finish w/Aeon Scratch Resistant Protection
- 685 Raw Chestnut, Wilsonart 7975K-12 Soft Grain Finish w/Aeon Scratch Resistant Protection
- 686 High Line, Wilsonart 7970K-18 Linearity Finish w/Aeon Scratch Resistant Protection
- 678 New Age Oak, Wilsonart 7938-16 Casual Rustic Finish
- 679 Brazilwood, Wilsonart 7946-38 Matte Finish
- 687 Boardwalk Oak, Wilsonart 7983-38 Fine Velvet Finish
- 683 Portico Teak (Grey), Wilsonart 8210K-28 Gloss Line Finish
- 681 Studio Teak, Wilsonart 7960-16 Casual Rustic Finish
- 680 Walnut Heights, Wilsonart 7965K-12 Soft Grain Finish
- 682 Asian Night, Wilsonart 7949-16 Casual Rustic Finish



Veneer Selections

A three character sku identifies each species as well as the standard finish offered. Individual components are priced with standard finish. Special finishes on veneers made to customer specifications are subject to factory approval and a 10% net upcharge with a \$500 net minimum.

Transparent stains and sealers are applied in multiple steps to enhance the beauty of the natural wood. A durable, baked-on, top-coat of conversion varnish

or UV topcoat is applied to protect the product. It is recommended that felt, cork or fabric backed desk pads and accessories are used on worksurfaces to minimize wear.

When specifying light finishes the natural characteristics of the wood will be visible and color will vary. Paint finishes are available as custom orders. See terms and conditions for additional finish information.

MPL Maple

Flat Cut

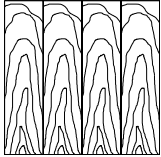

Standard Finish

- 871 860 861
- 837 836 823
- 865 805 866
- 872 839 845
- 870

OAK Oak

Rift Cut

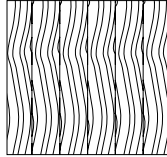

Standard Finish

- 871 870 839
- 837 860 861
- 865 836 866
- 872 805 845

Select Finishes

- M73 M72 M75
- M74 M76 M77
- M71

PLD Paldao

Quarter Cut

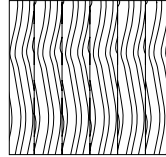

Standard Finish

- 871 860 823
- 872 861 866
- 870 839

WLT Walnut

Flat Cut

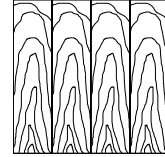

Standard Finish

- 872 861
- 870 823
- 860 866
- 839

MPL Maple



- 871 837 865 872 870 860 836 805
- 839 861 823 866 845

OAK Oak

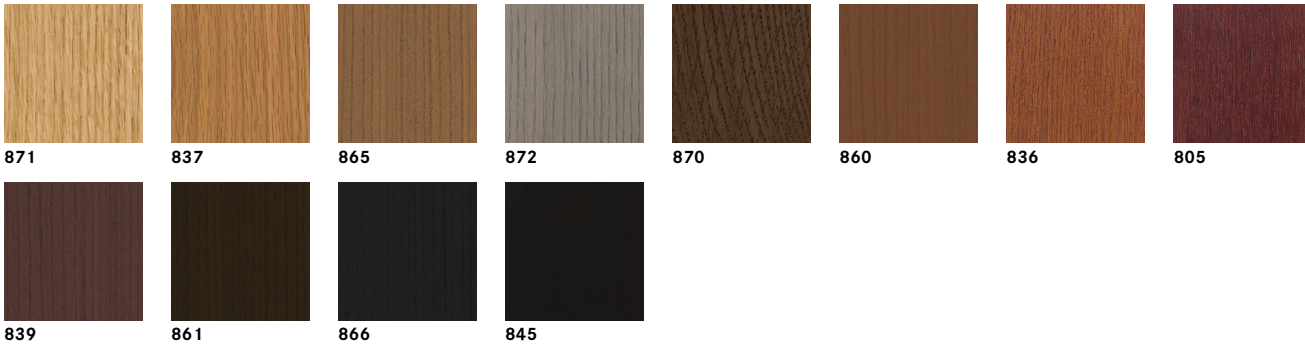

- 871 837 865 872 870 860 836 805
- 839 861 866 845

OAK Select Finishes



- M73 Whitewash M74 Fawn M71 Blonde M72 Toast M76 Caramel M75 Smoke M77 Coffee

Veneer Selections

PLD Paldao



871



872



870



860



861



839



823



866

WLT Walnut



872



870



860

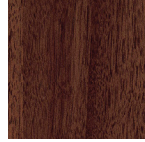

839

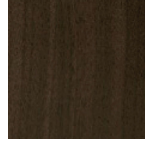

861

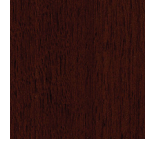

823



866

Edge Style Selections

Laminates



FL 1/4" Flat



RB 1/4" Reverse Bevel

Veneers

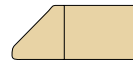

B1 1" Bevel



FL 1/4" Flat



RB 1/4" Reverse Bevel

Powder Coat Finishes

A two character sku identifies each powder coat finish offered. Individual skus are priced with standard metal finish. Non-standard finishes may incur an additional charge. The powder coat option is available on skus where noted as an option in the material specification code.

Standard Finish



PA Polished Aluminum

Powder Coat Finishes - **Upcharges apply.**

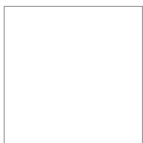

WH Satin White

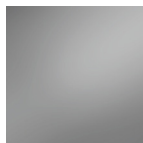

GR Graphite

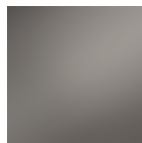

BZ Bronze



IG Iron Grey



RD Black Red



BK Matte Black

Optional Powder Coat Colors - RAL

- Lead Time - Three weeks additional lead-time after color approval
- Net Up-charge - \$1000 for colors shown in Bernhardt Design RAL Powder Coat Selector
- Minimum Order Quantity - None
- Approval Sample Cost - None
- Combining Products - One up-charge is applicable for multiple products on a single purchase order when they are in the same color

Story Table



Detail View of Story Leg



The Story table is available with a fixed or folding top. The 4-star aluminum base is available in polished aluminum and a variety of powder coat finishes. The base has adjustable levelers with 1/2" leveling range.

The Story base is available in a table height as well as a bar height. The base is appropriate for round or square tops ranging from 24" to 42" as well as a 30" x 24" rectangular top.

Story tops are specifically constructed to accommodate the Story table base. Tops are available with a flat, reverse bevel or bevel edge in round or square tops ranging from 24" to 42" and a 30" x 24" rectangular top.

SCS Indoor Advantage™ Gold and LEVEL® 2 certified. See terms and conditions for additional environmental information.

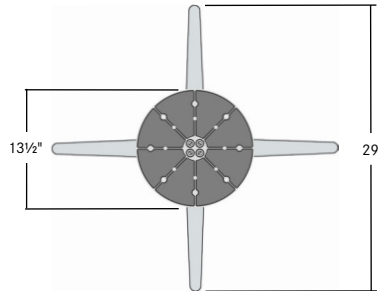

Plan View of Story Base

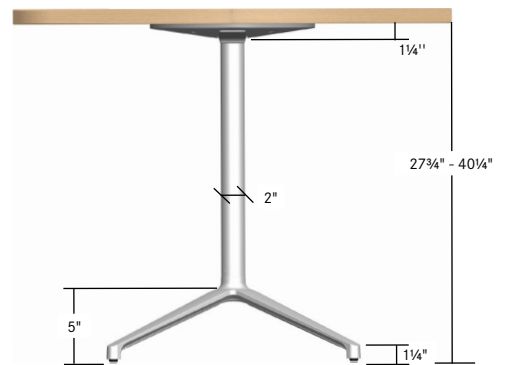

Elevation View of Story Base

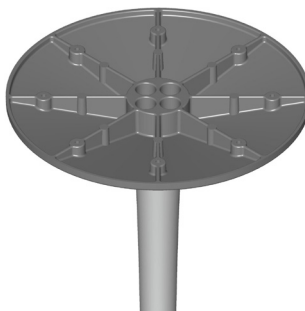

Fixed Base

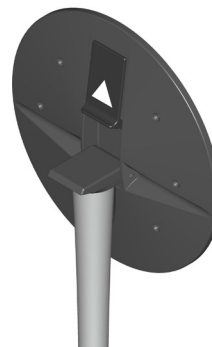

Folding Base with Latch Mechanism

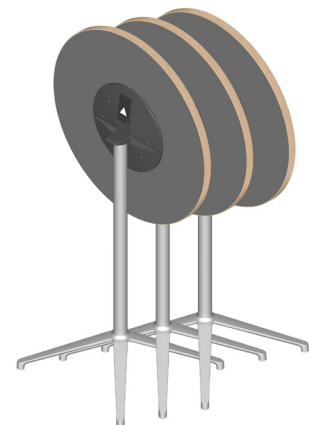

Nested Tables

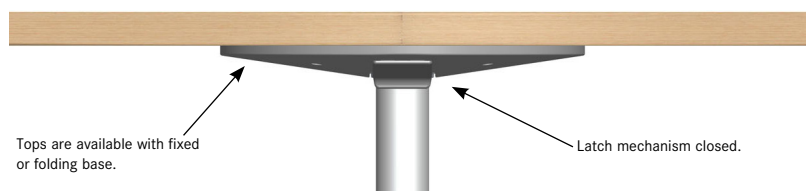

Tops are available with fixed or folding base.





Latch mechanism closed.

Detail view of the Story top with the folding base.



story bases

available in fixed or folding base in two heights
standard table height and bar height

description	sku	w	d	h	weight	specifications	price
 table height fixed	5FX	29	29	27¾	35	use with 24"-42" w tops	\$ 804
 table height folding	5FD	29	29	27¾	35	use with 24"-42" w tops	910
 bar height fixed	6FX	29	29	40¼	40	use with 24"-30" w tops	854
 bar height folding	6FD	29	29	40¼	40	use with 24"-30" w tops	960

specification codes example: STS-SKU

series	sku
story	
S T S -	

finish code example: PA

base finish
PA polished aluminum
powder coat upcharge \$150
WH satin white powder coat
GR graphite powder coat
BZ bronze powder coat
IG iron grey powder coat
RD black red powder coat
BK matte black powder coat



story tops
tops sold separately
order bases separately

PLL solid laminate WGL woodgrain laminate		MPL maple OAK oak WLT walnut		PLD paldao	

sku	l	d	weight	specifications					
round top									
YAY	24	24			\$ 793	\$ 1031	\$ 1366	\$ 1599	\$ 1585 \$ 1817
YAL	27	27			845	1099	1468	1718	1703 1953
YAX	30	30			899	1169	1683	1970	1953 2239
YAW	36	36		use with table height base only	950	1235	1889	2211	2192 2513
YAV	42	42		use with table height base only	1262	1641	2095	2452	2431 2787

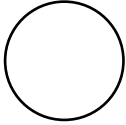

square top									
YBY	24	24			793	1031	1366	1599	1585 1817
YBL	27	27			845	1099	1468	1718	1703 1953
YBX	30	30			899	1169	1683	1970	1953 2239
YBW	36	36		use with table height base only	950	1235	1889	2211	2192 2513

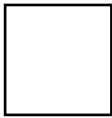

rectangular top									
YCD	30	24			900	1170	1683	1970	1953 2239

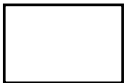

specification codes example: STS-SKU-B1

series	sku	edge
story		B1 1" bevel FL 1 1/4" flat RB 1 1/4" reverse bevel
S T S -	-	

material + finish code example:

material	finish
PLL solid laminate WGL woodgrain laminate MPL maple OAK oak WLT walnut PLD paldao	see pages 2-4

Prices and Specifications

Prices and specifications are subject to change without notice. All prices quoted will be FOB our factories. If applicable, sales tax will be based on ship-to destination.

Bernhardt Design reserves the right to make changes in dimensions, construction, price lists, or product literature without prior notice.

All measurements and weights are approximate and subject to change without notice.

Order Entry

All orders are subject to final acceptance by Bernhardt Design in Lenoir, NC. Receipt of our acknowledgment indicates acceptance of your order subject to the terms set forth on the acknowledgment.

Bernhardt Design attempts to clarify all purchase orders. However, in the event the price list number and description on the purchase order differ, the price list number will prevail.

Changes/Cancellation

All orders in production are considered firm orders and are not subject to changes or cancellation.

Shipping

Bernhardt Design will ship in accordance with customer instructions whenever possible. For convenience, Bernhardt Design offers a guaranteed freight program (GFP). Bernhardt Design will exercise our best judgment in selecting a carrier under our GFP. When selecting a carrier, Bernhardt Design will make our best effort to meet requested delivery dates.

Transportation lead-times and delays including equipment problems, weather, general traffic, traffic accidents, customer warehouse space, labor disputes, customer changes, etc., that occur on a carrier will not be the responsibility of Bernhardt Design. Furthermore, Bernhardt Design will not be responsible for additional costs incurred due to aforementioned delays.

For customers who decline our GFP, Bernhardt Design will stage orders for pick up at 1% of the list price, or \$75 minimum.

Customer orders in production will be shipped as scheduled and will not be held. Bernhardt Design reserves the right to make partial shipments on any order, unless notified otherwise by the customer.

High quality cartoning meeting trucking and railroad specifications is standard at no extra charge. Some items may be blanket wrapped for shipment.

Freight Damage and Claims

Bernhardt Design is not liable for any damages to products that occur during transit or storage. The carrier assumes all responsibility upon acceptance of product. It is the customer's responsibility to inspect products upon receipt and file any claims with the carrier. No product should be refused. If products are received damaged, a written exception should be made on the bill of lading and an immediate inspection be requested of the carrier.

Concealed damage must be reported to the carrier within 10 business days from date of delivery. Failure to make claims shall constitute acceptance of the products and waiver any claims of defects, errors or shortages.

In the event delivery is made on a Bernhardt Design truck, the products should be carefully inspected for transit damage. If contents are damaged, the driver should be notified to call his dispatcher for immediate disposition.

Concealed damage must be reported within 10 business days from date of delivery and product/packaging held for inspection by a Bernhardt Design representative. Replacements for product damaged in shipment or storage will be manufactured upon receipt of a purchase order.

Returns

No merchandise may be returned to Bernhardt Design without written consent in the form of a Return Authorization from our Quality Assurance Department stating why item is being returned and how item will be shipped.

Unauthorized returns will be automatically refused by our receiving department as well as returns not in accordance with Bernhardt Design shipping instructions. Liability for defective merchandise shall be limited to the replacement or repair of that merchandise, and Bernhardt Design shall not be liable for other damages or losses.

Terms and Credit

Pricing and terms of sale apply to orders accepted by Bernhardt Design, and no terms, stipulations, or conditions contained in the dealer's submitted purchase orders shall have any force or effect. Bernhardt Design requires a completed and signed credit application from every dealer. Bernhardt Design also requires dealers to provide a Blanket Certificate of Resale/Use containing valid sales tax exemption number(s) for their respective state(s).

If credit has been approved, the standard terms for all Bernhardt Design products are Net 30 from the invoice date. In certain instances, as an additional condition of order acceptance, buyer may be required to provide a deposit at time of order and/or remit the balance before shipment is released. If credit has not been approved, a 100% prepayment, including any freight charges, is required prior to production.

Acceptable forms of payment include a certified check or electronic bank transfer. For information on where to send check/electronic bank information contact our Financial Services Department. If a dealer or company check is submitted, three (3) weeks should be allowed for the clearance of the check. If electronic bank transfer is submitted, one (1) week should be allowed for the clearance of the electronic bank transfer. The order is subject to cancellation if payment in full is not received within three (3) weeks from the acknowledgment date.

The dealer may not make deductions for advertising, promotions, quality problems, freight, or any other reason without prior authorization by Bernhardt Design. Such a deduction could result in the curtailment or suspension of further shipments until the matter is resolved. Delinquency notices are generated and mailed periodically. Service charges of 18% per annum will be added to each past-due transaction. Unpaid service charges

will be accrued and invoiced on a periodic basis. Past-due notices may result in orders being held until the situation is resolved. This credit hold could prevent orders from being placed into production or shipped. Orders not in production that are placed on credit hold for three (3) weeks will be subject to cancellation.

Severe past-due situations may result in the employment of a collection agency or other collection litigation. If any collection activity is necessary regarding a dealer account, the dealer will be responsible for the payment of any and all attorney and collection agency fees.

A slow payment history may result in reducing or eliminating an open line of credit. At the discretion of Bernhardt Design, amounts owed by a dealer to Bernhardt Design arising from any transaction or dealings between the dealer and Bernhardt Design may be offset against any amounts owed to the dealer by Bernhardt Design.

Warranty

Bernhardt Design will repair or replace, at its discretion, any product or part thereof which fails as the result of defects in material and workmanship, under single shift use and normal care for five years from date of shipment. This warranty shall apply only to the original purchaser.

This warranty does not cover normal wear and tear, misuse or abuse of product, dramatic temperature changes, exposure to unusual conditions or damages incurred by contact with seating products, tables, desks or other surfaces. Natural color changes, variations or movements in lumber or veneer products, exposure to extreme temperature changes and direct sunlight may cause color changes and/or surface damage. These are circumstances beyond the control of Bernhardt Design and are not warranty issues. Repair or replacement of discontinued product will be at the discretion of Bernhardt Design.

This warranty is the customer's exclusive remedy for product defect and does not apply to damage caused by a freight carrier, dealer, installer, user modification, attachments to a product, or any third party. Bernhardt Design has the exclusive right to make the final determination of product misuse or abuse. Except as stated above, Bernhardt Design makes no express or implied warranties as to any product, and in particular, makes no warranty of merchantability or of fitness for any particular purpose. Bernhardt Design shall not be liable for any consequential or incidental damages or for commercial loss arising from any product defect.

Operational Parts Warranty

Drawer glides, drawer boxes, drawer pulls, and lock mechanisms have a Life-Time Warranty for original purchaser. Power and communication components are warranted for one year.

Parts Order

Bernhardt Design parts have a \$25 net minimum per order. This does not include freight costs.

Custom Design

Bernhardt Design may alter products to meet specific needs. Contact your local sales representative when a custom design is needed. Custom designs,

if approved, require minimum quantities, additional leadtime and upcharges. A custom job number, available from your Bernhardt Design sales representative, must be submitted with purchase orders.

Orders combining custom design with standard product cannot be scheduled for production until custom items are approved. Custom design orders are not subject to revision or cancellation after acknowledgment.

Wood Finishes

Bernhardt Design tables are available in finishes that are compatible with credenzas and seating finishes. However, finishes on tables may vary slightly from those on seating due to the natural characteristics of the wood. No absolute match is implied or guaranteed.

Light Finishes

Bernhardt Design offers lighter finishes on certain veneers and solid woods. When specifying light finishes the natural characteristics of the wood will be visible and color will vary.

Natural characteristics include the natural discolorations of the wood substance and color variations in glued up stock. These natural characteristics are not considered defects by Bernhardt Design, and therefore merchandise will not be replaced.

Special Finishes

Special finishes, made to customer specifications and subject to factory approval, may be available at a **10% net upcharge with a \$500 net minimum**.

Additional leadtime may be required for special finish items. Special finish orders will not be acknowledged until the special finish sample is approved in writing and received by Bernhardt Design Customer Service. Special finish orders are not subject to revision or cancellation after acknowledgment.

Installation and Maintenance

All freestanding tables and credenzas are equipped with leveling devices. Local floor conditions vary, and it is always necessary to properly adjust leveling devices. Proper leveling is essential to the alignment and function of doors and drawers.

Improperly leveled units result in misaligned doors and drawers and may impair locking mechanisms or other functional hardware.

After the initial installation of credenzas, it may be necessary to readjust and align the units to compensate for settling. This should be expected as a matter of routine maintenance and follow-up to assure proper case function.

Proper installation of Bernhardt Design tables and credenzas is the responsibility of the dealer. Improperly installed units can result in permanent damage to case components. Damage due to improperly installed furniture not covered under product warranty.

Orders combining custom design with standard product cannot be scheduled for production until custom items are approved. Custom design orders are not subject to revision or cancellation after acknowledgment.

Care and Cleaning

Finished wood surfaces should be cleaned with a soft damp cloth, wiping in the direction of the grain. Furniture should be buffed dry immediately with a soft cloth.

Design and Patent Rights

All of the products shown in Bernhardt Design catalogs and described in Bernhardt Design price lists are, and remain, the property of Bernhardt Design, with the sole right reserved to manufacture and to distribute.

Some of the product designs shown are patented in the United States and will remain the property of Bernhardt Design. Any reproduction of the products constitutes an infringement of patented copyright laws and will be subject to prosecution.

Environmental

Some tables and credenzas are LEVEL[®] for ANSI/BIFMA e3-2019 – Furniture Sustainability Standard and SCS Indoor Advantage[™] Gold certified. Visit the product page at bernhardtdesign.com for certifications.

Preferred Carrier Guaranteed Freight Rates

Freight charges will be applied to orders as a separate line item based on the zones listed. Rates are based on zones with a minimum for each zone. All zones are located within the Continental United States.

The freight amount is calculated on the total merchandise list COM price. Additional freight fuel surcharges may apply. Rates are based on deliveries made Monday through Friday, 8 am until 5 pm.

All orders are shipped by Bernhardt Design company trucks or preferred carriers specified by Bernhardt Design. **If a purchase order does not specify that the product must ship complete, Bernhardt Design reserves the right to select the most effective shipping method necessary, including split shipments.** Dealer warehouse information, including phone number and contact name, must be specified on the purchase order.

Zone	Percent	Minimum
Zone 1	3%	\$150
Zone 2	4%	\$150
Zone 3	5%	\$150
Zone 4	5.5%	\$150
Zone 5	6%	\$150

Percent bases on List Price.

Direct site deliveries may be requested with an additional freight cost. Requests for direct site deliveries must be made 2 weeks prior to the scheduled ship week and meet the following criteria:

- Minimum of half truckload
- Delivery site accessible by a 53' trailer
- Complete delivery site address with contact name and on-site phone number
- Labor available for unloading

Deliveries that do not meet the criteria must be directed to a receiver warehouse. If a receiver warehouse is not available, the dealer may make arrangements with their own 3rd party carrier. If a 3rd party carrier is elected, a contact name, phone number and e-mail address is required.

Bernhardt Design has a no touch freight policy. Drivers are not allowed to unload freight.

Weekend direct site deliveries will incur a \$500 per trailer weekend delivery fee. Weekend is defined as between 5 pm Friday and 8 am Monday.

Customers who decline GFP should refer to the shipping section of the Terms and Conditions page.

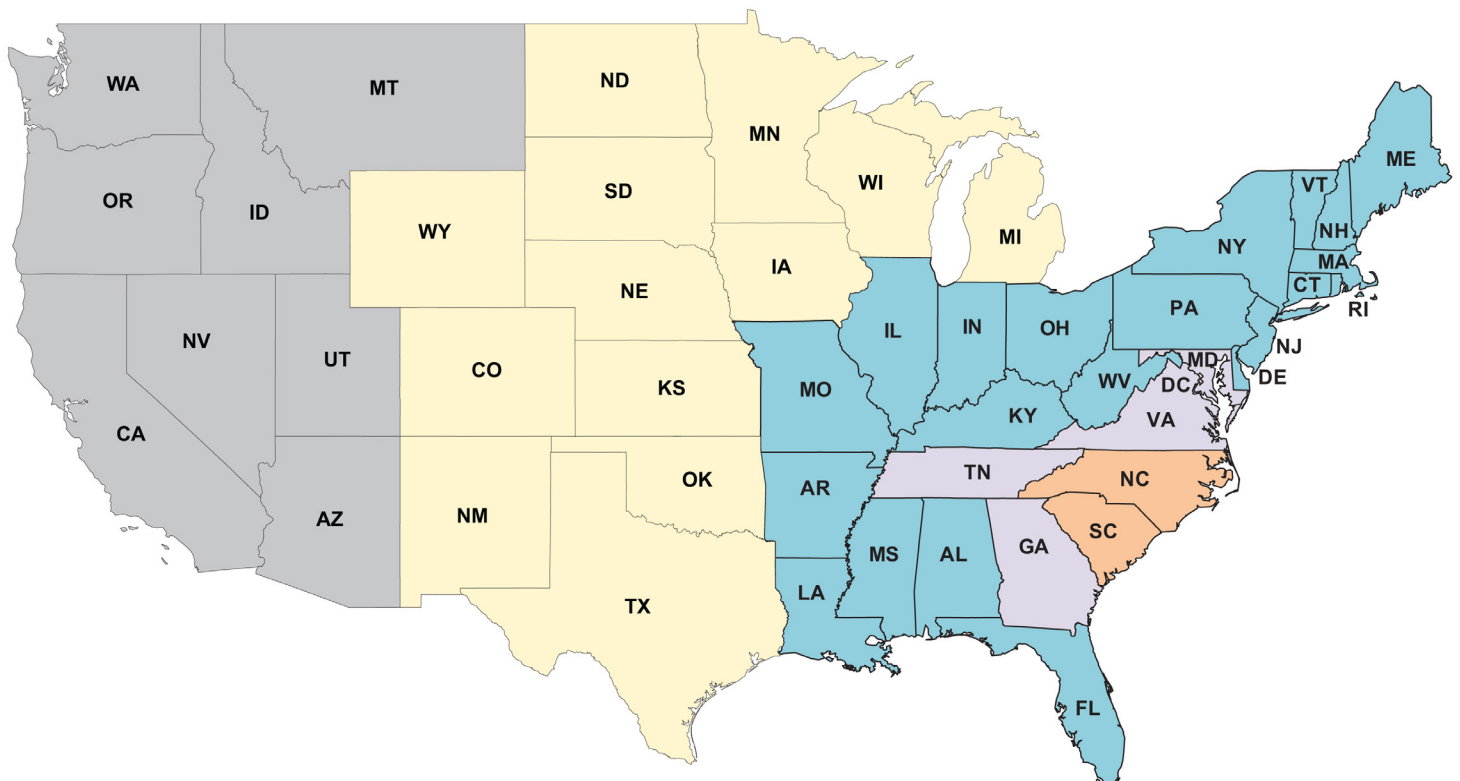

Preferred Carrier Guaranteed Freight Rates - Canada

Freight charges will be applied to orders as a separate line item based on the zones listed. Rates are based on zones with a minimum for each zone.

The freight amount is calculated on the total merchandise list COM price. Additional freight fuel surcharges may apply. Rates are based on deliveries made Monday through Friday, 8 am until 5 pm.

All orders are shipped by Bernhardt Design company trucks or preferred carriers specified by Bernhardt Design. If a purchase order does not specify that the product must ship complete, Bernhardt Design reserves the right to select the most effective shipping method necessary, including split shipments. Dealer warehouse information, including phone number and contact name, must be specified on the purchase order.

Direct site deliveries may be requested with an additional freight cost. Requests for direct site deliveries must be made 2 weeks prior to the scheduled ship week and meet the following criteria:

- Minimum of half truckload
- Delivery site accessible by a 53' trailer
- Complete delivery site address with contact name and on-site phone number
- Labor available for unloading

Deliveries that do not meet the criteria must be directed to a receiver warehouse. If a receiver warehouse is not available, the dealer may make arrangements with their own 3rd party carrier. If a 3rd party carrier is elected, a contact name, phone number and e-mail address is required.

Bernhardt Design has a no touch freight policy. Drivers are not allowed to unload freight.

Weekend direct site deliveries will incur a \$500 per trailer weekend delivery fee. Weekend is defined as between 5 pm Friday and 8 am Monday.

Customers who decline GFP should refer to the shipping section of the Terms and Conditions page.

Zone	Minimums	Freight	Avg. Bus. Days
Zone 1	\$200	5%	10-15
Zone 2	\$200	9%	10-15
Zone 3	\$200	8%	10-15
Zone 4	\$200	11%	10-15
Zone 5	Quote	Quote	

The attached rates are strictly freight and do not include brokerage fees.

