



friends lounge modular seating collection

**Friends Seating System Specification Guide**

**Standard Features**



Friends is an upholstered modular seating system comprised of 35 unique modules which can be used interchangeably to create an unlimited number of configurations. The collection includes freestanding, two-seat, three-seat, corner and connecting modules that are available with and without arms. Arms are available as upholstered, solid oak or solid walnut.

The base is offered in polished aluminum or Bernhardt standard powder coat offerings and has 5/8" diameter non-marring adjustable nylon glides on each leg.

Welt is standard on the seat, back and upholstered arms. All COM/COL fabrics must be preapproved by Bernhardt Design prior to application.

When ordering configurations, please provide the total COM yardage from the same dye lot in a continuous roll(s).

All configurations are connected by pre-installed ganging brackets.

Friends is SCS Indoor Advantage™ Gold certified. See terms and conditions for additional finish and environmental information.

Please visit [BernhardtDesign.com](http://BernhardtDesign.com) for a complete library of 2D, 3D and Revit models. You may also contact your local sales representative or the Bernhardt Design Corporate Office for specification assistance.

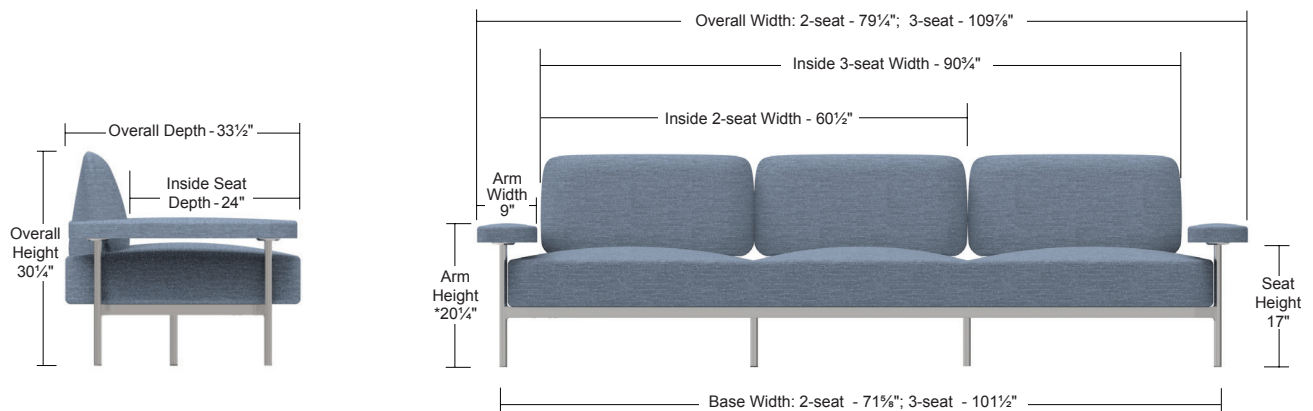

**Side View**  
 Showing SKU 5F7XU  
 Freestanding 3-Seat Sofa

**Front View**  
 Showing SKU 5F7XU  
 Freestanding 3-Seat Sofa  
 \* Arm height shown is for upholstered arm.

Arm Table Options



Oak Table Arm



Walnut Table Arm



Upholstered Table Arm

Solid Wood Selections - Arm Table

When specifying light finishes the natural characteristics of the wood will be visible and color will vary. See terms and conditions for additional finish information.

**C** Solid Oak  
Rift Cut

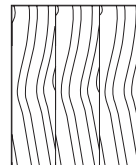

Standard Finish

871 860 870  
837 836 861  
865 805 866  
872 839 845

**9** Solid Walnut  
Flat Cut

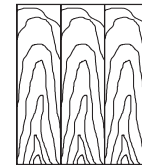

Standard Finish

872 861  
860 823  
839 866  
870 LV8

**OAK** Select Finishes

M73 M72 M75  
M74 M76 M77  
M71

Wood Arm Edge Profile

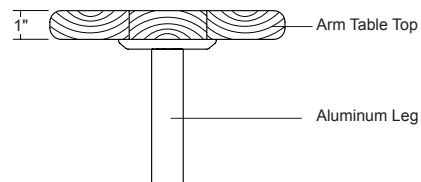

Upholstered Arm Edge Profile

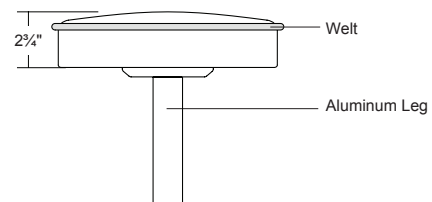

## Base Finish Options



Polished Aluminum Base

## Base Powder Coat Selections

A two character sku identifies each powder coat finish offered. Individual skus are priced with standard metal finish. Non-standard finishes may incur an additional charge.

### Standard Finish



PA Polished Aluminum

### Powder Coat Finishes

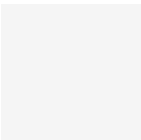

WH Satin White

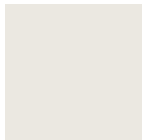

EC Ecu

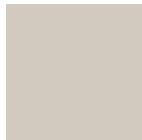

LA Latte



AL Matte Aluminum



GR Graphite



BZ Bronze



SG Sage



IG Iron Grey



RD Black Red



BK Matte Black

### Optional Powder Coat Colors - RAL

- Lead Time - Three weeks additional lead-time after color approval
- Net Up-charge - \$1000 for colors shown in Bernhardt Design RAL Powder Coat Selector
- Minimum Order Quantity - None
- Approval Sample Cost - None
- Combining Products - One up-charge is applicable for multiple products on a single purchase order when they are in the same color

### Custom Powder Coat Colors

- Lead Time - Eight weeks additional lead-time after color approval
- Net Upcharge - \$3000 for solid custom colors
- Net Upcharge - To be quoted upon request for metallic custom colors
- Minimum Order Quantity - None
- Approval Sample Cost - None
- Combining Products - One up-charge is applicable for multiple products on a single purchase order when they are in the same color

**Note:** Metal finish colors may vary between separately ordered skus

### Friends Seating System Product Overview

The Friends product overview below shows examples of the different modules that are available within the lounge modular collection. Freestanding and connecting options are available with and without arms. **The freestanding option is not available for connecting modules.**

**End connecting modules can be ganged on the straight end of the module. Both end connecting modules and corner seats can be ganged on both ends.**

### Freestanding Options



**Three-seat Freestanding**  
Available with upholstered or wood arms



**Two-seat Freestanding**  
Available with upholstered or wood arms



**Three-seat Freestanding**  
Armless



**Two-seat Freestanding**  
Armless

### Connecting Options



**End Connecting Module**  
(Shown) Three-seat Module, RSF  
Available with upholstered or wood arms.  
*Connects on left end*



**End Connecting Module**  
(Shown) Two-seat Module, RSF  
Available with upholstered or wood arms.  
*Connects on left end*



**End Connecting Module**  
(Shown) Three-seat Module, RSF Armless  
*Connects on left end*



**End Connecting Module**  
(Shown) Two-seat Module, RSF Armless  
*Connects on left end*



**Both Ends Connecting Module**  
(Shown) Three-seat Armless Module  
*Connects on both ends*



**Both Ends Connecting Module**  
(Shown) Two-seat Armless Module  
*Connects on both ends*



**Corner Seat**  
*Connects on both ends*

### Arm Options



**Upholstered Arm**



**Solid Oak Arm**



**Solid Walnut Arm**



**None**

**Friends Seating System Specification Guide**

Sku Description

1

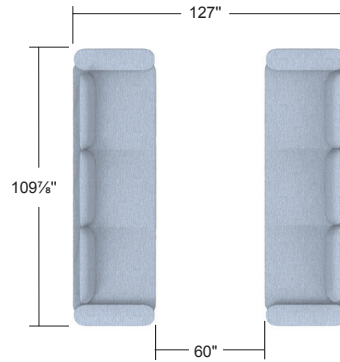

**5F7XU** Three-seat Freestanding Upholstered Arm

2

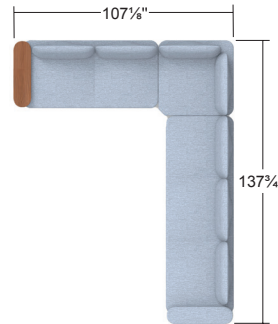

**5D5LW** Two-seat Module  
Left Side Facing  
Solid Walnut Arm

**5C5XX** Corner Seat

**5D7RU** Three-seat Module  
Right Side Facing  
Upholstered Arm

3

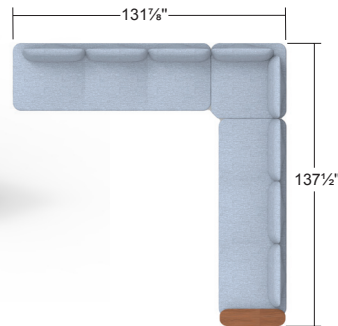

**5D7LX** Three-seat Armless Module  
Left Side Facing

**5C5XX** Corner Seat

**5D7RW** Three-seat Module  
Right Side Facing  
Solid Walnut Arm

**Friends Seating System Specification Guide**

4

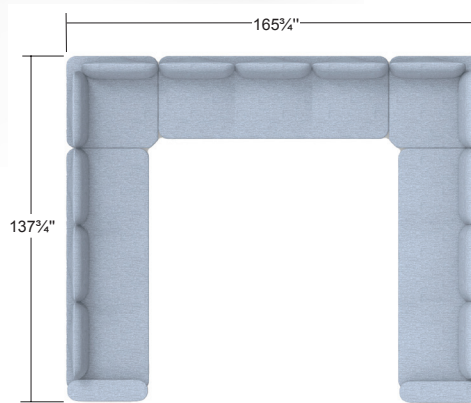

**Sku**    **Description**

- 5D7LU** Three-seat Module  
Left Side Facing  
Upholstered Arm
- 5C5XX** Corner Seat
- 5B7XX** Three-seat Armless Module
- 5C5XX** Corner Seat
- 5D7RU** Three-seat Module  
Right Side Facing  
Upholstered Arm

5

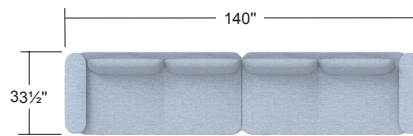

- 5D5LU** Two-seat Module  
Left Side Facing  
Upholstered Arm
- 5D5RU** Two-seat Module  
Right Side Facing  
Upholstered Arm



**Friends 5F5XC**

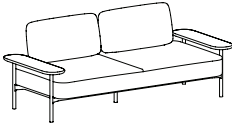

**Two-seat freestanding**  
**Solid oak arms**  
**Polished aluminum or powder coat base**  
**Upholstered seat and back**

Standard with welt  
Inside seat width: 63¼", Inside seat depth: 24"

Table arm available in all oak finishes. When specifying light finish the natural characteristics of the wood will be visible and color will vary.

When using a combination of fabrics or leathers, specify the application by designating the appropriate letter, shown below, on the purchase order. Yardage shown must be used.

- A) One fabric or leather for seat  
yardage: 5.0 yds. leather: 81.0 sq. ft.
- B) One fabric or leather for inside back and outside back  
yardage: 3.0 yds. leather: 49.0 sq. ft
- D) One fabric or leather for welt  
yardage: 1.0 yds. leather: 16.2 sq. ft.

See terms and conditions for contrasting upholstery upcharges.

SCS Indoor Advantage™ Gold certified. See terms and conditions for additional environmental information.

Seat Height	Arm Height	W	D	H	Fabric	Leather	Weight	Cubes/Qty
17"	18½"	73¼"	33½"	30¼"	8.0 yds.	130.0'	235 lbs	74.31'/1
432 mm	470 mm	1861 mm	851 mm	768 mm	7.3 m	12.1 sqm	106.6 kg	2.1 cu.

COM	COL	1	2	3	4	5	6	7	8	9	10	11
4892	5052	5692	5852	5941	6066	6208	6279	6404	6510	6635	6812	7435

**sku**

**5F5XC**

5 | F | 5 | X | C

**base finish**

**PA** polished aluminum standard, OR  
*specify powder coat, upcharge \$250*

**WH** satin white      **GR** graphite      **SG** sage  
**EC** ecru              **BZ** bronze        **RD** black red  
**LA** latte              **IG** iron grey      **BK** matte black  
**AL** matte aluminum

**arm finish**

see seating finishes - oak

**Friends 5F5XW**

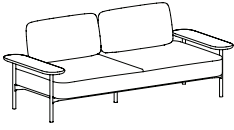

**Two-seat freestanding**  
**Solid walnut arms**  
**Polished aluminum or powder coat base**  
**Upholstered seat and back**

Standard with welt  
Inside seat width: 63¼", Inside seat depth: 24"

Table arm available in all walnut finishes. When specifying light finish the natural characteristics of the wood will be visible and color will vary.

When using a combination of fabrics or leathers, specify the application by designating the appropriate letter, shown below, on the purchase order. Yardage shown must be used.

- A) One fabric or leather for seat  
yardage: 5.0 yds. leather: 81.0 sq. ft.
- B) One fabric or leather for inside back and outside back  
yardage: 3.0 yds. leather: 49.0 sq. ft.
- D) One fabric or leather for welt  
yardage: 1.0 yds. leather: 16.2 sq. ft.

See terms and conditions for contrasting upholstery upcharges.

SCS Indoor Advantage™ Gold certified. See terms and conditions for additional environmental information.

Seat Height	Arm Height	W	D	H	Fabric	Leather	Weight	Cubes/Qty
17"	18 ½"	73¼"	33½"	30¼"	8.0 yds.	130.0'	235 lbs	74.31'/1
432 mm	470 mm	1861 mm	851 mm	768 mm	7.3 m	12.1 sqm	106.6 kg	2.1 cu.

COM	COL	1	2	3	4	5	6	7	8	9	10	11
4892	5052	5692	5852	5941	6066	6208	6279	6404	6510	6635	6812	7435

**sku**

**5F5XW**

5 | F | 5 | X | W

**base finish**

**PA** polished aluminum standard, OR  
*specify powder coat, upcharge \$250*

**WH** satin white      **GR** graphite      **SG** sage  
**EC** ecru              **BZ** bronze         **RD** black red  
**LA** latte              **IG** iron grey      **BK** matte black  
**AL** matte aluminum

**arm finish**

see seating  
finishes - walnut

**Friends 5F5XX**

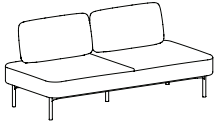

**Two-seat freestanding armless  
Polished aluminum or powder coat base  
Upholstered seat and back**

Standard with welt

Inside seat depth: 24"

When using a combination of fabrics or leathers, specify the application by designating the appropriate letter, shown below, on the purchase order. Yardage shown must be used.

- A) One fabric or leather for seat  
yardage: 5.0 yds. leather: 81.0 sq. ft.
- B) One fabric or leather for inside back and outside back  
yardage: 3.0 yds. leather: 49.0 sq. ft.
- D) One fabric or leather for welt  
yardage: 1.0 yds. leather: 16.2 sq. ft.

See terms and conditions for contrasting upholstery upcharges.

SCS Indoor Advantage™ Gold certified. See terms and conditions for additional environmental information.

Seat Height	Arm Height	W	D	H	Fabric	Leather	Weight	Cubes/Qty
17"	-	68¼"	33½"	30¼"	8.0 yds.	130.0'	209 lbs	69.18'/1
432 mm	-	1734 mm	851 mm	768 mm	7.3 m	12.1 sqm	94.1 kg	1.95 cu.

COM	COL	1	2	3	4	5	6	7	8	9	10	11
4073	4233	4873	5033	5122	5247	5389	5460	5585	5691	5816	5993	6616

**sku**

5F5XX

5 | F | 5 | X | X |

**base finish**

PA polished aluminum standard, OR

specify powder coat, upcharge \$250

- WH satin white
- EC ecru
- LA latte
- AL matte aluminum
- GR graphite
- BZ bronze
- IG iron grey
- SG sage
- RD black red
- BK matte black

**Friends 5F7XU**

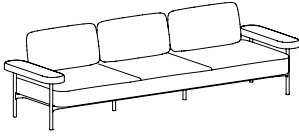

**Three-seat freestanding  
Upolstered arms  
Polished aluminum or powder coat base  
Upholstered seat and back**

Standard with welt

Inside seat width: 90¾", Inside seat depth: 24"

When using a combination of fabrics or leathers, specify the application by designating the appropriate letter, shown below, on the purchase order. Yardage shown must be used.

- A) One fabric or leather for seat  
yardage: 7.0 yds. leather: 113.4 sq. ft.
- B) One fabric or leather for inside back and outside back  
yardage: 4.5 yds. leather: 72.9 sq. ft.
- C) One fabric or leather for arm  
yardage: 2.5 yds. leather: 40.5 sq. ft.
- D) One fabric or leather for welt  
yardage: 1.25 yds. leather: 20.25 sq. ft.

See terms and conditions for contrasting upholstery upcharges.

SCS Indoor Advantage™ Gold certified. See terms and conditions for additional environmental information.

Seat Height	Arm Height	W	D	H	Fabric	Leather	Weight	Cubes/Qty
17"	20¼"	109½"	33½"	30¼"	11.25 yds.	182.25'	302 lbs	98.23'/1
432 mm	514 mm	2791 mm	851 mm	768 mm	10.3 m	17.0 sqm	137.0 kg	2.78 cu.

COM	COL	1	2	3	4	5	6	7	8	9	10	11
5760	5985	6885	7110	7235	7410	7610	7710	7885	8035	8210	8460	9335

**sku**

**5F7XU**

5 | F | 7 | X | U

**base finish**

**PA** polished aluminum standard, OR  
 specify powder coat, upcharge \$250

<b>WH</b> satin white	<b>GR</b> graphite	<b>SG</b> sage
<b>EC</b> ecru	<b>BZ</b> bronze	<b>RD</b> black red
<b>LA</b> latte	<b>IG</b> iron grey	<b>BK</b> matte black
<b>AL</b> matte aluminum		

**Friends 5F7XC**

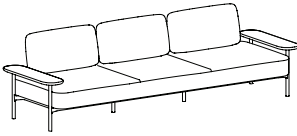

**Three-seat freestanding**  
**Solid oak arms**  
**Polished aluminum or powder coat base**  
**Upholstered seat and back**

Standard with welt

Inside seat width: 91¾", Inside seat depth: 24"

Table arm available in all oak finishes. When specifying light finish the natural characteristics of the wood will be visible and color will vary.

When using a combination of fabrics or leathers, specify the application by designating the appropriate letter, shown below, on the purchase order. Yardage shown must be used.

- A) One fabric or leather for seat  
yardage: 7.0 yds. leather: 113.4 sq. ft.
- B) One fabric or leather for inside back and outside back  
yardage: 4.5 yds. leather: 72.9 sq. ft.
- D) One fabric or leather for welt  
yardage: 1.25 yds. leather: 20.25 sq. ft.

See terms and conditions for contrasting upholstery upcharges.

SCS Indoor Advantage™ Gold certified. See terms and conditions for additional environmental information.

Seat Height	Arm Height	W	D	H	Fabric	Leather	Weight	Cubes/Qty
17"	18 ½"	108 ¾"	33 ½"	30 ¼"	11.25 yds.	182.25'	302 lbs	98.23/1
432 mm	470 mm	2765 mm	851 mm	768 mm	10.3 m	17.0 sqm	137.0 kg	2.78 cu.

COM	COL	1	2	3	4	5	6	7	8	9	10	11
6186	6411	7311	7536	7661	7836	8036	8136	8311	8461	8636	8886	9761

**sku**

5F7XC

5	F	7	X	C
---	---	---	---	---

**base finish**

**PA** polished aluminum standard, OR  
 specify powder coat, upcharge \$250

<b>WH</b> satin white	<b>GR</b> graphite	<b>SG</b> sage
<b>EC</b> ecru	<b>BZ</b> bronze	<b>RD</b> black red
<b>LA</b> latte	<b>IG</b> iron grey	<b>BK</b> matte black
<b>AL</b> matte aluminum		

**arm finish**

see seating finishes - oak

--	--	--

**Friends 5F7XW**

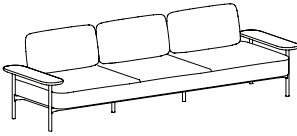

**Three-seat freestanding**  
**Solid walnut arms**  
**Polished aluminum or powder coat base**  
**Upholstered seat and back**

Standard with welt

Inside seat width: 91¾", Inside seat depth: 24"

Table arm available in all walnut finishes. When specifying light finish the natural characteristics of the wood will be visible and color will vary.

When using a combination of fabrics or leathers, specify the application by designating the appropriate letter, shown below, on the purchase order. Yardage shown must be used.

- A) One fabric or leather for seat  
yardage: 7.0 yds. leather: 113.4 sq. ft.
- B) One fabric or leather for inside back and outside back  
yardage: 4.5 yds. leather: 72.9 sq. ft.
- D) One fabric or leather for welt  
yardage: 1.25 yds. leather: 20.25 sq. ft.

See terms and conditions for contrasting upholstery upcharges.

SCS Indoor Advantage™ Gold certified. See terms and conditions for additional environmental information.

Seat Height	Arm Height	W	D	H	Fabric	Leather	Weight	Cubes/Qty
17"	18 ½"	108 ¾"	33 ½"	30 ¼"	11.25 yds.	182.25'	302 lbs	98.23/1
432 mm	470 mm	2765 mm	851 mm	768 mm	10.3 m	17.0 sqm	137.0 kg	2.78 cu.

COM	COL	1	2	3	4	5	6	7	8	9	10	11
6186	6411	7311	7536	7661	7836	8036	8136	8311	8461	8636	8886	9761

**sku**

**5F7XW**

5 | F | 7 | X | W

**base finish**

**PA** polished aluminum standard, OR  
specify powder coat, upcharge \$250

<b>WH</b> satin white	<b>GR</b> graphite	<b>SG</b> sage
<b>EC</b> ecru	<b>BZ</b> bronze	<b>RD</b> black red
<b>LA</b> latte	<b>IG</b> iron grey	<b>BK</b> matte black
<b>AL</b> matte aluminum		

**arm finish**

see seating finishes - walnut

**Friends 5F7XX**

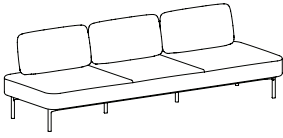

**Three-seat freestanding armless  
Polished aluminum or powder coat base  
Upholstered seat and back**

Standard with welt

Inside seat depth: 24"

When using a combination of fabrics or leathers, specify the application by designating the appropriate letter, shown below, on the purchase order. Yardage shown must be used.

- A) One fabric or leather for seat  
yardage: 7.0 yds. leather: 113.4 sq. ft.
- B) One fabric or leather for inside back and outside back  
yardage: 4.5 yds. leather: 72.9 sq. ft.
- D) One fabric or leather for welt  
yardage: 1.25 yds. leather: 20.25 sq. ft.

See terms and conditions for contrasting upholstery upcharges.

SCS Indoor Advantage™ Gold certified. See terms and conditions for additional environmental information.

Seat Height	Arm Height	W	D	H	Fabric	Leather	Weight	Cubes/Qty
17"	-	98¾"	33½"	30¼"	11.25 yds.	182.25'	287 lbs	93.11'/1
432 mm	-	2511 mm	851 mm	768 mm	10.3 m	17.0 sqm	130.2 kg	2.63 cu.

COM	COL	1	2	3	4	5	6	7	8	9	10	11
5367	5592	6492	6717	6842	7017	7217	7317	7492	7642	7817	8067	8942

**sku**

5F7XX

5 | F | 7 | X | X |

**base finish**

PA polished aluminum standard, OR

specify powder coat, upcharge \$250

- WH satin white
- EC ecru
- LA latte
- AL matte aluminum
- GR graphite
- BZ bronze
- IG iron grey
- SG sage
- RD black red
- BK matte black

**Friends 5D5LU and 5D5RU**

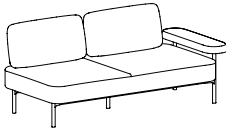
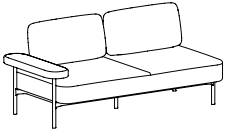

**Two-seat module**  
**Upholstered arm**  
**Polished aluminum or powder coat base**  
**Upholstered seat and back**

**5D5LU** Left side facing  
**5D5RU** Right side facing

Standard with welt  
 All necessary ganging brackets are included and pre-installed  
 Freestanding option not available

Inside seat width: 61½", Inside seat depth: 24"

When using a combination of fabrics or leathers, specify the application by designating the appropriate letter, shown below, on the purchase order. Yardage shown must be used.

- A) One fabric or leather for seat  
 yardage: 5.0 yds.      leather: 81.0 sq. ft.
- B) One fabric or leather for inside back and outside back  
 yardage: 3.0 yds.      leather: 49.0 sq. ft.
- C) One fabric or leather for arm  
 yardage: 2.5 yds.      leather: 40.5 sq. ft.
- D) One fabric or leather for welt  
 yardage: 1.0 yds.      leather: 16.2 sq. ft.

See terms and conditions for contrasting upholstery upcharges.

SCS Indoor Advantage™ Gold certified. See terms and conditions for additional environmental information.

Seat Height	Arm Height	W	D	H	Fabric	Leather	Weight	Cubes/Qty
17"	20 ¼"	70"	33 ½"	30 ¼"	8.0 yds.	130'	203 lbs	66.63'/1
432 mm	514 mm	1778 mm	851 mm	768 mm	7.3 m	12.1 sqm	92.1 kg	1.88 cu.

COM	COL	1	2	3	4	5	6	7	8	9	10	11
4270	4430	5070	5230	5319	5444	5586	5657	5782	5888	6013	6190	6813

**sku**

**5D5LU** left side facing  
**5D5RU** right side facing

--	--	--	--	--

**base finish**

**PA** polished aluminum standard, OR  
 specify powder coat, upcharge \$250  
**WH** satin white      **GR** graphite      **SG** sage  
**EC** ecru              **BZ** bronze          **RD** black red  
**LA** latte              **IG** iron grey        **BK** matte black  
**AL** matte aluminum

--	--

**Friends 5D5LC and 5D5RC**

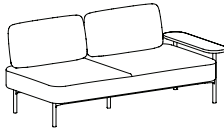
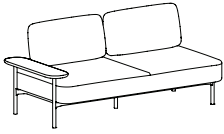

**Two-seat module**  
**Solid oak arm**  
**Polished aluminum or powder coat base**  
**Upholstered seat and back**

**5D5LC** Left side facing  
**5D5RC** Right side facing

Standard with welt  
 All necessary ganging brackets are included and pre-installed  
 Freestanding option not available

Inside seat width: 62", Inside seat depth: 24"

Table arm available in all oak finishes. When specifying light finish the natural characteristics of the wood will be visible and color will vary.

When using a combination of fabrics or leathers, specify the application by designating the appropriate letter, shown below, on the purchase order. Yardage shown must be used.

- A) One fabric or leather for seat  
 yardage: 5.0 yds. leather: 81.0 sq. ft.
- B) One fabric or leather for inside back and outside back  
 yardage: 3.0 yds. leather: 49.0 sq. ft
- D) One fabric or leather for welt  
 yardage: 1.0 yds. leather: 16.2 sq. ft.

See terms and conditions for contrasting upholstery upcharges.

SCS Indoor Advantage™ Gold certified. See terms and conditions for additional environmental information.

Seat Height	Arm Height	W	D	H	Fabric	Leather	Weight	Cubes/Qty
17"	18 1/2"	69 3/4"	33 1/2"	30 1/4"	8.0 yds.	130.0'	203 lbs	66.63'/1
432 mm	470 mm	1772 mm	851 mm	768 mm	7.3 m	12.1 sqm	92.1 kg	1.88 cu.

COM	COL	1	2	3	4	5	6	7	8	9	10	11
4488	4648	5288	5448	5537	5662	5804	5875	6000	6106	6231	6408	7031

**sku**  
**5D5LC** left side facing  
**5D5RC** right side facing

**base finish**  
**PA** polished aluminum standard, OR  
 specify powder coat, upcharge \$250  
**WH** satin white      **GR** graphite      **SG** sage  
**EC** ecru              **BZ** bronze              **RD** black red  
**LA** latte              **IG** iron grey              **BK** matte black  
**AL** matte aluminum

**arm finish**  
 see seating  
 finishes - oak

**Friends 5D5LW and 5D5RW**

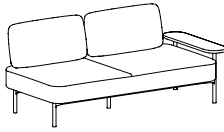
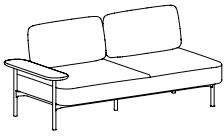

**Two-seat module**  
**Solid walnut arm**  
**Polished aluminum or powder coat base**  
**Upholstered seat and back**

**5D5LW** Left side facing  
**5D5RW** Right side facing

Standard with welt  
All necessary ganging brackets are included and pre-installed  
Freestanding option not available

Inside seat width: 62", Inside seat depth: 24"

Table arm available in all walnut finishes. When specifying light finish the natural characteristics of the wood will be visible and color will vary.

When using a combination of fabrics or leathers, specify the application by designating the appropriate letter, shown below, on the purchase order. Yardage shown must be used.

- A) One fabric or leather for seat  
yardage: 5.0 yds. leather: 81.0 sq. ft.
- B) One fabric or leather for inside back and outside back  
yardage: 3.0 yds. leather: 49.0 sq. ft.
- D) One fabric or leather for welt  
yardage: 1.0 yds. leather: 16.2 sq. ft.

See terms and conditions for contrasting upholstery upcharges.

SCS Indoor Advantage™ Gold certified. See terms and conditions for additional environmental information.

Seat Height	Arm Height	W	D	H	Fabric	Leather	Weight	Cubes/Qty
17"	18 1/2"	69 3/4"	33 1/2"	30 1/4"	8.0 yds.	130.0'	203 lbs	66.63/1
432 mm	470 mm	1772 mm	851 mm	768 mm	7.3 m	12.1 sqm	92.1 kg	1.88 cu.

COM	COL	1	2	3	4	5	6	7	8	9	10	11
4488	4648	5288	5448	5537	5662	5804	5875	6000	6106	6231	6408	7031

**sku**

<b>5D5LW</b>	left side facing
<b>5D5RW</b>	right side facing

**base finish**

<b>PA</b>	polished aluminum standard, OR		
<i>specify powder coat, upcharge \$250</i>			
<b>WH</b>	satin white	<b>GR</b>	graphite
<b>EC</b>	ecru	<b>BZ</b>	bronze
<b>LA</b>	latte	<b>IG</b>	iron grey
<b>AL</b>	matte aluminum		
<b>SG</b>	sage		
<b>RD</b>	black red		
<b>BK</b>	matte black		

**arm finish**

see seating finishes - walnut
-------------------------------

**Friends 5D5LX and 5D5RX**

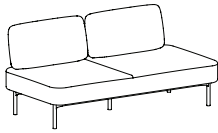
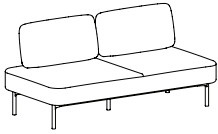

**Two-seater armless module**  
**Polished aluminum or powder coat base**  
**Upholstered seat and back**

**5D5LX** Left side facing  
**5D5RX** Right side facing

Standard with welt  
All necessary ganging brackets are included and pre-installed  
Gangs on straight end of the module  
Freestanding option not available

Inside seat depth: 24"

When using a combination of fabrics or leathers, specify the application by designating the appropriate letter, shown below, on the purchase order. Yardage shown must be used.

- A) One fabric or leather for seat  
yardage: 5.0 yds. leather: 81.0 sq. ft.
- B) One fabric or leather for inside back and outside back  
yardage: 3.0 yds. leather: 49.0 sq. ft.
- D) One fabric or leather for welt  
yardage: 1.0 yds. leather: 16.2 sq. ft.

See terms and conditions for contrasting upholstery upcharges.

SCS Indoor Advantage™ Gold certified. See terms and conditions for additional environmental information.

Seat Height	Arm Height	W	D	H	Fabric	Leather	Weight	Cubes/Qty
17"	-	64½"	33½"	30¼"	8.0 yds.	130.0'	188 lbs	64.92/1
432 mm	-	1629 mm	851 mm	768 mm	7.3 m	12.1 sqm	85.3 kg	1.83 cu.

COM	COL	1	2	3	4	5	6	7	8	9	10	11
4073	4233	4873	5033	5122	5247	5389	5460	5585	5691	5816	5993	6616

**sku**

**5D5LX** left side facing  
**5D5RX** right side facing

--	--	--	--	--

**base finish**

**PA** polished aluminum standard, OR

specify powder coat, upcharge \$250

<b>WH</b> satin white	<b>GR</b> graphite	<b>SG</b> sage
<b>EC</b> ecru	<b>BZ</b> bronze	<b>RD</b> black red
<b>LA</b> latte	<b>IG</b> iron grey	<b>BK</b> matte black
<b>AL</b> matte aluminum		

--	--

**Friends 5B5XX**

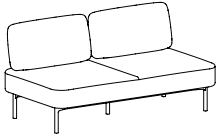

**Two-seat armless module  
Polished aluminum or powder coat base  
Upholstered seat and back**

Standard with welt  
All necessary ganging brackets are included and pre-installed  
Gangs on both ends of the module  
Freestanding option not available

Inside seat depth: 24"

When using a combination of fabrics or leathers, specify the application by designating the appropriate letter, shown below, on the purchase order. Yardage shown must be used.

- A) One fabric or leather for seat  
yardage: 5.0 yds. leather: 81.0 sq. ft.
- B) One fabric or leather for inside back and outside back  
yardage: 3.0 yds. leather: 49.0 sq. ft.
- D) One fabric or leather for welt  
yardage: 1.0 yds. leather: 16.2 sq. ft.

See terms and conditions for contrasting upholstery upcharges.

SCS Indoor Advantage™ Gold certified. See terms and conditions for additional environmental information.

Seat Height	Arm Height	W	D	H	Fabric	Leather	Weight	Cubes/Qty
17"	-	60 3/4"	33 1/2"	30 1/4"	8.0 yds.	130.0'	173 lbs	62.35'/1
432 mm	-	1540 mm	851 mm	768 mm	7.3 m	12.1 sqm	78.5 kg	1.76 cu.

COM	COL	1	2	3	4	5	6	7	8	9	10	11
4073	4233	4873	5033	5122	5247	5389	5460	5585	5691	5816	5993	6616

**sku**

5B5XX

5	B	5	X	X
---	---	---	---	---

**base finish**

PA polished aluminum standard, OR

specify powder coat, upcharge \$250

WH	satin white	GR	graphite	SG	sage
EC	ecru	BZ	bronze	RD	black red
LA	latte	IG	iron grey	BK	matte black
AL	matte aluminum				

**Friends 5D7LU and 5D7RU**

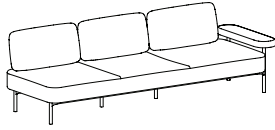
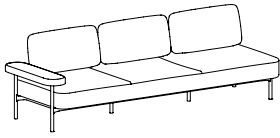

**Three-seat module**  
**Upholstered arm**  
**Polished aluminum or powder coat base**  
**Upholstered seat and back**

**5D7LU** Left side facing  
**5D7RU** Right side facing

Standard with welt  
 All necessary ganging brackets are included and pre-installed  
 Gangs on straight end of the module  
 Freestanding option not available

Inside seat width: 90", Inside seat depth: 24"

When using a combination of fabrics or leathers, specify the application by designating the appropriate letter, shown below, on the purchase order. Yardage shown must be used.

- A) One fabric or leather for seat  
 yardage: 7.0 yds. leather: 113.4 sq. ft.
- B) One fabric or leather for inside back and outside back  
 yardage: 4.5 yds. leather: 72.9 sq. ft.
- C) One fabric or leather for arm  
 yardage: 2.5 yds. leather: 40.5 sq. ft.
- D) One fabric or leather for welt  
 yardage: 1.25 yds. leather: 20.25 sq. ft.

See terms and conditions for contrasting upholstery upcharges.

SCS Indoor Advantage™ Gold certified. See terms and conditions for additional environmental information.

Seat Height	Arm Height	W	D	H	Fabric	Leather	Weight	Cubes/Qty
17"	20 1/4"	100 3/8"	33 1/2"	30 1/4"	11.25 yds.	182.25'	272 lbs	93.11'/1
432 mm	514 mm	2550 mm	851 mm	768 mm	10.3 m	17.0 sqm	123.4 kg	2.63 cu.

COM	COL	1	2	3	4	5	6	7	8	9	10	11
5564	5789	6689	6914	7039	7214	7414	7514	7689	7839	8014	8264	9139

**sku**

**5D7LU** left side facing  
**5D7RU** right side facing

**base finish**

**PA** polished aluminum standard, OR  
 specify powder coat, upcharge \$250

**WH** satin white      **GR** graphite      **SG** sage  
**EC** ecru              **BZ** bronze          **RD** black red  
**LA** latte              **IG** iron grey      **BK** matte black  
**AL** matte aluminum

--	--	--	--	--

--	--

**Friends 5D7LC and 5D7RC**

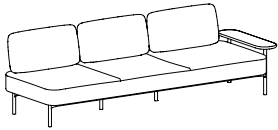
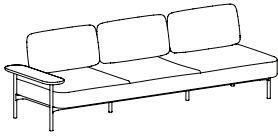

**Three-seat module**  
**Solid oak arm**  
**Polished aluminum or powder coat base**  
**Upholstered seat and back**

**5D7LC** Left side facing  
**5D7RC** Right side facing

Standard with welt  
 All necessary ganging brackets are included and pre-installed  
 Gangs on straight end of the module  
 Freestanding option not available

Inside seat width: 90½", Inside seat depth: 24"

Table arm available in all oak finishes. When specifying light finish the natural characteristics of the wood will be visible and color will vary.

When using a combination of fabrics or leathers, specify the application by designating the appropriate letter, shown below, on the purchase order. Yardage shown must be used.

- A) One fabric or leather for seat  
 yardage: 7.0 yds. leather: 113.4 sq. ft.
- B) One fabric or leather for inside back and outside back  
 yardage: 4.5 yds. leather: 72.9 sq. ft.
- D) One fabric or leather for welt  
 yardage: 1.25 yds. leather: 20.25 sq. ft.

See terms and conditions for contrasting upholstery upcharges.

SCS Indoor Advantage™ Gold certified. See terms and conditions for additional environmental information.

Seat Height	Arm Height	W	D	H	Fabric	Leather	Weight	Cubes/Qty
17"	18 ½"	100¼"	33½"	30¼"	11.25 yds.	182.25'	272 lbs	93.11/1
432 mm	470 mm	2543 mm	851 mm	768 mm	10.3 m	17.0 sqm	123.4 kg	2.63 cu.

COM	COL	1	2	3	4	5	6	7	8	9	10	11
5787	6012	6912	7137	7262	7437	7637	7737	7912	8062	8237	8487	9362

**sku**

**5D7LC** left side facing  
**5D7RC** right side facing

--	--	--	--	--

**base finish**

**PA** polished aluminum standard, OR  
 specify powder coat, upcharge \$250  
**WH** satin white      **GR** graphite      **SG** sage  
**EC** ecru              **BZ** bronze          **RD** black red  
**LA** latte              **IG** iron grey       **BK** matte black  
**AL** matte aluminum

--	--

**arm finish**

see seating  
 finishes - oak

--	--	--

**Friends 5D7LW and 5D7RW**

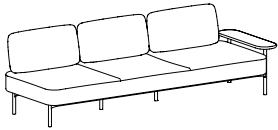
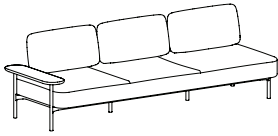

**Three-seat module**  
**Solid walnut arm**  
**Polished aluminum or powder coat base**  
**Upholstered seat and back**

**5D7LW** Left side facing  
**5D7RW** Right side facing

Standard with welt  
 All necessary ganging brackets are included and pre-installed  
 Gangs on straight end of the module  
 Freestanding option not available

Inside seat width: 90½", Inside seat depth: 24"

Table arm available in all walnut finishes. When specifying light finish the natural characteristics of the wood will be visible and color will vary.

When using a combination of fabrics or leathers, specify the application by designating the appropriate letter, shown below, on the purchase order. Yardage shown must be used.

- A) One fabric or leather for seat  
 yardage: 7.0 yds. leather: 113.4 sq. ft.
- B) One fabric or leather for inside back and outside back  
 yardage: 4.5 yds. leather: 72.9 sq. ft.
- D) One fabric or leather for welt  
 yardage: 1.25 yds. leather: 20.25 sq. ft.

See terms and conditions for contrasting upholstery upcharges.

SCS Indoor Advantage™ Gold certified. See terms and conditions for additional environmental information.

Seat Height	Arm Height	W	D	H	Fabric	Leather	Weight	Cubes/Qty
17"	18 ½"	100¼"	33½"	30¼"	11.25 yds.	182.25'	272 lbs	93.11/1
432 mm	470 mm	2543 mm	851 mm	768 mm	10.3 m	17.0 sqm	123.4 kg	2.63 cu.

COM	COL	1	2	3	4	5	6	7	8	9	10	11
5787	6012	6912	7137	7262	7437	7637	7737	7912	8062	8237	8487	9362

**sku**

**5D7LW** left side facing  
**5D7RW** right side facing

--	--	--	--	--

**base finish**

**PA** polished aluminum standard, OR  
 specify powder coat, upcharge \$250  
**WH** satin white      **GR** graphite      **SG** sage  
**EC** ecru              **BZ** bronze          **RD** black red  
**LA** latte              **IG** iron grey       **BK** matte black  
**AL** matte aluminum

--	--

**arm finish**

see seating  
 finishes - walnut

--	--	--

**Friends 5D7LX and 5D7RX**

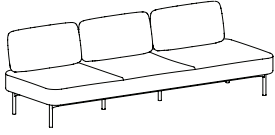
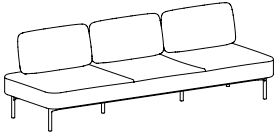

**Three-seat armless module**  
**Polished aluminum or powder coat base**  
**Upholstered seat and back**

**5D7LX** Left side facing  
**5D7RX** Right side facing

Standard with welt  
All necessary ganging brackets are included and pre-installed  
Gangs on straight end of the module  
Freestanding option not available

Inside seat depth: 24"

When using a combination of fabrics or leathers, specify the application by designating the appropriate letter, shown below, on the purchase order. Yardage shown must be used.

- A) One fabric or leather for seat  
yardage: 7.0 yds. leather: 113.4 sq. ft.
- B) One fabric or leather for inside back and outside back  
yardage: 4.5 yds. leather: 72.9 sq. ft.
- D) One fabric or leather for welt  
yardage: 1.25 yds. leather: 20.25 sq. ft.

See terms and conditions for contrasting upholstery upcharges.

SCS Indoor Advantage™ Gold certified. See terms and conditions for additional environmental information.

Seat Height	Arm Height	W	D	H	Fabric	Leather	Weight	Cubes/Qty
17"	-	94½"	33½"	30¼"	11.25 yds.	182.25'	262 lbs	90.54'/1
432 mm	-	2400 mm	851 mm	768 mm	10.3 m	17.0 sqm	118.8 kg	2.56 cu.

COM	COL	1	2	3	4	5	6	7	8	9	10	11
5367	5592	6492	6717	6842	7017	7217	7317	7492	7642	7817	8067	8942

**sku**

**5D7LX** left side facing  
**5D7RX** right side facing

--	--	--	--	--

**base finish**

**PA** polished aluminum standard, OR

*specify powder coat, upcharge \$250*

<b>WH</b> satin white	<b>GR</b> graphite	<b>SG</b> sage
<b>EC</b> ecru	<b>BZ</b> bronze	<b>RD</b> black red
<b>LA</b> latte	<b>IG</b> iron grey	<b>BK</b> matte black
<b>AL</b> matte aluminum		

--	--

**Friends 5B7XX**

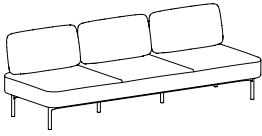

**Three-seat armless module  
Polished aluminum or powder coat base  
Upholstered seat and back**

Standard with welt  
All necessary ganging brackets are included and pre-installed  
Gangs on both ends of the module  
Freestanding option not available

Inside seat depth: 24"

When using a combination of fabrics or leathers, specify the application by designating the appropriate letter, shown below, on the purchase order. Yardage shown must be used.

- A) One fabric or leather for seat  
yardage: 7.0 yds. leather: 113.4 sq. ft.
- B) One fabric or leather for inside back and outside back  
yardage: 4.5 yds. leather: 72.9 sq. ft.
- D) One fabric or leather for welt  
yardage: 1.25 yds. leather: 20.25 sq. ft.

See terms and conditions for contrasting upholstery upcharges.

SCS Indoor Advantage™ Gold certified. See terms and conditions for additional environmental information.

Seat Height	Arm Height	W	D	H	Fabric	Leather	Weight	Cubes/Qty
17"	-	91"	33½"	30¼"	11.25 yds.	182.25'	242 lbs	87.98/1
432 mm	-	2311 mm	851 mm	768 mm	10.3 m	17.0 sqm	109.8 kg	2.49 cu.

COM	COL	1	2	3	4	5	6	7	8	9	10	11
5367	5592	6492	6717	6842	7017	7217	7317	7492	7642	7817	8067	8942

**sku**

5B7XX

5	B	7	X	X
---	---	---	---	---

**base finish**

PA polished aluminum standard, OR

specify powder coat, upcharge \$250

WH	satin white	GR	graphite	SG	sage
EC	ecru	BZ	bronze	RD	black red
LA	latte	IG	iron grey	BK	matte black
AL	matte aluminum				

**Friends 5C5XX**

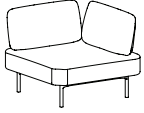

**Corner seat  
Polished aluminum or powder coat base  
Upholstered seat and back**

Standard with welt  
All necessary ganging brackets are included and pre-installed  
Gangs on both ends of the module  
Freestanding option not available

Inside seat depth: 24"

When using a combination of fabrics or leathers, specify the application by designating the appropriate letter, shown below, on the purchase order. Yardage shown must be used.

- A) One fabric or leather for seat  
yardage: 3.0 yds. leather: 49.0 sq. ft.
- B) One fabric or leather for inside back and outside back  
yardage: 3.0 yds. leather: 49.0 sq. ft.
- D) One fabric or leather for welt  
yardage: 1.0 yds. leather: 16.2 sq. ft.

See terms and conditions for contrasting upholstery upcharges.

SCS Indoor Advantage™ Gold certified. See terms and conditions for additional environmental information.

Seat Height	Arm Height	W	D	H	Fabric	Leather	Weight	Cubes/Qty
17"	-	37½"	37½"	30¼"	5.25 yds.	85.0'	135 lbs	35.02/1
432 mm	-	950 mm	851 mm	768 mm	4.8 m	7.9 sqm	61.2 kg	.99 cu.

COM	COL	1	2	3	4	5	6	7	8	9	10	11
3249	3354	3774	3879	3938	4019	4113	4159	4241	4311	4393	4509	4918

**sku**

5C5XX  
  
  
  
  
  
  
  
  
  
  
5 | C | 5 | X | X |

**base finish**

**PA** polished aluminum standard, OR  
  
specify powder coat, upcharge \$250  
**WH** satin white      **GR** graphite      **SG** sage  
**EC** ecru              **BZ** bronze              **RD** black red  
**LA** latte              **IG** iron grey              **BK** matte black  
**AL** matte aluminum