

Luca Benches

Standard Features



The Luca bench collection offers a series of round and rectangular benches that can be used as freestanding or interchangeably with product from the Luca modular seating system. Select benches feature end tables that are available in oak or walnut and are offered with and without power. Legs are available in one of three finishes: polished aluminum, matte black powder coat and satin white powder coat.

Luca benches are part of the Luca modular seating system that is comprised of 41 unique modules. Options include freestanding benches, two-seat and three-seat modules, corner modules and seating and bench modules with end tables.

Luca is fully upholstered with 5/8" diameter non-marring adjustable nylon glides. When ordering configurations, please provide the total COM yardage from the same dye lot in a continuous roll(s). All COM/COL fabrics must be preapproved by Bernhardt Design prior to application. SCS Indoor Advantage™ Gold and LEVEL® 2 certified.

Configurations are connected by a ganging bracket. Ganging brackets are sold separately and will ship with product. See the Luca bench accessories page for ordering information.

Please visit BernhardtDesign.com for a complete library of 2D, 3D and Revit models. You may also contact your local sales representative or the Bernhardt Design corporate office for specification assistance.

Leg Options

Polished Aluminum - 6

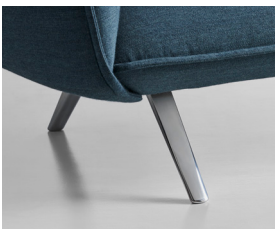

Matte Black Powder Coat- 3



Satin White Powder Coat- W



Luca Bench Options



Veneer Selections

OAK Oak
Order Code - C
Rift Cut

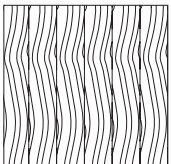

WLT Walnut
Order Code - 9
Flat Cut

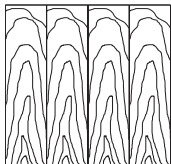

A three-character sku identifies each wood veneer option as well as standard finishes. Base and top finishes are specified separately. When specifying light finishes the natural characteristics of the wood will be visible and color will vary. Therefore, exact color matches are not possible.

OAK Oak

Standard Finish
871 860 870
837 836 861
865 805 866
872 839 845

WLT Walnut

Standard Finish
872 861
860 823
839 866
870

Standard Finish
M73 M71 M75
M74 M76 M77

Edge Profile

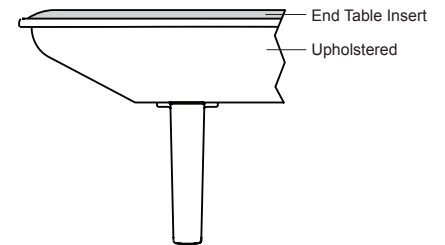

Surface Mount Power Modules

Luca offers a proprietary surface mount power solution which is installed flush to the worksurface and provides (2) 15 amp receptacles, (1) 2 amp USB-A port and (1) 2 amp USB-C port. The unit has a 10' infeed with a grounded plug. Power module finish is determined by leg finish selection.



Power Module
Power Module Finish
Black, Silver or White

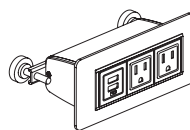

(2) 120 v 60 Hz. 15 amp receptacles
(1) 2 amp USB-A port, 10 watt
(1) 2 amp USB-C port, 20 watt

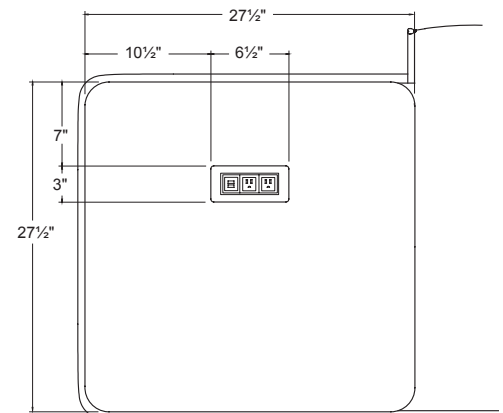

Connecting Modules



Luca modules connect by attaching a ganging bracket to the underside of the furniture. Order one ganging bracket per point of connection of modular units. Ganging brackets are sold separately and will ship with product.

To connect the modules together insert the three fasteners into the inserts at the location each module is desired to be connected. Push modules together in desired location.

Leave 1/4" between head of fastener and upholstery. Fit bracket over heads of fasteners and slide bracket to lock fasteners into keyhole slots cut into fastener. Tighten fasteners against bracket.

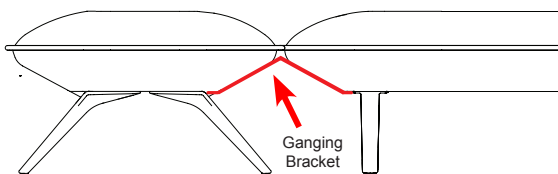

Ganging bracket is concealed behind flange and is not visible when looking at the sofa.

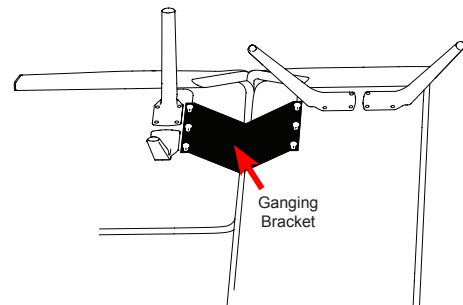

Under side view of the ganging bracket placement

luca 8D36D



36" Round bench
Freestanding
Polished aluminum or powder coat legs
Upholstered

SCS Indoor Advantage™ Gold and LEVEL® 2 certified. See terms and conditions for instructions for additional environmental information.

Seat Height	Arm Height	W	D	H	Fabric	Leather	Weight	Cubes/Qty
16½"	-	36"	36"	16½"	3.0 yds.	49.0'	68 lbs.	19.4'/1
419 mm	-	914 mm	914 mm	419 mm	2.7 m	4.6 sqm	30.8 kg	0.55 cu.

COM	COL	1	2	3	4	5	6	7	8	9	10	11
1947	2007	2227	2274	2301	2354	2401	2421	2454	2501	2541	2587	2854

luca 8D42D



42" Round bench
Freestanding
Polished aluminum or powder coat legs
Upholstered

SCS Indoor Advantage™ Gold and LEVEL® 2 certified. See terms and conditions for instructions for additional environmental information.

Seat Height	Arm Height	W	D	H	Fabric	Leather	Weight	Cubes/Qty
16½"	-	42"	42"	16½"	3.5 yds.	57.0'	90 lbs.	25.72'/1
419 mm	-	1067 mm	1067 mm	419 mm	3.2 m	5.3 sqm	40.8 kg	.72 cu.

COM	COL	1	2	3	4	5	6	7	8	9	10	11
2225	2295	2552	2607	2638	2700	2754	2778	2817	2871	2918	2972	3283

sku

--	--	--	--	--	--	--	--	--	--	--	--	--	--

frame finish

- 6** polished aluminum standard, OR
- specify powder coat, upcharge \$150
- 3** matte black powder coat
- W** satin white powder coat

--

luca 8D48D

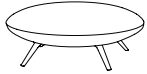

48" Round bench
Freestanding
Polished aluminum or powder coat legs
Upholstered

SCS Indoor Advantage™ Gold and LEVEL® 2 certified. See terms and conditions for additional environmental information.

Seat Height	Arm Height	W	D	H	Fabric	Leather	Weight	Cubes/Qty
16½"	-	48"	48"	16½"	5.75 yds.	95.0'	109 lbs.	32.86'/1
419 mm	-	1219 mm	1219mm	419 mm	5.3 m	8.2 sqm	49.4 kg	.93 cu.

COM	COL	1	2	3	4	5	6	7	8	9	10	11
2505	2620	3042	3132	3183	3285	3374	3413	3477	3566	3643	3732	4243

luca 8D60D



60" Round bench
Freestanding
Polished aluminum powder coat legs
Upholstered

SCS Indoor Advantage™ Gold and LEVEL® 2 certified. See terms and conditions for additional environmental information.

Seat Height	Arm Height	W	D	H	Fabric	Leather	Weight	Cubes/Qty
16 ½"	-	60"	60"	16½"	6.3 yds.	103.0'	148 lbs.	49.78'/1
419 mm	-	1524 mm	1524 mm	419 mm	5.8 m	9.6 sqm	67.1 kg	1.40 cu.

COM	COL	1	2	3	4	5	6	7	8	9	10	11
3061	3187	3649	3747	3803	3915	4013	4055	4125	4223	4307	4405	4965

sku

--	--	--	--	--	--	--	--	--	--	--	--	--

frame finish

- 6** polished aluminum standard, OR
- specify powder coat, upcharge \$150*
- 3** matte black powder coat
- W** satin white powder coat

luca 8D07N

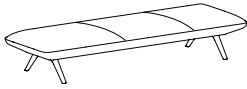

Three-seat module bench
Polished aluminum or powder coat legs
Upholstered

Ganging brackets are sold separately and will ship with the product. See Luca accessories page to order brackets.

SCS Indoor Advantage™ Gold and LEVEL® 2 certified. See terms and conditions for additional environmental information.

Seat Height	Arm Height	W	D	H	Fabric	Leather	Weight	Cubes/Qty
16½"	-	87¼"	28¾"	16½"	7.25 yds.	118.0'	121 lbs	37.6'/1
419 mm	-	2216 mm	730 mm	419 mm	6.6 m	11.0 sqm	54.9 kg	1.10 cu.

COM	COL	1	2	3	4	5	6	7	8	9	10	11
2642	2787	3319	3432	3496	3625	3738	3786	3867	3980	4076	4189	4834

luca 8D02N

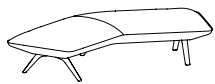

45° Modular bench
Polished aluminum or powder coat legs
Upholstered

Ganging brackets are sold separately and will ship with the product. See Luca accessories page to order brackets.

SCS Indoor Advantage™ Gold and LEVEL® 2 certified. See terms and conditions for additional environmental information.

Seat Height	Arm Height	W	D	H	Fabric	Leather	Weight	Cubes/Qty
16½"	-	80½"	40¼"	16½"	4.75 yds.	78.0'	119 lbs.	45.45'/1
419 mm	-	2045 mm	1022 mm	419 mm	4.3 m	7.2 sqm	54.0 kg	1.30 cu.

COM	COL	1	2	3	4	5	6	7	8	9	10	11
2642	2737	3086	3160	3202	3286	3360	3392	3445	3519	3582	3656	4078

sku

--	--	--	--	--	--	--	--	--	--	--	--	--

frame finish

- 6** polished aluminum standard, OR
- specify powder coat, upcharge \$150
- 3** matte black powder coat
- W** satin white powder coat

--

luca 8D09N

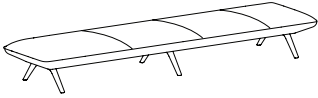

Four-seat module bench
Polished aluminum or powder coat legs
Upholstered

Ganging brackets are sold separately and will ship with product. See Luca accessories page to order brackets

SCS Indoor Advantage™ Gold and LEVEL® 2 certified. See terms and conditions for additional environmental information.

Seat Height	Arm Height	W	D	H	Fabric	Leather	Weight	Cubes/Qty
16½"	-	117"	28¾"	16½"	9.5 yds.	154.0'	159 lbs.	50.0'/1
419 mm	-	2972 mm	730 mm	419 mm	8.7 m	14.3 sqm	72.1 kg	1.40 cu.

COM	COL	1	2	3	4	5	6	7	8	9	10	11
3338	3528	4225	4373	4457	4626	4774	4837	4943	5091	5217	5365	6210

sku

--	--	--	--	--	--

frame finish

- 6** polished aluminum standard, OR
- specify powder coat, upcharge \$200
- 3** matte black powder coat
- W** satin white powder coat

--

luca 8D06N

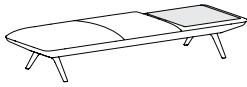

Two-seat bench with end table
Polished aluminum or powder coat legs
Upholstered

End table available in all oak and walnut finishes. When specifying light finish the natural characteristics of the wood will be visible and color will vary.

Ganging brackets are sold separately and will ship with the product. See Luca accessories page to order brackets.

SCS Indoor Advantage™ Gold and LEVEL® 2 certified. See terms and conditions for additional finish and environmental information.

Seat Height	Arm Height	W	D	H	Fabric	Leather	Weight	Cubes/Qty
16½"	-	86¼"	28¾"	16½"	6.75 yds.	110.0'	140 lbs.	37.6'/1
419 mm	-	2191 mm	730 mm	419 mm	6.2 m	10.2 sqm	63.5 kg	1.10 cu.

COM	COL	1	2	3	4	5	6	7	8	9	10	11
3198	3333	3828	3933	3993	4113	4218	4263	4338	4443	4533	4638	5238

luca 8P06N

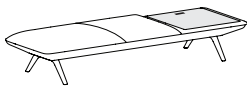

Power
Two-seat bench with end table
Polished aluminum or powder coat legs
Upholstered

End table available in all oak and walnut finishes. When specifying light finish the natural characteristics of the wood will be visible and color will vary.

Ganging brackets are sold separately and will ship with the product. See Luca accessories page to order brackets.

Power: Surface mount power provides (2) 15 amp receptacles, (1) 2 amp USB-A port, 10 watt and (1) 2 amp USB-C port, 20 watt.

SCS Indoor Advantage™ Gold and LEVEL® 2 certified. See terms and conditions for additional finish and environmental information.

Seat Height	Arm Height	W	D	H	Fabric	Leather	Weight	Cubes/Qty
16½"	-	86¼"	28¾"	16½"	6.75 yds.	110.0'	143 lbs.	37.6'/1
419 mm	-	2191 mm	730 mm	419 mm	6.2 m	10.2 sqm	64.9 kg	1.10 cu.

COM	COL	1	2	3	4	5	6	7	8	9	10	11
3963	4098	4593	4698	4758	4878	4983	5028	5103	5208	5298	5403	6003

sku	frame finish	run-off top species	wood top finish
	6 polished aluminum standard, OR specify powder coat, upcharge \$150 3 matte black powder coat W satin white powder coat	C oak 9 walnut	see seating finishes

luca 8D08N

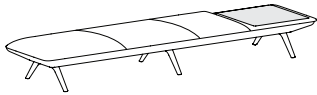

Three-seat bench with end table
Polished aluminum or powder coat legs
Upholstered

End table available in all oak and walnut finishes. When specifying light finish the natural characteristics of the wood will be visible and color will vary.

Ganging brackets are sold separately and will ship with the product. See Luca accessories page to order brackets.

SCS Indoor Advantage™ Gold and LEVEL® 2 certified. See terms and conditions for additional finish and environmental information.

Seat Height	Arm Height	W	D	H	Fabric	Leather	Weight	Cubes/Qty
16½"	-	115¼"	28¾"	16½"	8.5 yds.	140.0'	178 lbs.	50.0'/1
419 mm	-	2921 mm	730 mm	419 mm	7.8 m	13.0 sqm	80.7 kg	1.40 cu.

COM	COL	1	2	3	4	5	6	7	8	9	10	11
3755	3925	4549	4681	4757	4908	5040	5097	5191	5323	5437	5569	6324

luca 8P08N

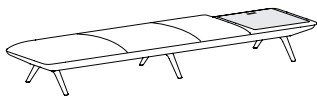

Power
Three-seat bench with end table
Polished aluminum or powder coat legs
Upholstered

End table available in all oak and walnut finishes. When specifying light finish the natural characteristics of the wood will be visible and color will vary.

Ganging brackets are sold separately and will ship with the product. See Luca accessories page to order brackets. .

Power: Surface mount power provides (2) 15 amp receptables, (1) 2 amp USB-A port, 10 watt and (1) 2 amp USB-C port, 20 watt.

SCS Indoor Advantage™ Gold and LEVEL® 2 certified. See terms and conditions for additional finish and environmental information.

Seat Height	Arm Height	W	D	H	Fabric	Leather	Weight	Cubes/Qty
16½"	-	115¼"	28¾"	16½"	8.5 yds.	140.0'	181 lbs.	50.0'/1
419 mm	-	2921 mm	730 mm	419 mm	7.8 m	13.0 sqm	82.1 kg	1.40 cu.

COM	COL	1	2	3	4	5	6	7	8	9	10	11
4519	4689	5313	5445	5521	5672	5804	5861	5955	6087	6201	6333	7088

sku	frame finish	run-off top species	wood top finish
	6 polished aluminum standard, OR specify powder coat, upcharge \$200 3 matte black powder coat W satin white powder coat	C oak 9 walnut	see seating finishes

Luca Seating System Specification Guide

Standard Features



Luca is a modular seating system comprised of 41 unique modules which can be used as freestanding or interchangeably to create an unlimited number of configurations. Options include freestanding benches, two-seat and three-seat modules, corner modules and seating and bench modules with end tables. End table tops are available in oak or walnut and are offered with and without power. Legs are available in one of three finishes: polished aluminum, matte black powder coat and satin white powder coat.

Luca is fully upholstered with 5/8" diameter non-marring adjustable nylon glides. When ordering configurations, please provide the total COM yardage from the same dye lot in a continuous roll(s). All COM/COL fabrics must be preapproved by Bernhardt Design prior to application. SCS Indoor Advantage™ Gold and LEVEL® 2 certified. See terms and conditions for additional finish and environmental information.corporate office for specification assistance.

Configurations are connected by a ganging bracket. Ganging brackets are sold separately and will ship with product. See the Luca lounge-modular accessories page for ordering information.

Please visit BernhardtDesign.com for a complete library of 2D, 3D and Revit models. You may also contact your local sales representative or the Bernhardt Design corporate office for specification assistance.

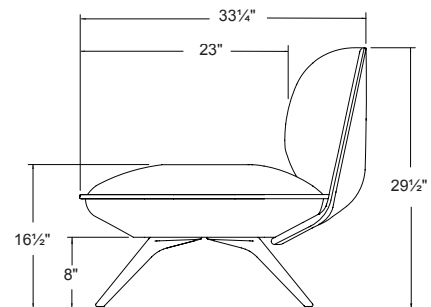

Side View of Armless Sofa

5/8" Non-marring Adjustable Nylon Glides

Leg Options

Polished Aluminum - 6

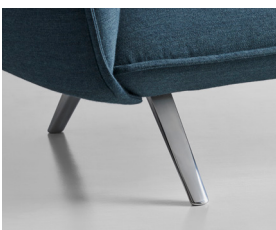

Matte Black Powder Coat - 3



Satin White Powder Coat - W

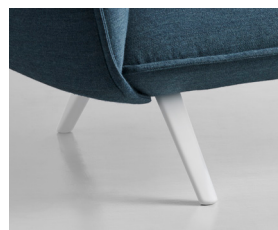
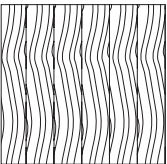

Table Options



Veneer Selection

OAK Oak
Order Code - C
Rift Cut



WLT Walnut
Order Code - 9
Flat Cut

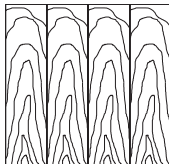

A three-character sku identifies each wood veneer option as well as standard finishes. Base and top finishes are specified separately. When selecting light finishes such as 836, 837, 840, or 870, the color and characteristic variances of the wood veneer are apparent, and exact color matches are not possible.

OAK Oak

Standard Finish		
871	860	870
837	836	861
865	805	866
872	839	845

WLT Walnut

Standard Finish	
872	861
860	823
839	866
870	

Standard Finish		
M73	M71	M75
M74	M76	M77

Edge Profile

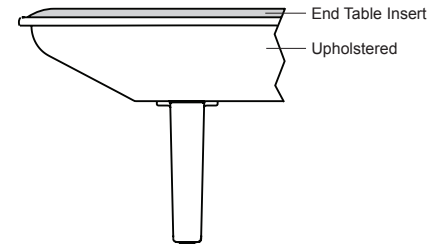

Surface Mount Power Modules

Luca offers a proprietary surface mount power solution which is installed flush to the worksurface and provides (2) 15 amp receptacles and (1) 2 amp USB-A port and (1) 2 amp USB-C port. The unit has a 10' infeed with a grounded plug. Power module finish is determined by leg finish selection.



Power Module
Power Module Finish
Black, Silver or White

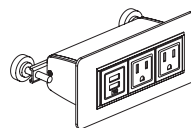

- (2) 120 v 60 Hz. 15 amp receptacles
- (1) 2 amp USB-A port, 10 watt
- (1) 2 amp USB-C port, 20 watt

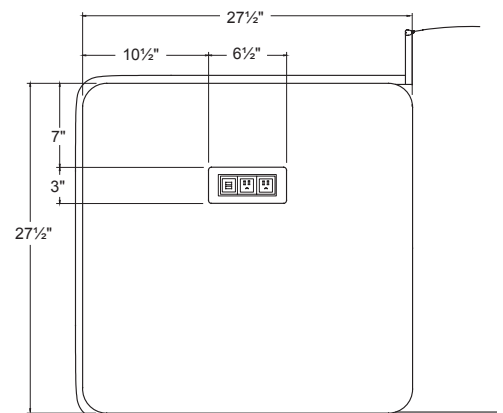

Connecting Modules



Luca modules connect by attaching a ganging bracket to the underside of the furniture. Order one ganging bracket per point of connection of modular units. Ganging brackets are sold separately and will ship with product.

To connect the modules together insert the three fasteners into the inserts at the location each module is desired to be connected. Push modules together in desired location.

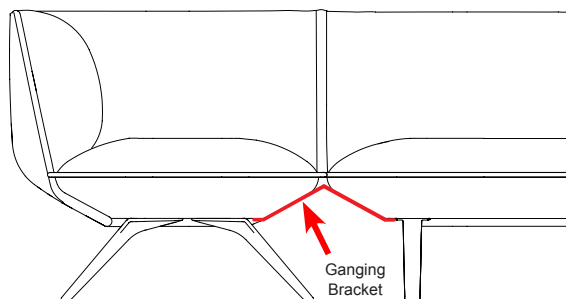

Ganging bracket is concealed behind flange and is not visible when looking at the sofa.

Leave 1/4" between head of fastener and upholstery. Fit bracket over heads of fasteners and slide bracket to lock fasteners into keyhole slots cut into fastener. Tighten fasteners against bracket.

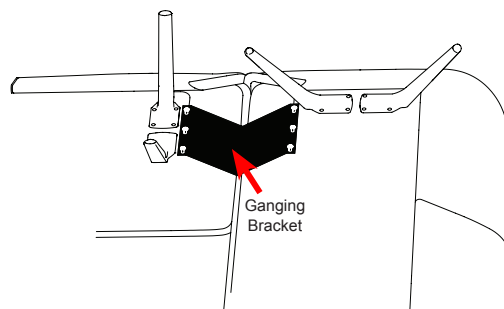

Under side view of the ganging bracket placement

Luca Seating System Sample Configurations

1	Sku	Description
	8P16R	Two-seat. Right Arm Facing Armless Module with End Table. Power
	8D27N	Three-Seat Module
2	8D05N	Two-seat Bench (Refer to Seating - Benches)
	8D47R	Three-seat. Right Arm Facing Armless Open Module
	8D57L	Three-seat. Left Arm Facing Open Module
	8D15N	Two-seat. Armless Module
3	8D37L	Three-seat. Left Arm Facing Module
	8D37L	Three-seat. Left Arm Facing Module
	8D37R	Three-seat. Right Arm Facing Module
	8D37R	Three-seat. Right Arm Facing Module
4	8D35L	Two-seat. Left Arm Facing Module
	8D31N	Inside 45° Corner Module. Armless
	8D35R	Two-seat. Right Arm Facing Module

Luca Seating System Sample Configurations

5

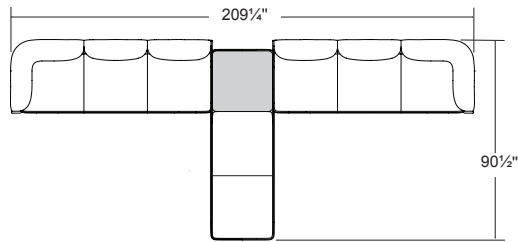
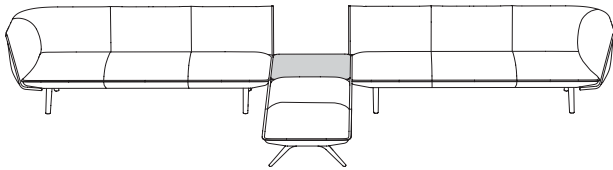

Sku **Description**

- 8D37L** Three-seat. Left Arm Facing Module
- 8D06N** Two-seat Bench with End Table (Refer to Seating - Benches)
- 8D37R** Three-seat. Right Arm Facing Module

6

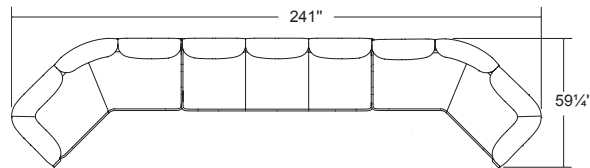
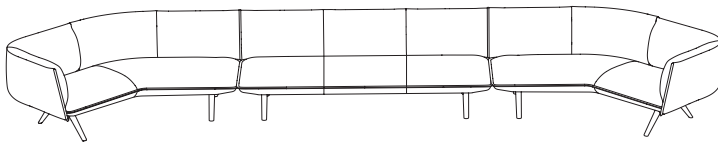

- 8D33L** Inside 45° Corner Module. Left Arm Facing
- 8D17N** Three-seat Armless Module
- 8D33R** Inside 45° Corner Module. Right Arm Facing

7

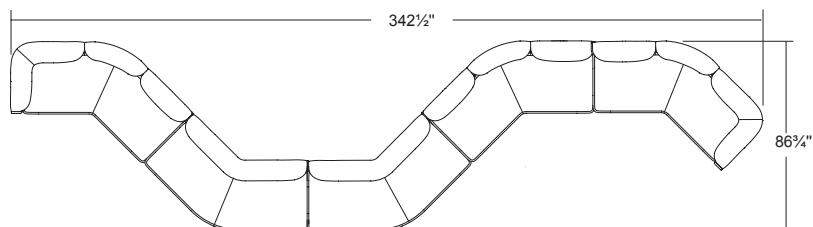
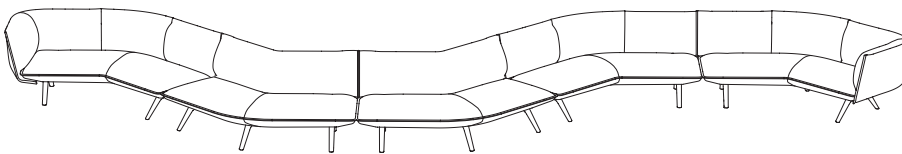

- 8D33L** Inside 45° Corner Module. Left Arm Facing
- 8D32N** Outside 45° Corner Module. Armless
- 8D32N** Outside 45° Corner Module. Armless
- 8D31N** Inside 45° Corner Module. Armless
- 8D33R** Inside 45° Corner Module. Right Arm Facing

luca 8D25N

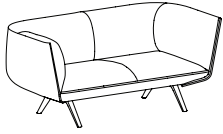

Loveseat
Polished aluminum or powder coat legs
Upholstered

When using a combination of fabrics or leathers, specify the application by designating the appropriate letter, shown below, on the purchase order. Yardage shown must be used.

See terms and conditions for contrasting upholstery upcharges.

- A) One fabric or leather for seat
yardage: 4.5 yds. leather: 73.0 sq. ft.
- B) One fabric or leather for inside back, outside back, outer shell and inside arms
yardage: 7.5 yds. leather: 122.0 sq. ft.

SCS Indoor Advantage™ Gold and LEVEL® 2 certified. See terms and conditions for instructions for additional environmental information.

Seat Height	Arm Height	W	D	H	Fabric	Leather	Weight	Cubes/Qty
16½"	29 ½"	66½"	33 ¼"	29½"	12.0 yds.	195.0'	165 lbs.	52.25'/1
419 mm	749 mm	1689 mm	845 mm	749 mm	11 m	18.1 sqm	74.9 kg	1.50 cu.

COM	COL	1	2	3	4	5	6	7	8	9	10	11
4866	5106	5986	6173	6280	6493	6680	6760	6893	7080	7240	7426	8493

luca 8D27N

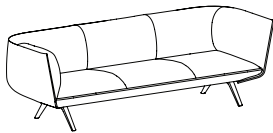

Sofa
Polished aluminum or powder coat legs
Upholstered

When using a combination of fabrics or leathers, specify the application by designating the appropriate letter, shown below, on the purchase order. Yardage shown must be used.

See terms and conditions for contrasting upholstery upcharges.

- A) One fabric or leather for seat
yardage: 6.75 yds. leather: 110.0 sq. ft.
- B) One fabric or leather for inside back, outside back, outer shell and inside arms.
yardage: 10.0 yds. leather: 165.0 sq. ft.

SCS Indoor Advantage™ Gold and LEVEL® 2 certified. See terms and conditions for additional environmental information.

Seat Height	Arm Height	W	D	H	Fabric	Leather	Weight	Cubes/Qty
16½"	29½"	95½"	33¼"	29½"	16.75 yds.	275.0'	216 lbs.	71.85'/1
419 mm	749 mm	2432 mm	845 mm	749 mm	15.32 m	25.5 sqm	98.2 kg	2.03 cu.

COM	COL	1	2	3	4	5	6	7	8	9	10	11
5979	6314	7543	7803	7952	8250	8511	8622	8808	9069	9292	9553	11042

sku

frame finish

--	--	--	--	--	--	--	--	--	--	--	--	--

- 6** polished aluminum standard, OR
specify powder coat, upcharge \$200
- 3** matte black powder coat
- W** satin white powder coat

luca 8D25N

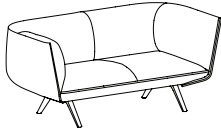

Two-seat module
Use for making 90° corner configurations
Polished aluminum or powder coat legs
Upholstered

Ganging brackets are sold separately and will ship with the product. See Luca accessories page to order brackets.

When using a combination of fabrics or leathers, specify the application by designating the appropriate letter, shown below, on the purchase order. Yardage shown must be used.

See terms and conditions for contrasting upholstery upcharges.

- A) One fabric or leather for seat
 yardage: 4.5 yds. leather: 73.0 sq. ft.
- B) One fabric or leather for inside back, outside back, outer shell and inside arms
 yardage: 9.0 yds. leather: 146.0 sq. ft.

SCS Indoor Advantage™ Gold and LEVEL® 2 certified. See terms and conditions for additional environmental information.

Seat Height	Arm Height	W	D	H	Fabric	Leather	Weight	Cubes/Qty
16½"	29 ½"	66½"	33 ¼"	29½"	12.0 yds.	195.0'	165 lbs.	52.25/1
419 mm	749 mm	1689 mm	845 mm	749 mm	11 m	18.1 sqm	74.9 kg	1.50 cu.

COM	COL	1	2	3	4	5	6	7	8	9	10	11
4866	5106	5986	6173	6280	6493	6680	6760	6893	7080	7240	7426	8493

luca 8D35L

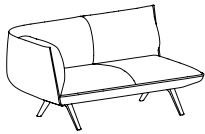

Two-seat module
Left arm facing
Polished aluminum or powder coat legs
Upholstered

Ganging brackets are sold separately and will ship with the product. See Luca accessories page to order brackets.

When using a combination of fabrics or leathers, specify the application by designating the appropriate letter, shown below, on the purchase order. Yardage shown must be used.

See terms and conditions for contrasting upholstery upcharges.

- A) One fabric or leather for seat
 yardage: 5.0 yds. leather: 81.0 sq. ft.
- B) One fabric or leather for inside back, outside back, outer shell and inside arm
 yardage: 7.0 yds. leather: 114.0 sq. ft.

SCS Indoor Advantage™ Gold and LEVEL® 2 certified. See terms and conditions for additional environmental information.

Seat Height	Arm Height	W	D	H	Fabric	Leather	Weight	Cubes/Qty
16½"	29½"	62¾"	33¼"	29½"	11.0 yds.	180.0'	151 lbs.	52.25/1
419 mm	749 mm	1594 mm	845 mm	749 mm	10.1 m	16.7 sqm	68.5 kg	1.50 cu.

COM	COL	1	2	3	4	5	6	7	8	9	10	11
4311	4531	5338	5509	5607	5803	5974	6047	6169	6340	6487	6658	7636

sku

frame finish

--	--	--	--	--	--	--	--	--	--	--	--	--

- 6** polished aluminum standard, OR
- specify powder coat, upcharge \$200
- 3** matte black powder coat
- W** satin white powder coat

luca 8D35R

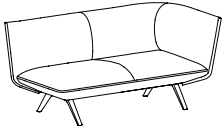

Two-seat module
Right arm facing
Polished aluminum or powder coat legs
Upholstered

Ganging brackets are sold separately and will ship with the product. See Luca accessories page to order brackets.

When using a combination of fabrics or leathers, specify the application by designating the appropriate letter, shown below, on the purchase order. Yardage shown must be used.

See terms and conditions for contrasting upholstery upcharges.

- A) One fabric or leather for seat
yardage: 5.0 yds. leather: 81.0 sq. ft.
- B) One fabric or leather for inside back, outside back, outer shell and inside arm
yardage: 7.0 yds. leather: 114.0 sq. ft.

SCS Indoor Advantage™ Gold and LEVEL® 2 certified. See terms and conditions for additional environmental information.

Seat Height	Arm Height	W	D	H	Fabric	Leather	Weight	Cubes/Qty
16½"	29½"	62¾"	33¼"	29½"	11.0 yds.	180.0'	151 lbs.	52.25/1
419 mm	749 mm	1594 mm	845 mm	749 mm	10.1 m	16.7 sqm	68.5 kg	1.50 cu.

COM	COL	1	2	3	4	5	6	7	8	9	10	11
4311	4531	5338	5509	5607	5803	5974	6047	6169	6340	6487	6658	7636

luca 8D15N

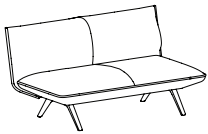

Two-seat armless module
Polished aluminum or powder coat legs
Upholstered

Ganging brackets are sold separately and will ship with the product. See Luca accessories page to order brackets.

When using a combination of fabrics or leathers, specify the application by designating the appropriate letter, shown below, on the purchase order. Yardage shown must be used.

See terms and conditions for contrasting upholstery upcharges.

- A) One fabric or leather for seat
yardage: 4.5 yds. leather: 73.0 sq. ft.
- B) One fabric or leather for inside back and outside back
yardage: 4.5 yds. leather: 73.0 sq. ft.

SCS Indoor Advantage™ Gold and LEVEL® 2 certified. See terms and conditions for additional environmental information.

Seat Height	Arm Height	W	D	H	Fabric	Leather	Weight	Cubes/Qty
16½"	-	58½"	33¼"	29½"	9.5 yds.	160.0'	128 lbs.	52.25/1
419 mm	-	1486 mm	845 mm	749 mm	8.7 m	14.7 sqm	58.1 kg	1.50 cu.

COM	COL	1	2	3	4	5	6	7	8	9	10	11
3616	3806	4503	4651	4735	4904	5052	5115	5221	5369	5495	5643	6488

sku

frame finish

--	--	--	--	--	--	--	--	--	--	--	--	--

- 6** polished aluminum standard, OR
- specify powder coat, upcharge \$200
- 3** matte black powder coat
- W** satin white powder coat

luca 8D55L

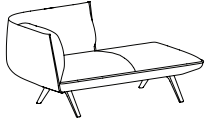

Two-seat open module
Left arm facing
Polished aluminum or powder coat legs
Upholstered

Ganging brackets are sold separately and will ship with the product. See Luca accessories page to order brackets.

When using a combination of fabrics or leathers, specify the application by designating the appropriate letter, shown below, on the purchase order. Yardage shown must be used.

See terms and conditions for contrasting upholstery upcharges.

- A) One fabric or leather for seat
yardage: 5.0 yds. leather: 81.0 sq. ft.
- B) One fabric or leather for insided back, outside back, outer shell and inside arm
yardage: 5.25 yds. leather: 85.0 sq. ft.

SCS Indoor Advantage™ Gold and LEVEL® 2 certified. See terms and conditions for additional environmental information.

Seat Height	Arm Height	W	D	H	Fabric	Leather	Weight	Cubes/Qty
16½"	29½"	62¾"	33¼"	29½"	9.0 yds.	150.0'	135 lbs.	52.25/1
419 mm	749 mm	1594 mm	845 mm	749 mm	8.2 m	13.9 sqm	61.2 kg	1.50 cu.

COM	COL	1	2	3	4	5	6	7	8	9	10	11
3893	4073	4733	4873	4953	5113	5253	5313	5413	5553	5673	5813	6613

luca 8D55R

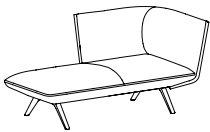

Two-seat open module
Right arm facing
Polished aluminum or powder coat legs
Upholstered

Ganging brackets are sold separately and will ship with the product. See Luca accessories page to order brackets.

When using a combination of fabrics or leathers, specify the application by designating the appropriate letter, shown below, on the purchase order. Yardage shown must be used.

See terms and conditions for contrasting upholstery upcharges.

- A) One fabric or leather for seat
yardage: 5.0 yds. leather: 81.0 sq. ft.
- B) One fabric or leather for inside back, outside back, outer shell and inside arm
yardage: 5.25 yds. leather: 85.0 sq. ft.

SCS Indoor Advantage™ Gold and LEVEL® 2 certified. See terms and conditions for additional environmental information.

Seat Height	Arm Height	W	D	H	Fabric	Leather	Weight	Cubes/Qty
16½"	29½"	62¾"	33¼"	29½"	9.0 yds.	150.0'	135 lbs.	52.25/1
419 mm	749 mm	1594 mm	845 mm	749 mm	8.2 m	13.9 sqm	61.2 kg	1.50 cu.

COM	COL	1	2	3	4	5	6	7	8	9	10	11
3893	4073	4733	4873	4953	5113	5253	5313	5413	5553	5673	5813	6613

sku

frame finish

--	--	--	--	--	--	--	--	--	--	--	--	--

- 6** polished aluminum standard, OR
- specify powder coat, upcharge \$200
- 3** matte black powder coat
- W** satin white powder coat

luca 8D45L

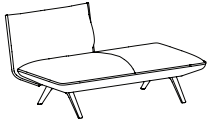

Two-seat armless open module
Left side facing
Polished aluminum or powder coat legs
Upholstered

Ganging brackets are sold separately and will ship with the product. See Luca accessories page to order brackets.

When using a combination of fabrics or leathers, specify the application by designating the appropriate letter, shown below, on the purchase order. Yardage shown must be used.

See terms and conditions for contrasting upholstery upcharges.

- A) One fabric or leather for seat
 yardage: 5.25 yds. leather: 85.0 sq. ft.
- B) One fabric or leather for inside back and outside back
 yardage: 3.0 yds. leather: 50.0 sq. ft.

SCS Indoor Advantage™ Gold and LEVEL® 2 certified. See terms and conditions for additional environmental information.

Seat Height	Arm Height	W	D	H	Fabric	Leather	Weight	Cubes/Qty
16½"	-	58½"	33¼"	29½"	7.5 yds.	125.0'	112 lbs.	52.25/1
419 mm	-	1486 mm	845 mm	749 mm	6.9 m	11.6 sqm	50.9 kg	1.50 cu.

COM	COL	1	2	3	4	5	6	7	8	9	10	11
3198	3348	3898	4015	4082	4215	4332	4382	4465	4582	4682	4798	5465

luca 8D45R

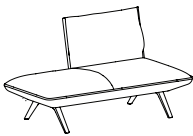

Two-seat armless open module
Right side facing
Polished aluminum or powder coat legs
Upholstered

Ganging brackets are sold separately and will ship with the product. See Luca accessories page to order brackets.

When using a combination of fabrics or leathers, specify the application by designating the appropriate letter, shown below, on the purchase order. Yardage shown must be used.

See terms and conditions for contrasting upholstery upcharges.

- A) One fabric or leather for seat
 yardage: 5.25 yds. leather: 85.0 sq. ft.
- B) One fabric or leather for inside back and outside back
 yardage: 3.0 yds. leather: 50.0 sq. ft.

SCS Indoor Advantage™ Gold and LEVEL® 2 certified. See terms and conditions for additional environmental information.

Seat Height	Arm Height	W	D	H	Fabric	Leather	Weight	Cubes/Qty
16½"	-	58½"	33¼"	29½"	7.5 yds.	125.0'	112 lbs.	52.25/1
419 mm	-	1486 mm	845 mm	749 mm	6.9 m	11.6 sqm	50.9 kg	1.50 cu.

COM	COL	1	2	3	4	5	6	7	8	9	10	11
3198	3348	3898	4015	4082	4215	4332	4382	4465	4582	4682	4798	5465

sku

frame finish

--	--	--	--	--	--	--	--	--	--	--	--	--

- 6** polished aluminum standard, OR
- specify powder coat, upcharge \$200
- 3** matte black powder coat
- W** satin white powder coat

luca 8D27N

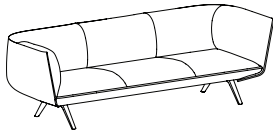

Three-seat module
Use for making 90° corner configurations
Polished aluminum or powder coat legs
Upholstered

Ganging brackets are sold separately and will ship with the product. See Luca accessories page to order brackets.

When using a combination of fabrics or leathers, specify the application by designating the appropriate letter, shown below, on the purchase order. Yardage shown must be used.

See terms and conditions for contrasting upholstery upcharges.

- A) One fabric or leather for seat
 yardage: 6.75 yds. leather: 110.0 sq. ft.
- B) One fabric or leather for inside back, outside back, outer shell and inside arms
 yardage: 11.25 yds. leather: 183.0 sq. ft.

SCS Indoor Advantage™ Gold and LEVEL® 2 certified. See terms and conditions for additional environmental information.

Seat Height	Arm Height	W	D	H	Fabric	Leather	Weight	Cubes/Qty
16½"	29½"	95¾"	33¼"	29½"	16.75 yds.	275.0'	216 lbs.	71.85/1
419 mm	749 mm	2432 mm	845 mm	749 mm	15.32 m	25.5 sqm	98.2 kg	2.03 cu.

COM	COL	1	2	3	4	5	6	7	8	9	10	11
5979	6314	7543	7803	7952	8250	8511	8622	8808	9069	9292	9553	11042

luca 8D37L

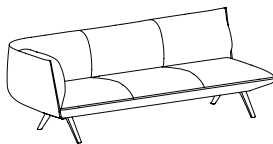

Three-seat module
Left arm facing
Polished aluminum or powder coat legs
Upholstered

Ganging brackets are sold separately and will ship with the product. See Luca accessories page to order brackets. ts.

When using a combination of fabrics or leathers, specify the application by designating the appropriate letter, shown below, on the purchase order. Yardage shown must be used.

See terms and conditions for contrasting upholstery upcharges.

- A) One fabric or leather for seat
 yardage: 7.0 yds. leather: 114.0 sq. ft.
- B) One fabric or leather for inside back, outside back, outer shell and inside arm
 yardage: 9.5 yds. leather: 154.0 sq. ft.

SCS Indoor Advantage™ Gold and LEVEL® 2 certified. See terms and conditions for additional environmental information.

Seat Height	Arm Height	W	D	H	Fabric	Leather	Weight	Cubes/Qty
16½"	29½"	91¼"	33¼"	29½"	13.25 yds.	215.0'	202 lbs.	71.85/1
419 mm	749 mm	2318 mm	845 mm	749 mm	12.1 m	20.0 sqm	91.6 kg	2.03 cu.

COM	COL	1	2	3	4	5	6	7	8	9	10	11
5422	5687	6659	6865	6983	7219	7425	7513	7660	7866	8043	8249	9427

sku

frame finish

--	--	--	--	--	--	--	--	--	--	--	--	--

- 6** polished aluminum standard, OR
- specify powder coat, upcharge \$200
- 3** matte black powder coat
- W** satin white powder coat

luca 8D37R

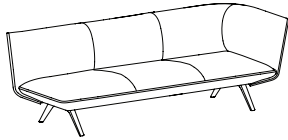

Three-seat module
Right arm facing
Polished aluminum or powder coat legs
Upholstered

Ganging brackets are sold separately and will ship with the product. See Luca accessories page to order brackets.

When using a combination of fabrics or leathers, specify the application by designating the appropriate letter, shown below, on the purchase order. Yardage shown must be used.

See terms and conditions for contrasting upholstery upcharges.

- A) One fabric or leather for seat
yardage: 7.0 yds. leather: 114.0 sq. ft.
- B) One fabric or leather for inside back, outside back, outer shell and inside arms
yardage: 9.5 yds. leather: 154.0 sq. ft.

SCS Indoor Advantage™ Gold and LEVEL® 1 certified. See terms and conditions for additional environmental information.

Seat Height	Arm Height	W	D	H	Fabric	Leather	Weight	Cubes/Qty
16½"	29½"	91¼"	33¼"	29½"	13.25 yds.	215.0'	202 lbs.	71.85/1
419 mm	749 mm	2318 mm	845 mm	749 mm	12.1 m	20.0 sqm	91.6 kg	2.03 cu.

COM	COL	1	2	3	4	5	6	7	8	9	10	11
5422	5687	6659	6865	6983	7219	7425	7513	7660	7866	8043	8249	9427

luca 8D17N

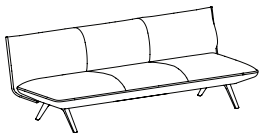

Three-seat module
Armless
Polished aluminum or powder coat legs
Upholstered

When using a combination of fabrics or leathers, specify the application by designating the appropriate letter, shown below, on the purchase order. Yardage shown must be used.

See terms and conditions for contrasting upholstery upcharges.

- A) One fabric or leather for seat
yardage: 7.5 yds. leather: 122.0 sq. ft.
- B) One fabric or leather for inside back and outside back
yardage: 7.5 yds. leather: 122.0 sq. ft.

SCS Indoor Advantage™ Gold and LEVEL® 1 certified. See terms and conditions for additional environmental information.

Seat Height	Arm Height	W	D	H	Fabric	Leather	Weight	Cubes/Qty
16½"	-	87¼"	33 ¼"	29 ½"	12.5 yds.	203.0'	181 lbs.	71.85/1
419 mm	-	2216 mm	845 mm	749 mm	11.3 m	18.9 sqm	82.1 kg	2.03 cu.

COM	COL	1	2	3	4	5	6	7	8	9	10	11
4728	4978	5895	6090	6201	6423	6617	6701	6840	7034	7201	7395	8506

sku

frame finish

--	--	--	--	--	--	--	--	--	--	--	--	--

- 6** polished aluminum standard, OR
- specify powder coat, upcharge \$200
- 3** matte black powder coat
- W** satin white powder coat

luca 8D57L

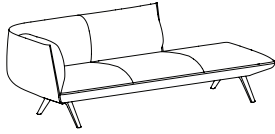

Three-seat open module
Left arm facing
Polished aluminum or powder coat legs
Upholstered

Ganging brackets are sold separately and will ship with the product. See Luca accessories page to order brackets.

When using a combination of fabrics or leathers, specify the application by designating the appropriate letter, shown below, on the purchase order. Yardage shown must be used.

See terms and conditions for contrasting upholstery upcharges.

- A) One fabric or leather for seat
 yardage: 7.0 yds. leather: 114.0 sq. ft.
- B) One fabric or leather for inside back, outside back, outer shell and inside arms
 yardage: 7.5 yds. leather: 122.0 sq. ft.

SCS Indoor Advantage™ Gold and LEVEL® 2 certified. See terms and conditions for additional environmental information.

Seat Height	Arm Height	W	D	H	Fabric	Leather	Weight	Cubes/Qty
16½"	29½"	91¼"	33¼"	29½"	11.75 yds.	190.0'	190 lbs.	71.85/1
419 mm	749 mm	2318 mm	845 mm	749 mm	10.7 m	17.7 sqm	86.2 kg	2.03 cu.

COM	COL	1	2	3	4	5	6	7	8	9	10	11
5006	5241	6103	6286	6390	6599	6782	6860	6991	7174	7330	7513	8558

luca 8D57R

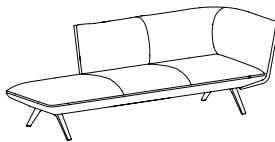

Three-seat open module
Right arm facing
Polished aluminum or powder coat legs
Upholstered

Ganging brackets are sold separately and will ship with the product. See Luca accessories page to order brackets.

When using a combination of fabrics or leathers, specify the application by designating the appropriate letter, shown below, on the purchase order. Yardage shown must be used.

See terms and conditions for contrasting upholstery upcharges.

- A) One fabric or leather for seat
 yardage: 7.0 yds. leather: 114.0 sq. ft.
- B) One fabric or leather for inside back, outside back, outer shell and inside arms
 yardage: 7.5 yds. leather: 122.0 sq. ft.

SCS Indoor Advantage™ Gold and LEVEL® 2 certified. See terms and conditions for additional environmental information.

Seat Height	Arm Height	W	D	H	Fabric	Leather	Weight	Cubes/Qty
16½"	29½"	91¼"	33¼"	29½"	11.75 yds.	190.0'	190 lbs.	71.85/1
419 mm	749 mm	2318 mm	845 mm	749 mm	10.7 m	17.7 sqm	86.2 kg	2.03 cu.

COM	COL	1	2	3	4	5	6	7	8	9	10	11
5006	5241	6103	6286	6390	6599	6782	6860	6991	7174	7330	7513	8558

sku

frame finish

--	--	--	--	--	--	--	--	--	--	--	--	--

- 6** polished aluminum standard, OR
- specify powder coat, upcharge \$200
- 3** matte black powder coat
- W** satin white powder coat

luca 8D47L

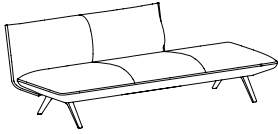

Three-seat armless open module
Left side facing
Polished aluminum or powder coat legs
Upholstered

Ganging brackets are sold separately and will ship with the product. See Luca accessories page to order brackets.

When using a combination of fabrics or leathers, specify the application by designating the appropriate letter, shown below, on the purchase order. Yardage shown must be used.

See terms and conditions for contrasting upholstery upcharges.

- A) One fabric or leather for seat
 yardage: 7.5 yds. leather: 122.0 sq. ft.
- B) One fabric or leather for inside back and outside back
 yardage: 5.25 yds. leather: 85.0 sq. ft.

SCS Indoor Advantage™ Gold and LEVEL® 1 certified. See terms and conditions for additional environmental information.

Seat Height	Arm Height	W	D	H	Fabric	Leather	Weight	Cubes/Qty
16½"	-	87¼"	33¼"	29½"	10.75 yds.	175.0'	165 lbs.	71.85/1
419 mm	-	2216 mm	845 mm	749 mm	9.8 m	16.3 sqm	74.8 kg	2.03 cu.

COM	COL	1	2	3	4	5	6	7	8	9	10	11
4311	4526	5315	5482	5578	5769	5936	6008	6127	6294	6438	6605	7560

luca 8D47R

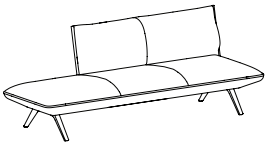

Three-seat armless open module
Right side facing
Polished aluminum or powder coat legs
Upholstered

Ganging brackets are sold separately and will ship with the product. See Luca accessories page to order brackets.

When using a combination of fabrics or leathers, specify the application by designating the appropriate letter, shown below, on the purchase order. Yardage shown must be used.

See terms and conditions for contrasting upholstery upcharges.

- A) One fabric or leather for seat
 yardage: 7.5 yds. leather: 122.0 sq. ft.
- B) One fabric or leather for inside back and outside back
 yardage: 5.25 yds. leather: 85.0 sq. ft.

SCS Indoor Advantage™ Gold and LEVEL® 1 certified. See terms and conditions for additional environmental information.

Seat Height	Arm Height	W	D	H	Fabric	Leather	Weight	Cubes/Qty
16½"	-	87¼"	33¼"	29½"	10.75 yds.	175.0'	165 lbs.	71.85/1
419 mm	-	2216 mm	845 mm	749 mm	9.8 m	16.3 sqm	74.8 kg	2.03 cu.

COM	COL	1	2	3	4	5	6	7	8	9	10	11
4311	4526	5315	5482	5578	5769	5936	6008	6127	6294	6438	6605	7560

sku

frame finish

--	--	--	--	--	--	--	--	--	--	--	--	--

- 6** polished aluminum standard, OR
- specify powder coat, upcharge \$200
- 3** matte black powder coat
- W** satin white powder coat

luca 8D26L

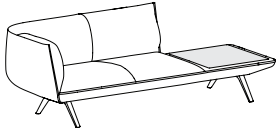

Two-seat module with end table
Left arm facing
Polished aluminum or powder coat legs
Upholstered

End table available in all oak and walnut finishes. When specifying light finish the natural characteristics of the wood will be visible and color will vary.

Ganging brackets are sold separately and will ship with the product. See Luca accessories page to order brackets.

When using a combination of fabrics or leathers, specify the application by designating the appropriate letter, shown below, on the purchase order. Yardage shown must be used.

See terms and conditions for contrasting upholstery upcharges.

- A) One fabric or leather for seat
 yardage: 6.5 yds. leather: 105.0 sq. ft.
- B) One fabric or leather for inside back, outside back, outer shell and inside arm
 yardage: 5.0 yds. leather: 82.0 sq. ft.

SCS Indoor Advantage™ Gold and LEVEL® 2 certified. See terms and conditions for additional finish and environmental information.

Seat Height	Arm Height	W	D	H	Fabric	Leather	Weight	Cubes/Qty
16½"	29½"	90¼"	33¼"	29½"	11.5 yds.	190.0'	209 lbs.	71.85'/1
419 mm	749 mm	2286 mm	845 mm	749 mm	10.5 m	17.7 sqm	94.8 kg	2.03 cu.

COM	COL	1	2	3	4	5	6	7	8	9	10	11
5561	5791	6635	6814	6916	7120	7299	7376	7504	7683	7836	8015	9037

sku	frame finish	run-off top species	wood top finish
	6 polished aluminum standard, OR specify powder coat, upcharge \$200 3 matte black powder coat W satin white powder coat	C oak 9 walnut	see seating finishes

luca 8P26L

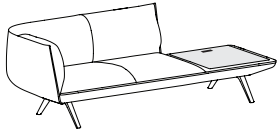

Power
Two-seat module with end table
Left side facing
Polished aluminum or powder coat legs
Upholstered

End table available in all oak and walnut finishes. When specifying light finish the natural characteristics of the wood will be visible and color will vary.

Ganging brackets are sold separately and will ship with the product. See Luca accessories page to order brackets.

Power: Surface mount power provides (2) 15 amp receptables, (1) 2 amp USB-A port, 10 watt and (1) 2 amp USB-C port, 20 watt.

When using a combination of fabrics or leathers, specify the application by designating the appropriate letter, shown below, on the purchase order. Yardage shown must be used.

See terms and conditions for contrasting upholstery upcharges.

- A) One fabric or leather for seat
 yardage: 6.5 yds. leather: 105.0 sq. ft.
- B) One fabric or leather for inside back, outside back, outer shell and inside arms
 yardage: 5.0 yds. leather: 82.0 sq. ft.

SCS Indoor Advantage™ Gold and LEVEL® 2 certified. See terms and conditions for additional finish and environmental information.

Seat Height	Arm Height	W	D	H	Fabric	Leather	Weight	Cubes/Qty
16½"	29½"	90¼"	33¼"	29½"	11.5 yds.	190.0'	212 lbs.	71.85/1
419 mm	749 mm	2286 mm	845 mm	749 mm	10.5 m	17.7 sqm	96.2 kg	2.03 cu.

COM	COL	1	2	3	4	5	6	7	8	9	10	11
6326	6556	7400	7579	7681	7885	8064	8141	8269	8448	8601	8780	9802

sku	frame finish	run-off top species	wood top finish
	6 polished aluminum standard, OR specify powder coat, upcharge \$200 3 matte black powder coat W satin white powder coat	C oak 9 walnut	see seating finishes

luca 8D26R

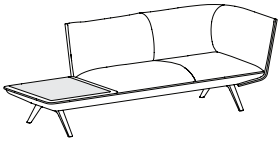

Two-seat module with end table
Right arm facing
Polished aluminum or powder coat legs
Upholstered

End table available in all oak and walnut finishes. When specifying light finish the natural characteristics of the wood will be visible and color will vary.

Ganging brackets are sold separately and will ship with the product. See Luca accessories page to order brackets.

When using a combination of fabrics or leathers, specify the application by designating the appropriate letter, shown below, on the purchase order. Yardage shown must be used.

See terms and conditions for contrasting upholstery upcharges.

- A) One fabric or leather for seat
 yardage: 6.5 yds. leather: 105.0 sq. ft.
- B) One fabric or leather for inside back, outside back, outer shell and inside arm
 yardage: 5.0 yds. leather: 82.0 sq. ft.

SCS Indoor Advantage™ Gold and LEVEL® 2 certified. See terms and conditions for additional finish and environmental information.

Seat Height	Arm Height	W	D	H	Fabric	Leather	Weight	Cubes/Qty
16½"	29½"	90¼"	33¼"	29½"	11.5 yds.	190.0'	209 lbs.	71.85'/1
419 mm	749 mm	2286 mm	845 mm	749 mm	10.5 m	17.7 sqm	94.8 kg	2.03 cu.

COM	COL	1	2	3	4	5	6	7	8	9	10	11
5561	5791	6635	6814	6916	7120	7299	7376	7504	7683	7836	8015	9037

sku	frame finish	run-off top species	wood top finish
	6 polished aluminum standard, OR specify powder coat, upcharge \$200 3 matte black powder coat W satin white powder coat	C oak 9 walnut	see seating finishes

luca 8P26R

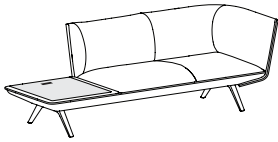

Power
Two-seat module with end table
Right side facing
Polished aluminum or powder coat legs
Upholstered

End table available in all oak and walnut finishes. When specifying light finish the natural characteristics of the wood will be visible and color will vary.

Ganging brackets are sold separately and will ship with the product. See Luca accessories page to order brackets.

Power: Surface mount power provides (2) 15 amp receptacles, (1) 2 amp USB-A port, 10 watt and (1) 2 amp USB-C port, 20 watt.

When using a combination of fabrics or leathers, specify the application by designating the appropriate letter, shown below, on the purchase order. Yardage shown must be used.

See terms and conditions for contrasting upholstery upcharges.

- A) One fabric or leather for seat
 yardage: 6.5 yds. leather: 105.0 sq. ft.
- B) One fabric or leather for inside back, outside back, outer shell and inside arms
 yardage: 5.0 yds. leather: 82.0 sq. ft.

SCS Indoor Advantage™ Gold and LEVEL® 2 certified. See terms and conditions for additional finish and environmental information.

Seat Height	Arm Height	W	D	H	Fabric	Leather	Weight	Cubes/Qty
16½"	29½"	90¼"	33¼"	29½"	11.5 yds.	190.0'	212 lbs.	71.85/1
419 mm	749 mm	2286 mm	845 mm	749 mm	10.5 m	17.7 sqm	96.2 kg	2.03 cu.

COM	COL	1	2	3	4	5	6	7	8	9	10	11
6326	6556	7400	7579	7681	7885	8064	8141	8269	8448	8601	8780	9802

sku	frame finish	run-off top species	wood top finish
	6 polished aluminum standard, OR specify powder coat, upcharge \$200 3 matte black powder coat W satin white powder coat	C oak 9 walnut	see seating finishes

luca 8D16L

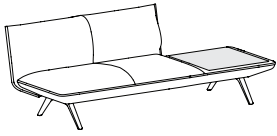

Two-seat armless module with end table
Left side facing
Polished aluminum or powder coat legs
Upholstered

End table available in all oak and walnut finishes. When specifying light finish the natural characteristics of the wood will be visible and color will vary.

Ganging brackets are sold separately and will ship with the product. See Luca accessories page to order brackets.

When using a combination of fabrics or leathers, specify the application by designating the appropriate letter, shown below, on the purchase order. Yardage shown must be used.

See terms and conditions for contrasting upholstery upcharges.

- A) One fabric or leather for seat
 yardage: 6.5 yds. leather: 105.0 sq. ft.
- B) One fabric or leather for inside back and outside back
 yardage: 3.0 yds. leather: 50.0 sq. ft.

SCS Indoor Advantage™ Gold and LEVEL® 2 certified. See terms and conditions for additional finish and environmental information.

Seat Height	Arm Height	W	D	H	Fabric	Leather	Weight	Cubes/Qty
16½"	-	86¼"	33¼"	29 ½"	9.5 yds.	160.0'	195 lbs.	71.85'/1
419 mm	-	2191 mm	845 mm	749 mm	8.7 m	14.9 sqm	88.5 kg	2.03 cu.

COM	COL	1	2	3	4	5	6	7	8	9	10	11
4866	5056	5753	5901	5985	6154	6302	6365	6471	6619	6745	6893	7738

sku	frame finish	run-off top species	wood top finish
	6 polished aluminum standard, OR specify powder coat, upcharge \$200 3 matte black powder coat W satin white powder coat	C oak 9 walnut	see seating finishes

luca 8P16L

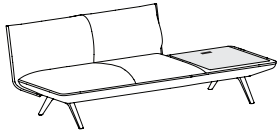

Power
Two-seat armless module with end table
Left side facing
Polished aluminum or powder coat legs
Upholstered

End table available in all oak and walnut finishes. When specifying light finish the natural characteristics of the wood will be visible and color will vary.

Ganging brackets are sold separately and will ship with the product. See Luca accessories page to order brackets.

Power: Surface mount power provides (2) 15 amp receptacles, (1) 2 amp USB-A port, 10 watt and (1) 2 amp USB-C port, 20 watt.

When using a combination of fabrics or leathers, specify the application by designating the appropriate letter, shown below, on the purchase order. Yardage shown must be used.

See terms and conditions for contrasting upholstery upcharges.

- A) One fabric or leather for seat
 yardage: 6.5 yds. leather: 105.0 sq. ft.
- B) One fabric or leather for inside back and outside back
 yardage: 3.0 yds. leather: 50.0 sq. ft.

SCS Indoor Advantage™ Gold and LEVEL® 2 certified. See terms and conditions for additional finish and environmental information.

Seat Height	Arm Height	W	D	H	Fabric	Leather	Weight	Cubes/Qty
16½"	-	86¼"	33¼"	29½"	9.5 yds.	160.0'	198 lbs.	71.85/1
419 mm	-	2191 mm	845 mm	749 mm	8.7 m	14.9 sqm	89.8 kg	2.03 cu.

COM	COL	1	2	3	4	5	6	7	8	9	10	11
5632	5822	6519	6667	6751	6920	7068	7131	7237	7385	7511	7659	8504

sku	frame finish	run-off top species	wood top finish
	6 polished aluminum standard, OR specify powder coat, upcharge \$200 3 matte black powder coat W satin white powder coat	C oak 9 walnut	see seating finishes

luca 8D16R

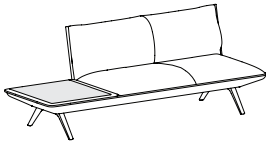

Two-seat armless module with end table
Right side facing
Polished aluminum or powder coat legs
Upholstered

End table available in all oak and walnut finishes. When specifying light finish the natural characteristics of the wood will be visible and color will vary.

Ganging brackets are sold separately and will ship with the product. See Luca accessories page to order brackets.

When using a combination of fabrics or leathers, specify the application by designating the appropriate letter, shown below, on the purchase order. Yardage shown must be used.

See terms and conditions for contrasting upholstery upcharges.

- A) One fabric or leather for seat
 yardage: 6.5 yds. leather: 105.0 sq. ft.
- B) One fabric or leather for inside back and outside back
 yardage: 3.0 yds. leather: 50.0 sq. ft.

SCS Indoor Advantage™ Gold and LEVEL® 2 certified. See terms and conditions for additional finish and environmental information.

Seat Height	Arm Height	W	D	H	Fabric	Leather	Weight	Cubes/Qty
16½"	-	86¼"	33¼"	29½"	9.5 yds.	160.0'	195 lbs.	71.85'/1
419 mm	-	2191 mm	845 mm	749 mm	8.7 m	14.9 sqm	88.5 kg	2.03 cu.

COM	COL	1	2	3	4	5	6	7	8	9	10	11
4866	5056	5753	5901	5985	6154	6302	6365	6471	6619	6745	6893	7738

sku	frame finish	run-off top species	wood top finish
	6 polished aluminum standard, OR specify powder coat, upcharge \$200 3 matte black powder coat W satin white powder coat	C oak 9 walnut	see seating finishes

luca 8P16R

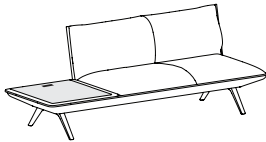

Power
Two-seat armless module with end table
Right side facing
Polished aluminum or powder coat legs
Upholstered

End table available in all oak and walnut finishes. When specifying light finish the natural characteristics of the wood will be visible and color will vary.

Ganging brackets are sold separately and will ship with the product. See Luca accessories page to order brackets.

Power: Surface mount power provides (2) 15 amp receptacles, (1) 2 amp USB-A port, 10 watt and (1) 2 amp USB-C port, 20 watt.

When using a combination of fabrics or leathers, specify the application by designating the appropriate letter, shown below, on the purchase order. Yardage shown must be used.

See terms and conditions for contrasting upholstery upcharges.

- A) One fabric or leather for seat
 yardage: 6.5 yds. leather: 105.0 sq. ft.
- B) One fabric or leather for inside back and outside back
 yardage: 3.0 yds. leather: 50.0 sq. ft.

SCS Indoor Advantage™ Gold and LEVEL® 2 certified. See terms and conditions for additional finish and environmental information.

Seat Height	Arm Height	W	D	H	Fabric	Leather	Weight	Cubes/Qty
16½"	-	86¼"	33¼"	29½"	9.5 yds.	160.0'	198 lbs.	71.85/1
419 mm	-	2191 mm	845 mm	749 mm	8.7 m	14.9 sqm	89.8 kg	2.03 cu.

COM	COL	1	2	3	4	5	6	7	8	9	10	11
5632	5822	6519	6667	6751	6920	7068	7131	7237	7385	7511	7659	8504

sku	frame finish	run-off top species	wood top finish
	6 polished aluminum standard, OR specify powder coat, upcharge \$200 3 matte black powder coat W satin white powder coat	C oak 9 walnut	see seating finishes

luca 8D08N

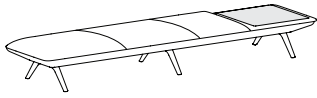

Three-seat bench with end table
Polished aluminum or powder coat legs
Upholstered

End table available in all oak and walnut finishes. When specifying light finish the natural characteristics of the wood will be visible and color will vary.

Ganging brackets are sold separately and will ship with the product. See Luca accessories page to order brackets.

SCS Indoor Advantage™ Gold and LEVEL® 2 certified. See terms and conditions for additional finish and environmental information.

Seat Height	Arm Height	W	D	H	Fabric	Leather	Weight	Cubes/Qty
16½"	-	115¼"	28¾"	16½"	8.5 yds.	140.0'	178 lbs.	50.0'/1
419 mm	-	2921 mm	730 mm	419 mm	7.8 m	13.0 sqm	80.7 kg	1.40 cu.

COM	COL	1	2	3	4	5	6	7	8	9	10	11
3755	3925	4549	4681	4757	4908	5040	5097	5191	5323	5437	5569	6324

luca 8P08N

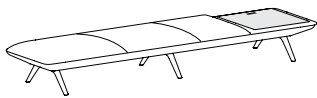

Power
Three-seat bench with end table
Polished aluminum or powder coat legs
Upholstered

End table available in all oak and walnut finishes. When specifying light finish the natural characteristics of the wood will be visible and color will vary.

Ganging brackets are sold separately and will ship with the product. See Luca accessories page to order brackets. .

Power: Surface mount power provides (2) 15 amp receptables, (1) 2 amp USB-A port, 10 watt and (1) 2 amp USB-C port, 20 watt.

SCS Indoor Advantage™ Gold and LEVEL® 2 certified. See terms and conditions for additional finish and environmental information.

Seat Height	Arm Height	W	D	H	Fabric	Leather	Weight	Cubes/Qty
16½"	-	115¼"	28¾"	16½"	8.5 yds.	140.0'	181 lbs.	50.0'/1
419 mm	-	2921 mm	730 mm	419 mm	7.8 m	13.0 sqm	82.1 kg	1.40 cu.

COM	COL	1	2	3	4	5	6	7	8	9	10	11
4519	4689	5313	5445	5521	5672	5804	5861	5955	6087	6201	6333	7088

sku	frame finish	run-off top species	wood top finish
	6 polished aluminum standard, OR specify powder coat, upcharge \$200 3 matte black powder coat W satin white powder coat	C oak 9 walnut	see seating finishes

luca 8D06N

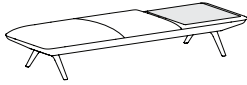

Two-seat bench with end table
Polished aluminum or powder coat legs
Upholstered

End table available in all oak and walnut finishes. When specifying light finish the natural characteristics of the wood will be visible and color will vary.

Ganging brackets are sold separately and will ship with the product. See Luca accessories page to order brackets.

SCS Indoor Advantage™ Gold and LEVEL® 2 certified. See terms and conditions for additional finish and environmental information.

Seat Height	Arm Height	W	D	H	Fabric	Leather	Weight	Cubes/Qty
16½"	-	86¼"	28¾"	16½"	6.75 yds.	110.0'	140 lbs.	37.6'/1
419 mm	-	2191 mm	730 mm	419 mm	6.2 m	10.2 sqm	63.5 kg	1.10 cu.

COM	COL	1	2	3	4	5	6	7	8	9	10	11
3198	3333	3828	3933	3993	4113	4218	4263	4338	4443	4533	4638	5238

luca 8P06N

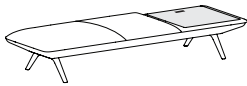

Power
Two-seat bench with end table
Polished aluminum or powder coat legs
Upholstered

End table available in all oak and walnut finishes. When specifying light finish the natural characteristics of the wood will be visible and color will vary.

Ganging brackets are sold separately and will ship with the product. See Luca accessories page to order brackets.

Power: Surface mount power provides (2) 15 amp receptacles, (1) 2 amp USB-A port, 10 watt and (1) 2 amp USB-C port, 20 watt.

SCS Indoor Advantage™ Gold and LEVEL® 2 certified. See terms and conditions for additional finish and environmental information.

Seat Height	Arm Height	W	D	H	Fabric	Leather	Weight	Cubes/Qty
16½"	-	86¼"	28¾"	16½"	6.75 yds.	110.0'	143 lbs.	37.6'/1
419 mm	-	2191 mm	730 mm	419 mm	6.2 m	10.2 sqm	64.9 kg	1.10 cu.

COM	COL	1	2	3	4	5	6	7	8	9	10	11
3963	4098	4593	4698	4758	4878	4983	5028	5103	5208	5298	5403	6003

sku	frame finish	run-off top species	wood top finish
	6 polished aluminum standard, OR specify powder coat, upcharge \$150 3 matte black powder coat W satin white powder coat	C oak 9 walnut	see seating finishes

luca 8D01N



Module bench
Polished aluminum or powder coat legs
Upholstered

Ganging brackets are sold separately and will ship with the product. See Luca accessories page to order brackets.

SCS Indoor Advantage™ Gold and LEVEL® 2 certified. See terms and conditions for additional environmental information.

Seat Height	Arm Height	W	D	H	Fabric	Leather	Weight	Cubes/Qty
16½"	-	45¼"	28¾"	16½"	3.5 yds.	57.0'	78 lbs.	25.67'/1
419 mm	-	1149 mm	730 mm	419 mm	3.2 m	5.3 sqm	35.4 kg	.73 cu.

COM	COL	1	2	3	4	5	6	7	8	9	10	11
1809	1879	2136	2191	2222	2284	2338	2362	2401	2455	2502	2556	2867

luca 8D05N

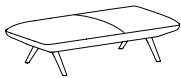

Two-seat module bench
Polished aluminum or powder coat legs
Upholstered

Ganging brackets are sold separately and will ship with the product. See Luca accessories page to order brackets.

SCS Indoor Advantage™ Gold and LEVEL® 2 certified. See terms and conditions for additional environmental information.

Seat Height	Arm Height	W	D	H	Fabric	Leather	Weight	Cubes/Qty
16½"	-	58½"	28¾"	16½"	5 yds.	81.0'	91 lbs.	25.67'/1
419 mm	-	1486 mm	730 mm	419 mm	4.6 m	7.5 sqm	41.3 kg	.73 cu.

COM	COL	1	2	3	4	5	6	7	8	9	10	11
2225	2325	2692	2770	2814	2903	2981	3014	3070	3148	3214	3292	3737

sku

--	--	--	--	--	--	--	--	--	--	--	--	--

frame finish

- 6** polished aluminum standard, OR
- specify powder coat, upcharge \$150
- 3** matte black powder coat
- W** satin white powder coat

--

luca 8D07N

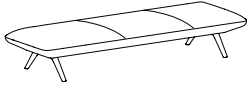

Three-seat module bench
Polished aluminum or powder coat legs
Upholstered

Ganging brackets are sold separately and will ship with the product. See Luca accessories page to order brackets.

SCS Indoor Advantage™ Gold and LEVEL® 2 certified. See terms and conditions for additional environmental information.

Seat Height	Arm Height	W	D	H	Fabric	Leather	Weight	Cubes/Qty
16½"	-	87¼"	28¾"	16½"	7.25 yds.	118.0'	121 lbs	37.6'/1
419 mm	-	2216 mm	730 mm	419 mm	6.6 m	11.0 sqm	54.9 kg	1.10 cu.

COM	COL	1	2	3	4	5	6	7	8	9	10	11
2642	2787	3319	3432	3496	3625	3738	3786	3867	3980	4076	4189	4834

luca 8D02N

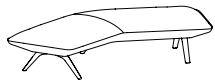

45° Modular bench
Polished aluminum or powder coat legs
Upholstered

Ganging brackets are sold separately and will ship with the product. See Luca accessories page to order brackets.

SCS Indoor Advantage™ Gold and LEVEL® 2 certified. See terms and conditions for additional environmental information.

Seat Height	Arm Height	W	D	H	Fabric	Leather	Weight	Cubes/Qty
16½"	-	80½"	40¼"	16½"	4.75 yds.	78.0'	119 lbs.	45.45'/1
419 mm	-	2045 mm	1022 mm	419 mm	4.3 m	7.2 sqm	54.0 kg	1.30 cu.

COM	COL	1	2	3	4	5	6	7	8	9	10	11
2642	2737	3086	3160	3202	3286	3360	3392	3445	3519	3582	3656	4078

sku

--	--	--	--	--	--	--	--	--	--	--	--	--

frame finish

- 6** polished aluminum standard, OR
- specify powder coat, upcharge \$150
- 3** matte black powder coat
- W** satin white powder coat

luca 8D09N

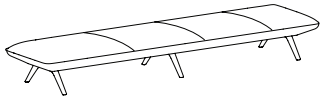

Four-seat module bench
Polished aluminum or powder coat legs
Upholstered

Ganging brackets are sold separately and will ship with product. See Luca accessories page to order brackets

SCS Indoor Advantage™ Gold and LEVEL® 2 certified. See terms and conditions for additional environmental information.

Seat Height	Arm Height	W	D	H	Fabric	Leather	Weight	Cubes/Qty
16½"	-	117"	28¾"	16½"	9.5 yds.	154.0'	159 lbs.	50.0'/1
419 mm	-	2972 mm	730 mm	419 mm	8.7 m	14.3 sqm	72.1 kg	1.40 cu.

COM	COL	1	2	3	4	5	6	7	8	9	10	11
3338	3528	4225	4373	4457	4626	4774	4837	4943	5091	5217	5365	6210

luca 8D32N

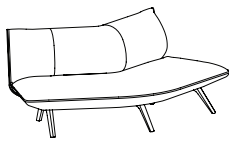

Outside 45° corner module
Armless
Polished aluminum or powder coat legs
Upholstered

Ganging brackets are sold separately and will ship with the product. See Luca accessories page to order brackets.

When using a combination of fabrics or leathers, specify the application by designating the appropriate letter, shown below, on the purchase order. Yardage shown must be used.

See terms and conditions for contrasting upholstery upcharges.

- A) One fabric or leather for seat
yardage: 5.5 yds. leather: 90.0 sq. ft.
- B) One fabric or leather for inside back and outside back
yardage: 5.25 yds. leather: 85.0 sq. ft.

SCS Indoor Advantage™ Gold and LEVEL® 2 certified. See terms and conditions for additional environmental information.

Seat Height	Arm Height	W	D	H	Fabric	Leather	Weight	Cubes/Qty
16½"	-	81¼"	44½"	29½"	9.25 yds.	150.0'	160 lbs.	84.29'/1
419 mm	-	2064 mm	1130 mm	749 mm	8.5 m	13.0 sqm	72.6 kg	2.40 cu.

COM	COL	1	2	3	4	5	6	7	8	9	10	11
4866	5051	5730	5874	5956	6120	6264	6326	6429	6573	6696	6840	7662

sku

frame finish

--	--	--	--	--	--	--	--	--	--	--	--	--

- 6** polished aluminum standard, OR
- specify powder coat, upcharge \$200
- 3** matte black powder coat
- W** satin white powder coat

luca 8D31N

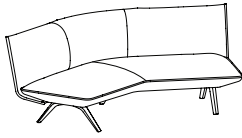

Inside 45° corner module
Armless
Polished aluminum or powder coat legs
Upholstered

Ganging brackets are sold separately and will ship with the product. See Luca accessories page to order brackets.

When using a combination of fabrics or leathers, specify the application by designating the appropriate letter, shown below, on the purchase order. Yardage shown must be used.

See terms and conditions for contrasting upholstery upcharges.

- A) One fabric or leather for seat
 yardage: 5.5 yds. leather: 90.0 sq. ft.
- B) One fabric or leather for inside back and outside back
 yardage: 7.25 yds. leather: 118.0 sq. ft.

SCS Indoor Advantage™ Gold and LEVEL® 2 certified. See terms and conditions for additional environmental information.

Seat Height	Arm Height	W	D	H	Fabric	Leather	Weight	Cubes/Qty
16½"	-	85"	44½"	29½"	11.75 yds.	190.0'	197 lbs.	84.29/1
419 mm	-	2159 mm	1130 mm	749 mm	10.7 m	17.6 sqm	89.4 kg	2.40 cu.

COM	COL	1	2	3	4	5	6	7	8	9	10	11
5561	5796	6658	6841	6945	7154	7337	7415	7546	7729	7885	8068	9113

luca 8D33L

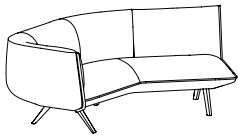

Inside 45° corner module
Left arm facing
Polished aluminum or powder coat legs
Upholstered

Ganging brackets are sold separately and will ship with the product. See Luca accessories page to order brackets.

When using a combination of fabrics or leathers, specify the application by designating the appropriate letter, shown below, on the purchase order. Yardage shown must be used.

See terms and conditions for contrasting upholstery upcharges.

- A) One fabric or leather for seat
 yardage: 5.0 yds. leather: 82.0 sq. ft.
- B) One fabric or leather for inside back and outside back, outer shell and inside arms
 yardage: 8.5 yds. leather: 140.0 sq. ft.

SCS Indoor Advantage™ Gold and LEVEL® 2 certified. See terms and conditions for additional environmental information.

Seat Height	Arm Height	W	D	H	Fabric	Leather	Weight	Cubes/Qty
16½"	29½"	86¼"	44½"	29½"	13.25 yds.	215.0'	199 lbs.	84.29/1
419 mm	749 mm	2191 mm	1130 mm	749 mm	12.1 m	20.0 sqm	90.3 kg	2.40 cu.

COM	COL	1	2	3	4	5	6	7	8	9	10	11
6117	6382	7354	7560	7678	7914	8120	8208	8355	8561	8738	8944	10122

sku

frame finish

--	--	--	--	--	--

- 6** polished aluminum standard, OR
 specify powder coat, upcharge \$200
- 3** matte black powder coat
- W** satin white powder coat

luca 8D33R

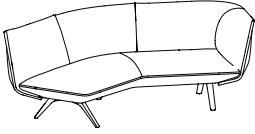

Inside 45° corner module
Right arm facing
Polished aluminum or powder coat legs
Upholstered

Ganging brackets are sold separately and will ship with the product. See Luca accessories page to order brackets.

When using a combination of fabrics or leathers, specify the application by designating the appropriate letter, shown below, on the purchase order. Yardage shown must be used.

See terms and conditions for contrasting upholstery upcharges.

- A) One fabric or leather for seat
 yardage: 5.0 yds. leather: 82.0 sq. ft.
- B) One fabric or leather for inside back and outside back, outer shell and inside arm
 yardage: 8.5 yds. leather: 140.0 sq. ft.

SCS Indoor Advantage™ Gold and LEVEL® 2 certified. See terms and conditions for additional environmental information.

Seat Height	Arm Height	W	D	H	Fabric	Leather	Weight	Cubes/Qty
16½"	29½"	86¼"	44½"	29½"	13.25 yds.	215.0'	199 lbs.	84.29/1
419 mm	749 mm	2191 mm	1130 mm	749 mm	12.1 m	20.0 sqm	90.3 kg	2.40 cu.

COM	COL	1	2	3	4	5	6	7	8	9	10	11
6117	6382	7354	7560	7678	7914	8120	8208	8355	8561	8738	8944	10122

sku	frame finish				
<table border="1" style="width: 100%; height: 100%;"> <tr> <td style="width: 25%; height: 15px;"> </td> <td style="width: 25%; height: 15px;"> </td> <td style="width: 25%; height: 15px;"> </td> <td style="width: 25%; height: 15px;"> </td> </tr> </table>					<p>6 polished aluminum standard, OR</p> <p style="color: red;">specify powder coat, upcharge \$200</p> <p>3 matte black powder coat</p> <p>W satin white powder coat</p>

description	sku	w	d	h	price
 <p>ganging bracket Order one ganging bracket per point of connection of modular units. Ganging brackets are sold separately and will ship with product.</p>	111	14½	9½	3½	\$ 108

series

sku

8 | D |

1 | 1 | 1 |