

mirador 8040A



Bench
Polished aluminum frame
Upholstered

Levelers and non-marring glides

SCS Indoor Advantage™ Gold and LEVEL® 2 certified. See terms and conditions for additional environmental information.

Seat Height	Arm Height	W	D	H	Fabric	Leather	Weight	Cubes/Qty
16½"	-	30"	28¾"	16½"	3.0 yds	40.0'	55 lbs	22.67'/1
419 mm	-	762 mm	730 mm	419 mm	2.7 m	3.7 sqm	25.0 kg	.64 cu

COM	COL	1	2	3	4	5	6	7	8	9	10	11
1606	1666	1886	1933	1960	2013	2060	2080	2113	2160	2200	2246	2513

mirador 8041A

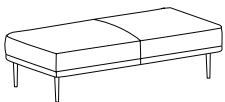

Two-seat bench
Polished aluminum frame
Upholstered

Levelers and non-marring glides

SCS Indoor Advantage™ Gold and LEVEL® 2 certified. See terms and conditions for additional environmental information.

Seat Height	Arm Height	W	D	H	Fabric	Leather	Weight	Cubes/Qty
16½"	-	60"	28¾"	16½"	5.5 yds	75.0'	122 lbs	68.33'/1
419 mm	-	1524 mm	730 mm	419 mm	5.0 m	7.0 sqm	55.5 kg	1.93 cu

COM	COL	1	2	3	4	5	6	7	8	9	10	11
2493	2603	3007	3092	3141	3239	3325	3361	3422	3508	3581	3667	4156

mirador 8042A

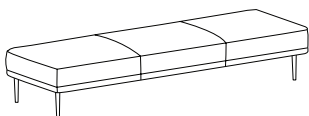

Three-seat bench
Polished aluminum frame
Upholstered

Levelers and non-marring glides

SCS Indoor Advantage™ Gold and LEVEL® 2 certified. See terms and conditions for additional environmental information.

Seat Height	Arm Height	W	D	H	Fabric	Leather	Weight	Cubes/Qty
16½"	-	90"	28¾"	16½"	7.5 yds	101.0'	181 lbs	101.65'/1
419 mm	-	2286 mm	730 mm	419 mm	6.9 m	9.4 sqm	82.3 kg	2.87 cu

COM	COL	1	2	3	4	5	6	7	8	9	10	11
2670	2820	3370	3487	3554	3687	3804	3854	3937	4054	4154	4270	4937

Mirador Seating System Specification Guide

Mirador is a modular seating product comprised of 63 unique modules, which may be used interchangeably to create an unlimited number of configurations. To select the modules that are appropriate for your application use the four steps listed below.

Please visit BernhardtDesign.com for a complete library of 2D and 3D models. You may also contact your local sales representative or the Bernhardt Design corporate office for specification assistance. Mirador is fully upholstered with a polished cast aluminum frame with levelers and non-marring glides.

When ordering multi-item configurations, please provide the total COM yardage from the same dye lot in a continuous roll(s). *All COM/COL fabrics must be preapproved by Bernhardt Design prior to application. See terms and conditions for instructions on tagging COM. Specify fabric railroaded when used with Item 5905 corner module.

All necessary ganging brackets are included and pre-installed. SCS Indoor Advantage™ Gold and LEVEL® 2 certified. See terms and conditions for additional environmental information.

Four Step Selection Process

Step 1 - Front Selection

Sofa and Settee modules are available with two different front conditions.

A - Flared Fronts

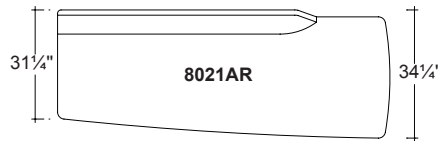
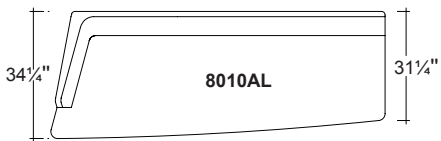

B - Non-Flared Fronts

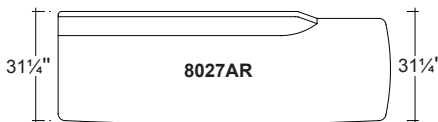
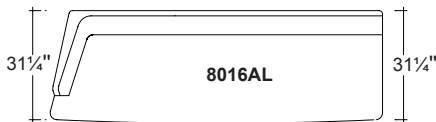

Step 2 - Arm Selection

Sofa and Settee modules are available with arms or without arms.

A - Arm Module

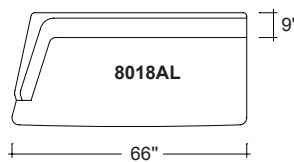
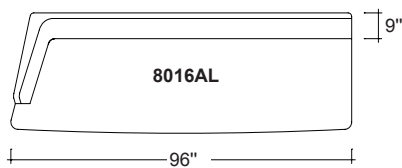

B - Armless Module

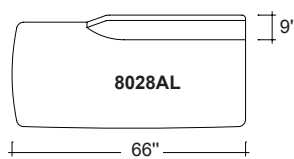
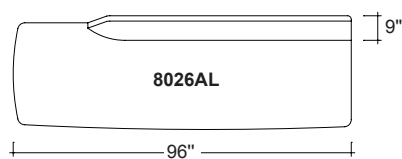

Mirador Seating System Specification Guide

Step 3 - End Selection

Sofa and Settee modules are available with three unique end conditions. The selection of an end condition is used to achieve different angles when connecting multiple modules.

A - Straight Ends are specified for creating a configuration in a straight line 180°.

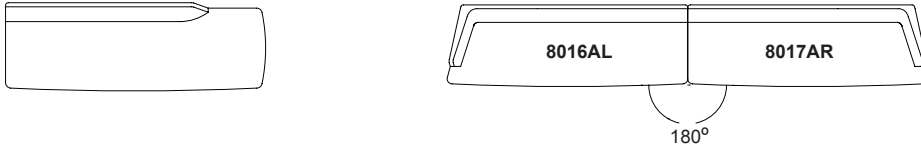

B - Open Angle Ends are specified for opening up a configuration and achieving an angle which is greater than 180°.

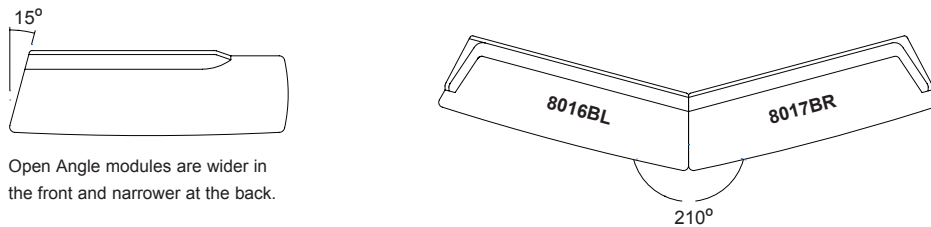

Open Angle modules are wider in the front and narrower at the back.

C - Closed Angle Ends are specified for closing up a configuration and achieving an angle which is less than 180°.

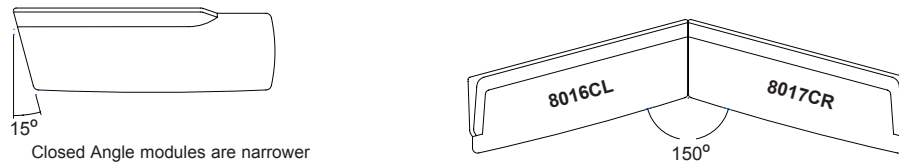

Closed Angle modules are narrower in the front and wider at the back.

Modules with different end conditions may be connected to achieve the appropriate angle.

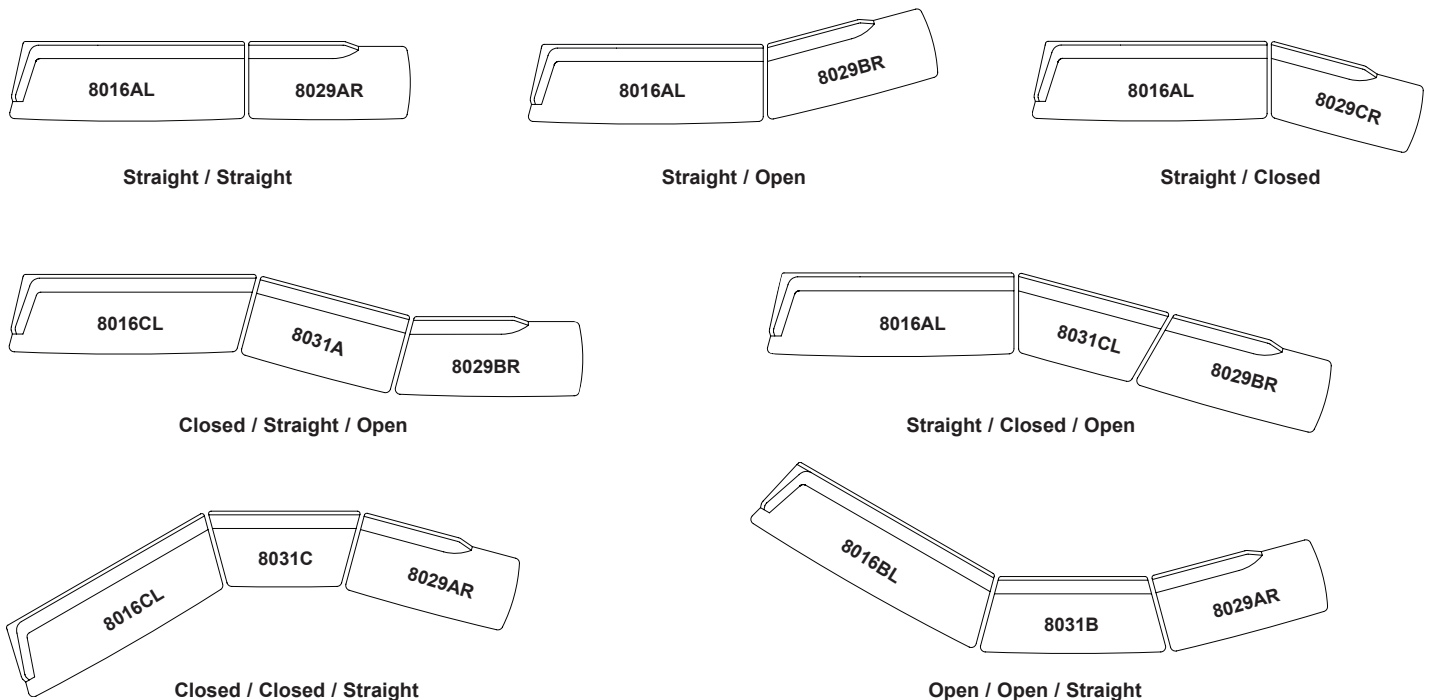

Mirador Seating System Specification Guide

Step 4 - Connecting Module Selection

A - Specifying connecting modules to achieve a desired length.

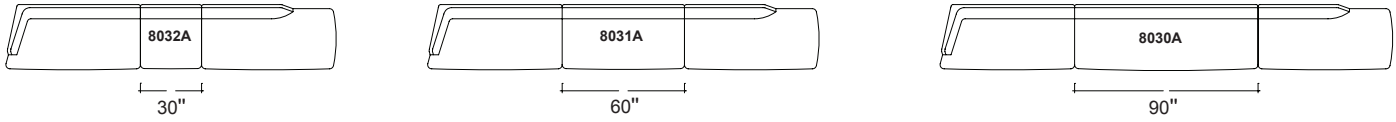

B - Specifying connection modules to achieve a desired angle.

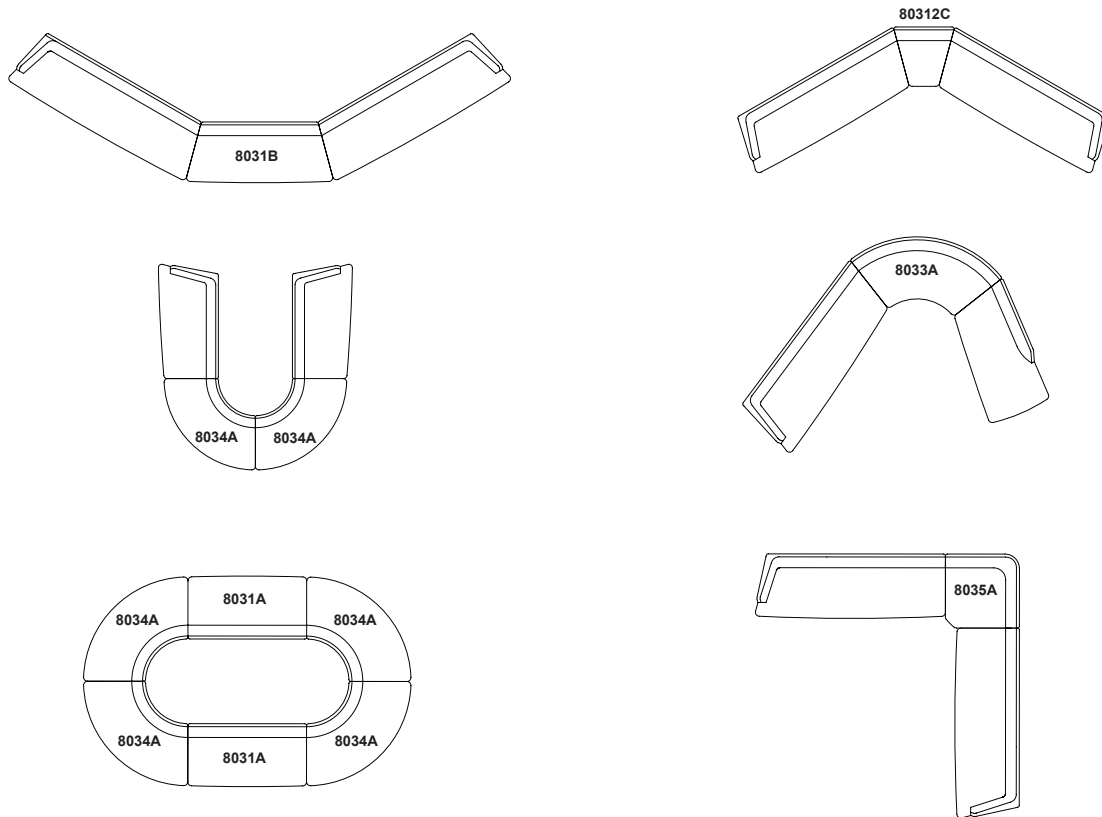

Twelve unique connecting modules are available to alter both the length and the angle of a configuration.

Straight Connecting Modules



Open Angle Connecting Modules



Closed Angle Connecting Modules



Mirador Seating System Sample Configurations

		Sku	Description
1		8028AL 8029AR	Left Armless Right Armless
2		8010AL 8011AR	Left Arm Right Arm
3		8012CL 8021CR	Left Arm Right Armless
4		8026BL 8033A 8027BR	Left Armless Inside Quarter Round Right Armless
5		8016BL 8031B 8017BR	Left Arm Connecting Module Right Arm

Mirador Seating System Sample Configurations

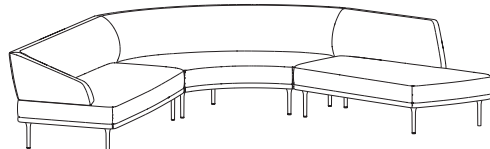
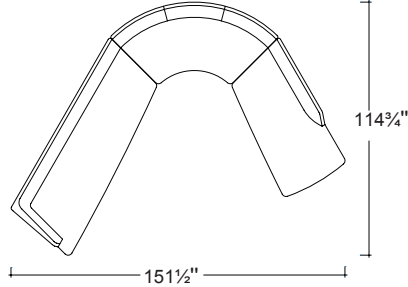
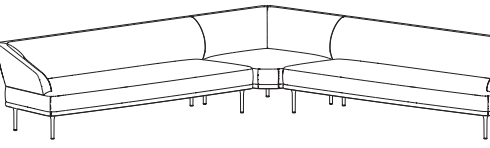
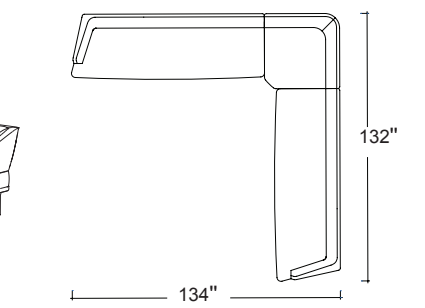
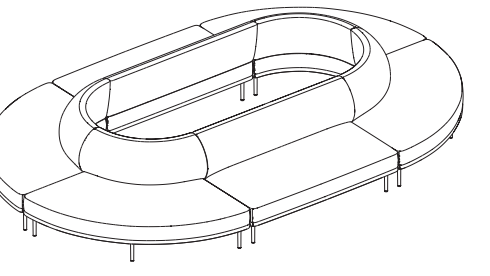
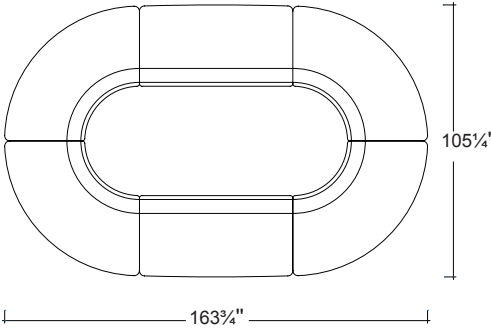
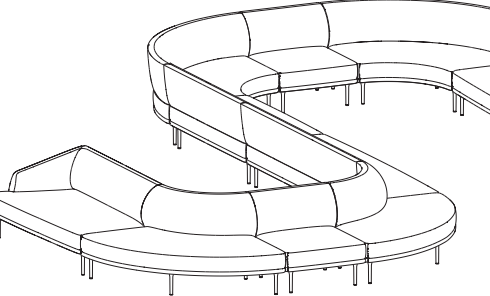
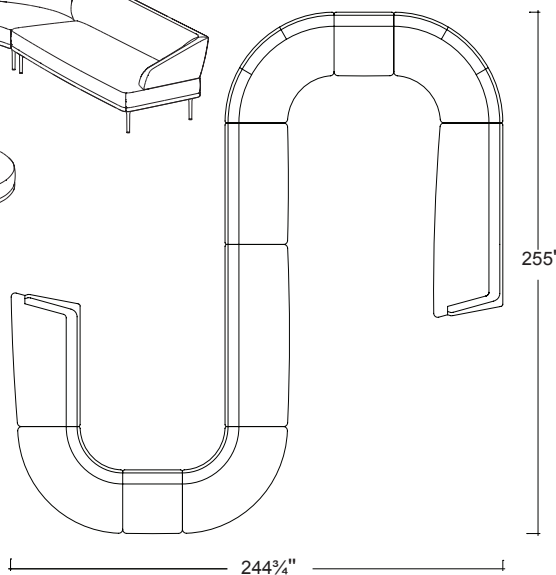
6	Sku	Description
	<p>8010CL 8033A 8023CR</p>	<p>Left Arm Inside Quarter Round Right Armless</p>
		
7	<p>8016AL 8035A 8017AR</p>	<p>Left Arm Corner Right Arm</p>
		
8	<p>8034A 8031A</p>	<p>Outside Quarter Round (4) Connecting Module (2)</p>
		
9	<p>8011AR 8033A 8032A 8031A 8030A 8034A 8012AL</p>	<p>Right Arm Inside Quarter Round (2) Connecting One-Seat (2) Connecting Two-Seat Connecting Three-Seat Outside Quarter Round (2) Left Arm</p>
		

Mirador Seating System Product Overview

Flared Front Sofa and Settee

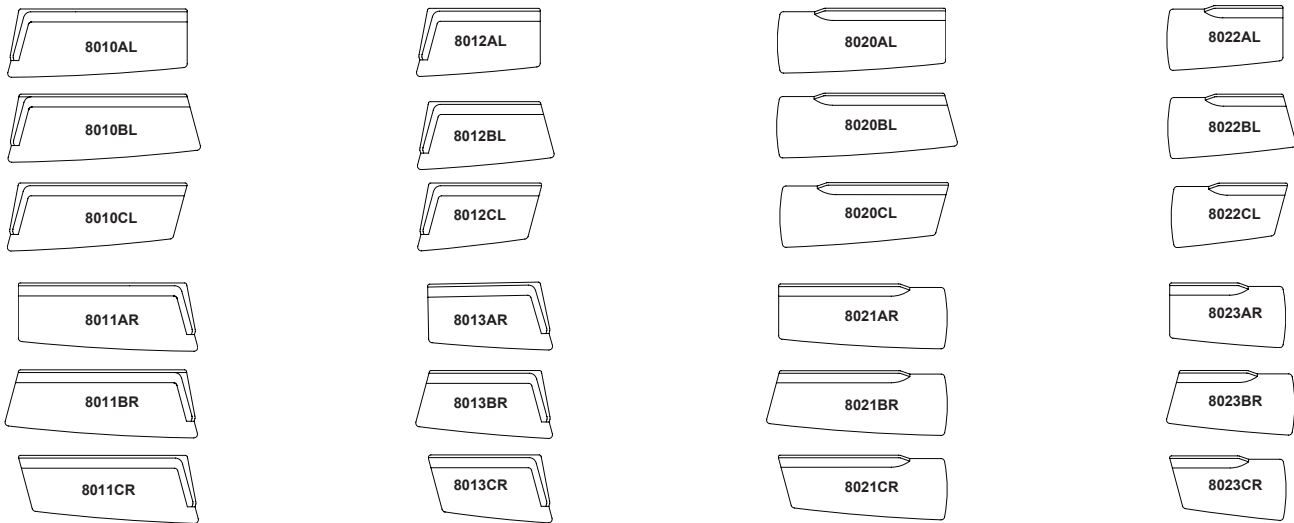

Non-Flared Front Sofa and Settee

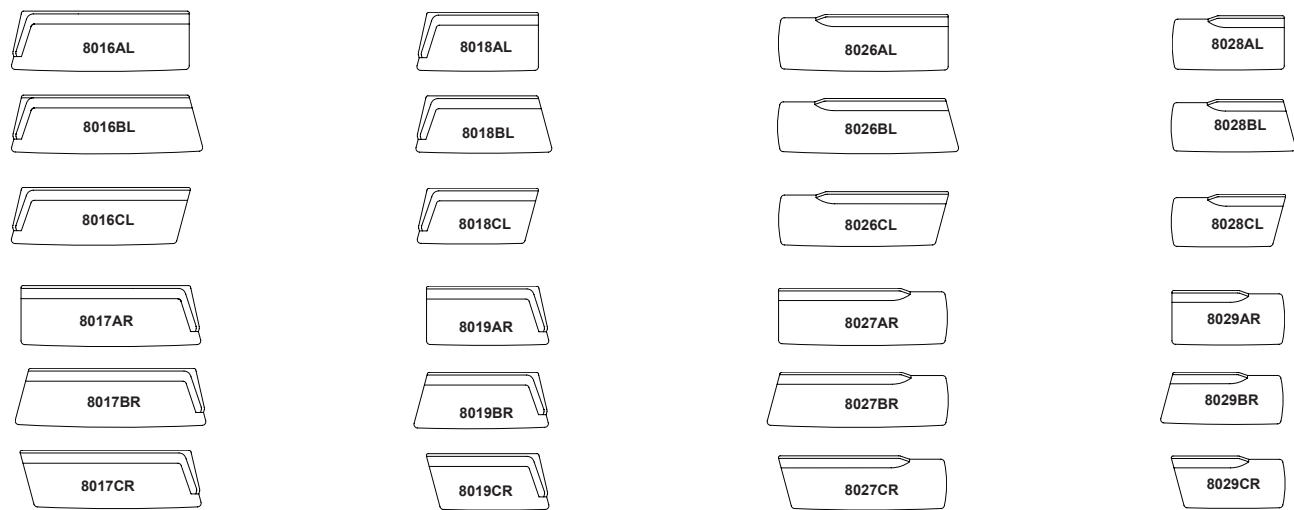

Connecting Module



Freestanding Bench

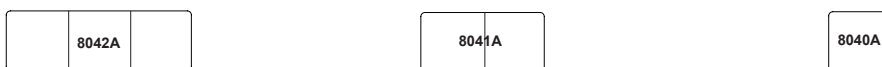



mirador 8010AL

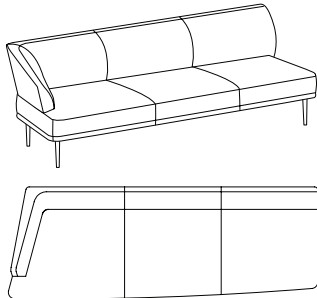

Three-seat module
Left arm facing
Straight end
Polished aluminum base
Upholstered

All necessary ganging brackets are included and pre-installed

When using a combination of fabrics or leathers, specify the application by designating the appropriate letter, shown below, on the purchase order. Yardage shown must be used.

See terms and conditions for contrasting upholstery upcharges.

- A) One fabric or leather for seat cushion
 yardage: 7.5 yds. leather: 122.0 sq. ft.
- B) One fabric or leather for inside back, outside back and side arm
 yardage: 5.75 yds. leather: 95.0 sq. ft.

SCS Indoor Advantage™ Gold and LEVEL® 2 certified. See terms and conditions for additional environmental information.

Seat Height	Arm Height	W	D	H	Fabric	Leather	Weight	Cubes/Qty
16½"	21½"-29"	96"	31¼"-34¼"	29"	11.25 yds.	160.0'	221 lbs.	101.65'/1
419 mm	546-737 mm	2438 mm	794-870 mm	737 mm	10.3 m	14.9 sqm	100.5 kg	2.88 cu.

COM	COL	1	2	3	4	5	6	7	8	9	10	11
6219	6444	7269	7444	7544	7744	7919	7994	8119	8294	8444	8619	9619

mirador 8010BL

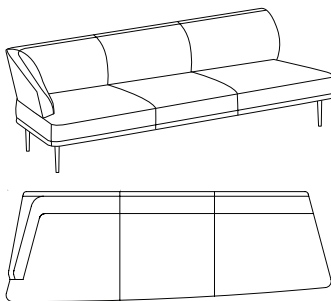

Three-seat module
Left arm facing
Open angle end
Polished aluminum base
Upholstered

All necessary ganging brackets are included and pre-installed

When using a combination of fabrics or leathers, specify the application by designating the appropriate letter, shown below, on the purchase order. Yardage shown must be used.

See terms and conditions for contrasting upholstery upcharges.

- A) One fabric or leather for seat cushion
 yardage: 7.5 yds. leather: 122.0 sq. ft.
- B) One fabric or leather for inside back, outside back and side arm
 yardage: 5.75 yds. leather: 95.0 sq. ft.

SCS Indoor Advantage™ Gold and LEVEL® 2 certified. See terms and conditions for additional environmental information.

Seat Height	Arm Height	W	D	H	Fabric	Leather	Weight	Cubes/Qty
16½"	21½"-29"	103"	31¼"-34¼"	29"	11.25 yds.	160.0'	221 lbs.	97.97'/1
419 mm	546-737 mm	2616 mm	794-870 mm	737 mm	10.3 m	14.9 sqm	100.5 kg	2.78 cu.

COM	COL	1	2	3	4	5	6	7	8	9	10	11
6219	6444	7269	7444	7544	7744	7919	7994	8119	8294	8444	8619	9619

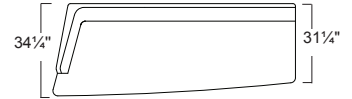

mirador 8010CL

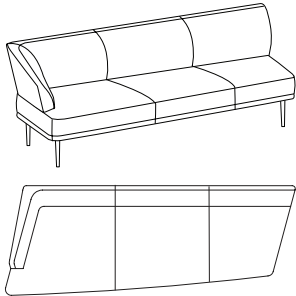

Three-seat module
Left arm facing
Closed angle end
Polished aluminum base
Upholstered

All necessary ganging brackets are included and pre-installed

When using a combination of fabrics or leathers, specify the application by designating the appropriate letter, shown below, on the purchase order. Yardage shown must be used.

See terms and conditions for contrasting upholstery upcharges.

- A) One fabric or leather for seat cushion
 yardage: 7.5 yds. leather: 122.0 sq. ft.
- B) One fabric or leather for inside back, outside back and side arm
 yardage: 5.75 yds. leather: 95.0 sq. ft.

SCS Indoor Advantage™ Gold and LEVEL® 2 certified. See terms and conditions for additional environmental information.

Seat Height	Arm Height	W	D	H	Fabric	Leather	Weight	Cubes/Qty
16½"	21½"-29"	96"	31¼"-34¼"	29"	11.25 yds.	160.0'	224 lbs.	97.97'/1
419 mm	546-737 mm	2438 mm	794-870 mm	737 mm	10.3 m	14.9 sqm	101.8 kg	97.97'/1

COM	COL	1	2	3	4	5	6	7	8	9	10	11
6219	6444	7269	7444	7544	7744	7919	7994	8119	8294	8444	8619	9619

mirador 8011AR

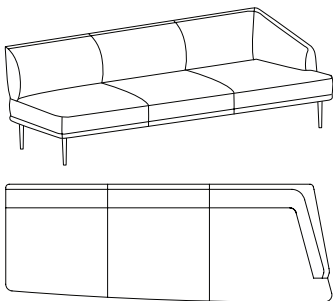

Three-seat module
Right arm facing
Straight end
Polished aluminum base
Upholstered

All necessary ganging brackets are included and pre-installed

When using a combination of fabrics or leathers, specify the application by designating the appropriate letter, shown below, on the purchase order. Yardage shown must be used.

See terms and conditions for contrasting upholstery upcharges.

- A) One fabric or leather for seat cushion
 yardage: 7.5 yds. leather: 122.0 sq. ft.
- B) One fabric or leather for inside back, outside back and side arm
 yardage: 5.75 yds. leather: 95.0 sq. ft.

SCS Indoor Advantage™ Gold and LEVEL® 2 certified. See terms and conditions for additional environmental information.

Seat Height	Arm Height	W	D	H	Fabric	Leather	Weight	Cubes/Qty
16½"	21½"-29"	96"	31¼"-34¼"	29"	11.25 yds.	160.0'	221 lbs.	101.65'/1
419 mm	546-737 mm	2438 mm	794-870 mm	737 mm	10.3 m	14.9 sqm	100.5 kg	2.88 cu.

COM	COL	1	2	3	4	5	6	7	8	9	10	11
6219	6444	7269	7444	7544	7744	7919	7994	8119	8294	8444	8619	9619

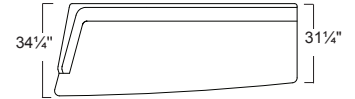

mirador 8011BR

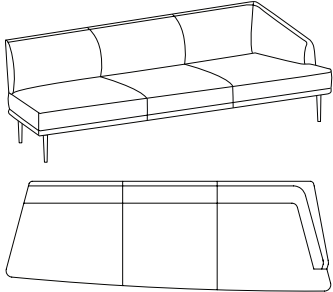

Three-seat module
Right arm facing
Open angle end
Polished aluminum base
Upholstered

All necessary ganging brackets are included and pre-installed

When using a combination of fabrics or leathers, specify the application by designating the appropriate letter, shown below, on the purchase order. Yardage shown must be used.

See terms and conditions for contrasting upholstery upcharges.

- A) One fabric or leather for seat cushion
 yardage: 7.5 yds. leather: 122.0 sq. ft.
- B) One fabric or leather for inside back, outside back and side arm
 yardage: 5.75 yds. leather: 95.0 sq. ft.

SCS Indoor Advantage™ Gold and LEVEL® 2 certified. See terms and conditions for additional environmental information.

Seat Height	Arm Height	W	D	H	Fabric	Leather	Weight	Cubes/Qty
16½"	21½ -29"	103"	31¼ -34¼"	29"	11.25 yds.	160.0'	224 lbs.	97.97'/1
419 mm	546-737 mm	2616 mm	794-870 mm	737 mm	10.3 m	14.9 sqm	101.8 kg	2.77 cu.

COM	COL	1	2	3	4	5	6	7	8	9	10	11
6219	6444	7269	7444	7544	7744	7919	7994	8119	8294	8444	8619	9619

mirador 8011CR

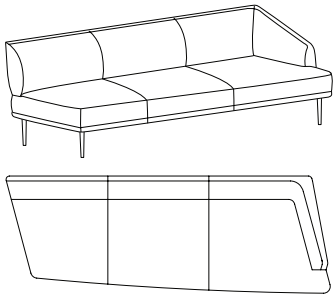

Three-seat module
Right arm facing
Closed angle end
Polished aluminum base
Upholstered

All necessary ganging brackets are included and pre-installed

When using a combination of fabrics or leathers, specify the application by designating the appropriate letter, shown below, on the purchase order. Yardage shown must be used.

See terms and conditions for contrasting upholstery upcharges.

- A) One fabric or leather for seat cushion
 yardage: 7.5 yds. leather: 122.0 sq. ft.
- B) One fabric or leather for inside back, outside back and side arm
 yardage: 5.75 yds. leather: 95.0 sq. ft.

SCS Indoor Advantage™ Gold and LEVEL® 2 certified. See terms and conditions for additional environmental information.

Seat Height	Arm Height	W	D	H	Fabric	Leather	Weight	Cubes/Qty
16½"	21½ -29"	96"	31¼ -34¼"	29"	11.25 yds.	160.0'	221 lbs.	101.65'/1
419 mm	546-737 mm	2438 mm	794-870 mm	737 mm	10.3 m	14.9 sqm	100.5 kg	2.88 cu.

COM	COL	1	2	3	4	5	6	7	8	9	10	11
6219	6444	7269	7444	7544	7744	7919	7994	8119	8294	8444	8619	9619



mirador 8012AL

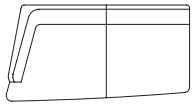

Two-seat module
Left arm facing
Straight end
Polished aluminum base
Upholstered

All necessary ganging brackets are included and pre-installed

When using a combination of fabrics or leathers, specify the application by designating the appropriate letter, shown below, on the purchase order. Yardage shown must be used.

See terms and conditions for contrasting upholstery upcharges.

- A) One fabric or leather for seat cushion
 yardage: 5.5 yds. leather: 90.0 sq. ft.
- B) One fabric or leather for inside back, outside back and side arm
 yardage: 4.25 yds. leather: 70.0 sq. ft.

SCS Indoor Advantage™ Gold and LEVEL® 2 certified. See terms and conditions for additional environmental information.

Seat Height	Arm Height	W	D	H	Fabric	Leather	Weight	Cubes/Qty
16½"	21½"-29"	66"	31¼"-34¼"	29"	8.5 yds.	144.0'	152 lbs.	68.33'/1
419 mm	546-737 mm	1676 mm	794-870 mm	737 mm	7.8 m	13.4 sqm	69.1 kg	1.93 cu.

COM	COL	1	2	3	4	5	6	7	8	9	10	11
4978	5148	5772	5904	5980	6131	6263	6320	6414	6546	6660	6792	7547

mirador 8012BL

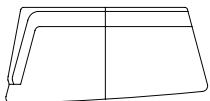
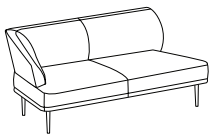

Two-seat module
Left arm facing
Open angle end
Polished aluminum base
Upholstered

All necessary ganging brackets are included and pre-installed

When using a combination of fabrics or leathers, specify the application by designating the appropriate letter, shown below, on the purchase order. Yardage shown must be used.

See terms and conditions for contrasting upholstery upcharges.

- A) One fabric or leather for seat cushion
 yardage: 5.5 yds. leather: 90.0 sq. ft.
- B) One fabric or leather for inside back, outside back and side arm
 yardage: 4.25 yds. leather: 70.0 sq. ft.

SCS Indoor Advantage™ Gold and LEVEL® 2 certified. See terms and conditions for additional environmental information.

Seat Height	Arm Height	W	D	H	Fabric	Leather	Weight	Cubes/Qty
16½"	21½"-29"	73"	31¼"-34¼"	29"	8.5 yds.	144.0'	155 lbs.	80.67'/1
419 mm	21½"-29"	1854 mm	794-870 mm	737 mm	7.8 m	13.4 sqm	70.5 kg	2.28 cu.

COM	COL	1	2	3	4	5	6	7	8	9	10	11
4978	5148	5772	5904	5980	6131	6263	6320	6414	6546	6660	6792	7547

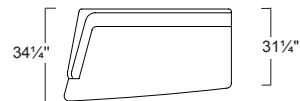

mirador 8012CL

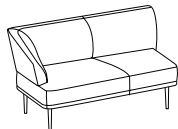

Two-seat module
Left arm facing
Closed angle end
Polished aluminum base
Upholstered

All necessary ganging brackets are included and pre-installed

When using a combination of fabrics or leathers, specify the application by designating the appropriate letter, shown below, on the purchase order. Yardage shown must be used.

See terms and conditions for contrasting upholstery upcharges.

- A) One fabric or leather for seat cushion
 yardage: 5.5 yds. leather: 90.0 sq. ft.
- B) One fabric or leather for inside back, outside back and side arm
 yardage: 4.25 yds. leather: 70.0 sq. ft.

SCS Indoor Advantage™ Gold and LEVEL® 2 certified. See terms and conditions for additional environmental information.

Seat Height	Arm Height	W	D	H	Fabric	Leather	Weight	Cubes/Qty
16½"	21½ -29"	66"	31¼ -34¼"	29"	8.5 yds.	144.0'	152 lbs.	68.33'/1
419 mm	546-737 mm	1676 mm	794-870 mm	737 mm	7.8 m	13.4 sqm	69.1 kg	1.93 cu.

COM	COL	1	2	3	4	5	6	7	8	9	10	11
4978	5148	5772	5904	5980	6131	6263	6320	6414	6546	6660	6792	7547

mirador 8013AR

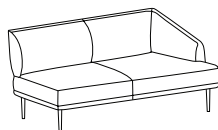

Two-seat module
Right arm facing
Straight end
Polished aluminum base
Upholstered

All necessary ganging brackets are included and pre-installed

When using a combination of fabrics or leathers, specify the application by designating the appropriate letter, shown below, on the purchase order. Yardage shown must be used.

See terms and conditions for contrasting upholstery upcharges.

- A) One fabric or leather for seat cushion
 yardage: 5.5 yds. leather: 90.0 sq. ft.
- B) One fabric or leather for inside back, outside back and side arm
 yardage: 4.25 yds. leather: 70.0 sq. ft.

SCS Indoor Advantage™ Gold and LEVEL® 2 certified. See terms and conditions for additional environmental information.

Seat Height	Arm Height	W	D	H	Fabric	Leather	Weight	Cubes/Qty
16½"	21½ -29"	66"	31¼ -34¼"	29"	8.5 yds.	144.0'	152 lbs.	68.33'/1
419 mm	546-737 mm	1676 mm	794-870 mm	737 mm	7.8 m	13.4 sqm	69.1 kg	1.93 cu.

COM	COL	1	2	3	4	5	6	7	8	9	10	11
4978	5148	5772	5904	5980	6131	6263	6320	6414	6546	6660	6792	7547



mirador 8013BR

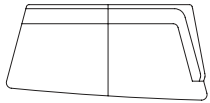
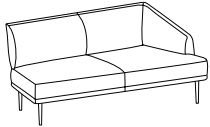

Two-seat module
Right arm facing
Open angle end
Polished aluminum base
Upholstered

All necessary ganging brackets are included and pre-installed

When using a combination of fabrics or leathers, specify the application by designating the appropriate letter, shown below, on the purchase order. Yardage shown must be used.

See terms and conditions for contrasting upholstery upcharges.

- A) One fabric or leather for seat cushion
 yardage: 5.5 yds. leather: 90.0 sq. ft.
- B) One fabric or leather for inside back, outside back and side arm
 yardage: 4.25 yds. leather: 70.0 sq. ft.

SCS Indoor Advantage™ Gold and LEVEL® 2 certified. See terms and conditions for additional environmental information.

Seat Height	Arm Height	W	D	H	Fabric	Leather	Weight	Cubes/Qty
16½"	21½"-29"	73"	31¼"-34¼"	29"	8.5 yds.	144.0'	155 lbs.	80.67'/1
419 mm	546-737 mm	1854 mm	794-870 mm	737 mm	7.8 m	13.4 sqm	70.5 kg	2.28 cu.

COM	COL	1	2	3	4	5	6	7	8	9	10	11
4978	5148	5772	5904	5980	6131	6263	6320	6414	6546	6660	6792	7547

mirador 8013CR

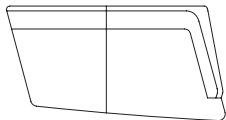
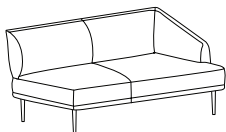

Two-seat module
Right arm facing
Closed angle end
Polished aluminum base
Upholstered

All necessary ganging brackets are included and pre-installed

When using a combination of fabrics or leathers, specify the application by designating the appropriate letter, shown below, on the purchase order. Yardage shown must be used.

See terms and conditions for contrasting upholstery upcharges.

- A) One fabric or leather for seat cushion
 yardage: 5.5 yds. leather: 90.0sq. ft.
- B) One fabric or leather for inside back, outside back and side arm
 yardage: 4.25 yds. leather: 70.0 sq. ft.

SCS Indoor Advantage™ Gold and LEVEL® 2 certified. See terms and conditions for additional environmental information.

Seat Height	Arm Height	W	D	H	Fabric	Leather	Weight	Cubes/Qty
16½"	21½"-29"	66"	31¼"-34¼"	29"	8.5 yds.	144.0'	152 lbs.	68.33'/1
419 mm	546-737 mm	1676 mm	794-870 mm	737 mm	7.8 m	13.4 sqm	69.1 kg	1.93 cu.

COM	COL	1	2	3	4	5	6	7	8	9	10	11
4978	5148	5772	5904	5980	6131	6263	6320	6414	6546	6660	6792	7547

flared front sofa - armless



mirador 8020AL

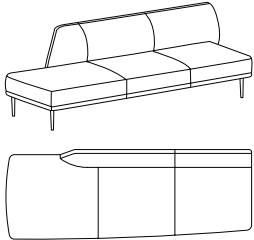

Three-seat armless module
Straight end
Polished aluminum base
Upholstered

All necessary ganging brackets are included and pre-installed

When using a combination of fabrics or leathers, specify the application by designating the appropriate letter, shown below, on the purchase order. Yardage shown must be used.

See terms and conditions for contrasting upholstery upcharges.

- A) One fabric or leather for seat cushion
yardage: 7.5 yds. leather: 122.0 sq. ft.
- B) One fabric or leather for inside back and outside back
yardage: 4.5 yds. leather: 73.0 sq. ft.

SCS Indoor Advantage™ Gold and LEVEL® 2 certified. See terms and conditions for additional environmental information.

Seat Height	Arm Height	W	D	H	Fabric	Leather	Weight	Cubes/Qty
16½"	-	96"	31¼ -34¼"	29"	10.25 yds.	150.0'	200 lbs.	101.65'/1
419 mm	-	2438 mm	794-870 mm	737 mm	9.4 m	14.0 sqm	90.9 kg	2.87 cu.

COM	COL	1	2	3	4	5	6	7	8	9	10	11
5335	5540	6292	6452	6543	6725	6884	6953	7067	7226	7363	7522	8433

mirador 8020BL

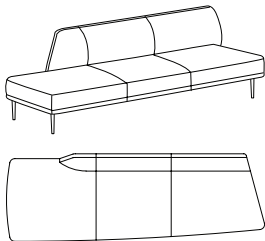

Three-seat armless module
Open angle end
Polished aluminum base
Upholstered

All necessary ganging brackets are included and pre-installed

When using a combination of fabrics or leathers, specify the application by designating the appropriate letter, shown below, on the purchase order. Yardage shown must be used.

See terms and conditions for contrasting upholstery upcharges.

- A) One fabric or leather for seat cushion
yardage: 7.5 yds. leather: 122.0 sq. ft.
- B) One fabric or leather for inside back and outside back
yardage: 4.5 yds. leather: 73.0 sq. ft.

SCS Indoor Advantage™ Gold and LEVEL® 2 certified. See terms and conditions for additional environmental information.

Seat Height	Arm Height	W	D	H	Fabric	Leather	Weight	Cubes/Qty
16½"	-	103"	31¼ -34¼"	29"	10.25 yds.	150.0'	205 lbs.	97.97'/1
419 mm	-	2616 mm	794-870 mm	737 mm	9.4 m	14.0 sqm	93.2 kg	2.77 cu.

COM	COL	1	2	3	4	5	6	7	8	9	10	11
5335	5540	6292	6452	6543	6725	6884	6953	7067	7226	7363	7522	8433

flared front sofa - armless

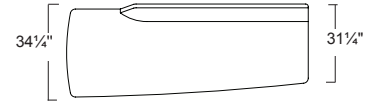

mirador 8020CL

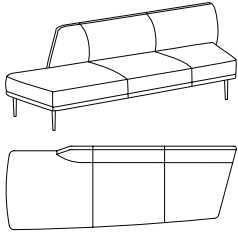

Three-seat armless module
Closed angle end
Polished aluminum base
Upholstered

All necessary ganging brackets are included and pre-installed

When using a combination of fabrics or leathers, specify the application by designating the appropriate letter, shown below, on the purchase order. Yardage shown must be used.

See terms and conditions for contrasting upholstery upcharges.

- A) One fabric or leather for seat cushion
yardage: 7.5 yds. leather: 122.0 sq. ft.
- B) One fabric or leather for inside back and outside back
yardage: 4.5 yds. leather: 73.0 sq. ft.

SCS Indoor Advantage™ Gold and LEVEL® 2 certified. See terms and conditions for additional environmental information.

Seat Height	Arm Height	W	D	H	Fabric	Leather	Weight	Cubes/Qty
16½"	-	96"	31¼ -34¼"	29"	10.25 yds.	150.0'	200 lbs.	101.65/1
419 mm	-	2438 mm	794-870 mm	737 mm	9.4 m	14.0 sqm	90.9 kg	2.87 cu.

COM	COL	1	2	3	4	5	6	7	8	9	10	11
5335	5540	6292	6452	6543	6725	6884	6953	7067	7226	7363	7522	8433

mirador 8021AR

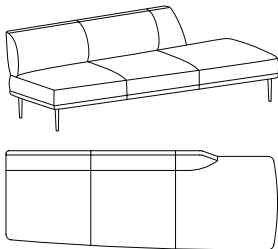

Three-seat armless module
Straight end
Polished aluminum base
Upholstered

All necessary ganging brackets are included and pre-installed

When using a combination of fabrics or leathers, specify the application by designating the appropriate letter, shown below, on the purchase order. Yardage shown must be used.

See terms and conditions for contrasting upholstery upcharges.

- A) One fabric or leather for seat cushion
yardage: 7.5 yds. leather: 122.0 sq. ft.
- B) One fabric or leather for inside back and outside back
yardage: 4.5 yds. leather: 73.0 sq. ft.

SCS Indoor Advantage™ Gold and LEVEL® 2 certified. See terms and conditions for additional environmental information.

Seat Height	Arm Height	W	D	H	Fabric	Leather	Weight	Cubes/Qty
16½"	-	96"	31¼ -34¼"	29"	10.25 yds.	150.0'	200 lbs.	101.65/1
419 mm	-	2438 mm	794-870 mm	737 mm	9.4 m	14.0 sqm	90.9 kg	2.87 cu.

COM	COL	1	2	3	4	5	6	7	8	9	10	11
5335	5540	6292	6452	6543	6725	6884	6953	7067	7226	7363	7522	8433

flared front sofa - armless

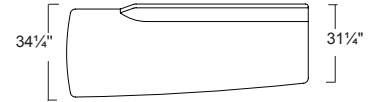

mirador 8021BR

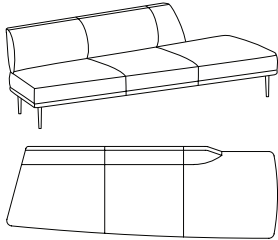

Three-seat armless module
Open angle end
Polished aluminum base
Upholstered

All necessary ganging brackets are included and pre-installed

When using a combination of fabrics or leathers, specify the application by designating the appropriate letter, shown below, on the purchase order. Yardage shown must be used.

See terms and conditions for contrasting upholstery upcharges.

- A) One fabric or leather for seat cushion
yardage: 7.5 yds. leather: 122.0 q. ft.
- B) One fabric or leather for inside back and outside back
yardage: 4.5 yds. leather: 73.0 sq. ft.

SCS Indoor Advantage™ Gold and LEVEL® 2 certified. See terms and conditions for additional environmental information.

Seat Height	Arm Height	W	D	H	Fabric	Leather	Weight	Cubes/Qty
16½"	-	103"	31¼ -34¼"	29"	10.25 yds.	150.0'	205 lbs.	97.97/1
419 mm	-	2616 mm	794-870 mm	737 mm	9.4 m	14.0 sqm	93.2 kg	2.77 cu.

COM	COL	1	2	3	4	5	6	7	8	9	10	11
5335	5540	6292	6452	6543	6725	6884	6953	7067	7226	7363	7522	8433

mirador 8021CR

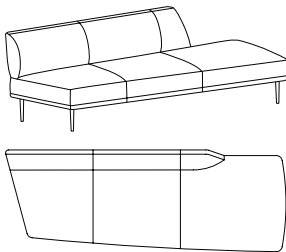

Three-seat armless module
Closed angle end
Polished aluminum base
Upholstered

All necessary ganging brackets are included and pre-installed

When using a combination of fabrics or leathers, specify the application by designating the appropriate letter, shown below, on the purchase order. Yardage shown must be used.

See terms and conditions for contrasting upholstery upcharges.

- A) One fabric or leather for seat cushion
yardage: 7.5 yds. leather: 122.0 sq. ft.
- B) One fabric or leather for inside back and outside back
yardage: 4.5 yds. leather: 73.0 sq. ft.

SCS Indoor Advantage™ Gold and LEVEL® 2 certified. See terms and conditions for additional environmental information.

Seat Height	Arm Height	W	D	H	Fabric	Leather	Weight	Cubes/Qty
16½"	-	96"	31¼ -34¼"	29"	10.25 yds.	150.0'	200 lbs.	101.65/1
419 mm	-	2438 mm	794-870 mm	737 mm	9.4 m	14.0 sqm	90.9 kg	2.87 cu.

COM	COL	1	2	3	4	5	6	7	8	9	10	11
5335	5540	6292	6452	6543	6725	6884	6953	7067	7226	7363	7522	8433

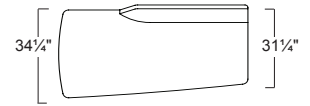

mirador 8022AL

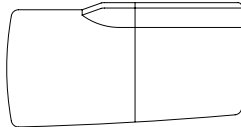
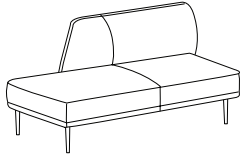

Two-seat armless module
Straight end
Polished aluminum base
Upholstered

All necessary ganging brackets are included and pre-installed

When using a combination of fabrics or leathers, specify the application by designating the appropriate letter, shown below, on the purchase order. Yardage shown must be used.

See terms and conditions for contrasting upholstery upcharges.

- A) One fabric or leather for seat cushion
 yardage: 5.5 yds. leather: 90.0 sq. ft.
- B) One fabric or leather for inside back and outside back
 yardage: 3.0 yds. leather: 50.0 sq. ft.

SCS Indoor Advantage™ Gold and LEVEL® 2 certified. See terms and conditions for additional environmental information.

Seat Height	Arm Height	W	D	H	Fabric	Leather	Weight	Cubes/Qty
16½"	-	66"	31¼ -34¼"	29"	7.5 yds.	100.0'	142 lbs.	68.33'/1
419 mm	-	1676 mm	794-870 mm	737 mm	6.9 m	9.3 sqm	64.5 kg	1.93 cu.

COM	COL	1	2	3	4	5	6	7	8	9	10	11
4444	4594	5144	5261	5328	5461	5578	5628	5711	5828	5928	6044	6711

mirador 8022BL

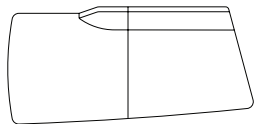
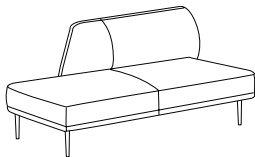

Two-seat armless module
Open angle end
Polished aluminum base
Upholstered

All necessary ganging brackets are included and pre-installed

When using a combination of fabrics or leathers, specify the application by designating the appropriate letter, shown below, on the purchase order. Yardage shown must be used.

See terms and conditions for contrasting upholstery upcharges.

- A) One fabric or leather for seat cushion
 yardage: 5.5 yds. leather: 90.0 sq. ft.
- B) One fabric or leather for inside back and outside back
 yardage: 3.0 yds. leather: 50.0 sq. ft.

SCS Indoor Advantage™ Gold and LEVEL® 2 certified. See terms and conditions for additional environmental information.

Seat Height	Arm Height	W	D	H	Fabric	Leather	Weight	Cubes/Qty
16½"	-	73"	31¼ -34¼"	29"	7.5 yds.	100.0'	147 lbs.	80.67'/1
419 mm	-	1854 mm	794-870 mm	737 mm	6.9 m	9.3 sqm	66.8 kg	2.28cu.

COM	COL	1	2	3	4	5	6	7	8	9	10	11
4444	4594	5144	5261	5328	5461	5578	5628	5711	5828	5928	6044	6711

flared front settee - armless

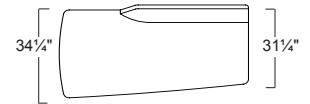

mirador 8022CL

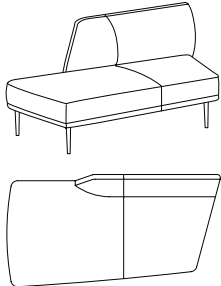

Two-seat armless module
Closed angle end
Polished aluminum base
Upholstered

All necessary ganging brackets are included and pre-installed

When using a combination of fabrics or leathers, specify the application by designating the appropriate letter, shown below, on the purchase order. Yardage shown must be used.

See terms and conditions for contrasting upholstery upcharges.

- A) One fabric or leather for seat cushion
yardage: 5.5 yds. leather: 90.0 sq. ft.
- B) One fabric or leather for inside back and outside back
yardage: 3.0 yds. leather: 50.0 sq. ft.

SCS Indoor Advantage™ Gold and LEVEL® 2 certified. See terms and conditions for additional environmental information.

Seat Height	Arm Height	W	D	H	Fabric	Leather	Weight	Cubes/Qty
16½"	-	66"	31¼ -34¼"	29"	7.5 yds.	100.0'	142 lbs.	68.33'/1
419 mm	-	1676 mm	794-870 mm	29"	6.9 m	9.3 sqm	64.5 kg	1.93 cu.

COM	COL	1	2	3	4	5	6	7	8	9	10	11
4444	4594	5144	5261	5328	5461	5578	5628	5711	5828	5928	6044	6711

mirador 8023AR

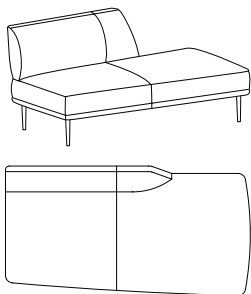

Two-seat armless module
Straight end
Polished aluminum base
Upholstered

All necessary ganging brackets are included and pre-installed

When using a combination of fabrics or leathers, specify the application by designating the appropriate letter, shown below, on the purchase order. Yardage shown must be used.

See terms and conditions for contrasting upholstery upcharges.

- A) One fabric or leather for seat cushion
yardage: 5.5 yds. leather: 90.0 sq. ft.
- B) One fabric or leather for inside back and outside back
yardage: 3.0 yds. leather: 50.0 sq. ft.

SCS Indoor Advantage™ Gold and LEVEL® 2 certified. See terms and conditions for additional environmental information.

Seat Height	Arm Height	W	D	H	Fabric	Leather	Weight	Cubes/Qty
16½"	-	66"	31¼ -34¼"	29"	7.5 yds.	100.0'	142 lbs.	68.33'/1
419 mm	-	1676 mm	794-870 mm	737 mm	6.9 m	9.3 sqm	64.5 kg	1.93 cu.

COM	COL	1	2	3	4	5	6	7	8	9	10	11
4444	4594	5144	5261	5328	5461	5578	5628	5711	5828	5928	6044	6711

flared front settee - armless

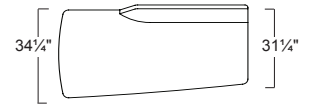

mirador 8023BR

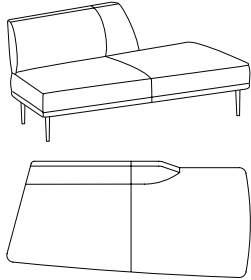

Two-seat armless module
Open angle end
Polished aluminum base
Upholstered

All necessary ganging brackets are included and pre-installed

When using a combination of fabrics or leathers, specify the application by designating the appropriate letter, shown below, on the purchase order. Yardage shown must be used.

See terms and conditions for contrasting upholstery upcharges.

- A) One fabric or leather for seat cushion
yardage: 5.5 yds. leather: 90.0 sq. ft.
- B) One fabric or leather for inside back and outside back
yardage: 3.0 yds. leather: 50.0 sq. ft.

SCS Indoor Advantage™ Gold and LEVEL® 2 certified. See terms and conditions for additional environmental information.

Seat Height	Arm Height	W	D	H	Fabric	Leather	Weight	Cubes/Qty
16½"	-	73"	31¼ -34¼"	29"	7.5 yds.	100.0'	147 lbs.	80.67/1
419 mm	-	1854 mm	794-870 mm	737 mm	6.9 m	9.3 sqm	66.8 kg	2.28cu.

COM	COL	1	2	3	4	5	6	7	8	9	10	11
4444	4594	5144	5261	5328	5461	5578	5628	5711	5828	5928	6044	6711

mirador 8023CR

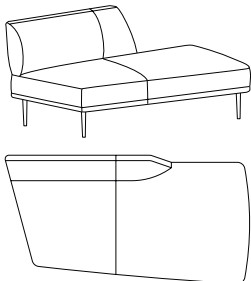

Two-seat armless module
Closed angle end
Polished aluminum base
Upholstered

All necessary ganging brackets are included and pre-installed

When using a combination of fabrics or leathers, specify the application by designating the appropriate letter, shown below, on the purchase order. Yardage shown must be used.

See terms and conditions for contrasting upholstery upcharges.

- A) One fabric or leather for seat cushion
yardage: 5.5 yds. leather: 90.0 sq. ft.
- B) One fabric or leather for inside back and outside back
yardage: 3.0 yds. leather: 50.0 sq. ft.

SCS Indoor Advantage™ Gold and LEVEL® 2 certified. See terms and conditions for additional environmental information.

Seat Height	Arm Height	W	D	H	Fabric	Leather	Weight	Cubes/Qty
16½"	-	66"	31¼ -34¼"	29"	7.5 yds.	100.0'	142 lbs.	68.33/1
419 mm	-	1676 mm	794-870 mm	737 mm	6.9 m	9.3 sqm	64.5 kg	1.93 cu.

COM	COL	1	2	3	4	5	6	7	8	9	10	11
4444	4594	5144	5261	5328	5461	5578	5628	5711	5828	5928	6044	6711

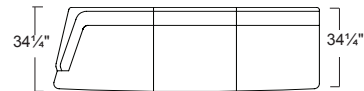

mirador 8016 BL

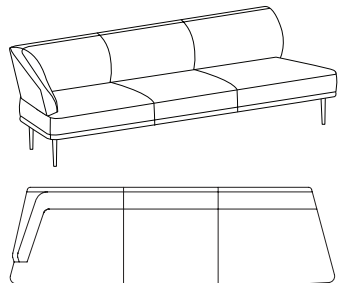

Three-seat module
Left arm facing
Open angle end
Polished aluminum base
Upholstered

All necessary ganging brackets are included and pre-installed

When using a combination of fabrics or leathers, specify the application by designating the appropriate letter, shown below, on the purchase order. Yardage shown must be used.

See terms and conditions for contrasting upholstery upcharges.

- A) One fabric or leather for seat cushion
 yardage: 7.5 yds. leather: 122.0 sq. ft.
- B) One fabric or leather for inside back, outside back and side arm
 yardage: 5.75 yds. leather: 95.0 sq. ft.

SCS Indoor Advantage™ Gold and LEVEL® 2 certified. See terms and conditions for additional environmental information.

Seat Height	Arm Height	W	D	H	Fabric	Leather	Weight	Cubes/Qty
16½"	21½ -29"	103"	31¼"	29"	11.2 yds.	168.0'	225 lbs.	97.97'/1
419 mm	546-737 mm	2616 mm	794 mm	737 mm	10.3 m	15.6 sqm	102.3 kg	2.77 cu.

COM	COL	1	2	3	4	5	6	7	8	9	10	11
6219	6439	7246	7417	7515	7711	7882	7955	8077	8248	8395	8566	9544

mirador 8016AL

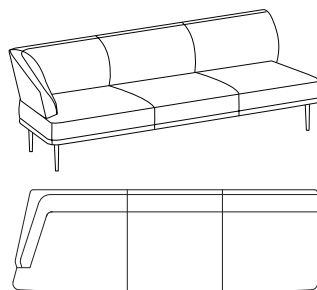

Three-seat module
Left arm facing
Straight end
Polished aluminum base
Upholstered

All necessary ganging brackets are included and pre-installed

When using a combination of fabrics or leathers, specify the application by designating the appropriate letter, shown below, on the purchase order. Yardage shown must be used.

See terms and conditions for contrasting upholstery upcharges.

- A) One fabric or leather for seat cushion
 yardage: 7.5 yds. leather: 122.0 sq. ft.
- B) One fabric or leather for inside back, outside back and side arm
 yardage: 5.75 yds. leather: 95.0 sq. ft.

SCS Indoor Advantage™ Gold and LEVEL® 2 certified. See terms and conditions for additional environmental information.

Seat Height	Arm Height	W	D	H	Fabric	Leather	Weight	Cubes/Qty
16½"	21½ -29"	96"	31¼"	29"	11.2 yds.	168.0'	220 lbs.	101.65'/1
419 mm	546-737 mm	2438 mm	794 mm	737 mm	10.3 m	15.6 sqm	100.0 kg	2.87 cu.

COM	COL	1	2	3	4	5	6	7	8	9	10	11
6219	6439	7246	7417	7515	7711	7882	7955	8077	8248	8395	8566	9544

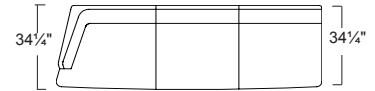

mirador 8016CL

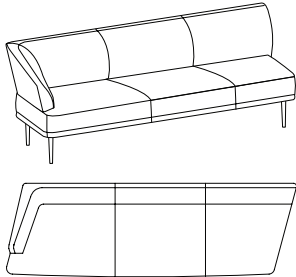

Three-seat module
Left arm facing
Closed angle end
Polished aluminum base
Upholstered

All necessary ganging brackets are included and pre-installed

When using a combination of fabrics or leathers, specify the application by designating the appropriate letter, shown below, on the purchase order. Yardage shown must be used.

See terms and conditions for contrasting upholstery upcharges.

- A) One fabric or leather for seat cushion
 yardage: 7.5 yds. leather: 122.0 sq. ft.
- B) One fabric or leather for inside back, outside back and side arm
 yardage: 5.75 yds. leather: 95.0 sq. ft.

SCS Indoor Advantage™ Gold and LEVEL® 2 certified. See terms and conditions for additional environmental information.

Seat Height	Arm Height	W	D	H	Fabric	Leather	Weight	Cubes/Qty
16½"	21½ -29"	96"	31¼"	29"	11.2 yds.	168.0'	220 lbs.	101.65/1
419 mm	546-737 mm	2438 mm	794 mm	737 mm	10.3 m	15.6 sqm	100.0 kg	2.87 cu.

COM	COL	1	2	3	4	5	6	7	8	9	10	11
6219	6439	7246	7417	7515	7711	7882	7955	8077	8248	8395	8566	9544

mirador 8017AR

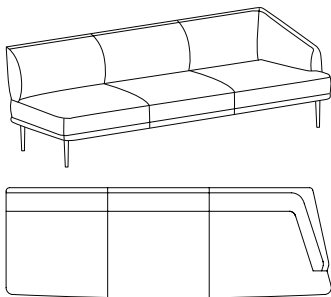

Three-seat module
Right arm facing
Straight end
Polished aluminum base
Upholstered

All necessary ganging brackets are included and pre-installed

When using a combination of fabrics or leathers, specify the application by designating the appropriate letter, shown below, on the purchase order. Yardage shown must be used.

See terms and conditions for contrasting upholstery upcharges.

- A) One fabric or leather for seat cushion
 yardage: 7.5 yds. leather: 122.0 sq. ft.
- B) One fabric or leather for inside back, outside back and side arm
 yardage: 5.75 yds. leather: 95.0 sq. ft.

SCS Indoor Advantage™ Gold and LEVEL® 2 certified. See terms and conditions for additional environmental information.

Seat Height	Arm Height	W	D	H	Fabric	Leather	Weight	Cubes/Qty
16½"	21½ -29"	96"	31¼"	29"	11.2 yds.	168.0'	220 lbs.	101.65/1
419 mm	546-737 mm	2438 mm	794 mm	737 mm	10.3 m	15.6 sqm	100.0 kg	2.87 cu.

COM	COL	1	2	3	4	5	6	7	8	9	10	11
6219	6439	7246	7417	7515	7711	7882	7955	8077	8248	8395	8566	9544

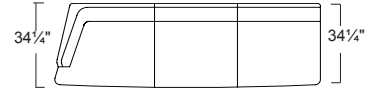

mirador 8017BR

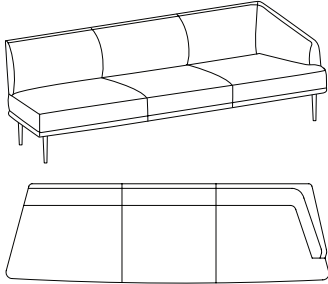

Three-seat module
Right arm facing
Open angle end
Polished aluminum base
Upholstered

All necessary ganging brackets are included and pre-installed

When using a combination of fabrics or leathers, specify the application by designating the appropriate letter, shown below, on the purchase order. Yardage shown must be used.

See terms and conditions for contrasting upholstery upcharges.

- A) One fabric or leather for seat cushion
 yardage: 7.5 yds. leather: 122.0 sq. ft.
- B) One fabric or leather for inside back, outside back and side arm
 yardage: 5.75 yds. leather: 95.0 sq. ft.

SCS Indoor Advantage™ Gold and LEVEL® 2 certified. See terms and conditions for additional environmental information.

Seat Height	Arm Height	W	D	H	Fabric	Leather	Weight	Cubes/Qty
16½"	21½"-29"	103"	31¼"	29"	11.2 yds.	168.0'	225 lbs.	97.97'/1
419 mm	546-737 mm	2616 mm	794 mm	737 mm	10.3 m	15.6 sqm	102.3 kg	2.77 cu.

COM	COL	1	2	3	4	5	6	7	8	9	10	11
6219	6439	7246	7417	7515	7711	7882	7955	8077	8248	8395	8566	9544

mirador 8017CR

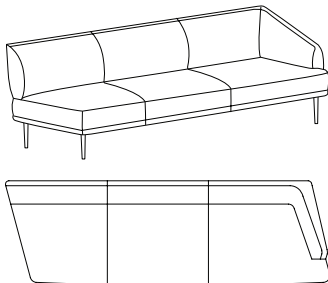

Three-seat module
Right arm facing
Closed angle end
Polished aluminum base
Upholstered

All necessary ganging brackets are included and pre-installed

When using a combination of fabrics or leathers, specify the application by designating the appropriate letter, shown below, on the purchase order. Yardage shown must be used.

See terms and conditions for contrasting upholstery upcharges.

- A) One fabric or leather for seat cushion
 yardage: 7.5 yds. leather: 122.0 sq. ft.
- B) One fabric or leather for inside back, outside back and side arm
 yardage: 5.75 yds. leather: 95.0 sq. ft.

SCS Indoor Advantage™ Gold and LEVEL® 2 certified. See terms and conditions for additional environmental information.

Seat Height	Arm Height	W	D	H	Fabric	Leather	Weight	Cubes/Qty
16½"	21½"-29"	96"	31¼"	29"	11.2 yds.	168.0'	220 lbs.	101.65'/1
419 mm	546-737 mm	2438 mm	794 mm	737 mm	10.3 m	15.6 sqm	100.0 kg	2.87 cu.

COM	COL	1	2	3	4	5	6	7	8	9	10	11
6219	6439	7246	7417	7515	7711	7882	7955	8077	8248	8395	8566	9544

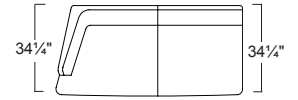

mirador 8018AL

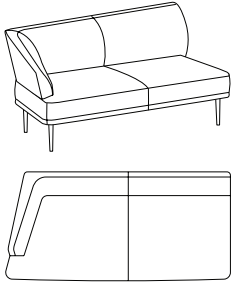

Two-seat module
Left arm facing
Straight end
Polished aluminum base
Upholstered

All necessary ganging brackets are included and pre-installed

When using a combination of fabrics or leathers, specify the application by designating the appropriate letter, shown below, on the purchase order. Yardage shown must be used.

See terms and conditions for contrasting upholstery upcharges.

- A) One fabric or leather for seat cushion
 yardage: 5.5 yds. leather: 90.0 sq. ft.
- B) One fabric or leather for inside back, outside back and side arm
 yardage: 4.25 yds. leather: 70.0 sq. ft.

SCS Indoor Advantage™ Gold and LEVEL® 2 certified. See terms and conditions for additional environmental information.

Seat Height	Arm Height	W	D	H	Fabric	Leather	Weight	Cubes/Qty
16½"	21½ -29"	66"	31¼"	29"	8.5 yds.	144.0'	152 lbs.	68.33'/1
419 mm	546-737 mm	1676 mm	794 mm	737 mm	7.8 m	13.4 sqm	69.1 kg	1.93 cu.

COM	COL	1	2	3	4	5	6	7	8	9	10	11
4978	5148	5772	5904	5980	6131	6263	6320	6414	6546	6660	6792	7547

mirador 8018BL

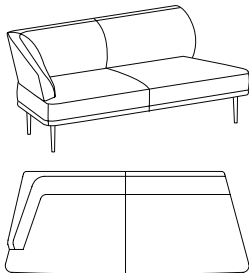

Two-seat module
Left arm facing
Open angle end
Polished aluminum base
Upholstered

All necessary ganging brackets are included and pre-installed

When using a combination of fabrics or leathers, specify the application by designating the appropriate letter, shown below, on the purchase order. Yardage shown must be used.

See terms and conditions for contrasting upholstery upcharges.

- A) One fabric or leather for seat cushion
 yardage: 5.5 yds. leather: 90.0 sq. ft.
- B) One fabric or leather for inside back, outside back and side arm
 yardage: 4.25 yds. leather: 70.0 sq. ft.

SCS Indoor Advantage™ Gold and LEVEL® 2 certified. See terms and conditions for additional environmental information.

Seat Height	Arm Height	W	D	H	Fabric	Leather	Weight	Cubes/Qty
16½"	21½ -29"	73"	31¼"	29"	8.5 yds.	144.0'	157 lbs.	80.67'/1
419 mm	546-737 mm	1854 mm	794 mm	737 mm	7.8 m	13.4 sqm	71.4 kg	2.28 cu.

COM	COL	1	2	3	4	5	6	7	8	9	10	11
4978	5148	5772	5904	5980	6131	6263	6320	6414	6546	6660	6792	7547

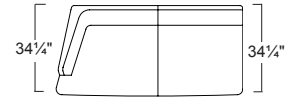

mirador 8018CL

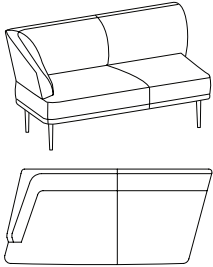

Two-seat module
Left arm facing
Closed angle end
Polished aluminum base
Upholstered

All necessary ganging brackets are included and pre-installed

When using a combination of fabrics or leathers, specify the application by designating the appropriate letter, shown below, on the purchase order. Yardage shown must be used.

See terms and conditions for contrasting upholstery upcharges.

- A) One fabric or leather for seat cushion
 yardage: 5.5 yds. leather: 90.0 sq. ft.
- B) One fabric or leather for inside back, outside back and side arm
 yardage: 4.25 yds. leather: 70.0 sq. ft.

SCS Indoor Advantage™ Gold and LEVEL® 2 certified. See terms and conditions for additional environmental information.

Seat Height	Arm Height	W	D	H	Fabric	Leather	Weight	Cubes/Qty
16½"	21½ -29"	66"	31¼"	29"	8.5 yds.	144.0'	152 lbs.	68.33'/1
419 mm	546-737 mm	1676 mm	794 mm	737 mm	7.8 m	13.4 sqm	69.1 kg	1.93 cu.

COM	COL	1	2	3	4	5	6	7	8	9	10	11
4978	5148	5772	5904	5980	6131	6263	6320	6414	6546	6660	6792	7547

mirador 8019AR

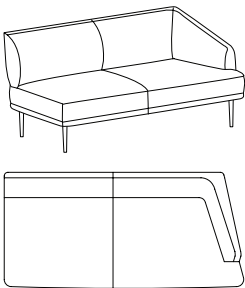

Two-seat module
Right arm facing
Straight end
Polished aluminum base
Upholstered

All necessary ganging brackets are included and pre-installed

When using a combination of fabrics or leathers, specify the application by designating the appropriate letter, shown below, on the purchase order. Yardage shown must be used.

See terms and conditions for contrasting upholstery upcharges.

- A) One fabric or leather for seat cushion
 yardage: 5.5 yds. leather: 90.0 sq. ft.
- B) One fabric or leather for inside back, outside back and side arm
 yardage: 4.25 yds. leather: 70.0 sq. ft.

SCS Indoor Advantage™ Gold and LEVEL® 2 certified. See terms and conditions for additional environmental information.

Seat Height	Arm Height	W	D	H	Fabric	Leather	Weight	Cubes/Qty
16½"	21½ -29"	66"	31¼"	29"	8.5 yds.	144.0'	152 lbs.	68.33'/1
419 mm	546-737 mm	1676 mm	794 mm	737 mm	7.8 m	13.4 sqm	69.1 kg	1.93 cu.

COM	COL	1	2	3	4	5	6	7	8	9	10	11
4978	5148	5772	5904	5980	6131	6263	6320	6414	6546	6660	6792	7547

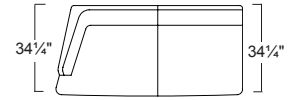

mirador 8019BR

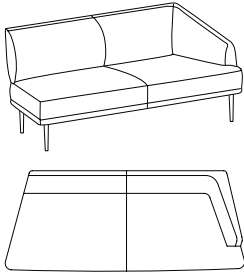

Two-seat module
Right arm facing
Open angle end
Polished aluminum base
Upholstered

All necessary ganging brackets are included and pre-installed

When using a combination of fabrics or leathers, specify the application by designating the appropriate letter, shown below, on the purchase order. Yardage shown must be used.

See terms and conditions for contrasting upholstery upcharges.

- A) One fabric or leather for seat cushion
 yardage: 5.5 yds. leather: 90.0 sq. ft.
- B) One fabric or leather for inside back, outside back and side arm
 yardage: 4.25 yds. leather: 70.0 sq. ft.

SCS Indoor Advantage™ Gold and LEVEL® 2 certified. See terms and conditions for additional environmental information.

Seat Height	Arm Height	W	D	H	Fabric	Leather	Weight	Cubes/Qty
16½"	21½"-29"	73"	31¼"	29"	8.5 yds.	144.0'	157 lbs.	80.67'/1
419 mm	546-737 mm	1854 mm	794 mm	737 mm	7.8 m	13.4 sqm	71.4 kg	2.28 cu.

COM	COL	1	2	3	4	5	6	7	8	9	10	11
4978	5148	5772	5904	5980	6131	6263	6320	6414	6546	6660	6792	7547

mirador 8019CR

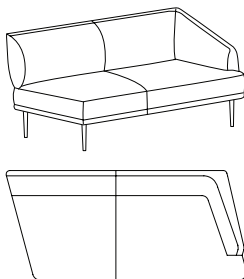

Two-seat module
Right arm facing
Closed angle end
Polished aluminum base
Upholstered

All necessary ganging brackets are included and pre-installed

When using a combination of fabrics or leathers, specify the application by designating the appropriate letter, shown below, on the purchase order. Yardage shown must be used.

See terms and conditions for contrasting upholstery upcharges.

- A) One fabric or leather for seat cushion
 yardage: 5.5 yds. leather: 90.0 sq. ft.
- B) One fabric or leather for inside back, outside back and side arm
 yardage: 4.25 yds. leather: 70.0 sq. ft.

SCS Indoor Advantage™ Gold and LEVEL® 2 certified. See terms and conditions for additional environmental information.

Seat Height	Arm Height	W	D	H	Fabric	Leather	Weight	Cubes/Qty
16½"	21½"-29"	66"	31¼"	29"	8.5 yds.	144.0'	152 lbs.	68.33'/1
419 mm	546-737 mm	1676 mm	794 mm	737 mm	7.8 m	13.4 sqm	69.1 kg	1.93 cu.

COM	COL	1	2	3	4	5	6	7	8	9	10	11
4978	5148	5772	5904	5980	6131	6263	6320	6414	6546	6660	6792	7547



mirador 8026AL

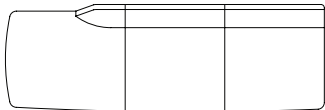
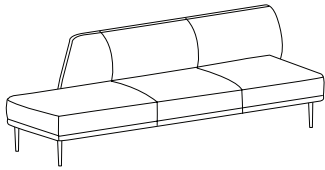

Three-seat armless
Straight end
Polished aluminum base
Upholstered

All necessary ganging brackets are included and pre-installed

When using a combination of fabrics or leathers, specify the application by designating the appropriate letter, shown below, on the purchase order. Yardage shown must be used.

See terms and conditions for contrasting upholstery upcharges.

- A) One fabric or leather for seat cushion
 yardage: 7.5 yds. leather: 122.0 sq. ft.
- B) One fabric or leather for inside back and outside back
 yardage: 4.5 yds. leather: 73.0 sq. ft.

CS Indoor Advantage™ Gold and LEVEL® 2 certified. See terms and conditions for additional environmental information.

Seat Height	Arm Height	W	D	H	Fabric	Leather	Weight	Cubes/Qty
16½"	-	96"	31¼"	29"	10.2 yds.	150.0'	201 lbs.	101.65'/1
419 mm	-	2438 mm	794 mm	737 mm	9.4 m	14.0 sqm	91.4 kg	2.87 cu.

COM	COL	1	2	3	4	5	6	7	8	9	10	11
5335	5540	6292	6452	6543	6725	6884	6953	7067	7226	7363	7522	8433

mirador 8026BL

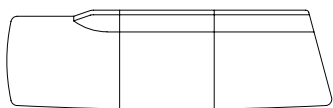
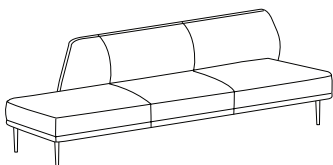

Three-seat armless
Open angle end
Polished aluminum base
Upholstered

All necessary ganging brackets are included and pre-installed

When using a combination of fabrics or leathers, specify the application by designating the appropriate letter, shown below, on the purchase order. Yardage shown must be used.

See terms and conditions for contrasting upholstery upcharges.

- A) One fabric or leather for seat cushion
 yardage: 7.5 yds. leather: 122.0 sq. ft.
- B) One fabric or leather for inside back and outside back
 yardage: 4.5 yds. leather: 73.0 sq. ft.

SCS Indoor Advantage™ Gold and LEVEL® 2 certified. See terms and conditions for additional environmental information.

Seat Height	Arm Height	W	D	H	Fabric	Leather	Weight	Cubes/Qty
16½"	-	103"	31¼"	29"	10.2 yds.	150.0'	206 lbs.	97.97'/1
419 mm	-	2616 mm	794 mm	737 mm	9.4 m	14.0 sqm	93.6 kg	2.77 cu.

COM	COL	1	2	3	4	5	6	7	8	9	10	11
5335	5540	6292	6452	6543	6725	6884	6953	7067	7226	7363	7522	8433

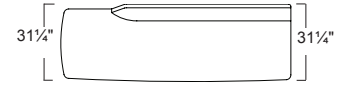

mirador 8026CL

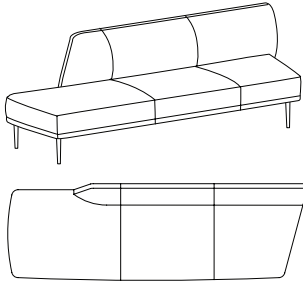

Three-seat armless
Closed angle end
Polished aluminum base
Upholstered

All necessary ganging brackets are included and pre-installed

When using a combination of fabrics or leathers, specify the application by designating the appropriate letter, shown below, on the purchase order. Yardage shown must be used.

See terms and conditions for contrasting upholstery upcharges.

- A) One fabric or leather for seat cushion
 yardage: 7.5 yds. leather: 122.0 sq. ft.
- B) One fabric or leather for inside back and outside back
 yardage: 4.5 yds. leather: 73.0 sq. ft.

SCS Indoor Advantage™ Gold and LEVEL® 2 certified. See terms and conditions for additional environmental information.

Seat Height	Arm Height	W	D	H	Fabric	Leather	Weight	Cubes/Qty
16½"	-	96"	31¼"	29"	10.2 yds.	150.0'	201 lbs.	101.65/1
419 mm	-	2438 mm	794 mm	737 mm	9.4 m	14.0 sqm	91.4 kg	101.65/1

COM	COL	1	2	3	4	5	6	7	8	9	10	11
5335	5540	6292	6452	6543	6725	6884	6953	7067	7226	7363	7522	8433

mirador 8027AR

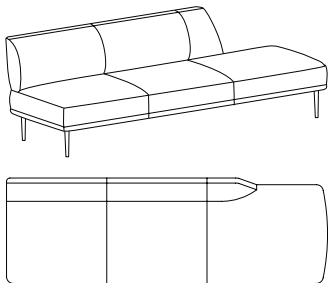

Three-seat armless
Straight end
Polished aluminum base
Upholstered

All necessary ganging brackets are included and pre-installed

When using a combination of fabrics or leathers, specify the application by designating the appropriate letter, shown below, on the purchase order. Yardage shown must be used.

See terms and conditions for contrasting upholstery upcharges.

- A) One fabric or leather for seat cushion
 yardage: 7.5 yds. leather: 122.0 sq. ft.
- B) One fabric or leather for inside back and outside back
 yardage: 4.5 yds. leather: 73.0 sq. ft.

SCS Indoor Advantage™ Gold and LEVEL® 2 certified. See terms and conditions for additional environmental information.

Seat Height	Arm Height	W	D	H	Fabric	Leather	Weight	Cubes/Qty
16½"	-	96"	31¼"	29"	10.2 yds.	150.0'	201 lbs.	101.65/1
419 mm	-	2438 mm	794 mm	737 mm	9.4 m	14.0 sqm	91.4 kg	2.87 cu.

COM	COL	1	2	3	4	5	6	7	8	9	10	11
5335	5540	6292	6452	6543	6725	6884	6953	7067	7226	7363	7522	8433



mirador 8027BR

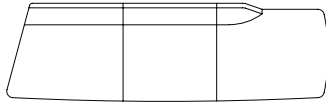
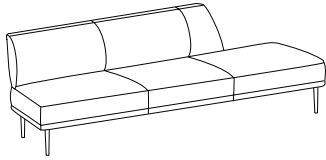

Three-seat armless
Open angle end
Polished aluminum base
Upholstered

All necessary ganging brackets are included and pre-installed

When using a combination of fabrics or leathers, specify the application by designating the appropriate letter, shown below, on the purchase order. Yardage shown must be used.

See terms and conditions for contrasting upholstery upcharges.

- A) One fabric or leather for seat cushion
 yardage: 7.5 yds. leather: 122.0 sq. ft.
- B) One fabric or leather for inside back and outside back
 yardage: 4.5 yds. leather: 73.0 sq. ft.

SCS Indoor Advantage™ Gold and LEVEL® 2 certified. See terms and conditions for additional environmental information.

Seat Height	Arm Height	W	D	H	Fabric	Leather	Weight	Cubes/Qty
16½"	-	103"	31¼"	29"	10.2 yds.	150.0'	206 lbs.	97.97/1
419 mm	-	2616 mm	794 mm	737 mm	9.4 m	14.0 sqm	93.6 kg	97.97/1

COM	COL	1	2	3	4	5	6	7	8	9	10	11
5335	5540	6292	6452	6543	6725	6884	6953	7067	7226	7363	7522	8433

mirador 8027CR

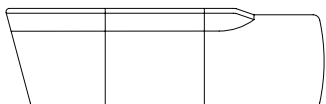
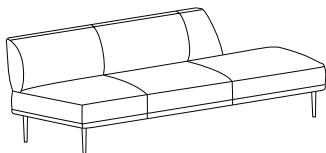

Three-seat armless
Closed angle end
Polished aluminum base
Upholstered

All necessary ganging brackets are included and pre-installed

When using a combination of fabrics or leathers, specify the application by designating the appropriate letter, shown below, on the purchase order. Yardage shown must be used.

See terms and conditions for contrasting upholstery upcharges.

- A) One fabric or leather for seat cushion
 yardage: 7.5 yds. leather: 122.0 sq. ft.
- B) One fabric or leather for inside back and outside back
 yardage: 4.5 yds. leather: 73.0 sq. ft.

SCS Indoor Advantage™ Gold and LEVEL® 2 certified. See terms and conditions for additional environmental information.

Seat Height	Arm Height	W	D	H	Fabric	Leather	Weight	Cubes/Qty
16½"	-	96"	31¼"	29"	10.2 yds.	150.0'	201 lbs.	101.65/1
419 mm	-	2438 mm	794 mm	737 mm	9.4 m	14.0 sqm	91.4 kg	2.87 cu.

COM	COL	1	2	3	4	5	6	7	8	9	10	11
5335	5540	6292	6452	6543	6725	6884	6953	7067	7226	7363	7522	8433

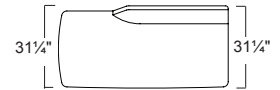

mirador 8028AL

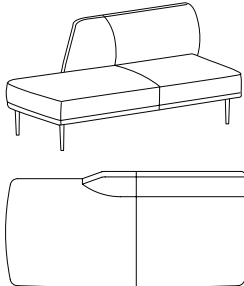

Two-seat armless
Straight end
Polished aluminum base
Upholstered

All necessary ganging brackets are included and pre-installed

When using a combination of fabrics or leathers, specify the application by designating the appropriate letter, shown below, on the purchase order. Yardage shown must be used.

See terms and conditions for contrasting upholstery upcharges.

- A) One fabric or leather for seat cushion
 yardage: 5.5 yds. leather: 90.0 sq. ft.
- B) One fabric or leather for inside back and outside back
 yardage: 3.0 yds. leather: 50.0 sq. ft.

SCS Indoor Advantage™ Gold and LEVEL® 2 certified. See terms and conditions for additional environmental information.

Seat Height	Arm Height	W	D	H	Fabric	Leather	Weight	Cubes/Qty
16½"	-	66"	31¼"	29"	7.5 yds.	100.0'	146 lbs.	68.33'/1
419 mm	-	66"	31¼"	29"	6.9 m	9.3 sqm	66.4 kg	1.93 cu.

COM	COL	1	2	3	4	5	6	7	8	9	10	11
4444	4594	5144	5261	5328	5461	5578	5628	5711	5828	5928	6044	6711

mirador 8028BL

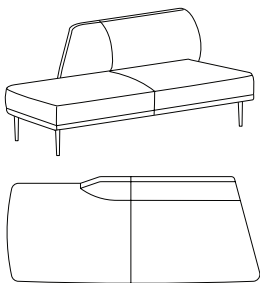

Two-seat armless
Open angle end
Polished aluminum base
Upholstered

All necessary ganging brackets are included and pre-installed

When using a combination of fabrics or leathers, specify the application by designating the appropriate letter, shown below, on the purchase order. Yardage shown must be used.

See terms and conditions for contrasting upholstery upcharges.

- A) One fabric or leather for seat cushion
 yardage: 5.5 yds. leather: 90.0 sq. ft.
- B) One fabric or leather for inside back and outside back
 yardage: 3.0 yds. leather: 50.0 sq. ft.

SCS Indoor Advantage™ Gold and LEVEL® 2 certified. See terms and conditions for additional environmental information.

Seat Height	Arm Height	W	D	H	Fabric	Leather	Weight	Cubes/Qty
16½"	-	73"	31¼"	29"	7.5 yds.	100.0'	151 lbs.	80.67'/1
419 mm	-	1854 mm	794 mm	737 mm	6.9 m	9.3 sqm	68.6 kg	2.28 cu.

COM	COL	1	2	3	4	5	6	7	8	9	10	11
4444	4594	5144	5261	5328	5461	5578	5628	5711	5828	5928	6044	6711

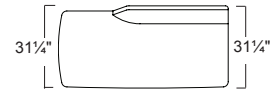

mirador 8028CL

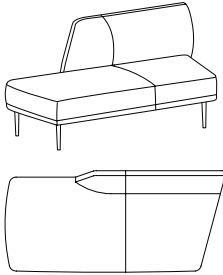

**Two-seat armless
Closed angle end
Polished aluminum base
Upholstered**

All necessary ganging brackets are included and pre-installed

When using a combination of fabrics or leathers, specify the application by designating the appropriate letter, shown below, on the purchase order. Yardage shown must be used.

See terms and conditions for contrasting upholstery upcharges.

- A) One fabric or leather for seat cushion
yardage: 5.5 yds. leather: 90.0 sq. ft.
- B) One fabric or leather for inside back and outside back
yardage: 3.0 yds. leather: 50.0 sq. ft.

SCS Indoor Advantage™ Gold and LEVEL® 2 certified. See terms and conditions for additional environmental information.

Seat Height	Arm Height	W	D	H	Fabric	Leather	Weight	Cubes/Qty
16½"	-	66"	31¼"	29"	7.5 yds.	100.0'	146 lbs.	68.33'/1
419 mm	-	1676 mm	794 mm	737 mm	6.9 m	9.3 sqm	66.4 kg	1.93 cu.

COM	COL	1	2	3	4	5	6	7	8	9	10	11
4444	4594	5144	5261	5328	5461	5578	5628	5711	5828	5928	6044	6711

mirador 8029AR

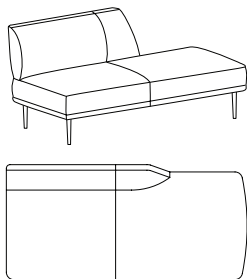

**Two-seat armless
Straight end
Polished aluminum base
Upholstered**

All necessary ganging brackets are included and pre-installed

When using a combination of fabrics or leathers, specify the application by designating the appropriate letter, shown below, on the purchase order. Yardage shown must be used.

See terms and conditions for contrasting upholstery upcharges.

- A) One fabric or leather for seat cushion
yardage: 5.5 yds. leather: 90.0 sq. ft.
- B) One fabric or leather for inside back and outside back
yardage: 3.0 yds. leather: 50.0sq. ft.

SCS Indoor Advantage™ Gold and LEVEL® 2 certified. See terms and conditions for additional environmental information.

Seat Height	Arm Height	W	D	H	Fabric	Leather	Weight	Cubes/Qty
16½"	-	66"	31¼"	29"	7.5 yds.	100.0'	146 lbs.	68.33'/1
419 mm	-	1676 mm	794 mm	737 mm	6.9 m	9.3 sqm	66.4 kg	1.93 cu.

COM	COL	1	2	3	4	5	6	7	8	9	10	11
4444	4594	5144	5261	5328	5461	5578	5628	5711	5828	5928	6044	6711

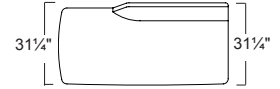

mirador 8029BR

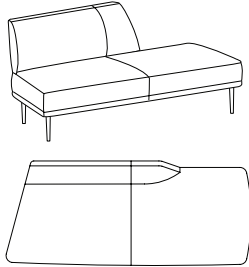

Two-seat armless
Open angle end
Polished aluminum base
Upholstered

All necessary ganging brackets are included and pre-installed

When using a combination of fabrics or leathers, specify the application by designating the appropriate letter, shown below, on the purchase order. Yardage shown must be used.

See terms and conditions for contrasting upholstery upcharges.

- A) One fabric or leather for seat cushion
 yardage: 5.5 yds. leather: 90.0 sq. ft.
- B) One fabric or leather for inside back and outside back
 yardage: 3.0 yds. leather: 50.0 sq. ft.

SCS Indoor Advantage™ Gold and LEVEL® 2 certified. See terms and conditions for additional environmental information.

Seat Height	Arm Height	W	D	H	Fabric	Leather	Weight	Cubes/Qty
16½"	-	73"	31¼"	29"	7.5 yds.	100.0'	151 lbs.	80.67/1
419 mm	-	1854 mm	794 mm	737 mm	6.9 m	9.3 sqm	68.6 kg	2.28 cu.

COM	COL	1	2	3	4	5	6	7	8	9	10	11
4444	4594	5144	5261	5328	5461	5578	5628	5711	5828	5928	6044	6711

mirador 8029CR

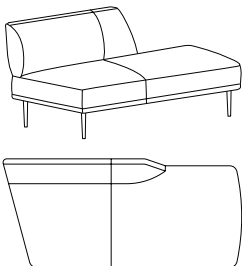

Two-seat armless
Closed angle end
Polished aluminum base
Upholstered

All necessary ganging brackets are included and pre-installed

When using a combination of fabrics or leathers, specify the application by designating the appropriate letter, shown below, on the purchase order. Yardage shown must be used.

See terms and conditions for contrasting upholstery upcharges.

- A) One fabric or leather for seat cushion
 yardage: 5.5 yds. leather: 90.0 sq. ft.
- B) One fabric or leather for inside back and outside back
 yardage: 3.0 yds. leather: 50.0 sq. ft.

SCS Indoor Advantage™ Gold and LEVEL® 2 certified. See terms and conditions for additional environmental information.

Seat Height	Arm Height	W	D	H	Fabric	Leather	Weight	Cubes/Qty
16½"	-	66"	31¼"	29"	7.5 yds.	100.0'	146 lbs.	68.33/1
419 mm	-	1676 mm	794 mm	737 mm	6.9 m	9.3 sqm	66.4 kg	1.93 cu.

COM	COL	1	2	3	4	5	6	7	8	9	10	11
4444	4594	5144	5261	5328	5461	5578	5628	5711	5828	5928	6044	6711

connecting module

mirador 8030A

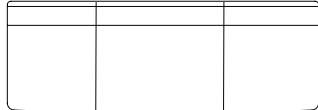
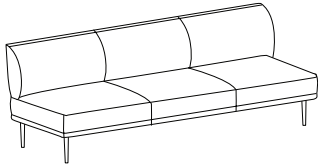

Three-seat armless
Straight ends
Polished aluminum base
Upholstered

All necessary ganging brackets are included and pre-installed

When using a combination of fabrics or leathers, specify the application by designating the appropriate letter, shown below, on the purchase order. Yardage shown must be used.

See terms and conditions for contrasting upholstery upcharges.

- A) One fabric or leather for seat cushion
yardage: 7.5 yds. leather: 122.0 sq. ft.
- B) One fabric or leather for inside back and outside back
yardage: 5.5 yds. leather: 90.0 sq. ft.

SCS Indoor Advantage™ Gold and LEVEL® 2 certified. See terms and conditions for additional environmental information.

Seat Height	Arm Height	W	D	H	Fabric	Leather	Weight	Cubes/Qty
16½"	-	90"	31¼"	29"	11.0 yds.	160.0'	210 lbs.	101.65'/1
419 mm	-	2280 mm	794 mm	737 mm	10.0 m	14.9 sqm	95.5 kg	2.87 cu.

COM	COL	1	2	3	4	5	6	7	8	9	10	11
5156	5376	6183	6354	6452	6648	6819	6892	7014	7185	7332	7503	8481

mirador 8030B

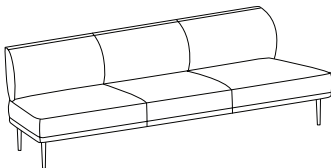

Three-seat armless
Open angle ends
Polished aluminum base
Upholstered

All necessary ganging brackets are included and pre-installed

When using a combination of fabrics or leathers, specify the application by designating the appropriate letter, shown below, on the purchase order. Yardage shown must be used.

See terms and conditions for contrasting upholstery upcharges.

- A) One fabric or leather for seat cushion
yardage: 7.5 yds. leather: 122.0 sq. ft.
- B) One fabric or leather for inside back and outside back
yardage: 5.5 yds. leather: 90.0 sq. ft.

SCS Indoor Advantage™ Gold and LEVEL® 2 certified. See terms and conditions for additional environmental information.

Seat Height	Arm Height	W	D	H	Fabric	Leather	Weight	Cubes/Qty
16½"	-	103"	31¼"	29"	11.0 yds.	160.0'	220 lbs.	97.97'/1
419 mm	-	2616 mm	794 mm	737 mm	10.0 m	14.9 sqm	100.0 kg	2.77 cu.

COM	COL	1	2	3	4	5	6	7	8	9	10	11
5156	5376	6183	6354	6452	6648	6819	6892	7014	7185	7332	7503	8481

connecting module

mirador 8030C

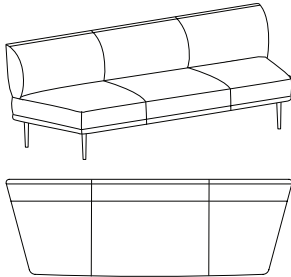

Three-seat armless
Closed angle ends
Polished aluminum base
Upholstered

All necessary ganging brackets are included and pre-installed

When using a combination of fabrics or leathers, specify the application by designating the appropriate letter, shown below, on the purchase order. Yardage shown must be used.

See terms and conditions for contrasting upholstery upcharges.

- A) One fabric or leather for seat cushion
yardage: 7.5 yds. leather: 122.0 sq. ft.
- B) One fabric or leather for inside back and outside back
yardage: 5.5 yds. leather: 90.0 sq. ft.

SCS Indoor Advantage™ Gold and LEVEL® 2 certified. See terms and conditions for additional environmental information.

Seat Height	Arm Height	W	D	H	Fabric	Leather	Weight	Cubes/Qty
16½"	-	90"	31¼"	29"	11.0 yds.	160.0'	200 lbs.	101.65'/1
419 mm	-	2286 mm	794 mm	737 mm	10.0 m	14.9 sqm	90.9 kg	2.87 cu.

COM	COL	1	2	3	4	5	6	7	8	9	10	11
5156	5376	6183	6354	6452	6648	6819	6892	7014	7185	7332	7503	8481

mirador 8031A

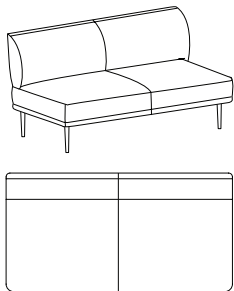

Two-seat armless
Straight ends
Polished aluminum base
Upholstered

All necessary ganging brackets are included and pre-installed

When using a combination of fabrics or leathers, specify the application by designating the appropriate letter, shown below, on the purchase order. Yardage shown must be used.

See terms and conditions for contrasting upholstery upcharges.

- A) One fabric or leather for seat cushion
yardage: 5.5 yds. leather: 90.0 sq. ft.
- B) One fabric or leather for inside back and outside back
yardage: 4.0 yds. leather: 65.0 sq. ft.

SCS Indoor Advantage™ Gold and LEVEL® 2 certified. See terms and conditions for additional environmental information.

Seat Height	Arm Height	W	D	H	Fabric	Leather	Weight	Cubes/Qty
16½"	-	60"	31¼"	29"	7.7 yds.	108.0'	139 lbs.	68.33'/1
419 mm	-	1524 mm	794 mm	737 mm	7.1 m	10.0 sqm	63.2 kg	1.93 cu.

COM	COL	1	2	3	4	5	6	7	8	9	10	11
4267	4422	4991	5111	5180	5318	5439	5490	5576	5697	5800	5921	6610

connecting module

mirador 8031B

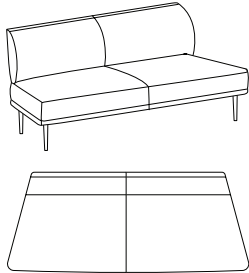

Two-seat armless
Open angle ends
Polished aluminum base
Upholstered

All necessary ganging brackets are included and pre-installed

When using a combination of fabrics or leathers, specify the application by designating the appropriate letter, shown below, on the purchase order. Yardage shown must be used.

See terms and conditions for contrasting upholstery upcharges.

- A) One fabric or leather for seat cushion
yardage: 5.5 yds. leather: 90.0 sq. ft.
- B) One fabric or leather for inside back and outside back
yardage: 4.0 yds. leather: 65.0 sq. ft.

SCS Indoor Advantage™ Gold and LEVEL® 2 certified. See terms and conditions for additional environmental information.

Seat Height	Arm Height	W	D	H	Fabric	Leather	Weight	Cubes/Qty
16½"	-	74"	31¼"	29"	7.7 yds.	108.0'	149 lbs.	80.67/1
419 mm	-	1880 mm	794 mm	737 mm	7.1 m	10.0 sqm	67.7 kg	2.28 cu.

COM	COL	1	2	3	4	5	6	7	8	9	10	11
4267	4422	4991	5111	5180	5318	5439	5490	5576	5697	5800	5921	6610

mirador 8031C

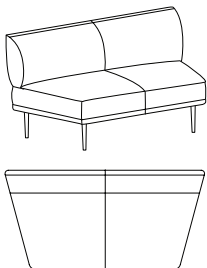

Two-seat armless
Closed angle ends
Polished aluminum base
Upholstered

All necessary ganging brackets are included and pre-installed

When using a combination of fabrics or leathers, specify the application by designating the appropriate letter, shown below, on the purchase order. Yardage shown must be used.

See terms and conditions for contrasting upholstery upcharges.

- A) One fabric or leather for seat cushion
yardage: 5.5 yds. leather: 90.0 sq. ft.
- B) One fabric or leather for inside back and outside back
yardage: 4.0 yds. leather: 65.0 sq. ft.

SCS Indoor Advantage™ Gold and LEVEL® 2 certified. See terms and conditions for additional environmental information.

Seat Height	Arm Height	W	D	H	Fabric	Leather	Weight	Cubes/Qty
16½"	-	60"	31¼"	29"	7.7 yds.	108.0'	129 lbs.	68.33/1
419 mm	-	1524 mm	794 mm	737 mm	7.1 m	10.0 sqm	58.6 kg	1.93 cu.

COM	COL	1	2	3	4	5	6	7	8	9	10	11
4267	4422	4991	5111	5180	5318	5439	5490	5576	5697	5800	5921	6610

connecting module

mirador 8032A

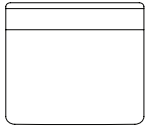
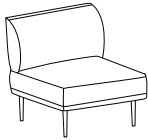

Armless
Straight ends
Polished aluminum base
Upholstered

All necessary ganging brackets are included and pre-installed

When using a combination of fabrics or leathers, specify the application by designating the appropriate letter, shown below, on the purchase order. Yardage shown must be used.

See terms and conditions for contrasting upholstery upcharges.

- A) One fabric or leather for seat cushion
yardage: 3.5 yds. leather: 57.0 sq. ft.
- B) One fabric or leather for inside back and outside back
yardage: 2.5 yds. leather: 41.0 sq. ft.

SCS Indoor Advantage™ Gold and LEVEL® 2 certified. See terms and conditions for additional environmental information.

Seat Height	Arm Height	W	D	H	Fabric	Leather	Weight	Cubes/Qty
16½"	-	30"	31¼"	29"	4.0 yds.	50.0'	68 lbs.	36.09/1
419 mm	-	762 mm	794 mm	737 mm	3.7 m	4.6 sqm	30.9 kg	1.04 cu.

COM	COL	1	2	3	4	5	6	7	8	9	10	11
2848	2928	3222	3284	3320	3391	3453	3480	3524	3586	3640	3702	4057

mirador 8032B

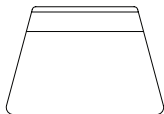
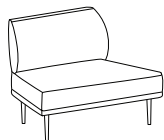

Armless
Open angle ends
Polished aluminum base
Upholstered

All necessary ganging brackets are included and pre-installed

When using a combination of fabrics or leathers, specify the application by designating the appropriate letter, shown below, on the purchase order. Yardage shown must be used.

See terms and conditions for contrasting upholstery upcharges.

- A) One fabric or leather for seat cushion
yardage: 3.5 yds. leather: 57.0 sq. ft.
- B) One fabric or leather for inside back and outside back
yardage: 2.5 yds. leather: 41.0 sq. ft.

SCS Indoor Advantage™ Gold and LEVEL® 2 certified. See terms and conditions for additional environmental information.

Seat Height	Arm Height	W	D	H	Fabric	Leather	Weight	Cubes/Qty
16½"	-	44"	31¼"	29"	4.0 yds.	50.0'	71 lbs.	68.33/1
419 mm	-	1118 mm	794 mm	737 mm	3.7 m	4.6 sqm	32.2 kg	1.93 cu.

COM	COL	1	2	3	4	5	6	7	8	9	10	11
2848	2928	3222	3284	3320	3391	3453	3480	3524	3586	3640	3702	4057

connecting module

mirador 8032C

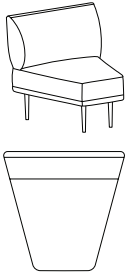

Armless
Closed angle ends
Polished aluminum base
Upholstered

All necessary ganging brackets are included and pre-installed

When using a combination of fabrics or leathers, specify the application by designating the appropriate letter, shown below, on the purchase order. Yardage shown must be used.

See terms and conditions for contrasting upholstery upcharges.

- A) One fabric or leather for seat cushion
yardage: 3.5 yds. leather: 57.0 sq. ft.
- B) One fabric or leather for inside back and outside back
yardage: 2.5 yds. leather: 41.0 sq. ft.

SCS Indoor Advantage™ Gold and LEVEL® 2 certified. See terms and conditions for additional environmental information.

Seat Height	Arm Height	W	D	H	Fabric	Leather	Weight	Cubes/Qty
16½"	-	30"	31¼"	29"	4.0 yds.	50.0'	58 lbs.	22.69/1
419 mm	-	762 mm	794 mm	737 mm	3.7 m	4.6 sqm	26.4 kg	.64 cu.

COM	COL	1	2	3	4	5	6	7	8	9	10	11
2848	2928	3222	3284	3320	3391	3453	3480	3524	3586	3640	3702	4057

mirador 8033A

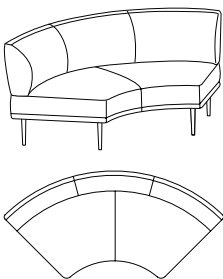

Armless
Closed angle ends
Polished aluminum base
Upholstered

All necessary ganging brackets are included and pre-installed

When using a combination of fabrics or leathers, specify the application by designating the appropriate letter, shown below, on the purchase order. Yardage shown must be used.

See terms and conditions for contrasting upholstery upcharges.

- A) One fabric or leather for seat cushion
yardage: 6.0 yds. leather: 98.0 sq. ft.
- B) One fabric or leather for inside back and outside back
yardage: 6.0 yds. leather: 98.0 sq. ft.

SCS Indoor Advantage™ Gold and LEVEL® 2 certified. See terms and conditions for additional environmental information.

Seat Height	Arm Height	W	D	H	Fabric	Leather	Weight	Cubes/Qty
16½"	-	77"	31¼"	29"	8.5 yds.	120.0'	153 lbs.	80.67/1
419 mm	-	1956 mm	794 mm	737 mm	7.8 m	11.2 sqm	69.5 kg	2.28 cu.

COM	COL	1	2	3	4	5	6	7	8	9	10	11
4978	5148	5772	5904	5980	6131	6263	6320	6414	6546	6660	6792	7547

mirador 8034A

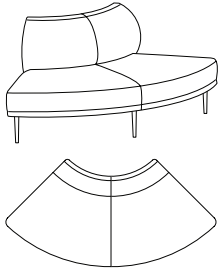

Armless
Open angle ends
Polished aluminum base
Upholstered

All necessary ganging brackets are included and pre-installed

When using a combination of fabrics or leathers, specify the application by designating the appropriate letter, shown below, on the purchase order. Yardage shown must be used.

See terms and conditions for contrasting upholstery upcharges.

- A) One fabric or leather for seat cushion
 yardage: 6.0 yds. leather: 98.0 sq. ft.
- B) One fabric or leather for inside back and outside back
 yardage: 3.0 yds. leather: 50.0 sq. ft.

SCS Indoor Advantage™ Gold and LEVEL® 2 certified. See terms and conditions for additional environmental information.

Seat Height	Arm Height	W	D	H	Fabric	Leather	Weight	Cubes/Qty
16½"	-	73"	31¼"	29"	6.3 yds.	80.0'	135 lbs.	80.67/1
419 mm	-	1854 mm	794 mm	737 mm	5.8 m	7.4 sqm	61.4 kg	2.28 cu.

COM	COL	1	2	3	4	5	6	7	8	9	10	11
4978	5104	5566	5664	5720	5832	5930	5972	6042	6140	6224	6322	6882

mirador 8035A

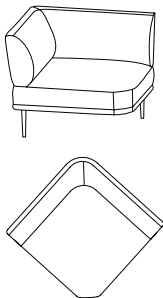

Corner connector
Straight ends
Polished aluminum base
Upholstered

All necessary ganging brackets are included and pre-installed
 May not be used at the end of a configuration or as a freestanding unit

When using a combination of fabrics or leathers, specify the application by designating the appropriate letter, shown below, on the purchase order. Yardage shown must be used.

See terms and conditions for contrasting upholstery upcharges.

- A) One fabric or leather for seat cushion
 yardage: 4.5 yds. leather: 73.0 sq. ft.
- B) One fabric or leather for inside back, outside back and side arms
 yardage: 3.75 yds. leather: 61.0 sq. ft.

SCS Indoor Advantage™ Gold and LEVEL® 2 certified. See terms and conditions for additional environmental information.

Seat Height	Arm Height	W	D	H	Fabric	Leather	Weight	Cubes/Qty
16½"	-	38"	38"	29"	6.0 yds.	98.0'	81 lbs.	32.10/1
419 mm	-	965 mm	965 mm	737 mm	3.7 m	5.6 sqm	36.8 kg	.91 cu.

COM	COL	1	2	3	4	5	6	7	8	9	10	11
3378	3498	3938	4032	4085	4192	4285	4325	4392	4485	4565	4658	5192

freestanding bench

mirador 8040A



**Freestanding bench
Polished aluminum base
Upholstered**

Levelers and non-marring glides

See terms and conditions for contrasting upholstery upcharges.

SCS Indoor Advantage™ Gold and LEVEL® 2 certified. See terms and conditions for additional environmental information.

Seat Height	Arm Height	W	D	H	Fabric	Leather	Weight	Cubes/Qty
16½"	-	30"	28¾"	16½"	3.0 yds	40.0'	55 lbs	22.67/1
419 mm	-	762 mm	730 mm	419 mm	2.7 m	3.7 sqm	25.0 kg	.64 cu

COM	COL	1	2	3	4	5	6	7	8	9	10	11
1606	1666	1886	1933	1960	2013	2060	2080	2113	2160	2200	2246	2513

mirador 8041A

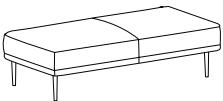

**Two-seat freestanding bench
Polished aluminum base
Upholstered**

Levelers and non-marring glides

SCS Indoor Advantage™ Gold and LEVEL® 2 certified. See terms and conditions for additional environmental information.

Seat Height	Arm Height	W	D	H	Fabric	Leather	Weight	Cubes/Qty
16½"	-	60"	28¾"	16½"	5.5 yds	75.0'	122 lbs	68.33/1
419 mm	-	1524 mm	730 mm	419 mm	5.0 m	7.0 sqm	55.5 kg	1.93 cu

COM	COL	1	2	3	4	5	6	7	8	9	10	11
2493	2603	3007	3092	3141	3239	3325	3361	3422	3508	3581	3667	4156

mirador 8042A

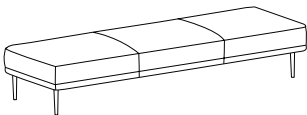

**Three-seat freestanding bench
Polished aluminum base
Upholstered**

Levelers and non-marring glides

SCS Indoor Advantage™ Gold and LEVEL® 2 certified. See terms and conditions for additional environmental information.

Seat Height	Arm Height	W	D	H	Fabric	Leather	Weight	Cubes/Qty
16½"	-	90"	28¾"	16½"	7.5 yds	101.0'	181 lbs	101.65/1
419 mm	-	2286 mm	730 mm	419 mm	6.9 m	9.4 sqm	82.3 kg	2.87 cu

COM	COL	1	2	3	4	5	6	7	8	9	10	11
2670	2820	3370	3487	3554	3687	3804	3854	3937	4054	4154	4270	4937