

cp.4 credenzas  
price list

march 2025

index	2
veneer selections	3-4
design selections + powder coat selections	5
collection overview	6
72" credenzas	7
84" credenzas	8
90" credenzas	9
96" credenzas	10-11
108" credenzas	12-13
120" credenzas	14
tops - glass	15
trash/recycling bin	16
accessories	17
terms and conditions	18-20
guaranteed freight	21
guaranteed freight - canada	22

SCS Indoor Advantage™ Gold and LEVEL® 1 certified. See terms and conditions for additional environmental information.

**Veneer Selections**

A three character sku identifies each species as well as the standard finish offered. Individual components are priced with standard finish. Special finishes on veneers made to customer specifications are subject to factory approval and a 10% net upcharge with a \$500 net minimum.

Transparent stains and sealers are applied in multiple steps to enhance the beauty of the natural wood. A durable, baked-on, top-coat of conversion varnish

or UV topcoat is applied to protect the product. It is recommended that felt, cork or fabric backed desk pads and accessories are used on worksurfaces to minimize wear.

When specifying light finishes the natural characteristics of the wood will be visible and color will vary. Paint finishes are available as custom orders. See terms and conditions for additional finish information.

**ASH** Ash

Rift Cut

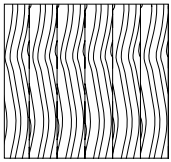

Standard Finish

871 870 839  
837 860 861  
865 836 866  
872 805 845

**ASH** Select Finishes

M73 M72 M75  
M74 M76 M77  
M71

**MPL** Maple

Flat Cut

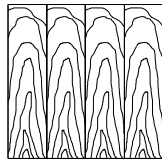

Standard Finish

871 860 861  
837 836 823  
865 805 866  
872 839 845  
870

**OAK** Oak

Rift Cut

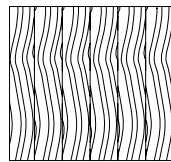

Standard Finish

871 870 839  
837 860 861  
865 836 866  
872 805 845

**OAK** Select Finishes

M73 M72 M75  
M74 M76 M77  
M71

**PLD** Paldao

Quarter Cut

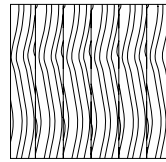

Standard Finish

871 860 823  
872 861 866  
870 839

**WLT** Walnut

Flat Cut

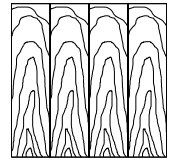

Standard Finish

872 861  
870 823  
860 866  
839

**ASH** Ash



871

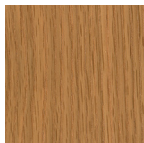

837



865

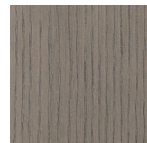

872

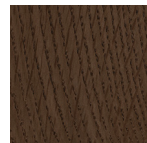

870



860

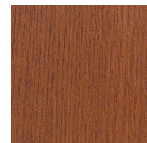

836

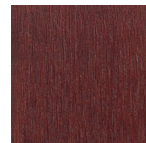

805

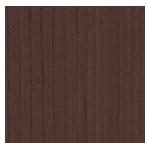

839



861

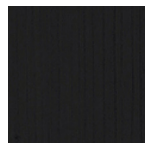

866



845

**ASH** Select Finishes



M73 Whitewash

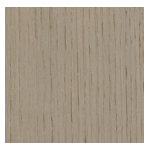

M74 Fawn



M71 Blonde

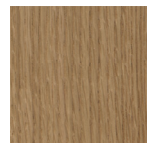

M72 Toast

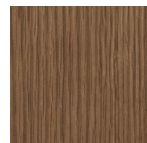

M76 Caramel

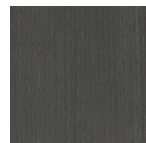

M75 Smoke

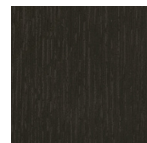

M77 Coffee

**Veneer Selections**

**MPL Maple**



**OAK Oak**

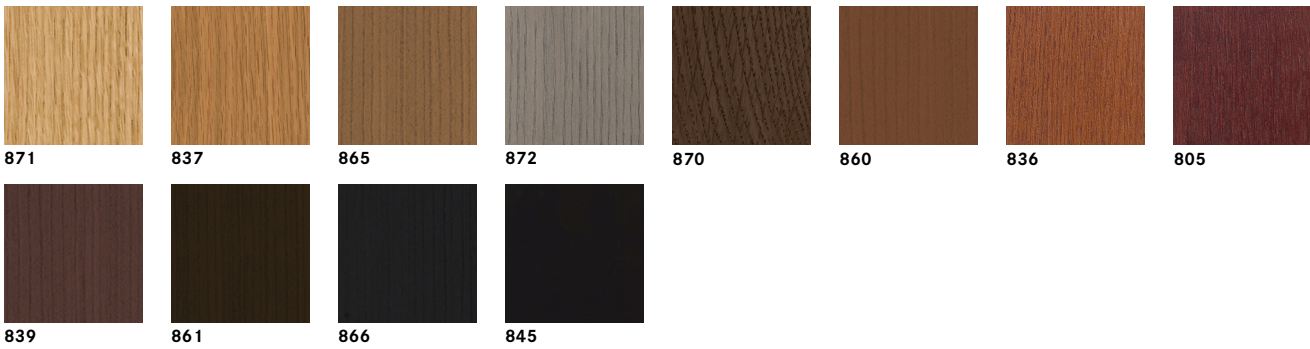

**OAK Select Finishes**



**PLD Paldao**

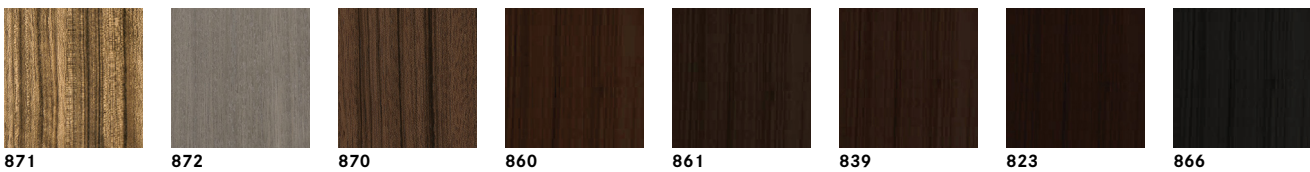

**WLT Walnut**



## Design Selections

### Veneer Selections



**FL** ¾" Flat Edge

### Glass Selections - Tops



**PF** Polished Flat Edge

**GPW** Back-Painted White Glass - ½" thick

**GEW** Etched Back-Painted White Glass - ½" thick

**GEB** Etched Back-Painted Black Glass - ¾" thick

### Finishes

A two character sku identifies each powder coat finish offered. Individual skus are priced with standard metal finish. Non-standard finishes may incur an additional charge. The powder coat option is available on skus where noted as an option in the material specification code.

### Standard Finish



**SS** Polished Stainless Steel

### Powder Coat Finishes - **Upcharges apply.**

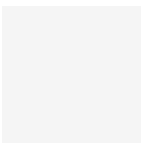

**WH** Satin White

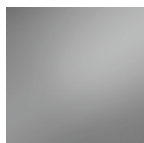

**GR** Graphite

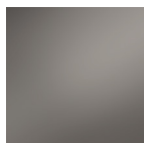

**BZ** Bronze



**IG** Iron Grey



**RD** Black Red



**BK** Matte Black

### Optional Powder Coat Colors - RAL

- Lead Time - Three weeks additional lead-time after color approval
- Net Up-charge - \$1000 for colors shown in Bernhardt Design RAL Powder Coat Selector
- Minimum Order Quantity - None
- Approval Sample Cost - None
- Combining Products - One up-charge is applicable for multiple products on a single purchase order when they are in the same color

### Base Selections

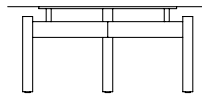

Cp.4 bases are available in polished stainless steel and a variety of powder coat finishes.

### Pull/Hardware Selections

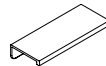

**TB** Black Tab

**TC** Chrome Tab

**TW** Satin White Powder Coat Tab

**TG** Graphite Powder Coat Tab

**TZ** Bronze Powder Coat Tab

**TI** Iron Grey Powder Coat Tab

**TR** Black Red Powder Coat Tab

**Cp.4 Credenzas**

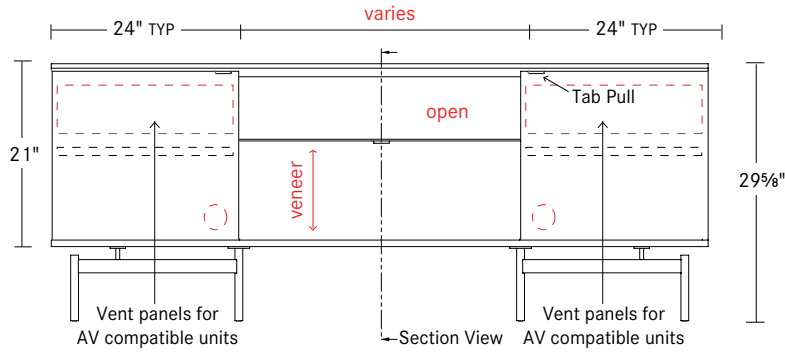

**Front View**

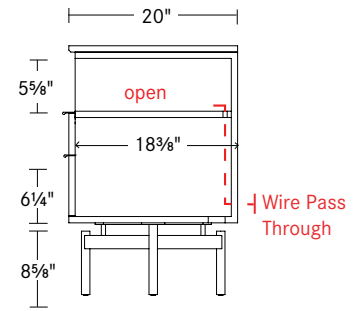

**Section View**

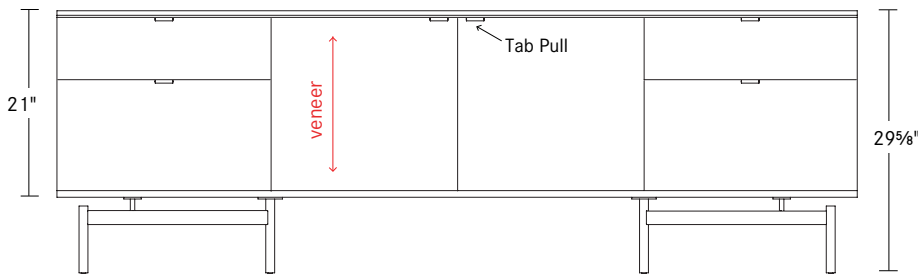

**Front View**

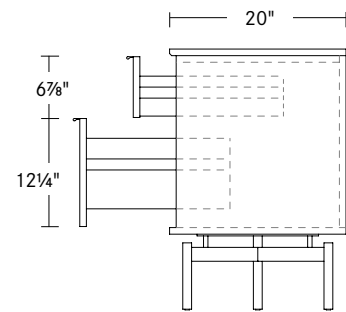

**Side View**

**Trash/Recycling Bin**

Slideout, dual compartment trash/recycling bin  
 Bin ships assembled  
 Includes: (1) open-top 30 liter bin and (1) open-top 19 liter bin  
 Overall size: 16 7/8" w x 18 1/4" d x 17 7/8" h, Gray LLDPE  
 1" square adhesive backed trash and recycled icons included   
 for optional on-site installation.

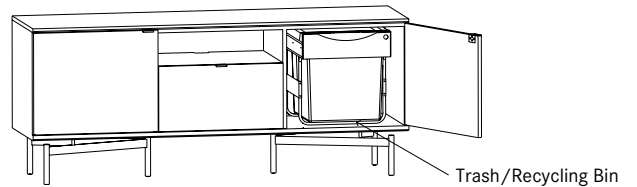

**AV Equipment Rack**

Rack max weight capacity: 200 lbs.  
 Removable AV rack.  
 9 usable rack spaces  
 Usable Depth: 16"  
 Usable Width: 18 1/2"

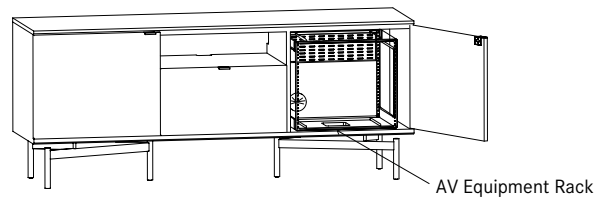

**Glass Detail**

Bernhardt Design offers a glass tops for placement on top of any Cp.4 credenza. A 1/2" thick glass top is offered in back-painted white and etched back-painted white. A 3/8" thick glass top is offered in etched back-painted black glass.

When installing, position the glass top 1/2" from the front and sides, keeping it flush with the back of the credenza.

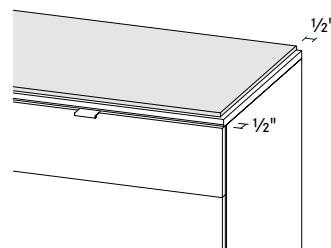



**72" w credenzas**

all storage units come with 1 adjustable shelf.  
 av units come with vent panel.  
 av equipment rack and accessories are specified separately.  
 trash/recycling units are specified separately, install only within 24" storage doors.

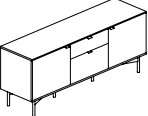
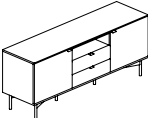
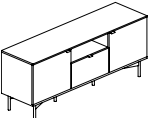
description	sku	w	d	h	ASH ash MPL maple OAK oak WLT walnut	PLD paldao
 <p><b>storage unit</b></p> <p>(1) 24"w storage unit, trash/recycling compatible                      (1) 24"w two-drawer unit, standard and deep storage                      (1) 24"w storage unit, trash/recycling compatible</p>	CCN	72	20	29½	\$ 9936	\$ 11526
<p><b>storage unit with av compatibility</b></p> <p>(1) 24"w av unit with vent panel                      (1) 24"w two-drawer unit, standard and deep storage                      (1) 24"w av unit with vent panel                      select av options below</p>	CCT	72	20	29½	10440	12111
 <p><b>storage unit</b></p> <p>(1) 24"w storage unit, trash/recycling compatible                      (1) 24"w open shelf over standard storage drawers                      (1) 24"w storage unit, trash/recycling compatible                      no av option available</p>	CDN	72	20	29½	10059	11669
 <p><b>storage unit</b></p> <p>(1) 24"w storage unit, trash/recycling compatible                      (1) 24"w open shelf over deep storage drawer                      (1) 24"w storage unit, trash/recycling compatible</p>	CEN	72	20	29½	9936	11526
<p><b>storage unit with av compatibility</b></p> <p>(1) 24"w av unit with vent panel                      (1) 24"w open shelf over deep storage drawer                      (1) 24"w av unit with vent panel                      select av options below</p>	CET	72	20	29½	10440	12111

specification codes example: C4S-SKU-TBVB

material/finish code example: BK MPL 805

series	sku	pull finish	av options	base finish	material	finish
cp.4		TC chrome tab <b>select same finish as base finish</b> TW satin white powder coat tab TG graphite powder coat tab TZ bronze powder coat tab TI iron grey powder coat tab TR black red powder coat tab TB matte black powder coat	VB vents FL fan left <b>upcharge \$426</b> FR fan right <b>upcharge \$426</b> FB fan both <b>upcharge \$850</b> 00 none	PS polished stainless steel <b>powder coat upcharge \$350</b> WH satin white powder coat GR graphite powder coat BZ bronze powder coat IG iron grey powder coat RD black red powder coat BK matte black powder coat	ASH ash MPL maple OAK oak WLT walnut PLD paldao	see pages 3-4
C   4   S   -	-					



**84" w credenzas**

all storage units come with 1 adjustable shelf.  
 av units come with vent panel. av equipment rack and accessories are specified separately.  
 trash/recycling units are specified separately, install only within 24" storage doors.

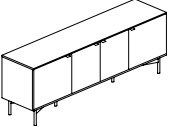
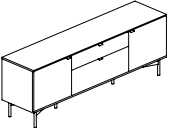
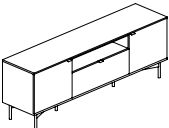
description	sku	w	d	h	ASH ash MPL maple OAK oak WLT walnut	PLD paldao
 <p><b>storage unit</b></p> <p>(1) 24" w storage unit, trash/recycling compatible                      (1) 36" w storage unit                      (1) 24" w storage unit, trash/recycling compatible</p>	CAL	84	20	29½	\$ 10143	\$ 11766
<p><b>storage unit with av compatibility</b></p> <p>(1) 24" w av unit with vent panel                      (1) 36" w storage unit                      (1) 24" w av unit with vent panel                      select av options below</p>	CAU	84	20	29½	10648	12352
 <p><b>storage unit</b></p> <p>(1) 24" w storage unit, trash/recycling compatible                      (1) 36" w two-drawer unit, standard and deep storage                      (1) 24" w storage unit, trash/recycling compatible                      no av option available</p>	CCL	84	20	29½	10143	11766
 <p><b>storage unit</b></p> <p>(1) 24" w storage unit, trash/recycling compatible                      (1) 36" w open shelf over deep storage drawer                      (1) 24" w storage unit, trash/recycling compatible</p>	CEL	84	20	29½	10143	11766
<p><b>storage unit with av compatibility</b></p> <p>(1) 24" w av unit with vent panel                      (1) 36" w open shelf over deep storage drawer                      (1) 24" w av unit with vent panel                      select av options below</p>	CEU	84	20	29½	10648	12352

specification codes example: C4S-SKU-TBVB

material/finish code example: BK MPL 805

series	sku	pull finish	av options	base finish	material	finish
cp.4		TC chrome tab <b>select same finish as base finish</b> TW satin white powder coat tab TG graphite powder coat tab TZ bronze powder coat tab TI iron grey powder coat tab TR black red powder coat tab TB matte black powder coat	VB vents FL fan left <b>upcharge \$426</b> FR fan right <b>upcharge \$426</b> FB fan both <b>upcharge \$850</b> 00 none	PS polished stainless steel <b>powder coat upcharge \$350</b> WH satin white powder coat GR graphite powder coat BZ bronze powder coat IG iron grey powder coat RD black red powder coat BK matte black powder coat	ASH ash MPL maple OAK oak WLT walnut PLD paldao	see pages 3-4
C   4   S   -	-					





**90" w credenzas**

all storage units come with 1 adjustable shelf.  
 av units come with vent panel. av equipment rack and accessories are specified separately.  
 trash/recycling units are specified separately, install only within 24" storage doors.

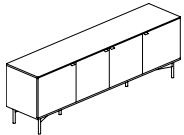

**storage unit**

- (1) 24" w storage unit, trash/recycling compatible
- (2) 21" w storage units
- (1) 24" w storage unit, trash/recycling compatible

**storage unit with av compatibility**

- (1) 24" w av unit with vent panel
- (2) 21" w storage units
- (1) 24" w av unit with vent panel
- select av options below

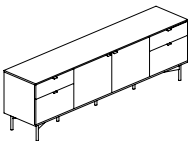

**storage unit**

- (1) 24" w two-drawer unit, standard and deep storage
- (2) 21" w storage units
- (1) 24" w two-drawer unit, standard and deep storage
- no av option available

description	sku	w	d	h	ASH	MPL	OAK	WLT	PLD
					ash	maple	oak	walnut	paldao
<b>storage unit</b>	CAK	90	20	29½	\$ 10348				\$ 12004
(1) 24" w storage unit, trash/recycling compatible (2) 21" w storage units (1) 24" w storage unit, trash/recycling compatible									
<b>storage unit with av compatibility</b>	CAV	90	20	29½	10853				12590
(1) 24" w av unit with vent panel (2) 21" w storage units (1) 24" w av unit with vent panel select av options below									
<b>storage unit</b>	CHK	90	20	29½	10681				12390
(1) 24" w two-drawer unit, standard and deep storage (2) 21" w storage units (1) 24" w two-drawer unit, standard and deep storage no av option available									

specification codes example: C4S-SKU-TBVB

material/finish code example:

BK MPL 805

series	sku	pull finish	av options	base finish	material	finish
cp.4		TC chrome tab <b>select same finish as base finish</b> TW satin white powder coat tab TG graphite powder coat tab TZ bronze powder coat tab TI iron grey powder coat tab TR black red powder coat tab TB matte black powder coat	VB vents FL fan left <b>upcharge \$426</b> FR fan right <b>upcharge \$426</b> FB fan both <b>upcharge \$850</b> 00 none	PS polished stainless steel <b>powder coat upcharge \$350</b> WH satin white powder coat GR graphite powder coat BZ bronze powder coat IG iron grey powder coat RD black red powder coat BK matte black powder coat	ASH ash MPL maple OAK oak WLT walnut PLD paldao	see pages 3-4
C   4   S   -	-					



**96" w credenzas**

all storage units come with 1 adjustable shelf.  
 av units come with vent panel. av equipment rack and accessories are specified separately.  
 trash/recycling units are specified separately, install only within 24" storage doors.

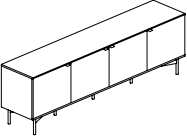
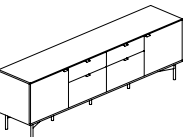
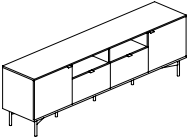
description	sku	w	d	h	ASH ash MPL maple OAK oak WLT walnut	PLD paldao
 <p><b>storage unit</b></p> <p>(4) 24" w storage units, trash/recycling compatible</p>	CAJ	96	20	29½	\$ 11509	\$ 13351
<p><b>storage unit with av compatibility</b></p> <p>(4) 24" w av units with vent panel select av options below</p>	CAW	96	20	29½	12013	13936
 <p><b>storage unit</b></p> <p>(1) 24" w storage unit, trash/recycling compatible                      (2) 24" w two-drawer units, standard and deep storage                      (1) 24" w storage unit, trash/recycling compatible                      no av option available</p>	CCJ	96	20	29½	11509	13351
 <p><b>storage unit</b></p> <p>(1) 24" w storage unit, trash/recycling compatible                      (2) 24" w open shelves over deep storage drawer                      (1) 24" w storage unit, trash/recycling compatible</p>	CEJ	96	20	29½	11509	13351
<p><b>storage unit with av compatibility</b></p> <p>(1) 24" w av unit with vent panel                      (2) 24" w open shelves over deep storage drawers                      (1) 24" w av unit with vent panel                      select av options below</p>	CEW	96	20	29½	12013	13936

specification codes example: C4S-SKU-TBVB

material/finish code example:

BK MPL 805

series	sku	pull finish	av options	base finish	material	finish
cp.4		TC chrome tab <b>select same finish as base finish</b> TW satin white powder coat tab TG graphite powder coat tab TZ bronze powder coat tab TI iron grey powder coat tab TR black red powder coat tab TB matte black powder coat	VB vents FL fan left <b>upcharge \$426</b> FR fan right <b>upcharge \$426</b> FB fan both <b>upcharge \$850</b> 00 none	PS polished stainless steel <b>powder coat upcharge \$350</b> WH satin white powder coat GR graphite powder coat BZ bronze powder coat IG iron grey powder coat RD black red powder coat BK matte black powder coat	ASH ash MPL maple OAK oak WLT walnut PLD paldao	see pages 3-4
C   4   S   -	-					



**96" w credenzas**

all storage units come with 1 adjustable shelf.  
 av units come with vent panel. av equipment rack and accessories are specified separately.  
 trash/recycling units are specified separately, install only within 24" storage doors.

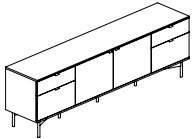

description	sku	w	d	h	ASH	MPL	OAK	WLT	PLD
					ash	maple	oak	walnut	paldo
<b>storage unit</b>	CHJ	96	20	29½	\$ 11716	\$ 13591			
(1) 24" w two-drawer unit, standard and deep storage (2) 24" w storage units (1) 24" w two-drawer unit, standard and deep storage no av option available									

specification codes example: C4S-SKU-TBVB

material/finish code example:

BK MPL 805

series	sku	pull finish	av options	base finish	material	finish
cp.4		TC chrome tab <b>select same finish as base finish</b> TW satin white powder coat tab TG graphite powder coat tab TZ bronze powder coat tab TI iron grey powder coat tab TR black red powder coat tab TB matte black powder coat	VB vents FL fan left <b>upcharge \$426</b> FR fan right <b>upcharge \$426</b> FB fan both <b>upcharge \$850</b> 00 none	PS polished stainless steel <b>powder coat upcharge \$350</b> WH satin white powder coat GR graphite powder coat BZ bronze powder coat IG iron grey powder coat RD black red powder coat BK matte black powder coat	ASH ash MPL maple OAK oak WLT walnut PLD paldao	see pages 3-4
C   4   S   -	-					



**108" w credenzas**

all storage units come with 1 adjustable shelf.  
 av units come with vent panel.  
 av equipment rack and accessories are specified separately.  
 trash/recycling units are specified separately, install only within 24" storage doors.

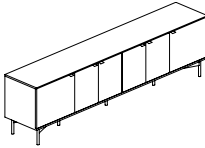
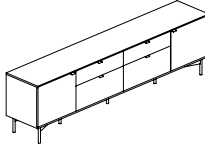
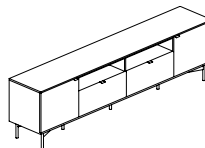
description	sku	w	d	h	ASH ash MPL maple OAK oak WLT walnut	PLD paldao
 <p><b>storage unit</b></p> <p>(1) 24" w storage unit, trash/recycling compatible                      (2) 30" w storage units                      (1) 24" w storage unit, trash/recycling compatible</p>	CAH	108	20	29½	\$ 12046	\$ 13974
<p><b>storage unit with av compatibility</b></p> <p>(1) 24" w av unit with vent panel                      (2) 30" w storage units                      (1) 24" w av unit with vent panel                      select av options below</p>	CAX	108	20	29½	12550	14558
 <p><b>storage unit</b></p> <p>(1) 24" w storage unit                      (2) 30" w two-drawer units, standard and deep storage                      (1) 24" w storage unit                      no av option available</p>	CCH	108	20	29½	12046	13974
 <p><b>storage unit</b></p> <p>(1) 24" w storage unit, trash/recycling compatible                      (2) 30" w open shelves over deep storage drawers                      (1) 24" w storage unit, trash/recycling compatible</p>	CEH	108	20	29½	12046	13974
<p><b>storage unit with av compatibility</b></p> <p>(1) 24" w av unit with vent panel                      (2) 30" w open shelves over deep storage drawers                      (1) 24" w av unit with vent panel                      select av options below</p>	CEX	108	20	29½	12550	14558

specification codes example: C4S-SKU-TBVB

material/finish code example:

BK MPL 805

series	sku	pull finish	av options	base finish	material	finish
cp.4		TC chrome tab <b>select same finish as base finish</b> TW satin white powder coat tab TG graphite powder coat tab TZ bronze powder coat tab TI iron grey powder coat tab TR black red powder coat tab TB matte black powder coat	VB vents FL fan left <b>upcharge \$426</b> FR fan right <b>upcharge \$426</b> FB fan both <b>upcharge \$850</b> 00 none	PS polished stainless steel <b>powder coat upcharge \$350</b> WH satin white powder coat GR graphite powder coat BZ bronze powder coat IG iron grey powder coat RD black red powder coat BK matte black powder coat	ASH ash MPL maple OAK oak WLT walnut PLD paldao	see pages 3-4
C   4   S   -	-					



**108" w credenzas**

all storage units come with 1 adjustable shelf.  
 av units come with vent panel. av equipment rack and accessories are specified separately.  
 trash/recycling units are specified separately, install only within 24" storage doors.

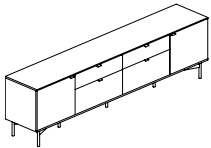

description

sku

w

d

h

ASH ash  
 MPL maple  
 OAK oak  
 WLT walnut

PLD paldao

**storage unit storage unit with av compatibility**

CCX

108

20

29½

\$ 13294

\$ 15422

- (1) 24" w av unit with vent panel
- (2) 30" w two-drawer units, standard and deep storage
- (1) 24" w av unit with vent panel
- select av options below

specification codes example: C4S-SKU-TBVB

material/finish code example:

BK MPL 805

series	sku	pull finish	av options	base finish	material	finish
cp.4		TC chrome tab select same finish as base finish TW satin white powder coat tab TG graphite powder coat tab TZ bronze powder coat tab TI iron grey powder coat tab TR black red powder coat tab TB matte black powder coat	VB vents FL fan left upcharge \$426 FR fan right upcharge \$426 FB fan both upcharge \$850 00 none	PS polished stainless steel powder coat upcharge \$350 WH satin white powder coat GR graphite powder coat BZ bronze powder coat IG iron grey powder coat RD black red powder coat BK matte black powder coat	ASH ash MPL maple OAK oak WLT walnut PLD paldao	see pages 3-4
C   4   S   -	-					

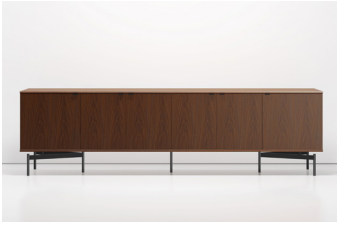

**120" w credenzas**

all storage units come with 1 adjustable shelf.  
 av units come with vent panel. av equipment rack and accessories are specified separately.  
 trash/recycling units are specified separately, install only within 24" storage doors.

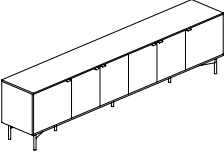
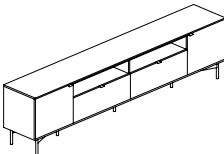
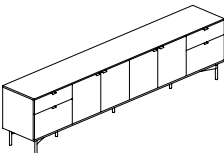
description	sku	w	d	h	ASH ash MPL maple OAK oak WLT walnut	PLD paldao
 <p><b>storage unit</b></p> <p>(1) 24" w storage unit, trash/recycling compatible                      (2) 36" w storage units                      (1) 24" w storage unit, trash/recycling compatible</p>	CAF	120	20	29½	\$ 12832	\$ 14886
<p><b>storage unit with av compatibility</b></p> <p>(1) 24" w av unit with vent panel                      (2) 36" w storage units                      (1) 24" w av unit with vent panel                      select av options below</p>	CAY	120	20	29½	13336	15470
 <p><b>storage unit</b></p> <p>(1) 24" w storage unit, trash/recycling compatible                      (2) 36" w open shelves over deep storage drawers                      (1) 24" w storage unit, trash/recycling compatible</p>	CEF	120	20	29½	12832	14886
<p><b>storage unit with av compatibility</b></p> <p>(1) 24" w av unit with vent panel                      (2) 36" w open shelves over deep storage drawers                      (1) 24" w av unit with vent panel                      select av options below</p>	CEY	120	20	29½	13336	15470
 <p><b>storage unit</b></p> <p>(1) 24" w two-drawer unit, standard and deep storage                      (2) 36" w storage units                      (1) 24" w two-drawer unit, standard and deep storage                      no av option available</p>	CHF	120	20	29½	13057	15147

specification codes example: C4S-SKU-TBVB

material/finish code example:

BK MPL 805

series	sku	pull finish	av options	base finish	material	finish
cp.4		TC chrome tab <b>select same finish as base finish</b> TW satin white powder coat tab TG graphite powder coat tab TZ bronze powder coat tab TI iron grey powder coat tab TR black red powder coat tab TB matte black powder coat	VB vents FL fan left <b>upcharge \$426</b> FR fan right <b>upcharge \$426</b> FB fan both <b>upcharge \$850</b> 00 none	PS polished stainless steel <b>powder coat upcharge \$350</b> WH satin white powder coat GR graphite powder coat BZ bronze powder coat IG iron grey powder coat RD black red powder coat BK matte black powder coat	ASH ash MPL maple OAK oak WLT walnut PLD paldao	see pages 3-4
C   4   S   -	-					



**tops - glass**

position the glass top 1/2" from front and sides keeping it flush with the back of the credenza  
 glass will rest on the surface of the credenza wood top

description	sku	w	d	specifications	GPW	GEW	GEB
					back-painted white glass	etched back-painted white glass	etched back-painted black glass
<b>glass top</b>  1/2" glass top - specify code GPW or GEW 3/8" glass top - specify code GEB	GLN	71	19 1/2	use with 72" credenza	\$ 2564	\$ 3129	\$ 3818
	GLL	83	19 1/2	use with 84" credenza	2967	3620	4417
	GLK	89	19 1/2	use with 90" credenza	3166	3863	4713
	GLJ	95	19 1/2	use with 96" credenza	3366	4107	5011
	GLH	107	19 1/2	use with 108" credenza	3770	4600	5612
	GLF	119	19 1/2	use with 120" credenza	4176	5095	6216



specification codes example: C4S-SKU

series	sku
cp.4	
C   4   S   -	

material/finish code example:

edge
PF polished flat

PF GPW

material
GPW back-painted white glass
GEW etched back-painted white glass
GEB etched back-painted black glass



trash/recycling bin

description	sku	w	d	h	price
<b>trash/recycling bin</b>	T30	16 7/8	18 1/4	17 7/8	\$ 1330

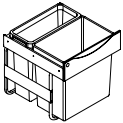



Slideout, dual compartment trash/recycling bin  
 Rack ships assembled  
 Includes: (1) open-top 30 liter bin and (1) open-top 19 liter bin  
 Gray LLDPE  
 1" square adhesive backed trash and recycled icons  
 included for optional on-site installation.



specification codes example: ACS-SKU

series	sku
cp.4	
C   4   S   -	

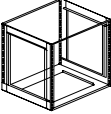
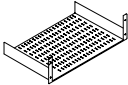
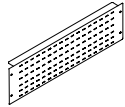
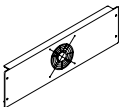
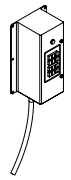

description	sku	w	d	h	specifications	price
 <p><b>av equipment rack</b></p> <p>use with av credenzas install within inside door units only rack max weight capacity: 200 lb. matte black powder coat field assembled and installed specify separately the ACS-VSJ av shelf</p>	VCU	19¼	16	16¾	use with standard height credenzas	\$ 1333
	VCT	19¼	16	22¾	use with serving height credenzas	1996
 <p><b>av shelf</b></p> <p>mounts to rack rails slots for securing components with straps hardware included usable depth: 15½" usable width: 18½" matte black powder coat specify separately the ACS-VCU equipment rack</p>	VSJ	19	15¾	3½	use with standard and serving height credenzas	349
 <p><b>vent panel</b></p> <p>matte black powder coat perforated steel, 64% open included with av units replacement use only</p>	VP1	19	2	5¼		238
 <p><b>fan</b></p> <p>QFAN fan output: 50 CFM 115V, &lt;30dBA matte black powder coat 50" 15A grounded cord</p>	FN2	19	2	5¼	<p><b>Note:</b> Fan runs continuously when plugged in. To regulate temperature, purchase the fan thermostatic switch controller <b>FTS</b>.</p>	493
 <p><b>fan thermostatic switch controller</b></p> <p>(4) outlet for controller thermostatic probe 9' 15A grounded cord</p>	FTS	4	2¾	8½	<p><b>Note:</b> Recommended use with <b>FN2</b> fan unit to regulate temperature.</p>	1011
 <p><b>wire clip kit</b></p> <p>(5) ½" cable clamps (5) ½" large cable holders hardware included</p>	WMP	1⅝	7⁄8	1½		130

specification codes example: ACS-SKU

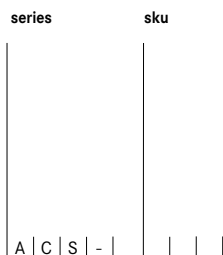

**Prices and Specifications**

Prices and specifications are subject to change without notice. All prices quoted will be FOB our factories. If applicable, sales tax will be based on ship-to destination.

Bernhardt Design reserves the right to make changes in dimensions, construction, price lists, or product literature without prior notice.

All measurements and weights are approximate and subject to change without notice.

**Order Entry**

All orders are subject to final acceptance by Bernhardt Design in Lenoir, NC. Receipt of our acknowledgment indicates acceptance of your order subject to the terms set forth on the acknowledgment.

Bernhardt Design attempts to clarify all purchase orders. However, in the event the price list number and description on the purchase order differ, the price list number will prevail.

**Changes/Cancellation**

All orders in production are considered firm orders and are not subject to changes or cancellation.

**Shipping**

Bernhardt Design will ship in accordance with customer instructions whenever possible. For convenience, Bernhardt Design offers a guaranteed freight program (GFP). Bernhardt Design will exercise our best judgment in selecting a carrier under our GFP. When selecting a carrier, Bernhardt Design will make our best effort to meet requested delivery dates.

Transportation lead-times and delays including equipment problems, weather, general traffic, traffic accidents, customer warehouse space, labor disputes, customer changes, etc., that occur on a carrier will not be the responsibility of Bernhardt Design. Furthermore, Bernhardt Design will not be responsible for additional costs incurred due to aforementioned delays.

For customers who decline our GFP, Bernhardt Design will stage orders for pick up at 1% of the list price, or \$75 minimum.

Customer orders in production will be shipped as scheduled and will not be held. Bernhardt Design reserves the right to make partial shipments on any order, unless notified otherwise by the customer.

High quality cartoning meeting trucking and railroad specifications is standard at no extra charge. Some items may be blanket wrapped for shipment.

**Freight Damage and Claims**

Bernhardt Design is not liable for any damages to products that occur during transit or storage. The carrier assumes all responsibility upon acceptance of product. It is the customer's responsibility to inspect products upon receipt and file any claims with the carrier. No product should be refused. If products are received damaged, a written exception should be made on the bill of lading and an immediate inspection be requested of the carrier.

Concealed damage must be reported to the carrier within 10 business days from date of delivery. Failure to make claims shall constitute acceptance of the products and waiver any claims of defects, errors or shortages.

In the event delivery is made on a Bernhardt Design truck, the products should be carefully inspected for transit damage. If contents are damaged, the driver should be notified to call his dispatcher for immediate disposition.

Concealed damage must be reported within 10 business days from date of delivery and product/package held for inspection by a Bernhardt Design representative. Replacements for product damaged in shipment or storage will be manufactured upon receipt of a purchase order.

**Returns**

No merchandise may be returned to Bernhardt Design without written consent in the form of a Return Authorization from our Quality Assurance Department stating why item is being returned and how item will be shipped.

Unauthorized returns will be automatically refused by our receiving department as well as returns not in accordance with Bernhardt Design shipping instructions. Liability for defective merchandise shall be limited to the replacement or repair of that merchandise, and Bernhardt Design shall not be liable for other damages or losses.

**Terms and Credit**

Pricing and terms of sale apply to orders accepted by Bernhardt Design, and no terms, stipulations, or conditions contained in the dealer's submitted purchase orders shall have any force or effect. Bernhardt Design requires a completed and signed credit application from every dealer. Bernhardt Design also requires dealers to provide a Blanket Certificate of Resale/Use containing valid sales tax exemption number(s) for their respective state(s).

If credit has been approved, the standard terms for all Bernhardt Design products are Net 30 from the invoice date. In certain instances, as an additional condition of order acceptance, buyer may be required to provide a deposit at time of order and/or remit the balance before shipment is released. If credit has not been approved, a 100% prepayment, including any freight charges, is required prior to production.

Acceptable forms of payment include a certified check or electronic bank transfer. For information on where to send check/electronic bank information contact our Financial Services Department. If a dealer or company check is submitted, three (3) weeks should be allowed for the clearance of the check. If electronic bank transfer is submitted, one (1) week should be allowed for the clearance of the electronic bank transfer. The order is subject to cancellation if payment in full is not received within three (3) weeks from the acknowledgment date.

The dealer may not make deductions for advertising, promotions, quality problems, freight, or any other reason without prior authorization by Bernhardt Design. Such a deduction could result in the curtailment or suspension of further shipments until the matter is resolved. Delinquency notices are generated and mailed periodically. Service charges of 18% per annum will be added to each past-due transaction. Unpaid service charges

will be accrued and invoiced on a periodic basis. Past-due notices may result in orders being held until the situation is resolved. This credit hold could prevent orders from being placed into production or shipped. Orders not in production that are placed on credit hold for three (3) weeks will be subject to cancellation.

Severe past-due situations may result in the employment of a collection agency or other collection litigation. If any collection activity is necessary regarding a dealer account, the dealer will be responsible for the payment of any and all attorney and collection agency fees.

A slow payment history may result in reducing or eliminating an open line of credit. At the discretion of Bernhardt Design, amounts owed by a dealer to Bernhardt Design arising from any transaction or dealings between the dealer and Bernhardt Design may be offset against any amounts owed to the dealer by Bernhardt Design.

### Warranty

Bernhardt Design will repair or replace, at its discretion, any product or part thereof which fails as the result of defects in material and workmanship, under single shift use and normal care for five years from date of shipment. This warranty shall apply only to the original purchaser.

This warranty does not cover normal wear and tear, misuse or abuse of product, dramatic temperature changes, exposure to unusual conditions or damages incurred by contact with seating products, tables, desks or other surfaces. Natural color changes, variations or movements in lumber or veneer products, exposure to extreme temperature changes and direct sunlight may cause color changes and/or surface damage. These are circumstances beyond the control of Bernhardt Design and are not warranty issues. Repair or replacement of discontinued product will be at the discretion of Bernhardt Design.

This warranty is the customer's exclusive remedy for product defect and does not apply to damage caused by a freight carrier, dealer, installer, user modification, attachments to a product, or any third party. Bernhardt Design has the exclusive right to make the final determination of product misuse or abuse. Except as stated above, Bernhardt Design makes no express or implied warranties as to any product, and in particular, makes no warranty of merchant ability or of fitness for any particular purpose. Bernhardt Design shall not be liable for any consequential or incidental damages or for commercial loss arising from any product defect.

### Operational Parts Warranty

Drawer glides, drawer boxes, drawer pulls, and lock mechanisms have a Life-Time Warranty for original purchaser. Power and communication components are warranted for one year.

### Parts Order

Bernhardt Design parts have a \$25 net minimum per order. This does not include freight costs.

### Custom Design

Bernhardt Design may alter products to meet specific needs. Contact your local sales representative when a custom design is needed. Custom designs,

**if approved**, require minimum quantities, additional leadtime and upcharges. A custom job number, available from your Bernhardt Design sales representative, must be submitted with purchase orders.

Orders combining custom design with standard product cannot be scheduled for production until custom items are approved. Custom design orders are not subject to revision or cancellation after acknowledgment.

### Wood Finishes

Bernhardt Design tables are available in finishes that are compatible with credenzas and seating finishes. However, finishes on tables may vary slightly from those on seating due to the natural characteristics of the wood. No absolute match is implied or guaranteed.

### Light Finishes

Bernhardt Design offers lighter finishes on certain veneers and solid woods. When specifying light finishes the natural characteristics of the wood will be visible and color will vary.

Natural characteristics include the natural discolorations of the wood substance and color variations in glued up stock. These natural characteristics are not considered defects by Bernhardt Design, and therefore merchandise will not be replaced.

### Special Finishes

Special finishes, made to customer specifications and subject to factory approval, may be available at a **10% net upcharge with a \$500 net minimum**.

Additional leadtime may be required for special finish items. Special finish orders will not be acknowledged until the special finish sample is approved in writing and received by Bernhardt Design Customer Service. Special finish orders are not subject to revision or cancellation after acknowledgment.

### Installation and Maintenance

All freestanding tables and credenzas are equipped with leveling devices. Local floor conditions vary, and it is always necessary to properly adjust leveling devices. Proper leveling is essential to the alignment and function of doors and drawers.

Improperly leveled units result in misaligned doors and drawers and may impair locking mechanisms or other functional hardware.

After the initial installation of credenzas, it may be necessary to readjust and align the units to compensate for settling. This should be expected as a matter of routine maintenance and follow-up to assure proper case function.

Proper installation of Bernhardt Design tables and credenzas is the responsibility of the dealer. Improperly installed units can result in permanent damage to case components. Damage due to improperly installed furniture not covered under product warranty.

Orders combining custom design with standard product cannot be scheduled for production until custom items are approved. Custom design orders are not subject to revision or cancellation after acknowledgment.

**Care and Cleaning**

Finished wood surfaces should be cleaned with a soft damp cloth, wiping in the direction of the grain. Furniture should be buffed dry immediately with a soft cloth.

**Design and Patent Rights**

All of the products shown in Bernhardt Design catalogs and described in Bernhardt Design price lists are, and remain, the property of Bernhardt Design, with the sole right reserved to manufacture and to distribute.

Some of the product designs shown are patented in the United States and will remain the property of Bernhardt Design. Any reproduction of the products constitutes an infringement of patented copyright laws and will be subject to prosecution.

**Environmental**

Some tables and credenzas are LEVEL® for ANSI/BIFMA e3-2019 – Furniture Sustainability Standard and SCS Indoor Advantage™ Gold certified. Visit the product page at [bernhardtdesign.com](http://bernhardtdesign.com) for certifications.

**Preferred Carrier Guaranteed Freight Rates**

Freight charges will be applied to orders as a separate line item based on the zones listed. Rates are based on zones with a minimum for each zone. All zones are located within the Continental United States.

The freight amount is calculated on the total merchandise list COM price. Additional freight fuel surcharges may apply. Rates are based on deliveries made Monday through Friday, 8 am until 5 pm.

All orders are shipped by Bernhardt Design company trucks or preferred carriers specified by Bernhardt Design. **If a purchase order does not specify that the product must ship complete, Bernhardt Design reserves the right to select the most effective shipping method necessary, including split shipments.** Dealer warehouse information, including phone number and contact name, must be specified on the purchase order.

Zone	Percent	Minimum
Zone 1	3%	\$150
Zone 2	4%	\$150
Zone 3	5%	\$150
Zone 4	5.5%	\$150
Zone 5	6%	\$150

Percent bases on List Price.

Direct site deliveries may be requested with an additional freight cost. Requests for direct site deliveries must be made 2 weeks prior to the scheduled ship week and meet the following criteria:

- Minimum of half truckload
- Delivery site accessible by a 53' trailer
- Complete delivery site address with contact name and on-site phone number
- Labor available for unloading

Deliveries that do not meet the criteria must be directed to a receiver warehouse. If a receiver warehouse is not available, the dealer may make arrangements with their own 3rd party carrier. If a 3rd party carrier is elected, a contact name, phone number and e-mail address is required.

Bernhardt Design has a no touch freight policy. Drivers are not allowed to unload freight.

Weekend direct site deliveries will incur a \$500 per trailer weekend delivery fee. Weekend is defined as between 5 pm Friday and 8 am Monday.

Customers who decline GFP should refer to the shipping section of the Terms and Conditions page.

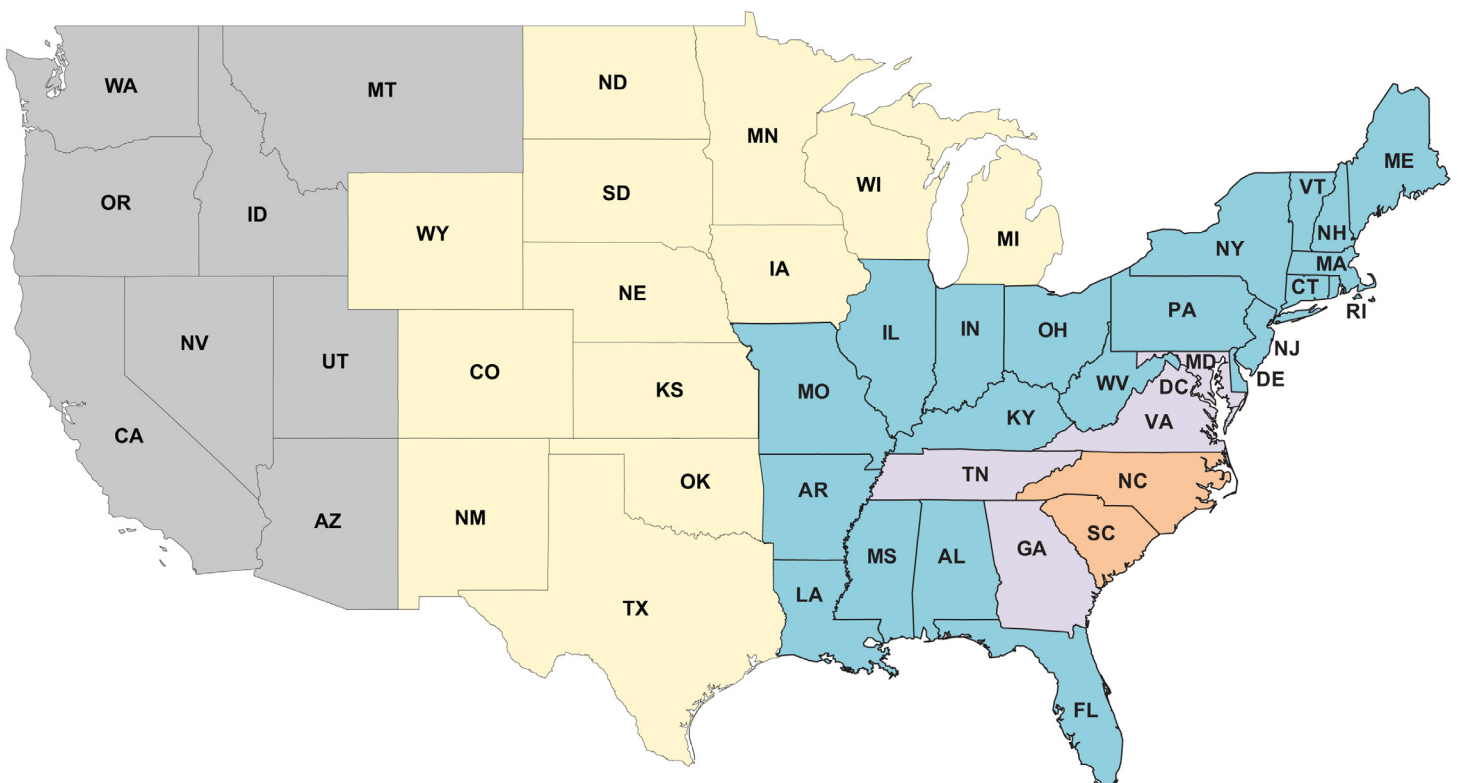

**Preferred Carrier Guaranteed Freight Rates - Canada**

Freight charges will be applied to orders as a separate line item based on the zones listed. Rates are based on zones with a minimum for each zone.

The freight amount is calculated on the total merchandise list COM price. Additional freight fuel surcharges may apply. Rates are based on deliveries made Monday through Friday, 8 am until 5 pm.

All orders are shipped by Bernhardt Design company trucks or preferred carriers specified by Bernhardt Design. If a purchase order does not specify that the product must ship complete, Bernhardt Design reserves the right to select the most effective shipping method necessary, including split shipments. Dealer warehouse information, including phone number and contact name, must be specified on the purchase order.

Direct site deliveries may be requested with an additional freight cost. Requests for direct site deliveries must be made 2 weeks prior to the scheduled ship week and meet the following criteria:

- Minimum of half truckload
- Delivery site accessible by a 53' trailer
- Complete delivery site address with contact name and on-site phone number
- Labor available for unloading

Deliveries that do not meet the criteria must be directed to a receiver warehouse. If a receiver warehouse is not available, the dealer may make arrangements with their own 3rd party carrier. If a 3rd party carrier is elected, a contact name, phone number and e-mail address is required.

Bernhardt Design has a no touch freight policy. Drivers are not allowed to unload freight.

Weekend direct site deliveries will incur a \$500 per trailer weekend delivery fee. Weekend is defined as between 5 pm Friday and 8 am Monday.

Customers who decline GFP should refer to the shipping section of the Terms and Conditions page.

Zone	Minimums	Freight	Avg. Bus. Days
Zone 1	\$200	5%	10-15
Zone 2	\$200	9%	10-15
Zone 3	\$200	8%	10-15
Zone 4	\$200	11%	10-15
Zone 5	Quote	Quote	

The attached rates are strictly freight and do not include brokerage fees.

