

## Casino Seating System Specification Guide

Casino is a modular seating product comprised of eleven unique modules which may be used interchangeably to create an unlimited number of configurations. All Casino configurations must include an end module on each end of the configuration. To select the modules that are appropriate for your application use the guide below.

When ordering multi-item configurations, please provide the total COM yardage from the same dye lot in a continuous roll(s).

### Product Selection

#### A. End Modules

All Casino configurations must include an end module on each end of the configuration.

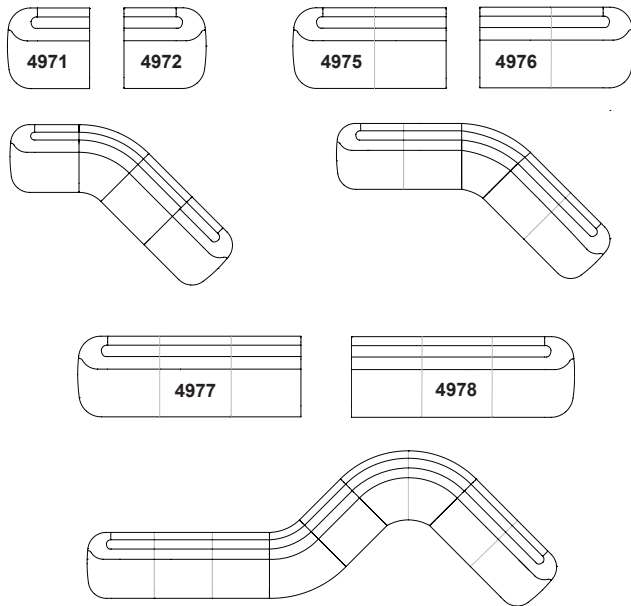

#### C. 90° Connecting Modules

Connecting modules are used in conjunction with end modules. 90° connecting modules may not be used at the end of a configuration or as a freestanding unit.

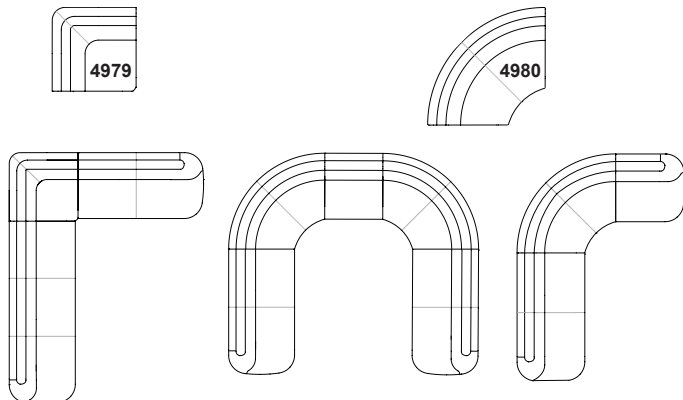

Casino is fully upholstered with leveling non-marring glides. All necessary ganging brackets are included and pre-installed.\*All COM/ COL fabrics must be preapproved by Bernhardt Design prior to application. SCS Indoor Advantage™ Gold and LEVEL® 2 certified. See terms and conditions for badditional environmental information

Please visit Bernhardtdesign.com for a complete library of 2D, 3D and Revit models. You may also contact your local sales representative or the Bernhardt Design corporate office for specification assistance.

#### B. 45° Connecting Modules

Connecting modules are used in conjunction with end modules. 45° connecting modules may not be used at the end of a configuration or as a freestanding unit.

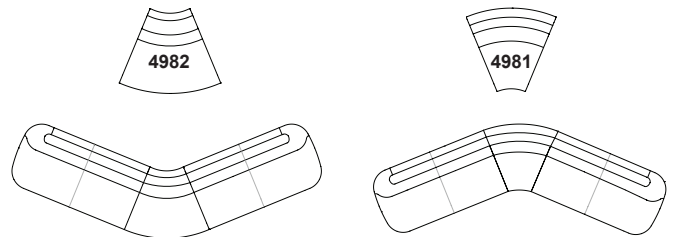

#### D. Straight Connecting Module

Connecting modules are used in conjunction with end modules. Straight connecting modules may not be used at the end of a configuration or as a freestanding unit.

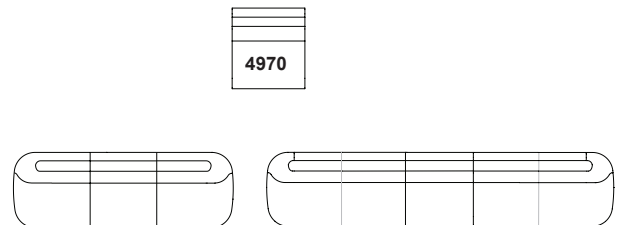

---

Casino Seating System Overview

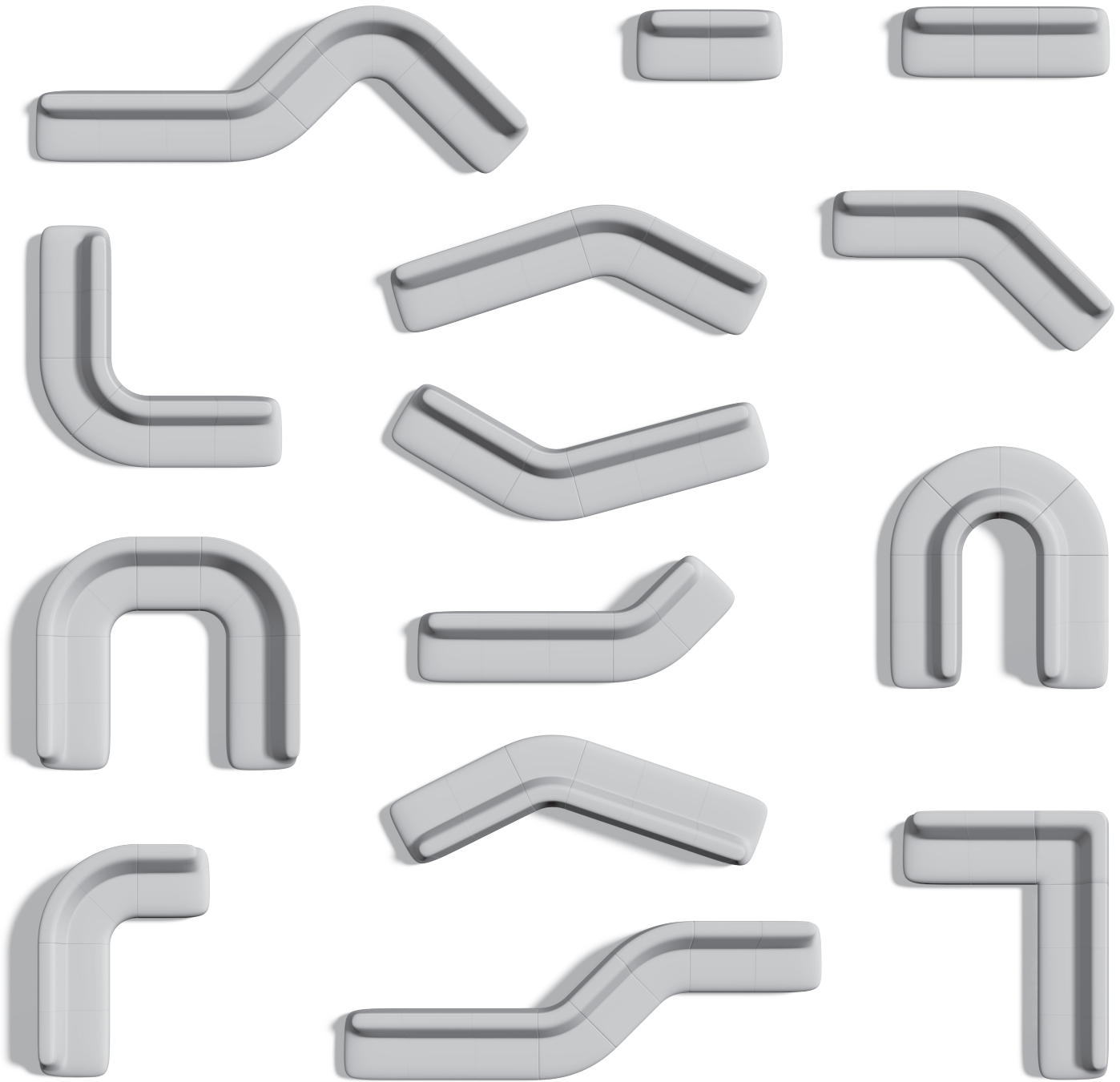

Casino Seating System Sample Configurations

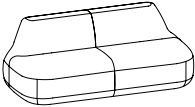
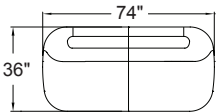
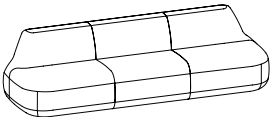
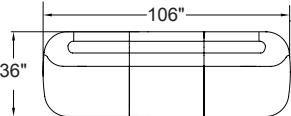
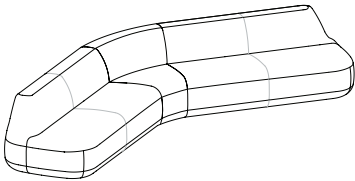
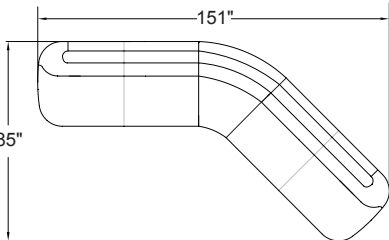
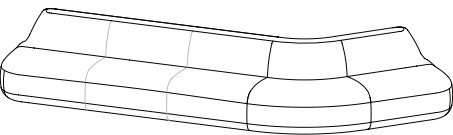
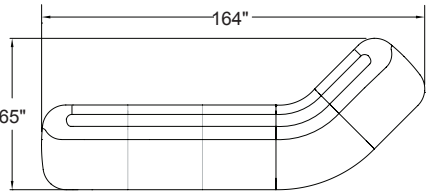
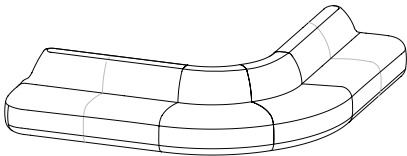
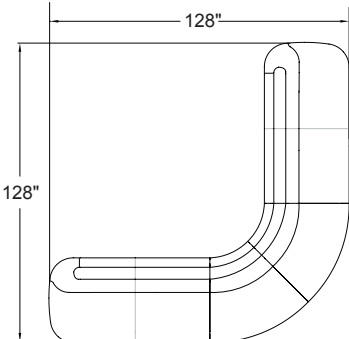
		Skus	Description
1	 	<b>4971</b> <b>4972</b>	Left End Facing Module Right End Facing Module
2	 	<b>4971</b> <b>4970</b> <b>4972</b>	Left End Facing Module Straight Connector Right End Facing Module
3	 	<b>4975</b> <b>4981</b> <b>4976</b>	Two-seater, Left End Facing Module 45° Curved Connector Two-seater, Right End Facing Module
4	 	<b>4977</b> <b>4982</b> <b>4972</b>	Three-seater, Left End Facing Module 45° Inverted Curved Connector Right End Facing Module
5	 	<b>4975</b> <b>4982</b> <b>4976</b>	Two-seater, Left End Facing Module 45° Inverted Curved Connector (2) Two-seater, Right End Facing Module

Casino Seating System Sample Configurations

6		<p><b>4977</b> Three-seat, Left End Facing Module  <b>4982</b> 45° Inverted Curved Connector  <b>4976</b> Two-seat, Right End Facing Module</p>
7		<p><b>4977</b> Three-seat, Left End Facing Module  <b>4981</b> 45° Curved Connector  <b>4976</b> Two-seat, Right End Facing Module</p>
8		<p><b>4975</b> Two-seat, Left End Facing Module  <b>4982</b> 45° Inverted Curved Connector  <b>4978</b> Three-seat, Right End Facing Module</p>
9		<p><b>4975</b> Two-seat, Left End Facing Module  <b>4979</b> Square Corner Connector  <b>4978</b> Three-seat, Right End Facing Module</p>
10		<p><b>4975</b> Two-seat, Left End Facing Module  <b>4980</b> 90° Curved Connector  <b>4970</b> Single Straight Connector  <b>4980</b> 90° Curved Connector  <b>4976</b> Two-seat, Right End Facing Module</p>

Casino Seating System Sample Configurations

SKU Description

11

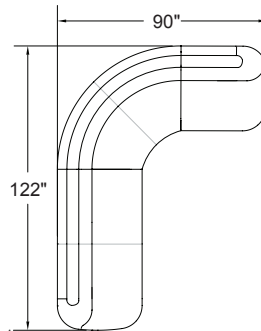
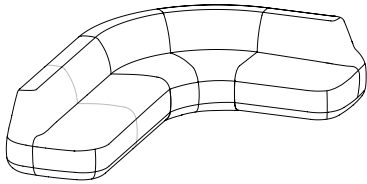

- 4975** Two-seat, Left End Facing Module
- 4980** 90° Curved Connector
- 4972** Right End Facing Module

12

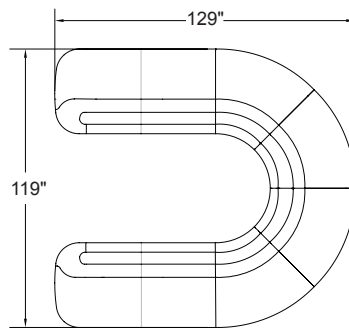
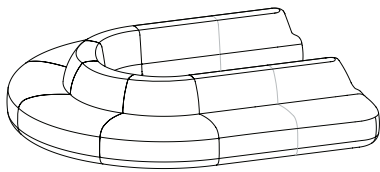

- 4976** Two-seat, Right End Facing Module
- 4982** 45° Inverted Curved Connector (4)
- 4975** Two-seat, Left End Facing Module

13

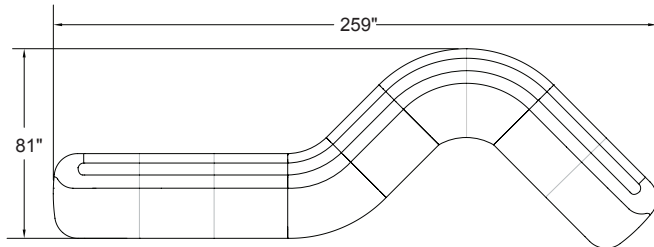
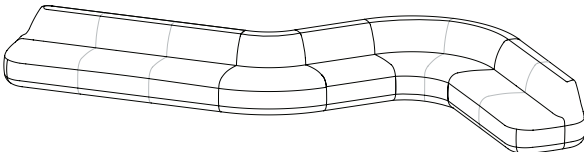

- 4977** Three-seat, Left End Facing Module
- 4982** 45° Inverted Curved Connector
- 4970** Single Straight Connector
- 4980** 90° Curved Connector
- 4976** Two-seat, Right End Facing Module

14

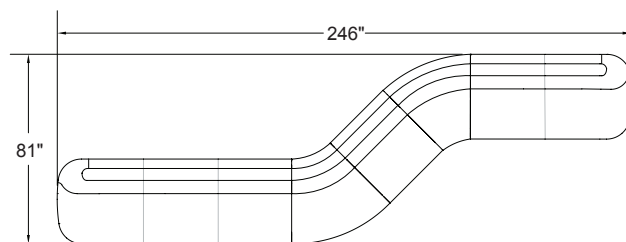
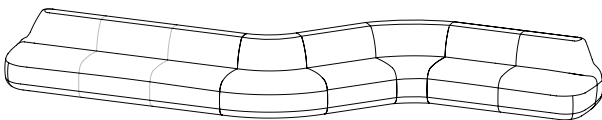

- 4977** Three-seat, Left End Facing Module
- 4982** 45° Inverted Curved Connector
- 4970** Single Straight Connector
- 4981** 45° Curved Connector
- 4976** Two-seat, Right End Facing Module

**casino 4971**

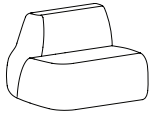

**Left end facing module  
Fully upholstered**

All necessary ganging brackets are included and pre-installed

SCS Indoor Advantage™ Gold and LEVEL® 2 certified. See terms and conditions for additional environmental information.

Seat Height	Arm Height	W	D	H	Fabric	Leather	Weight	Cubes/Qty
17"	-	37"	36¼"	28¼"	6.0 yds.	100.0'	90 lbs.	32.10'/1
432 mm	-	940 mm	921 mm	718 mm	5.5 m	9.3 sqm	40.8 kg	0.91 cu.

COM	COL	1	2	3	4	5	6	7	8	9	10	11
2418	2538	2978	3072	3125	3232	3325	3365	3432	3525	3605	3698	4232

**casino 4972**

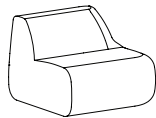

**Right end facing module  
Fully upholstered**

All necessary ganging brackets are included and pre-installed

SCS Indoor Advantage™ Gold and LEVEL® 2 certified. See terms and conditions for additional environmental information.

Seat Height	Arm Height	W	D	H	Fabric	Leather	Weight	Cubes/Qty
17"	-	37"	36¼"	28¼"	6.0 yds.	100.0'	90 lbs.	32.10'/1
432 mm	-	940 mm	921 mm	718 mm	5.5 m	9.3 sqm	40.8 kg	0.91 cu.

COM	COL	1	2	3	4	5	6	7	8	9	10	11
2418	2538	2978	3072	3125	3232	3325	3365	3432	3525	3605	3698	4232

**casino 4975**

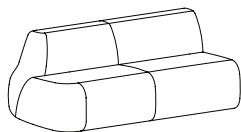

**Two-seat  
Left end facing  
Fully upholstered module**

All necessary ganging brackets are included and pre-installed

SCS Indoor Advantage™ Gold and LEVEL® 2 certified. See terms and conditions for additional environmental information.

Seat Height	Arm Height	W	D	H	Fabric	Leather	Weight	Cubes/Qty
17"	-	69"	36¼"	28¼"	8.5 yds.	138.0'	145 lbs.	80.67'/1
432 mm	-	1753 mm	921 mm	718 mm	7.8 m	12.8 sqm	65.7 kg	2.28 cu.

COM	COL	1	2	3	4	5	6	7	8	9	10	11
4186	4356	4980	5112	5188	5339	5471	5528	5622	5754	5868	6000	6755

**casino 4976**

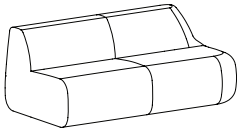

**Two-seat  
Right end facing module  
Fully upholstered**

All necessary ganging brackets are included and pre-installed

SCS Indoor Advantage™ Gold and LEVEL® 2 certified. See terms and conditions for additional environmental information.

Seat Height	Arm Height	W	D	H	Fabric	Leather	Weight	Cubes/Qty
17"	-	69"	36¼"	28¼"	8.5 yds.	138.0'	145 lbs.	80.67/1
432 mm	-	1753 mm	921 mm	718 mm	7.8 m	12.8 sqm	65.7 kg	2.28 cu.

COM	COL	1	2	3	4	5	6	7	8	9	10	11
4186	4356	4980	5112	5188	5339	5471	5528	5622	5754	5868	6000	6755

**casino 4977**

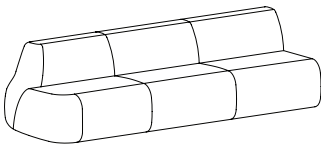

**Three-seat  
Left end facing module  
Fully upholstered**

All necessary ganging brackets are included and pre-installed

SCS Indoor Advantage™ Gold and LEVEL® 2 certified. See terms and conditions for additional environmental information.

Seat Height	Arm Height	W	D	H	Fabric	Leather	Weight	Cubes/Qty
17"	-	100½"	36¼"	28¼"	12.25 yds.	200.0'	220 lbs.	97.97/1
432 mm	-	2553 mm	921 mm	718 mm	11.2 m	18.6 sqm	99.8 kg	2.77 cu.

COM	COL	1	2	3	4	5	6	7	8	9	10	11
5312	5557	6456	6646	6755	6973	7164	7245	7381	7572	7735	7926	9015

**casino 4978**

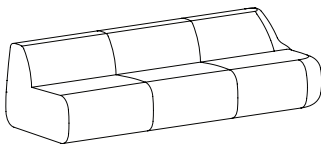

**Three-seat  
Right end facing module  
Fully upholstered**

All necessary ganging brackets are included and pre-installed

SCS Indoor Advantage™ Gold and LEVEL® 2 certified. See terms and conditions for additional environmental information.

Seat Height	Arm Height	W	D	H	Fabric	Leather	Weight	Cubes/Qty
17"	-	100½"	36¼"	28¼"	12.25 yds.	200.0'	220 lbs.	97.97/1
432 mm	-	2553 mm	921 mm	718 mm	11.2 m	18.6 sqm	99.8 kg	2.77 cu.

COM	COL	1	2	3	4	5	6	7	8	9	10	11
5312	5557	6456	6646	6755	6973	7164	7245	7381	7572	7735	7926	9015

**casino 4970**

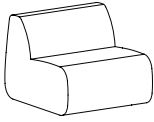

**Straight connector  
Fully upholstered**

All necessary ganging brackets are included and pre-installed

SCS Indoor Advantage™ Gold and LEVEL® 2 certified. See terms and conditions for additional environmental information.

Seat Height	Arm Height	W	D	H	Fabric	Leather	Weight	Cubes/Qty
17"	-	32¾"	36¼"	28¼"	5.3 yds.	100.0'	76 lbs.	32.10'/1
432 mm	-	832 mm	921 mm	718 mm	4.8 m	9.3 sqm	34.5 kg	0.91 cu.

COM	COL	1	2	3	4	5	6	7	8	9	10	11
2097	2203	2592	2675	2722	2816	2898	2934	2993	3075	3146	3228	3699

**casino 4979**

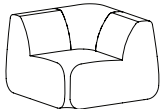

**Corner connector  
Fully upholstered**

All necessary ganging brackets are included and pre-installed

SCS Indoor Advantage™ Gold and LEVEL® 2 certified. See terms and conditions for additional environmental information.

Seat Height	Arm Height	W	D	H	Fabric	Leather	Weight	Cubes/Qty
17"	-	37¾"	37¾"	28¼"	6.7 yds.	120.0'	113 lbs.	32.10'/1
432 mm	-	959 mm	959 mm	718 mm	6.1 m	11.1 sqm	51.3 kg	0.91 cu.

COM	COL	1	2	3	4	5	6	7	8	9	10	11
2899	3033	3525	3629	3689	3808	3912	3957	4031	4135	4225	4329	4924

**casino 4980**



**90° Curved connector  
Fully upholstered**

All necessary ganging brackets are included and pre-installed

SCS Indoor Advantage™ Gold and LEVEL® 2 certified. See terms and conditions for additional environmental information.

Seat Height	Arm Height	W	D	H	Fabric	Leather	Weight	Cubes/Qty
17"	-	74½"	41¼"	28¼"	8.0 yds.	130.0'	95 lbs.	47.67'/1
432 mm	-	1892 mm	1048 mm	718 mm	7.3 m	12.1 sqm	43.1 kg	1.35 cu.

COM	COL	1	2	3	4	5	6	7	8	9	10	11
4186	4346	4933	5058	5129	5271	5395	5449	5538	5662	5769	5893	6604



**casino 4981**

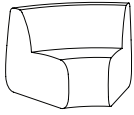

**45° Curved connector  
FullC upholstered**

All necessary ganging brackets are included and pre-installed

SCS Indoor Advantage™ Gold and LEVEL® 2 certified. See terms and conditions for additional environmental information.

Seat Height	Arm Height	W	D	H	Fabric	Leather	Weight	Cubes/Qty
17"	-	40"	37 <sup>5</sup> / <sub>8</sub> "	28 <sup>1</sup> / <sub>4</sub> "	5.3 yds.	100.0'	84 lbs.	32.10'/1
432 mm	-	1016 mm	956 mm	718 mm	4.8 m	9.3 sqm	38.1 kg	0.91 cu.

COM	COL	1	2	3	4	5	6	7	8	9	10	11
2418	2524	2913	2996	3043	3137	3219	3255	3314	3396	3467	3549	4020

**casino 4982**

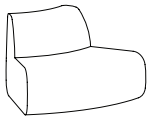

**45° Inverted curved connector  
Fully upholstered**

All necessary ganging brackets are included and pre-installed

SCS Indoor Advantage™ Gold and LEVEL® 2 certified. See terms and conditions for additional environmental information.

Seat Height	Arm Height	W	D	H	Fabric	Leather	Weight	Cubes/Qty
17"	-	45 <sup>1</sup> / <sub>4</sub> "	38 <sup>5</sup> / <sub>8</sub> "	28 <sup>1</sup> / <sub>4</sub> "	5.5 yds.	100.0'	80 lbs.	48.16'/1
432 mm	-	1162 mm	973 mm	718 mm	5.0 m	9.3 sqm	36.3 kg	1.37 cu.

COM	COL	1	2	3	4	5	6	7	8	9	10	11
2418	2528	2932	3017	3066	3164	3250	3286	3347	3433	3506	3592	4081