

Haven Laptop Table



The Haven laptop tables are designed to function as an adjustable height worksurface that features an easy to use but discrete activation handle. Due to it's wide range of adjustability the work surface can be raised or lowered to suit virtually any application.

Bases are available with a plate or x-base design. They are fitted with low-friction glides which allow the tables to easily glide across all surfaces.

All table tops are available in solid and woodgrain laminates, oak and walnut solids, solid surface and PureClad selections. The Haven bases are available in polished aluminum and powder coat finishes.

A three character sku identifies each finish and material selection.

Haven tables are SCS Indoor Advantage™ Gold and LEVEL® 2 certified.

Top Material Selections

PureClad Selections

PureClad is a highly durable powder coat process for tops that creates an encapsulated hardened finish. When PureClad finishes are selected along with their matching metal powder coat finishes for the base, the tables have a monolithic color look.

Edge Profile



PCD PureClad

PureClad option is available on skus where noted as an option in the material specification code.

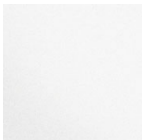

TWH Textured Satin White

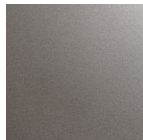

TBZ Textured Bronze

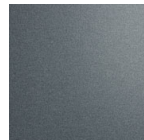

TIG Textured Iron Grey

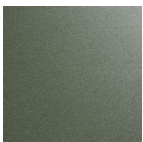

TSG Textured Sage

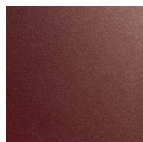

TBR Textured Black Red

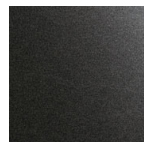

TBK Textured Matte Black



PureClad is a highly durable powder coat process for tops that creates an encapsulated hardened finish that allow the tables to have a monolithic color look.

Laminate Selections

Edge Profile



Individual components are priced with standard finish on standard laminate.

Additional colors may be available but are subject to upcharges and extended lead times. The laminate option is available on components where noted as an option in the material specification code.

PLL Solid Laminate

Standard Solid

- 671 Designer White, Wilsonart D354-60 Matte Finish
- 672 Frosty White, Wilsonart 1573-60 Matte Finish
- 673 Fashion Grey, Wilsonart D381-60 Matte Finish
- 674 North Sea, Wilsonart D90-60 Matte Finish
- 675 Black, Wilsonart 1595-60 Matte Finish

20% Upcharge

- 665 Snow White Velvet, Wilsonart 15501-31 Traceless Laminate
- 666 Charcoal Velvet, Wilsonart 15504-31 Traceless Laminate
- 667 Black Velvet, Wilsonart 15505-31 Traceless Laminate

WGL Woodgrain Laminate

Standard Woodgrain

- 684 Phantom Pearl, Wilsonart 8211K-28 Gloss Line Finish
w/Aeon Scratch Resistant Protection
- 685 Raw Chestnut, Wilsonart 7975K-12 Soft Grain Finish
w/Aeon Scratch Resistant Protection
- 686 High Line, Wilsonart 7970K-18 Linearity Finish
w/Aeon Scratch Resistant Protection
- 678 New Age Oak, Wilsonart 7938-16 Casual Rustic Finish
- 679 Brazilwood, Wilsonart 7946-38 Matte Finish
- 687 Broadwalk Oak, Wilsonart 7983-38 Fine Velvet Finish
- 683 Portico Teak (Grey), Wilsonart 8210K-28 Gloss Line Finish
- 681 Studio Teak, Wilsonart 7960-16 Casual Rustic Finish
- 680 Walnut Heights, Wilsonart 7965K-12 Soft Grain Finish
- 682 Asian Night, Wilsonart 7949-16 Casual Rustic Finish

Top Material Selections

Solid Wood Selections

Edge Profile



When specifying light finishes the natural characteristics of the wood will be visible and color will vary. Therefore, exact color matches are not possible.

Oak Oak
Solid Top - Rift Cut

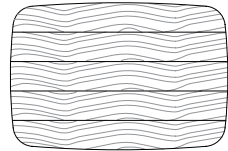

Standard Finish
871 870 839
837 860 861
865 836 866
872 805 845

WLT Walnut
Solid Top - Flat Cut

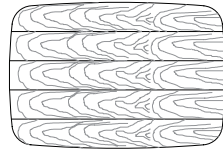

Standard Finish
872 861
870 823
860 866
839

OAK Select Finishes

M73 M72 M75
M74 M76 M77
M71

Solid Surface Selections

Edge Profile



PHL Phenolic

MWF Bianco Kos, Fenix ntm J0032, Matte White Finish

TCB Calcutta Blanc, Wilsonart TS501 THINSCAPE

MBF Nero Ingo, Fenix ntm J0720, Matte Black Finish

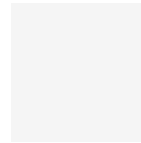

MWF

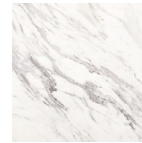

TCB



MBF

Base Material Selections

Powder Coat Finishes

A two character sku identifies each powder coat finish offered. Individual skus are priced with standard metal finish. Non standard finishes may incur an additional charge. The powder coat option is available on skus where noted as an option in the material specification code.

Standard Finish

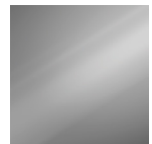

PA Polished Aluminum

Powder Coat Options (Base Only) - upcharge applies

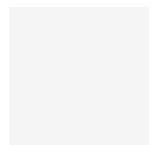

WH Satin White

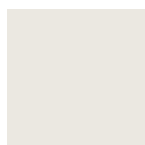

EC Ecu



LA Latte



AL Matte Aluminum



GR Graphite

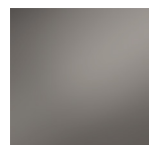

BZ Bronze



SG Sage



IG Iron Grey



RD Black Red



BK Matte Black

Haven Features

The Haven collection features two bases, a plate base and a x-base, which are fitted with low-friction glides that allow the tables to easily glide across all surfaces. Bases are available in polished aluminum and standard powder coat colors.

Tabletops are a spacious 21" x 14" and are available in laminate, solid wood, phenolic and PureClad finishes.

Underneath the tabletop, a custom black handle has been designed to activate a gas lift. Tops can be adjusted from 22" – 32", allowing for flexibility in height.



Release Handle

Plate Base Table and Dimensions

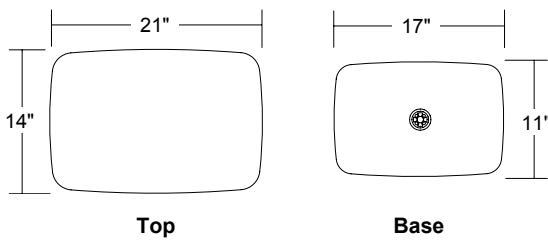
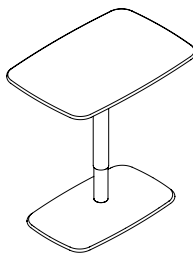

Top

Base

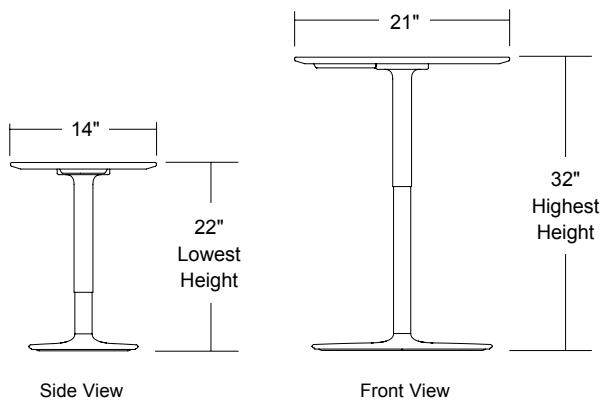

Side View

Front View

X-Base Table and Dimensions

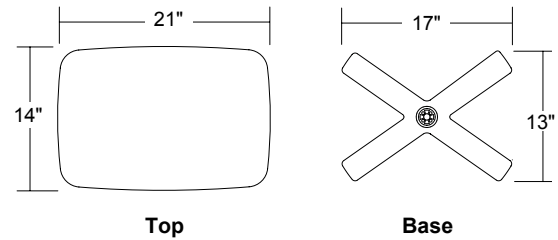
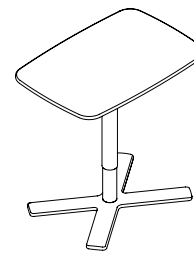

Top

Base

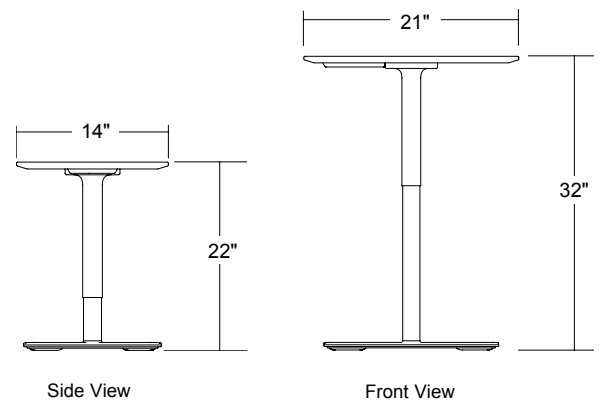



Side View

Front View



Laptop Tables

Adjustable height plate base or x-base tables
 Custom black activation handle to activate the gas lift
 All tables ship with low-friction glides

						PCD PureClad	PLL solid laminate WGL woodgrain laminate	PHL phenolic	OAK solid oak WLT solid walnut
description	sku	w	d	h	weight				
 plate base	RBC	21	14	22-32	0	\$ 1100	\$ 1200	\$ 1450	\$ 1750
 x-base	XBC	21	14	22-32	0	1100	1200	1450	1750

series	sku	base finish	top material	top finish
haven		PA polished aluminum powder coat upcharge \$100 see haven powder coat finishes	PCD PureClad PLL solid laminate WGL woodgrain laminate PHL phenolic OAK solid oak WLT solid walnut	see haven top finishes
H V S -	-	-	-	