

solem
price list

january 2025

Laminate Selections

A three character sku identifies each laminate selection as well as the standard finish offered. Individual components are priced with standard finish on standard laminate.

A variety of Wilsonart® standard laminates with standard finishes is offered on conference and multipurpose tables. Additional colors may be available but are

subject to upcharges and extended lead times. The laminate option is available on components where noted as an option in the material specification code.

All laminate tops will have a 3mm matching edge band.

PLL Solid Laminate

Standard Solid

- 671 Designer White, Wilsonart D354-60 Matte Finish
- 672 Frosty White, Wilsonart 1573-60 Matte Finish
- 673 Fashion Grey, Wilsonart D381-60 Matte Finish
- 674 North Sea, Wilsonart D90-60 Matte Finish
- 675 Black, Wilsonart 1595-60 Matte Finish

20% Upcharge

- 665 Snow White Velvet, Wilsonart 15501-31 Traceless Laminate
- 666 Charcoal Velvet, Wilsonart 15504-31 Traceless Laminate
- 667 Black Velvet, Wilsonart 15505-31 Traceless Laminate

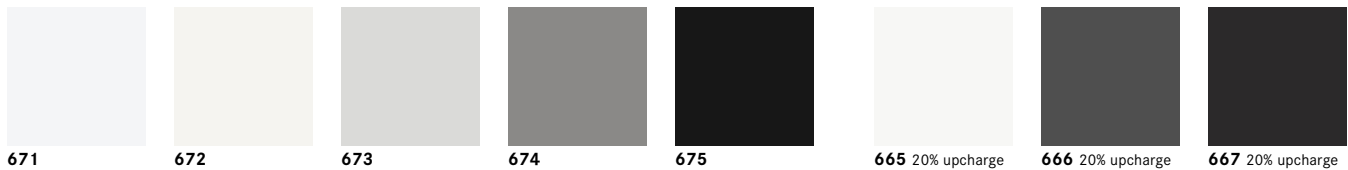

PLL Exposed Plywood

- 701 Black Laminate
- 702 White Laminate

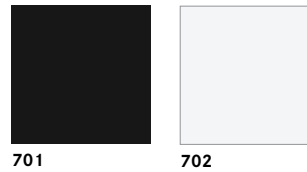

WGL Woodgrain Laminate

Standard Woodgrain

- 684 Phantom Pearl, Wilsonart 8211K-28 Gloss Line Finish w/Aeon Scratch Resistant Protection
- 685 Raw Chestnut, Wilsonart 7975K-12 Soft Grain Finish w/Aeon Scratch Resistant Protection
- 686 High Line, Wilsonart 7970K-18 Linearity Finish w/Aeon Scratch Resistant Protection
- 678 New Age Oak, Wilsonart 7938-16 Casual Rustic Finish
- 679 Brazilwood, Wilsonart 7946-38 Matte Finish
- 687 Boardwalk Oak, Wilsonart 7983-38 Fine Velvet Finish
- 683 Portico Teak (Grey), Wilsonart 8210K-28 Gloss Line Finish
- 681 Studio Teak, Wilsonart 7960-16 Casual Rustic Finish
- 680 Walnut Heights, Wilsonart 7965K-12 Soft Grain Finish
- 682 Asian Night, Wilsonart 7949-16 Casual Rustic Finish



Veneer Selections

A three character sku identifies each species as well as the standard finish offered. Individual components are priced with standard finish. Special finishes on veneers made to customer specifications are subject to factory approval and a 10% net upcharge with a \$500 net minimum.

Transparent stains and sealers are applied in multiple steps to enhance the beauty of the natural wood. A durable, baked-on, top-coat of conversion varnish

or UV topcoat is applied to protect the product. It is recommended that felt, cork or fabric backed desk pads and accessories are used on worksurfaces to minimize wear.

When specifying light finishes the natural characteristics of the wood will be visible and color will vary. Paint finishes are available as custom orders. See terms and conditions for additional finish information.

OAK Oak

Rift Cut

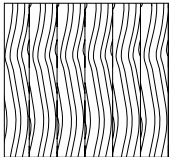

Standard Finish

- 871 870 839
- 837 860 861
- 865 836 866
- 872 805 845

OAK Select Finishes

- M73 M72 M75
- M74 M76 M77
- M71

OAK Oak



- 871
- 837
- 865
- 872
- 870
- 860
- 836
- 805

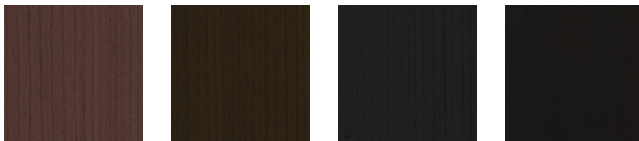

- 839
- 861
- 866
- 845

OAK Select Finishes



- M73 Whitewash
- M74 Fawn
- M71 Blonde
- M72 Toast
- M76 Caramel
- M75 Smoke
- M77 Coffee

Solem

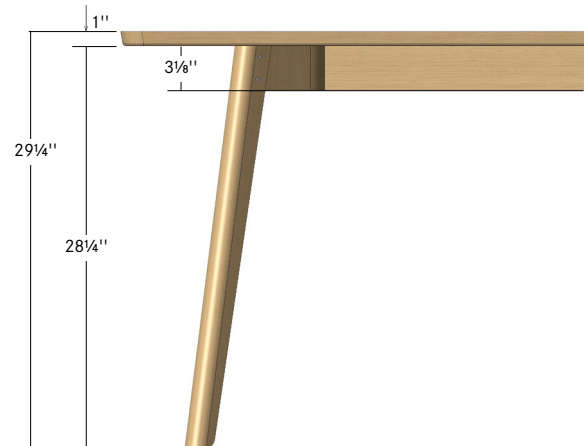

Side View

The Solem table collection features a range of table sizes from café tables to medium scale meeting tables. Tables are offered in a variety of sizes and shapes, ranging from 36" square and 42" round to 48" x 108" rectangle. See specific top size for the appropriate base sku.

Solem bases are constructed from bent plywood with rift cut white oak veneer faces. Table legs are tapered and feature a press formed U-channel allowing the user to conceal wires while creating a unique wire management system.

Power modules, with and without USB, are available to address the needs for power at the top. A dark gray pressed felt wire manager runs in the channel of the leg to hide excess wires. Power module kits are specified separately. A dark gray pressed felt wire manager is included for every power module in the specified kit. Additional wire managers may also be specified separately.

Optional formed metal tray mounts between the long rails under the top to manage excess wires or equipment. Specify tray separately. Field installed.

Solem tops and bases are specified separately.



Detail view of felt wire manager



Solem table shown with wire management tray in center position on left and in end position on right. Field installed.

specification codes example: SMS-SKU

series	sku
solem	
S M S -	-

material + finish code example: OAK 839

base	finish
OAK oak	see page 3

Solem



Solem features a range of table sizes from café tables to medium scale meeting tables. Tables are offered in 36", 42", 48" square and 42", 48" round tops along with rectangular tops beginning at 60" and increasing every 6" to a maximum length of 108". Base sku determined by top size selected.

Tops are available in laminates or oak veneer. Edge details are top specific: flat vinyl edge with plain/abstract or woodgrain laminate, exposed plywood reverse beveled edge with 701 black or 702 white laminate, and solid oak reverse beveled edge with oak veneer. Veneer direction will run the length of the tops.

Optional power modules, with and without USB, are available to address the needs for power at the top. Specify power placement when ordering top. Power module kits are specified separately. A dark gray pressed felt wire manager is included for every power module in the specified kit. Additional wire managers may also be specified separately.

Solem tops and bases are specified separately.

Laminates



- PLL** Solid Laminate
- WGL** Woodgrain Laminate

A variety of standard laminate finishes are available. Additional laminate colors may be available but are subject to upcharges and extended lead times. All laminate tops will have a 3mm matching edge band.

Laminate / Exposed Plywood

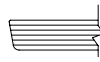
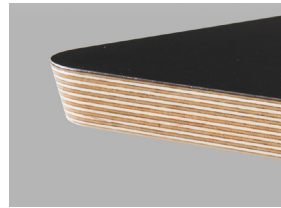

- PLL** Exposed Plywood

Available with 701 - black laminate or 702 - white laminate top with exposed plywood edge with a clear coat natural finish. Specify edge code ES and laminate code PLL.

Veneer

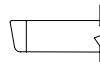

- OAK** Oak
Rift Cut

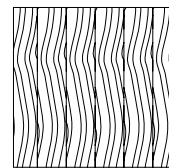

specification codes example: SMS-SKU-FS000

series	sku	edge	power module location
solem		FS flat laminate ES exposed plywood RS reversed bevel	OS1 one end OS2 both ends OS3 center 000 none
S M S -	-		

material + finish code example: PLL 666

top	finish
PLL solid laminate WGL woodgrain laminate OAK oak	see pages 2-3

Round Surface Power Module Kits



The round surface power module is a simple and clean way of bringing power and USB to the top. The round surface power module installs flush to the top and can be specified with: (2) grounded outlets or (1) 15 amp receptacle, (1) 2 amp USB-A port and (1) 2 amp USB-C port ideal for charging tablets or other USB friendly devices.

The round surface power module is UL approved with spill-proof technology. A 15 amp 10' cord and one wire manager per module are included with each kit.

Round Surface Power Module - Power

- (2) 120v 60 Hz. 15 amp
- 10' cord, UL approved
- 4"w x 3 3/8"d x 3 3/8"h
- Specify power style **PP**

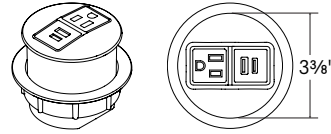

Round Surface Power Module - Power + usb

- (1) 120v 60 Hz. 15 amp
- (1) 2 amp USB-A port, 10 watt
- (1) 2 amp USB-C port, 20 watt
- 10' cord, UL approved
- 4"w x 3 3/8"d x 3 3/8"h
- Specify power style **PU**

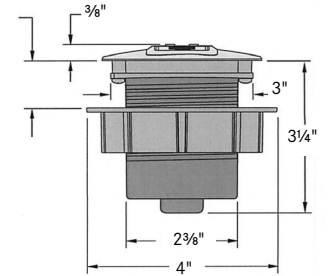
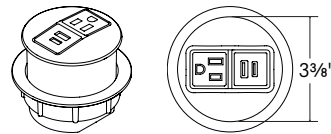

Max. Top
Thickness 1.5"

Power Styles	
PP	PU
(2) 120v 60 Hz. 15 amp	(1) 120v 60 Hz. 15 amp (1) 2 amp USB-A port (1) 2 amp USB-C port

sku specifications

OS3 Center Placement - Round and Square Tables

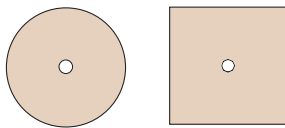

Includes one wire manager

OS1 One End Placement - Rectangular Tables

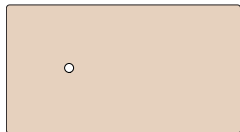

Grommet placement for:
36" wide tables - 20" from end
42" wide tables - 21" from end
48" wide tables - 22" from end
Includes one wire manager

OS2 Both Ends Placement - Rectangular Tables

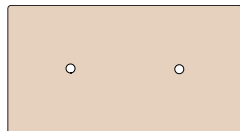

Grommet placement for:
36" wide tables - 20" from end
42" wide tables - 21" from end
48" wide tables - 22" from end
Includes two wire managers

\$ 893 \$ 1012

893 1012

1785 2023

specification codes example: ACS-SKU-PP

series	sku	power style
accessories		PP power PU power + usb
A C S -	-	

finish code example: WH

finish
WH white
BN brushed nickel
BK black



42" and 48" round tables

specify top and base separately
 edge detail for tops are top material specific
 solid and woodgrain laminate: flat edge with vinyl trim; specify PLL or WGL material code and edge code FS
 laminate/exposed plywood: reverse bevel with natural finish; specify PLL material code with 701 black or 702 white finish code
 oak veneer: solid oak edge with reverse bevel; specify OAK material code
 specify optional power module location when ordering top
 power style is specified separately

	description	sku	l	w	h	specifications	price	
round tops 	laminata	CLB	42	42	1	use with BAG base	\$ 1456	
		CLC	48	48	1	use with BAG base	1494	
		specify flat edge code FS specify material code PLL or WGL						
	laminata/exposed plywood	CPB	42	42	1	use with BAG base	1779	
		CPC	48	48	1	use with BAG base	1857	
		reverse bevel edge specify edge code ES for exposed edge specify material code PLL specify finish code 701 for black laminate or 702 for white laminate						
	oak	CWB	42	42	1	use with BAG base	2741	
		CWC	48	48	1	use with BAG base	2982	
	reverse bevel edge specify edge code RS specify material code OAK							

specification codes example: SMS-SKU-FS000

series	sku	edge	power module location
solem		FS flat laminate ES exposed plywood RS reversed bevel	0S3 center 000 none
S M S -	-		

material + finish code example: PLL 666

top	top finish
PLL solid laminate WGL woodgrain laminate OAK oak	see pages 2-3

	description	sku	l	w	h	price
base 	use with CLB, CLC, CPB, CPC, CWB, CWC tops	BAG	31¼	31¼	28¼	\$2297

specification codes example: SMS-BAG

series	sku
solem	
S M S -	B A G





material + finish code example: OAK 839

base	base finish
OAK oak	see page 3

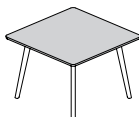

36" square tables

specify top and base separately
 edge detail for tops are top material specific
 solid and woodgrain laminate: flat edge with vinyl trim; specify PLL or WGL material code and edge code FS
 laminate/exposed plywood: reverse bevel with natural finish; specify PLL material code with 701 black or 702 white finish code
 oak veneer: solid oak edge with reverse bevel; specify OAK material code
 specify optional power module location when ordering top
 power style is specified separately

	description	sku	l	w	h	specifications	price
square tops 	laminata specify flat edge code FS specify material code PLL or WGL 	CLA	36	36	1	use with BAG base	\$ 1293
	laminata/exposed plywood reverse bevel edge specify edge code ES for exposed edge specify material code PLL specify finish code 701 for black laminate or 702 for white laminate 	CPA	36	36	1	use with BAG base	1372
	oak reverse bevel edge specify edge code RS specify material code OAK 	CWA	36	36	1	use with BAG base	2177

specification codes example: SMS-SKU-FS000

series	sku	edge	power module location
solem		FS flat laminate ES exposed plywood RS reversed bevel	OS3 center 000 none
S M S -	-		

material + finish code example: PLL 666

top	top finish
PLL solid laminate WGL woodgrain laminate OAK oak	see pages 2-3

	description	sku	l	w	h	price
base 	use with CLA, CPA, CWA tops	BAG	31¾	31¾	28¼	\$ 2297

specification codes example: SMS-BAG

series	sku
solem	
S M S -	B A G





material + finish code example: OAK 839

base	base finish
OAK oak	see page 3

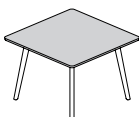

42" square table

specify top and base separately
 edge detail for tops are top material specific
 solid and woodgrain laminate: flat edge with vinyl trim; specify PLL or WGL material code and edge code FS
 laminate/exposed plywood: reverse bevel with natural finish; specify PLL material code with 701 black or 702 white finish code
 oak veneer: solid oak edge with reverse bevel; specify OAK material code
 specify optional power module location when ordering top
 power style is specified separately

	description	sku	l	w	h	specifications	price
square tops 	laminata specify flat edge code FS specify material code PLL or WGL 	SLB	42	42	1	use with BAH base	\$ 1494
	laminata/exposed plywood reverse bevel edge specify edge code ES for exposed edge specify material code PLL specify finish code 701 for black laminate or 702 for white laminate 	SPB	42	42	1	use with BAH base	1935
	oak reverse bevel edge specify edge code RS specify material code OAK 	SWB	42	42	1	use with BAH base	2741

specification codes example: SMS-SKU-FS000

series	sku	edge	power module location
solem		FS flat laminate ES exposed plywood RS reversed bevel	OS3 center 000 none
S M S -	-		

material + finish code example: PLL 666

top	top finish
PLL solid laminate WGL woodgrain laminate OAK oak	see pages 2-3

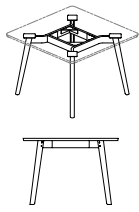
	description	sku	l	w	h	price
base 	use with SLB, SPB, SWB tops	BAH	36	36	28¼	\$ 2297

specification codes example: SMS-BAH

series	sku
solem	
S M S -	B A H





material + finish code example: OAK 839

base	base finish
OAK oak	

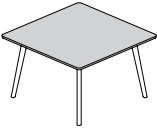

48" square table

specify top and base separately
 edge detail for tops are top material specific
 solid and woodgrain laminate: flat edge with vinyl trim; specify PLL or WGL material code and edge code FS
 laminate/exposed plywood: reverse bevel with natural finish; specify PLL material code with 701 black or 702 white finish code
 oak veneer: solid oak edge with reverse bevel; specify OAK material code
 specify optional power module location when ordering top
 power style is specified separately



	description	sku	l	w	h	specifications	price
square tops 	laminated specify flat edge code FS specify material code PLL or WGL 	SLC	48	48	1	use with BAI base	\$ 1533
	laminated/exposed plywood reverse bevel edge specify edge code ES for exposed edge specify material code PLL specify finish code 701 for black laminate or 702 for white laminate 	SPC	48	48	1	use with BAI base	1857
	oak reverse bevel edge specify edge code RS specify material code OAKK 	SWC	48	48	1	use with BAI base	2982

specification codes example: SMS-SKU-FS000

series	sku	edge	power module location
solem		FS flat laminate ES exposed plywood RS reversed bevel	OS3 center 000 none
S M S -	-		

material + finish code example: PLL 666

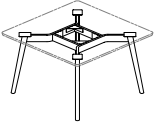
top	top finish
PLL solid laminate WGL woodgrain laminate OAK oak	see pages 2-3

	description	sku	l	w	h	price
base  	use with SLC, SPC, SWC tops	BAI	42	42	28¼	\$ 2297

specification codes example: SMS-BAI

series	sku
solem	
S M S -	B A I

material + finish code example: OAK 839

base	base finish
OAK oak	



36" x 60" rectangular table

specify top and base separately
 edge detail for tops are top material specific
 solid and woodgrain laminate: flat edge with vinyl trim; specify PLL or WGL material code and edge code FS
 laminate/exposed plywood: reverse bevel with natural finish; specify PLL material code with 701 black or 702 white finish code
 oak veneer: solid oak edge with reverse bevel; specify OAK material code
 specify optional power module location when ordering top
 power style is specified separately

	description	sku	l	w	h	specifications	price
rectangular tops 	laminated specify flat edge code FS specify material code PLL or WGL 	RLA	60	36	1	use with BAJ base	\$ 1935
	laminated/exposed plywood reverse bevel edge specify edge code ES for exposed edge specify material code PLL specify finish code 701 for black laminate or 702 for white laminate 	RPA	60	36	1	use with BAJ base	2220
	oak reverse bevel edge specify edge code RS specify material code OAK 	RWA	60	36	1	use with BAJ base	3624

specification codes example: SMS-SKU-FS000

series	sku	edge	power module location
solem		FS flat laminate ES exposed plywood RS reversed bevel	OS1 one end OS2 both ends 000 none
S M S -	-		

material + finish code example: PLL 666

top	top finish
PLL solid laminate WGL woodgrain laminate OAK oak	see pages 2-3

	description	sku	l	w	h	price
base 	use with RLA, RPA, RWA tops	BAJ	54	31¾	28¼	\$ 2578

specification codes example: SMS-BAJ

series	sku
solem	
S M S -	B A J





material + finish code example: OAK 839

base	base finish
OAK oak	

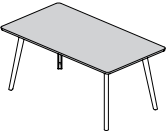

36" x 66" rectangular table

specify top and base separately
 edge detail for tops are top material specific
 solid and woodgrain laminate: flat edge with vinyl trim; specify PLL or WGL material code and edge code FS
 laminate/exposed plywood: reverse bevel with natural finish; specify PLL material code with 701 black or 702 white finish code
 oak veneer: solid oak edge with reverse bevel; specify OAK material code
 specify optional power module location when ordering top
 power style is specified separately

	description	sku	l	w	h	specifications	price
rectangular tops 	laminata specify flat edge code FS specify material code PLL or WGL 	RLB	66	36	1	use with BAK base	\$ 2018
	laminata/exposed plywood reverse bevel edge specify edge code ES for exposed edge specify material code PLL specify finish code 701 for black laminate or 702 for white laminate 	RPB	66	36	1	use with BAK base	2460
	oak reverse bevel edge specify edge code RS specify material code OAK 	RWB	66	36	1	use with BAK base	3788

specification codes example: SMS-SKU-FS000

series	sku	edge	power module location
solem		FS flat laminate ES exposed plywood RS reversed bevel	OS1 one end OS2 both ends 000 none
S M S -	-		

material + finish code example: PLL 666

top	top finish
PLL solid laminate WGL woodgrain laminate OAK oak	see pages 2-3

	description	sku	l	w	h	price
base 	use with RLB, RPB, RWB tops	BAK	60	31¾	28¼	\$ 2578

specification codes example: SMS-BAK

series	sku
solem	
S M S -	B A K





material + finish code example: OAK 839

base	base finish
OAK oak	

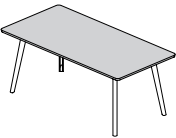

36" x 72" rectangular table

specify top and base separately
 edge detail for tops are top material specific
 solid and woodgrain laminate: flat edge with vinyl trim; specify PLL or WGL material code and edge code FS
 laminate/exposed plywood: reverse bevel with natural finish; specify PLL material code with 701 black or 702 white finish code
 oak veneer: solid oak edge with reverse bevel; specify OAK material code
 specify optional power module location when ordering top
 power style is specified separately

	description	sku	l	w	h	specifications	price
rectangular tops 	laminated specify flat edge code FS specify material code PLL or WGL 	RLC	72	36	1	use with BAL base	\$ 2097
	laminated/exposed plywood reverse bevel edge specify edge code ES for exposed edge specify material code PLL specify finish code 701 for black laminate or 702 for white laminate 	RPC	72	36	1	use with BAL base	2662
	oak reverse bevel edge specify edge code RS specify material code OAK 	RWC	72	36	1	use with BAL base	3946

specification codes example: SMS-SKU-FS000

series	sku	edge	power module location
solem		FS flat laminate ES exposed plywood RS reversed bevel	0S1 one end 0S2 both ends 000 none
S M S -	-		

material + finish code example: PLL 666

top	top finish
PLL solid laminate WGL woodgrain laminate OAK oak	see pages 2-3

	description	sku	l	w	h	price
base 	use with RLC, RPC, RWC tops	BAL	64½	31¾	28¼	\$ 2698

specification codes example: SMS-BAL

series	sku
solem	
S M S -	B A L





material + finish code example: OAK 839

base	base finish
OAK oak	

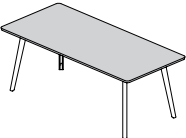

36" x 78" rectangular table

specify top and base separately
 edge detail for tops are top material specific
 solid and woodgrain laminate: flat edge with vinyl trim; specify PLL or WGL material code and edge code FS
 laminate/exposed plywood: reverse bevel with natural finish; specify PLL material code with 701 black or 702 white finish code
 oak veneer: solid oak edge with reverse bevel; specify OAK material code
 specify optional power module location when ordering top
 power style is specified separately



	description	sku	l	w	h	specifications	price
rectangular tops 	laminated specify flat edge code FS specify material code PLL or WGL 	RLD	78	36	1	use with BAM base	\$ 2378
	laminated/exposed plywood reverse bevel edge specify edge code ES for exposed edge specify material code PLL specify finish code 701 for black laminate or 702 for white laminate 	RPD	78	36	1	use with BAM base	2698
	oak reverse bevel edge specify edge code RS specify material code OAK 	RWD	78	36	1	use with BAM base	4108

specification codes example: SMS-SKU-FS000

series	sku	edge	power module location
solem		FS flat laminate ES exposed plywood RS reversed bevel	OS1 one end OS2 both ends 000 none
S M S -	-		

material + finish code example: PLL 666

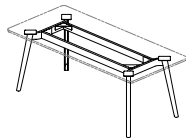
top	top finish
PLL solid laminate WGL woodgrain laminate OAK oak	see pages 2-3

	description	sku	l	w	h	price
base  	use with RLD, RPD, RWD tops	BAM	70½	31¾	28¼	\$ 2698

specification codes example: SMS-BAM

series	sku
solem	
S M S -	B A M





material + finish code example: OAK 839

base	base finish
OAK oak	

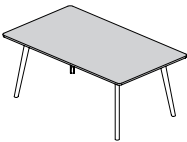

42" x 72" rectangular table

specify top and base separately
 edge detail for tops are top material specific
 solid and woodgrain laminate: flat edge with vinyl trim; specify PLL or WGL material code and edge code FS
 laminate/exposed plywood: reverse bevel with natural finish; specify PLL material code with 701 black or 702 white finish code
 oak veneer: solid oak edge with reverse bevel; specify OAK material code
 specify optional power module location when ordering top
 power style is specified separately



	description	sku	l	w	h	specifications	price
rectangular tops 	laminated specify flat edge code FS specify material code PLL or WGL 	RLE	72	42	1	use with BAN base	\$ 2741
	laminated/exposed plywood reverse bevel edge specify edge code ES for exposed edge specify material code PLL specify finish code 701 for black laminate or 702 for white laminate 	RPE	72	42	1	use with BAN base	2820
	oak 	RWE	72	42	1	use with BAN base	4186

specification codes example: SMS-SKU-FS000

series	sku	edge	power module location
solem		FS flat laminate ES exposed plywood RS reversed bevel	0S1 one end 0S2 both ends 000 none
S M S -	-		

material + finish code example: PLL 666

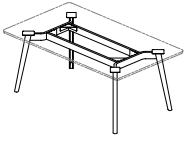
top	top finish
PLL solid laminate WGL woodgrain laminate OAK oak	see pages 2-3

	description	sku	l	w	h	price
base  	use with RLE, RPE, RWE tops	BAN	64½	36	28¼	\$ 2698

specification codes example: SMS-BAN

series	sku
solem	
S M S -	B A N

material + finish code example: OAK 839

base	base finish
OAK oak	



42" x 78" rectangular table

specify top and base separately
 edge detail for tops are top material specific
 solid and woodgrain laminate: flat edge with vinyl trim; specify PLL or WGL material code and edge code FS
 laminate/exposed plywood: reverse bevel with natural finish; specify PLL material code with 701 black or 702 white finish code
 oak veneer: solid oak edge with reverse bevel; specify OAK material code
 specify optional power module location when ordering top
 power style is specified separately

	description	sku	l	w	h	specifications	price
rectangular tops 	laminata specify flat edge code FS specify material code PLL or WGL 	RLF	78	42	1	use with BAO base	\$ 2942
	laminata/exposed plywood reverse bevel edge specify edge code ES for exposed edge specify material code PLL specify finish code 701 for black laminate or 702 for white laminate 	RPF	78	42	1	use with BAO base	3020
	oak reverse bevel edge specify edge code RS specify material code OAK 	RWF	78	42	1	use with BAO base	4431

specification codes example: SMS-SKU-FS000

series	sku	edge	power module location
solem		FS flat laminate ES exposed plywood RS reversed bevel	OS1 one end OS2 both ends 000 none
S M S -	-		

material + finish code example: PLL 666

top	top finish
PLL solid laminate WGL woodgrain laminate OAK oak	see pages 2-3

	description	sku	l	w	h	price
base 	use with RLF, RPF, RWF tops	BAO	70½	36	28¼	\$ 2741

specification codes example: SMS-BAO

series	sku
solem	
S M S -	B A O



material + finish code example: OAK 839

base	base finish
OAK oak	



42" x 84" rectangular table

specify top and base separately
 edge detail for tops are top material specific
 solid and woodgrain laminate: flat edge with vinyl trim; specify PLL or WGL material code and edge code FS
 laminate/exposed plywood: reverse bevel with natural finish; specify PLL material code with 701 black or 702 white finish code
 oak veneer: solid oak edge with reverse bevel; specify OAK material code
 specify optional power module location when ordering top
 power style is specified separately

	description	sku	l	w	h	specifications	price
rectangular tops	laminated specify flat edge code FS specify material code PLL or WGL	RLG	84	42	1	use with BAP base	\$ 3183
							
	laminated/exposed plywood reverse bevel edge specify edge code ES for exposed edge specify material code PLL specify finish code 701 for black laminate or 702 for white laminate	RPG	84	42	1	use with BAP base	3263
							
	oak reverse bevel edge specify edge code RS specify material code OAK	RWG	84	42	1	use with BAP base	4552
							

specification codes example: SMS-SKU-FS000

series	sku	edge	power module location
solem		FS flat laminate ES exposed plywood RS reversed bevel	0S1 one end 0S2 both ends 000 none
S M S -	-		

material + finish code example: PLL 666

top	top finish
PLL solid laminate WGL woodgrain laminate OAK oak	see pages 2-3

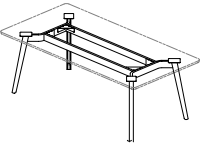
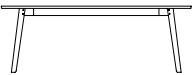
	description	sku	l	w	h	price
base	use with RLG, RPG, RWG tops	BAP	75	36	28¼	\$ 2741
						
						

specification codes example: SMS-BAP

series	sku
solem	
S M S -	B A P





material + finish code example: OAK 839

base	base finish
OAK oak	

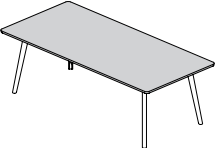

42" x 90" rectangular table

specify top and base separately
 edge detail for tops are top material specific
 solid and woodgrain laminate: flat edge with vinyl trim; specify PLL or WGL material code and edge code FS
 laminate/exposed plywood: reverse bevel with natural finish; specify PLL material code with 701 black or 702 white finish code
 oak veneer: solid oak edge with reverse bevel; specify OAK material code
 specify optional power module location when ordering top
 power style is specified separately



	description	sku	l	w	h	specifications	price
rectangular tops 	laminated specify flat edge code FS specify material code PLL or WGL 	RLH	90	42	1	use with BAQ base	\$ 3385
	laminated/exposed plywood reverse bevel edge specify edge code ES for exposed edge specify material code PLL specify finish code 701 for black laminate or 702 for white laminate 	RPH	90	42	1	use with BAQ base	3547
	oak reverse bevel edge specify edge code RS specify material code OAK 	RWH	90	42	1	use with BAQ base	4833

specification codes example: SMS-SKU-FS000

series	sku	edge	power module location
solem		FS flat laminate ES exposed plywood RS reversed bevel	OS1 one end OS2 both ends 000 none
S M S -	-		

material + finish code example: PLL 666

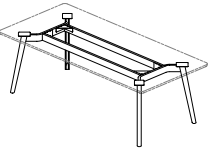
top	top finish
PLL solid laminate WGL woodgrain laminate OAK oak	see pages 2-3

	description	sku	l	w	h	price
base  	use with RLH, RPH, RWH tops	BAQ	81	36	28¼	\$ 2820

specification codes example: SMS-BAQ

series	sku
solem	
S M S -	B A Q





material + finish code example: OAK 839

base	base finish
OAK oak	

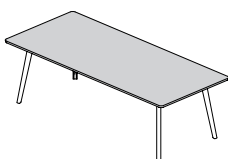

42" x 96" rectangular table

specify top and base separately
 edge detail for tops are top material specific
 solid and woodgrain laminate: flat edge with vinyl trim; specify PLL or WGL material code and edge code FS
 laminate/exposed plywood: reverse bevel with natural finish; specify PLL material code with 701 black or 702 white finish code
 oak veneer: solid oak edge with reverse bevel; specify OAK material code
 specify optional power module location when ordering top
 power style is specified separately



	description	sku	l	w	h	specifications	price
rectangular tops 	laminated specify flat edge code FS specify material code PLL or WGL 	RLI	96	42	1	use with BAR base	\$ 3624
	laminated/exposed plywood reverse bevel edge specify edge code ES for exposed edge specify material code PLL specify finish code 701 for black laminate or 702 for white laminate 	RPI	96	42	1	use with BAR base	3788
	oak reverse bevel edge specify edge code RS specify material code OAK 	RWI	96	42	1	use with BAR base	5072

specification codes example: SMS-SKU-FS000

series	sku	edge	power module location
solem		FS flat laminate ES exposed plywood RS reversed bevel	OS1 one end OS2 both ends 000 none
S M S -	-		

material + finish code example: PLL 666

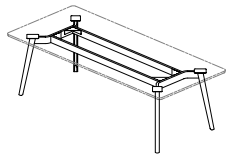
top	top finish
PLL solid laminate WGL woodgrain laminate OAK oak	see pages 2-3

	description	sku	l	w	h	price
base  	use with RLI, RPI, RWI tops	BAR	87	36	28¼	\$ 2820

specification codes example: SMS-BAR

series	sku
solem	
S M S -	B A R





material + finish code example: OAK 839

base	base finish
OAK oak	

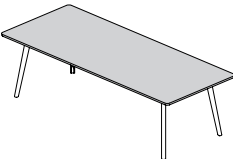

42" x 102" rectangular table

specify top and base separately
 edge detail for tops are top material specific
 solid and woodgrain laminate: flat edge with vinyl trim; specify PLL or WGL material code and edge code FS
 laminate/exposed plywood: reverse bevel with natural finish; specify PLL material code with 701 black or 702 white finish code
 oak veneer: solid oak edge with reverse bevel; specify OAK material code
 specify optional power module location when ordering top
 power style is specified separately



	description	sku	l	w	h	specifications	price
rectangular tops 	laminated specify flat edge code FS specify material code PLL or WGL 	RLJ	102	42	1	use with BAS base	\$ 3865
	laminated/exposed plywood reverse bevel edge specify edge code ES for exposed edge specify material code PLL specify finish code 701 for black laminate or 702 for white laminate 	RPJ	102	42	1	use with BAS base	4024
	oak reverse bevel edge specify edge code RS specify material code OAK 	RWJ	102	42	1	use with BAS base	5316

specification codes example: SMS-SKU-FS000

series	sku	edge	power module location
solem		FS flat laminate ES exposed plywood RS reversed bevel	OS1 one end OS2 both ends 000 none
S M S -	-		

material + finish code example: PLL 666

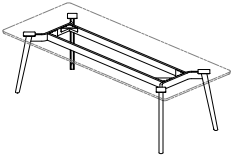
top	top finish
PLL solid laminate WGL woodgrain laminate OAK oak	see pages 2-3

	description	sku	l	w	h	price
base  	use with RLJ RPJ, RWJ tops	BAS	9 1/2	36	28 1/4	\$ 2903

specification codes example: SMS-BAS

series	sku
solem	
S M S -	B A S

material + finish code example: OAK 839

base	base finish
OAK oak	



42" x 108" rectangular table

specify top and base separately
 edge detail for tops are top material specific
 solid and woodgrain laminate: flat edge with vinyl trim; specify PLL or WGL material code and edge code FS
 laminate/exposed plywood: reverse bevel with natural finish; specify PLL material code with 701 black or 702 white finish code
 oak veneer: solid oak edge with reverse bevel; specify OAK material code
 specify optional power module location when ordering top
 power style is specified separately

	description	sku	l	w	h	specifications	price
rectangular tops 	laminated specify flat edge code FS specify material code PLL or WGL	RLK	108	42	1	use with BAT base	\$ 4147
	laminated/exposed plywood reverse bevel edge specify edge code ES for exposed edge specify material code PLL specify finish code 701 for black laminate or 702 for white laminate	RPK	108	42	1	use with BAT base	4268
	oak reverse bevel edge specify edge code RS specify material code OAK	RWK	108	42	1	use with BAT base	5556

specification codes example: SMS-SKU-FS000

series	sku	edge	power module location
solem		FS flat laminate ES exposed plywood RS reversed bevel	OS1 one end OS2 both ends 000 none
S M S -	-		

material + finish code example: PLL 666

top	top finish
PLL solid laminate WGL woodgrain laminate OAK oak	see pages 2-3

	description	sku	l	w	h	price
base 	use with RLK RPK, RWK tops	BAT	97½	36	28¼	\$ 2903

specification codes example: SMS-BAT

series	sku
solem	
S M S -	B A T





material + finish code example: OAK 839

base	base finish
OAK oak	

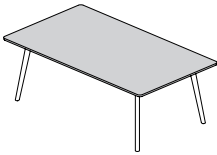

48" x 84" rectangular table

specify top and base separately
 edge detail for tops are top material specific
 solid and woodgrain laminate: flat edge with vinyl trim; specify PLL or WGL material code and edge code FS
 laminate/exposed plywood: reverse bevel with natural finish; specify PLL material code with 701 black or 702 white finish code
 oak veneer: solid oak edge with reverse bevel; specify OAK material code
 specify optional power module location when ordering top
 power style is specified separately

	description	sku	l	w	h	specifications	price
rectangular tops 	laminated specify flat edge code FS specify material code PLL or WGL 	RLL	84	48	1	use with BAU base	\$ 3366
	laminated/exposed plywood reverse bevel edge specify edge code ES for exposed edge specify material code PLL specify finish code 701 for black laminate or 702 for white laminate 	RPL	84	48	1	use with BAU base	3462
	oak reverse bevel edge specify edge code RS specify material code OAK 	RWL	84	48	1	use with BAU base	5072

specification codes example: SMS-SKU-FS000

series	sku	edge	power module location	top	top finish
solem		FS flat laminate ES exposed plywood RS reversed bevel	OS1 one end OS2 both ends 000 none	PLL solid laminate WGL woodgrain laminate OAK oak	see pages 2-3
S M S -	-				

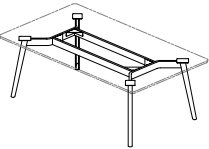
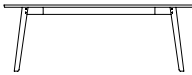
	description	sku	l	w	h	price
base  	use with RLL, RPL, RWL tops	BAU	75	42	28¼	\$ 2903





specification codes example: SMS-BAU

series	sku	material + finish code example: OAK 839
solem		base OAK oak base finish
S M S -	B A U	

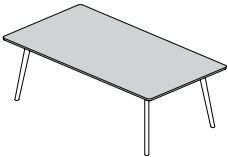

48" x 90" rectangular table

specify top and base separately
 edge detail for tops are top material specific
 solid and woodgrain laminate: flat edge with vinyl trim; specify PLL or WGL material code and edge code FS
 laminate/exposed plywood: reverse bevel with natural finish; specify PLL material code with 701 black or 702 white finish code
 oak veneer: solid oak edge with reverse bevel; specify OAK material code
 specify optional power module location when ordering top
 power style is specified separately



	description	sku	l	w	h	specifications	price
rectangular tops 	laminated specify flat edge code FS specify material code PLL or WGL 	RLM	90	48	1	use with BAV base	\$ 3547
	laminated/exposed plywood reverse bevel edge specify edge code ES for exposed edge specify material code PLL specify finish code 701 for black laminate or 702 for white laminate 	RPM	90	48	1	use with BAV base	3865
	oak reverse bevel edge specify edge code RS specify material code OAK 	RWM	90	48	1	use with BAV base	5316

specification codes example: SMS-SKU-FS000

series	sku	edge	power module location
solem		FS flat laminate ES exposed plywood RS reversed bevel	OS1 one end OS2 both ends 000 none
S M S -	-		

material + finish code example: PLL 666

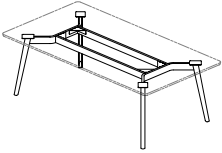
top	top finish
PLL solid laminate WGL woodgrain laminate OAK oak	see pages 2-3

	description	sku	l	w	h	price
base  	use with RLM, RPM, RWM tops	BAV	81	42	28¼	\$ 2903

specification codes example: SMS-BAV

series	sku
solem	
S M S -	B A V





material + finish code example: OAK 839

base	base finish
OAK oak	

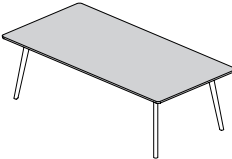

48" x 96" rectangular table

specify top and base separately
 edge detail for tops are top material specific
 solid and woodgrain laminate: flat edge with vinyl trim; specify PLL or WGL material code and edge code FS
 laminate/exposed plywood: reverse bevel with natural finish; specify PLL material code with 701 black or 702 white finish code
 oak veneer: solid oak edge with reverse bevel; specify OAK material code
 specify optional power module location when ordering top
 power style is specified separately



	description	sku	l	w	h	specifications	price
rectangular tops 	laminated specify flat edge code FS specify material code PLL or WGL 	RLN	96	48	1	use with BAW base	\$ 3788
	laminated/exposed plywood reverse bevel edge specify edge code ES for exposed edge specify material code PLL specify finish code 701 for black laminate or 702 for white laminate 	RPN	96	48	1	use with BAW base	4108
	oak reverse bevel edge specify edge code RS specify material code OAK 	RWN	96	48	1	use with BAW base	5616

specification codes example: SMS-SKU-FS000

series	sku	edge	power module location
solem		FS flat laminate ES exposed plywood RS reversed bevel	OS1 one end OS2 both ends 000 none
S M S -	-		

material + finish code example: PLL 666

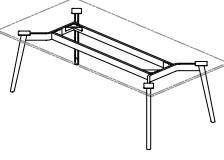
top	top finish
PLL solid laminate WGL woodgrain laminate OAK oak	see pages 2-3

	description	sku	l	w	h	price
base  	use with RLN, RPN, RWN tops	BAW	87	42	28¼	\$ 2903

specification codes example: SMS-BAW

series	sku
solem	
S M S -	B A W

material + finish code example: OAK 839

base	base finish
OAK oak	



48" x 102" rectangular table

specify top and base separately
 edge detail for tops are top material specific
 solid and woodgrain laminate: flat edge with vinyl trim; specify PLL or WGL material code and edge code FS
 laminate/exposed plywood: reverse bevel with natural finish; specify PLL material code with 701 black or 702 white finish code
 oak veneer: solid oak edge with reverse bevel; specify OAK material code
 specify optional power module location when ordering top
 power style is specified separately

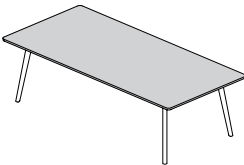

	description	sku	l	w	h	specifications	price
rectangular tops 	laminated specify flat edge code FS specify material code PLL or WGL	RLO	102	48	1	use with BAX base	\$ 4024
	laminated/exposed plywood reverse bevel edge specify edge code ES for exposed edge specify material code PLL specify finish code 701 for black laminate or 702 for white laminate	RPO	102	48	1	use with BAX base	4108
	oak reverse bevel edge specify edge code RS specify material code OAK	RWO	102	48	1	use with BAX base	5616

specification codes example: SMS-SKU-FS000

series	sku	edge	power module location
solem		FS flat laminate ES exposed plywood RS reversed bevel	OS1 one end OS2 both ends 000 none
S M S -	-		

material + finish code example: PLL 666

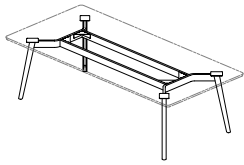
top	top finish
PLL solid laminate WGL woodgrain laminate OAK oak	see pages 2-3

	description	sku	l	w	h	price
base  	use with RLO, RPO, RWO tops	BAX	9 1/2	42	28 1/4	\$ 2982

specification codes example: SMS-BAX

series	sku
solem	
S M S -	B A X





material + finish code example: OAK 839

base	base finish
OAK oak	

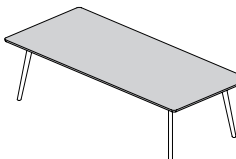

48" x 108" rectangular table

specify top and base separately
 edge detail for tops are top material specific
 solid and woodgrain laminate: flat edge with vinyl trim; specify PLL or WGL material code and edge code FS
 laminate/exposed plywood: reverse bevel with natural finish; specify PLL material code with 701 black or 702 white finish code
 oak veneer: solid oak edge with reverse bevel; specify OAK material code
 specify optional power module location when ordering top
 power style is specified separately



	description	sku	l	w	h	specifications	price
rectangular tops 	laminated specify flat edge code FS specify material code PLL or WGL 	RLP	108	48	1	use with BAY base	\$ 4268
	laminated/exposed plywood reverse bevel edge specify edge code ES for exposed edge specify material code PLL specify finish code 701 for black laminate or 702 for white laminate 	RPP	108	48	1	use with BAY base	4346
	oak reverse bevel edge specify edge code RS specify material code OAK 	RWP	108	48	1	use with BAY base	6087

specification codes example: SMS-SKU-FS000

series	sku	edge	power module location
solem		FS flat laminate ES exposed plywood RS reversed bevel	OS1 one end OS2 both ends 000 none
S M S -	-		

material + finish code example: PLL 666

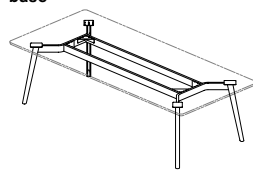
top	top finish
PLL solid laminate WGL woodgrain laminate OAK oak	see pages 2-3

	description	sku	l	w	h	price
base  	use with RLP, RPP, RWP tops	BAY	97½	42	28¼	\$ 2982

specification codes example: SMS-BAY

series	sku
solem	
S M S -	B A Y

material + finish code example: OAK 839

base	base finish
OAK oak	

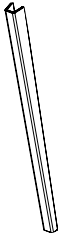
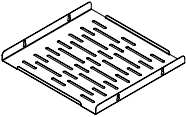
description	sku	w	d	h	weight	specifications	price
wire manager							
	dark gray pressed felt specify pressed felt wire manager for each power module	MWM	1 3/8	1 1/4	22 7/8		\$ 159
wire management tray							
	formed metal holds equipment or excess wiring	VMT	12	12 3/4	1		289

series

accessories

sku

S | M | S | -

power module finish

BK black

BN nickel

Prices and Specifications

Prices and specifications are subject to change without notice. All prices quoted will be FOB our factories. If applicable, sales tax will be based on ship-to destination.

Bernhardt Design reserves the right to make changes in dimensions, construction, price lists, or product literature without prior notice.

All measurements and weights are approximate and subject to change without notice.

Order Entry

All orders are subject to final acceptance by Bernhardt Design in Lenoir, NC. Receipt of our acknowledgment indicates acceptance of your order subject to the terms set forth on the acknowledgment.

Bernhardt Design attempts to clarify all purchase orders. However, in the event the price list number and description on the purchase order differ, the price list number will prevail.

Changes/Cancellation

All orders in production are considered firm orders and are not subject to changes or cancellation.

Shipping

Bernhardt Design will ship in accordance with customer instructions whenever possible. For convenience, Bernhardt Design offers a guaranteed freight program (GFP). Bernhardt Design will exercise our best judgment in selecting a carrier under our GFP. When selecting a carrier, Bernhardt Design will make our best effort to meet requested delivery dates.

Transportation lead-times and delays including equipment problems, weather, general traffic, traffic accidents, customer warehouse space, labor disputes, customer changes, etc., that occur on a carrier will not be the responsibility of Bernhardt Design. Furthermore, Bernhardt Design will not be responsible for additional costs incurred due to aforementioned delays.

For customers who decline our GFP, Bernhardt Design will stage orders for pick up at 1% of the list price, or \$75 minimum.

Customer orders in production will be shipped as scheduled and will not be held. Bernhardt Design reserves the right to make partial shipments on any order, unless notified otherwise by the customer.

High quality cartoning meeting trucking and railroad specifications is standard at no extra charge. Some items may be blanket wrapped for shipment.

Freight Damage and Claims

Bernhardt Design is not liable for any damages to products that occur during transit or storage. The carrier assumes all responsibility upon acceptance of product. It is the customer's responsibility to inspect products upon receipt and file any claims with the carrier. No product should be refused. If products are received damaged, a written exception should be made on the bill of lading and an immediate inspection be requested of the carrier.

Concealed damage must be reported to the carrier within 10 business days from date of delivery. Failure to make claims shall constitute acceptance of the products and waiver any claims of defects, errors or shortages.

In the event delivery is made on a Bernhardt Design truck, the products should be carefully inspected for transit damage. If contents are damaged, the driver should be notified to call his dispatcher for immediate disposition.

Concealed damage must be reported within 10 business days from date of delivery and product/packaging held for inspection by a Bernhardt Design representative. Replacements for product damaged in shipment or storage will be manufactured upon receipt of a purchase order.

Returns

No merchandise may be returned to Bernhardt Design without written consent in the form of a Return Authorization from our Quality Assurance Department stating why item is being returned and how item will be shipped.

Unauthorized returns will be automatically refused by our receiving department as well as returns not in accordance with Bernhardt Design shipping instructions. Liability for defective merchandise shall be limited to the replacement or repair of that merchandise, and Bernhardt Design shall not be liable for other damages or losses.

Terms and Credit

Pricing and terms of sale apply to orders accepted by Bernhardt Design, and no terms, stipulations, or conditions contained in the dealer's submitted purchase orders shall have any force or effect. Bernhardt Design requires a completed and signed credit application from every dealer. Bernhardt Design also requires dealers to provide a Blanket Certificate of Resale/Use containing valid sales tax exemption number(s) for their respective state(s).

If credit has been approved, the standard terms for all Bernhardt Design products are Net 30 from the invoice date. In certain instances, as an additional condition of order acceptance, buyer may be required to provide a deposit at time of order and/or remit the balance before shipment is released. If credit has not been approved, a 100% prepayment, including any freight charges, is required prior to production.

Acceptable forms of payment include a certified check or electronic bank transfer. For information on where to send check/electronic bank information contact our Financial Services Department. If a dealer or company check is submitted, three (3) weeks should be allowed for the clearance of the check. If electronic bank transfer is submitted, one (1) week should be allowed for the clearance of the electronic bank transfer. The order is subject to cancellation if payment in full is not received within three (3) weeks from the acknowledgment date.

The dealer may not make deductions for advertising, promotions, quality problems, freight, or any other reason without prior authorization by Bernhardt Design. Such a deduction could result in the curtailment or suspension of further shipments until the matter is resolved. Delinquency notices are generated and mailed periodically. Service charges of 18% per annum will be added to each past-due transaction. Unpaid service charges

will be accrued and invoiced on a periodic basis. Past-due notices may result in orders being held until the situation is resolved. This credit hold could prevent orders from being placed into production or shipped. Orders not in production that are placed on credit hold for three (3) weeks will be subject to cancellation.

Severe past-due situations may result in the employment of a collection agency or other collection litigation. If any collection activity is necessary regarding a dealer account, the dealer will be responsible for the payment of any and all attorney and collection agency fees.

A slow payment history may result in reducing or eliminating an open line of credit. At the discretion of Bernhardt Design, amounts owed by a dealer to Bernhardt Design arising from any transaction or dealings between the dealer and Bernhardt Design may be offset against any amounts owed to the dealer by Bernhardt Design.

Warranty

Bernhardt Design will repair or replace, at its discretion, any product or part thereof which fails as the result of defects in material and workmanship, under single shift use and normal care for five years from date of shipment. This warranty shall apply only to the original purchaser.

This warranty does not cover normal wear and tear, misuse or abuse of product, dramatic temperature changes, exposure to unusual conditions or damages incurred by contact with seating products, tables, desks or other surfaces. Natural color changes, variations or movements in lumber or veneer products, exposure to extreme temperature changes and direct sunlight may cause color changes and/or surface damage. These are circumstances beyond the control of Bernhardt Design and are not warranty issues. Repair or replacement of discontinued product will be at the discretion of Bernhardt Design.

This warranty is the customer's exclusive remedy for product defect and does not apply to damage caused by a freight carrier, dealer, installer, user modification, attachments to a product, or any third party. Bernhardt Design has the exclusive right to make the final determination of product misuse or abuse. Except as stated above, Bernhardt Design makes no express or implied warranties as to any product, and in particular, makes no warranty of merchantability or of fitness for any particular purpose. Bernhardt Design shall not be liable for any consequential or incidental damages or for commercial loss arising from any product defect.

Operational Parts Warranty

Drawer glides, drawer boxes, drawer pulls, and lock mechanisms have a Life-Time Warranty for original purchaser. Power and communication components are warranted for one year.

Parts Order

Bernhardt Design parts have a \$25 net minimum per order. This does not include freight costs.

Custom Design

Bernhardt Design may alter products to meet specific needs. Contact your local sales representative when a custom design is needed. Custom designs,

if approved, require minimum quantities, additional leadtime and upcharges. A custom job number, available from your Bernhardt Design sales representative, must be submitted with purchase orders.

Orders combining custom design with standard product cannot be scheduled for production until custom items are approved. Custom design orders are not subject to revision or cancellation after acknowledgment.

Wood Finishes

Bernhardt Design tables are available in finishes that are compatible with credenzas and seating finishes. However, finishes on tables may vary slightly from those on seating due to the natural characteristics of the wood. No absolute match is implied or guaranteed.

Light Finishes

Bernhardt Design offers lighter finishes on certain veneers and solid woods. When specifying light finishes the natural characteristics of the wood will be visible and color will vary.

Natural characteristics include the natural discolorations of the wood substance and color variations in glued up stock. These natural characteristics are not considered defects by Bernhardt Design, and therefore merchandise will not be replaced.

Special Finishes

Special finishes, made to customer specifications and subject to factory approval, may be available at a **10% net upcharge with a \$500 net minimum**.

Additional leadtime may be required for special finish items. Special finish orders will not be acknowledged until the special finish sample is approved in writing and received by Bernhardt Design Customer Service. Special finish orders are not subject to revision or cancellation after acknowledgment.

Installation and Maintenance

All freestanding tables and credenzas are equipped with leveling devices. Local floor conditions vary, and it is always necessary to properly adjust leveling devices. Proper leveling is essential to the alignment and function of doors and drawers.

Improperly leveled units result in misaligned doors and drawers and may impair locking mechanisms or other functional hardware.

After the initial installation of credenzas, it may be necessary to readjust and align the units to compensate for settling. This should be expected as a matter of routine maintenance and follow-up to assure proper case function.

Proper installation of Bernhardt Design tables and credenzas is the responsibility of the dealer. Improperly installed units can result in permanent damage to case components. Damage due to improperly installed furniture not covered under product warranty.

Orders combining custom design with standard product cannot be scheduled for production until custom items are approved. Custom design orders are not subject to revision or cancellation after acknowledgment.

Care and Cleaning

Finished wood surfaces should be cleaned with a soft damp cloth, wiping in the direction of the grain. Furniture should be buffed dry immediately with a soft cloth.

Design and Patent Rights

All of the products shown in Bernhardt Design catalogs and described in Bernhardt Design price lists are, and remain, the property of Bernhardt Design, with the sole right reserved to manufacture and to distribute.

Some of the product designs shown are patented in the United States and will remain the property of Bernhardt Design. Any reproduction of the products constitutes an infringement of patented copyright laws and will be subject to prosecution.

Environmental

Some tables and credenzas are LEVEL[®] for ANSI/BIFMA e3-2019 – Furniture Sustainability Standard and SCS Indoor Advantage[™] Gold certified. Visit the product page at bernhardtdesign.com for certifications.

Preferred Carrier Guaranteed Freight Rates

Freight charges will be applied to orders as a separate line item based on the zones listed. Rates are based on zones with a minimum for each zone. All zones are located within the Continental United States.

The freight amount is calculated on the total merchandise list COM price. Additional freight fuel surcharges may apply. Rates are based on deliveries made Monday through Friday, 8 am until 5 pm.

All orders are shipped by Bernhardt Design company trucks or preferred carriers specified by Bernhardt Design. **If a purchase order does not specify that the product must ship complete, Bernhardt Design reserves the right to select the most effective shipping method necessary, including split shipments.** Dealer warehouse information, including phone number and contact name, must be specified on the purchase order.

Zone	Percent	Minimum
Zone 1	3%	\$150
Zone 2	4%	\$150
Zone 3	5%	\$150
Zone 4	5.5%	\$150
Zone 5	6%	\$150

Percent bases on List Price.

Direct site deliveries may be requested with an additional freight cost. Requests for direct site deliveries must be made 2 weeks prior to the scheduled ship week and meet the following criteria:

- Minimum of half truckload
- Delivery site accessible by a 53' trailer
- Complete delivery site address with contact name and on-site phone number
- Labor available for unloading

Deliveries that do not meet the criteria must be directed to a receiver warehouse. If a receiver warehouse is not available, the dealer may make arrangements with their own 3rd party carrier. If a 3rd party carrier is elected, a contact name, phone number and e-mail address is required.

Bernhardt Design has a no touch freight policy. Drivers are not allowed to unload freight.

Weekend direct site deliveries will incur a \$500 per trailer weekend delivery fee. Weekend is defined as between 5 pm Friday and 8 am Monday.

Customers who decline GFP should refer to the shipping section of the Terms and Conditions page.

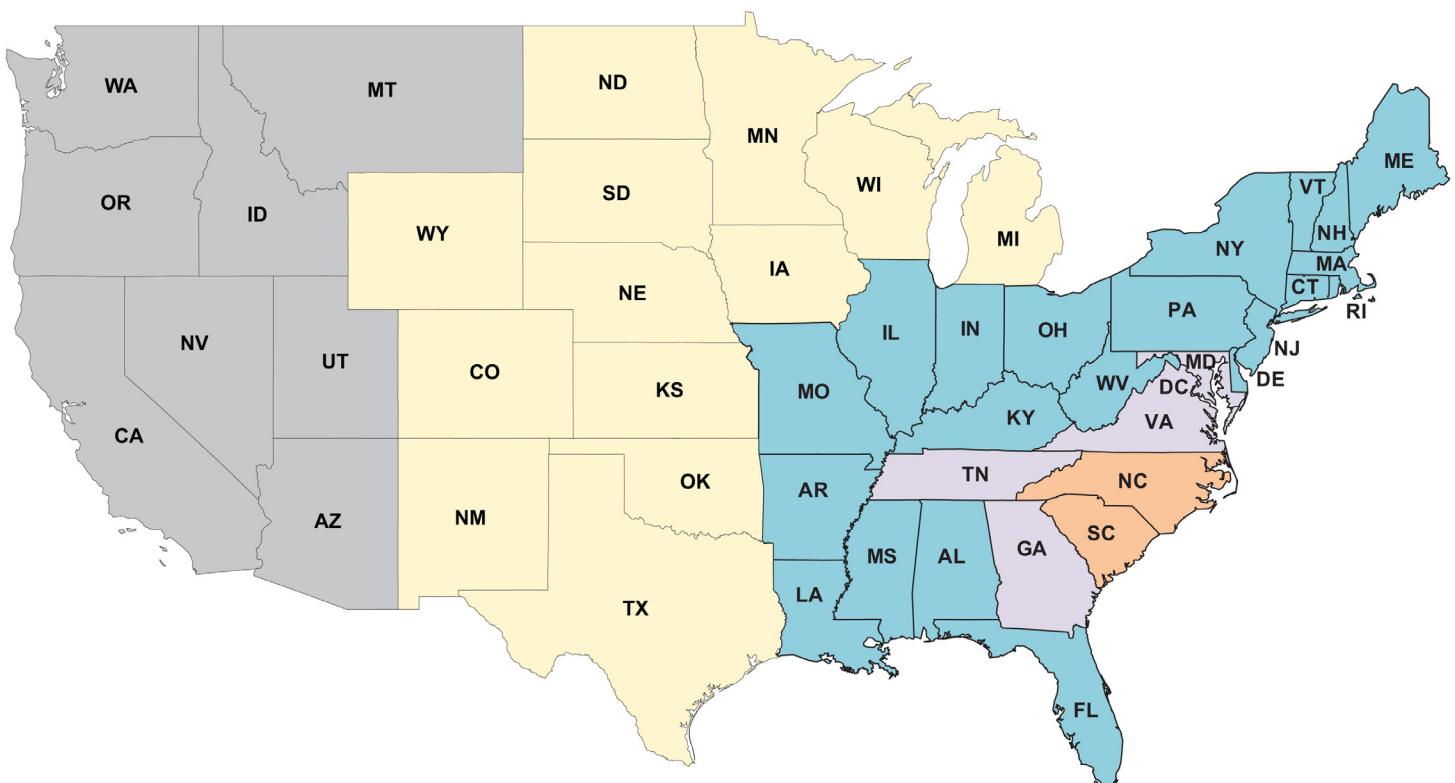

Preferred Carrier Guaranteed Freight Rates - Canada

Freight charges will be applied to orders as a separate line item based on the zones listed. Rates are based on zones with a minimum for each zone.

The freight amount is calculated on the total merchandise list COM price. Additional freight fuel surcharges may apply. Rates are based on deliveries made Monday through Friday, 8 am until 5 pm.

All orders are shipped by Bernhardt Design company trucks or preferred carriers specified by Bernhardt Design. If a purchase order does not specify that the product must ship complete, Bernhardt Design reserves the right to select the most effective shipping method necessary, including split shipments. Dealer warehouse information, including phone number and contact name, must be specified on the purchase order.

Direct site deliveries may be requested with an additional freight cost. Requests for direct site deliveries must be made 2 weeks prior to the scheduled ship week and meet the following criteria:

- Minimum of half truckload
- Delivery site accessible by a 53' trailer
- Complete delivery site address with contact name and on-site phone number
- Labor available for unloading

Deliveries that do not meet the criteria must be directed to a receiver warehouse. If a receiver warehouse is not available, the dealer may make arrangements with their own 3rd party carrier. If a 3rd party carrier is elected, a contact name, phone number and e-mail address is required.

Bernhardt Design has a no touch freight policy. Drivers are not allowed to unload freight.

Weekend direct site deliveries will incur a \$500 per trailer weekend delivery fee. Weekend is defined as between 5 pm Friday and 8 am Monday.

Customers who decline GFP should refer to the shipping section of the Terms and Conditions page.

Zone	Minimums	Freight	Avg. Bus. Days
Zone 1	\$200	5%	10-15
Zone 2	\$200	9%	10-15
Zone 3	\$200	8%	10-15
Zone 4	\$200	11%	10-15
Zone 5	Quote	Quote	

The attached rates are strictly freight and do not include brokerage fees.

