

SPECIFICATIONS

Insight Hub (INS1000-W):

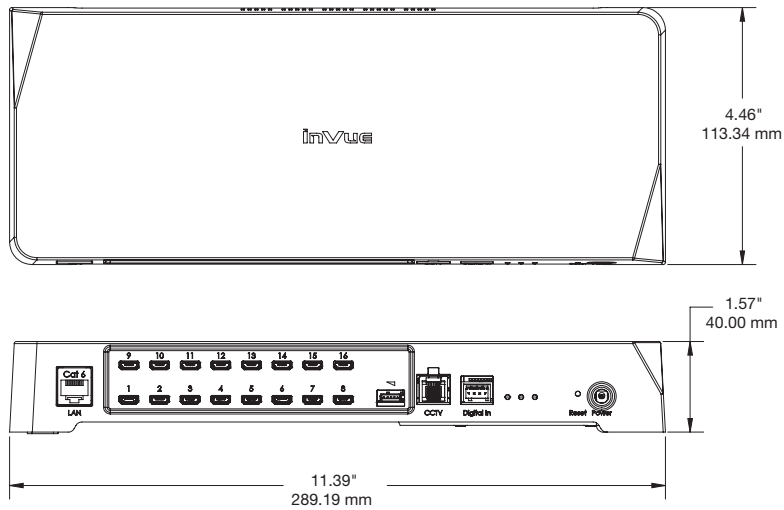

Insight Expansion Box (INS2000-W):

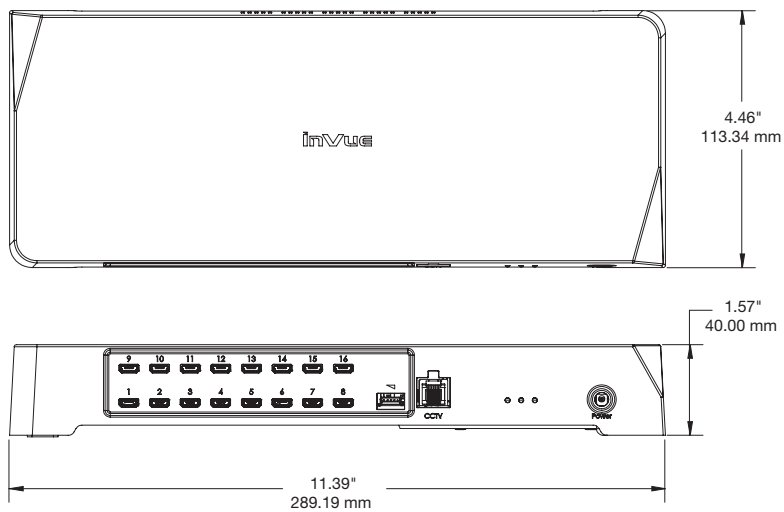

SPECIFICATIONS

5M Insight Expansion Box/Hub Data Cable (INS3100-W):

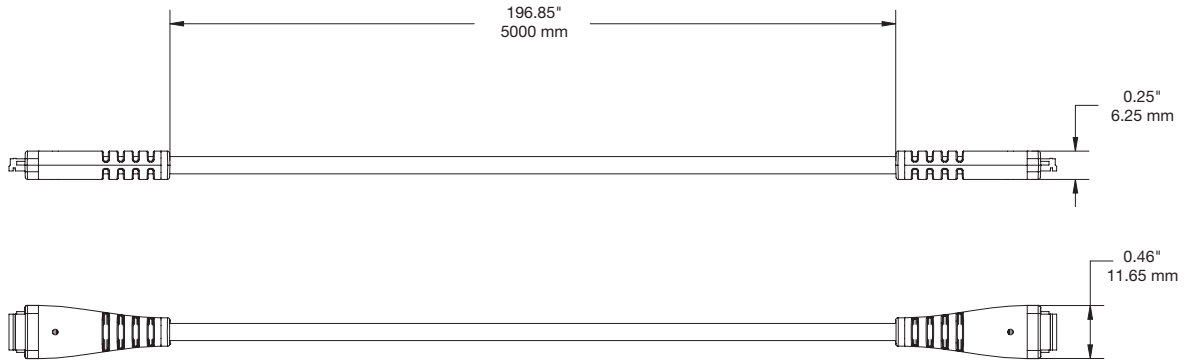

One65 Insight Hub Cable 2.5M (INS3320):

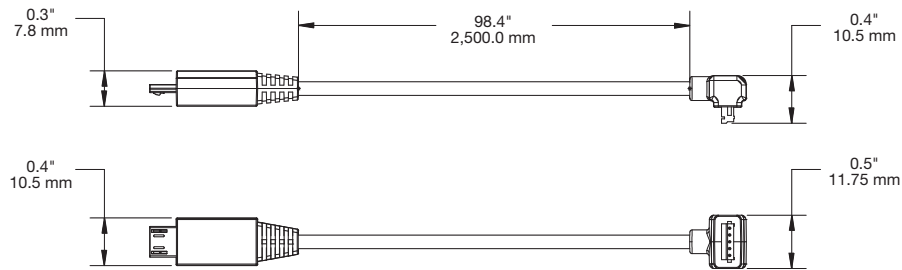

SPECIFICATIONS

One65 Insight Hub Cable 5.0M (INS3220):

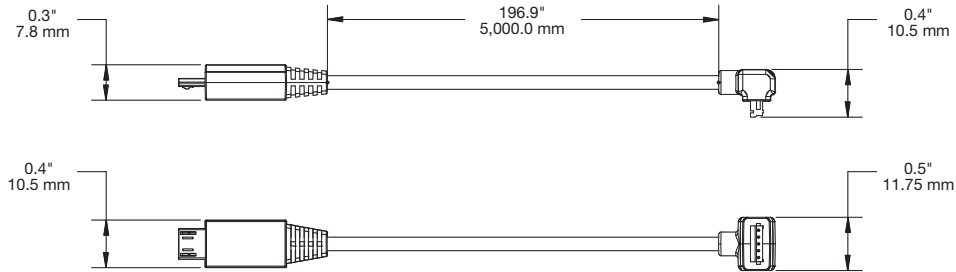

S1060/S1560 5M Insight Hub/POD Data Cable (INS3210-W):

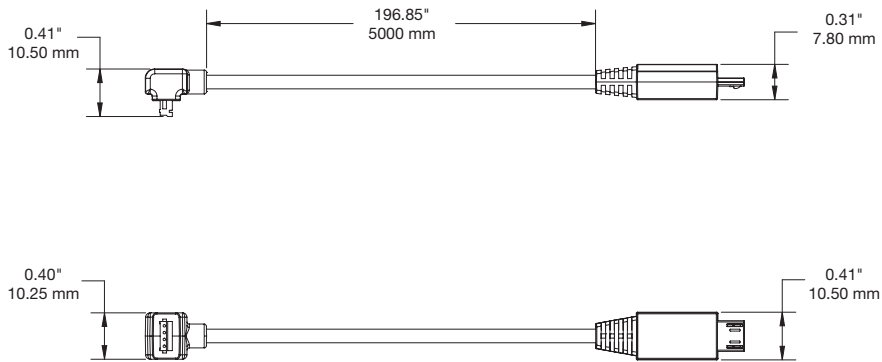

SPECIFICATIONS

S1060/S1560 2.5M Insight Hub/POD Data Cable (INS3310-W):

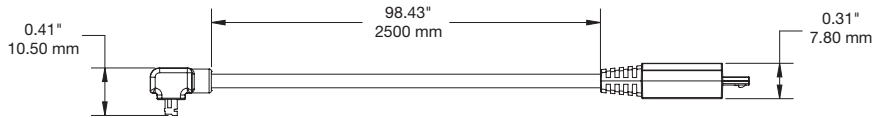

See the OnePOD and S1060/S1560 sell sheets for more details regarding PODs that support Insight.



PRODUCT ORDERING

ORDER CODE	DESCRIPTION	NOTES	INVENTORY STATUS
INSIGHT ORDER CODES			
<i>Software Subscription</i>			
INS6100	Insight Annual Pricing 1-99 Devices		
INS6200	Insight Annual Pricing 100-249 Devices		
INS6300	Insight Annual Pricing 250-499 Devices		
INS6400	Insight Annual Pricing 500-2,499 Devices		
INS6500	Insight Annual Pricing 2,500-4,999 Devices		
INS6600	Insight Annual Pricing 5,000-9,999 Devices		
INS6700	Insight Annual Pricing 10,000-24,999 Devices		
INS6800	Insight Annual Pricing 25,000-49,999 Devices		
INS6900	Insight Annual Pricing 50,000+ Devices		
<i>Training and Setup Services</i>			
INS5000	Insight Partner Training		
INS8000	Insight Initial Setup Services		
<i>Hubs and Expansion Boxes</i>			
INS1000-W	Insight Hub - White		
INS2000-W	Insight Expansion Box - White		
INS4000-B	USB-A to Insight Power Connector - Black	› Required to connect each INS1000 or INS2000 to a power supply	
INS3100-W	5M Insight Expansion/Hub Data Cable - White	› For connecting an Insight expansion box to a hub	
PS515	5V USB-A Positive Slope Power Supply	› For Insight hubs and expansion boxes	



PRODUCT ORDERING

ORDER CODE	DESCRIPTION	NOTES	INVENTORY STATUS
One65 PODs			
Insight Stands			
DBD120-W DBD120-B	One65 Angled Standard Security Stand - White One65 Angled Standard Security Stand - Black		Core Market Planning
DBD126-W DBD126-B	One65 Flat Standard Security Stand - White One65 Flat Standard Security Stand - Black		Market Planning Market Planning
DBD121-W DBD121-B	One65 Angled Enhanced Security Stand - White One65 Angled Enhanced Security Stand - Black		Market Planning Market Planning
DBD127-W DBD127-B	One65 Flat Enhanced Security Stand - White One65 Flat Enhanced Security Stand - Black		Market Planning Market Planning
PS531	5V, 3A Power Supply		Core
PS535	USB PD Power Supply		Core
Insight Sensors			
DBD201-W DBD201-B	One65 Alarming Insight Sensor - White One65 Alarming Insight Sensor - Black		Core Market Planning
Insight Power Connectors			
DBH507-W DBH507-B	One65/One60 HH USB Micro Insight Pwr Connector - White One65/One60 HH USB Micro Insight Pwr Connector - Black	> 4 pack	Core Market Planning
DBT507-W DBT507-B	One65/One60 Tablet USB Micro Insight Pwr Connector - White One65/One60 Tablet USB Micro Insight Pwr Connector - Black	> 4 pack	Core Market Planning
DBH508-W DBH508-B	One65/One60 HH USB Type C Insight Pwr Connector - White One65/One60 HH USB Type C Insight Pwr Connector - Black	> 4 pack	Core Market Planning
DBT508-W DBT508-B	One65/One60 Tablet USB Type C Insight Pwr Connector - White One65/One60 Tablet USB Type C Insight Pwr Connector - Black	> 4 pack	Core Market Planning
DBH509-W DBH509-B	One65/One60 HH Lightning Insight Pwr Connector - White One65/One60 HH Lightning Insight Pwr Connector - Black	> 4 pack	Core Market Planning
DBT509-W DBT509-B	One65/One60 Tablet Lightning Insight Pwr Connector - White One65/One60 Tablet Lightning Insight Pwr Connector - Black	> 4 pack	Core Market Planning
Insight Cables			
INS3320-W INS3320-B	One65/One60 Insight Hub Cable 2.5M - White One65/One60 Insight Hub Cable 2.5M - Black	> 4 pack	Core Market Planning
INS3220-W INS3220-B	One65/One60 Insight Hub Cable 5.0M - White One65/One60 Insight Hub Cable 5.0M - Black	> 4 pack	Core Market Planning

*Market Planning designates that parts will be available with validated opportunity and standard lead-time

*See the OnePOD and S1060/S1560 sell sheets for a list of all order codes associated with these PODs



PRODUCT ORDERING

ORDER CODE	DESCRIPTION	NOTES	INVENTORY STATUS
One60 PODs			
<i>Insight Stands</i>			
DBD162-W	One60 Premium Angled Stand - White		Market Planning
DBD162-B	One60 Premium Angled Stand - Black		Market Planning
DBD168-W	One60 Premium Flat Stand - White		Market Planning
DBD168-B	One60 Premium Flat Stand- Black		Market Planning
PS531	5V, 3A Power Supply		Core
PS535	USB PD Power Supply		Core
<i>Insight Sensors</i>			
DBD211-W	One60 Alarming Insight Sensor - White		Core
DBD211-B	One60 Alarming Insight Sensor - Black		Market Planning
<i>Insight Stand/Sensor Kits</i>			
DBD862-W	One60 Premium Angled Stand with Sensor - White		Market Planning
DBD862-B	One60 Premium Angled Stand with Sensor - Black		Market Planning
DBD868-W	One60 Premium Flat Stand with Sensor - White		Market Planning
DBD868-B	One60 Premium Flat Stand with Sensor - Black		Market Planning
<i>Insight Power Connectors</i>			
DBH507-W	One65/One60 HH USB Micro Insight Pwr Connector - White	› 4 pack	Core
DBH507-B	One65/One60 HH USB Micro Insight Pwr Connector - Black		Market Planning
DBT507-W	One65/One60 Tablet USB Micro Insight Pwr Connector - White	› 4 pack	Core
DBT507-B	One65/One60 Tablet USB Micro Insight Pwr Connector - Black		Market Planning
DBH508-W	One65/One60 HH USB Type C Insight Pwr Connector - White	› 4 pack	Core
DBH508-B	One65/One60 HH USB Type C Insight Pwr Connector - Black		Market Planning
DBT508-W	One65/One60 Tablet USB Type C Insight Pwr Connector - White	› 4 pack	Core
DBT508-B	One65/One60 Tablet USB Type C Insight Pwr Connector - Black		Market Planning
DBH509-W	One65/One60 HH Lightning Insight Pwr Connector - White	› 4 pack	Core
DBH509-B	One65/One60 HH Lightning Insight Pwr Connector - Black		Market Planning
DBT509-W	One65/One60 Tablet Lightning Insight Pwr Connector - White	› 4 pack	Core
DBT509-B	One65/One60 Tablet Lightning Insight Pwr Connector - Black		Market Planning
<i>Insight Cables</i>			
INS3320-W	One65/One60 Insight Hub Cable 2.5M - White	› 4 pack	Core
INS3320-B	One65/One60 Insight Hub Cable 2.5M - Black		Market Planning
INS3220-W	One65/One60 Insight Hub Cable 5.0M - White	› 4 pack	Core
INS3220-B	One65/One60 Insight Hub Cable 5.0M - Black		Market Planning

*Market Planning designates that parts will be available with validated opportunity and standard lead-time

*See the OnePOD and S1060/S1560 sell sheets for a list of all order codes associated with these PODs.



PRODUCT ORDERING

ORDER CODE	DESCRIPTION	NOTES	INVENTORY STATUS
S1060/S1560 PODs			
Insight Stands			
DRD105-W	Series 1060 Flat Stand - White		
DRD106-W	Series 1060 Angled Stand - White		
DSD100-W	Series 1560 Angled Alarming Stand - White		
DSD101-W	Series 1560 Zero Degree Alarming Stand - White		
DSD300-W	Series 1560 Recoiler - White		
PS531	5V 3A Power Supply	› For S1060/S1560 stands	
Insight Sensors			
DRH210-W	S1060/S1560 HH Micro USB Android Insight Sensor - White		
DRH211-W	S1060/S1560 HH Apple Lightning Insight Sensor - White		
DRH213-W	S1060/S1560 HH USB Type C Android Insight Sensor - Wht		
DRT210-W	S1060/S1560 TAB Micro-USB Android Insight Sensor - Wht		
DRT211-W	S1060/S1560 TAB Apple Lightning Insight Sensor - White		
DRT213-W	S1060/S1560 TAB USB Type C Android Insight Sensor - Wht		
Insight Cables			
INS3210-W	5M Insight Hub/POD Data Cable - White	› 4 pack	
INS3310-W	2.5M Insight Hub/POD Data Cable - White	› 4 pack	

*See the OnePOD and S1060/S1560 sell sheets for a list of all order codes associated with these PODs.

invue.com

©2018 InVue Security Products. No endorsement of InVue products has been made by any of the manufacturers of the products shown. Product is sold pursuant to InVue's warranty which can be found at www.invue.com/warranty.

THE AMERICAS 704.752.6513 • 888.55.INVUE
EUROPE, MIDDLE EAST & AFRICA +31.23.8900150
ASIA PACIFIC +852.3127.6811

