



Fitness Systems

by Endless Pools®

OWNER'S MANUAL

WELCOME



Watkins Wellness congratulates you on your decision to enjoy the finest fitness system available. Welcome to the growing family of fitness systems by ENDLESS POOLS owners.

OWNER'S MANUAL

This Owner's Manual will acquaint you with the operation and general maintenance of your new fitness system. We suggest that you take some time to carefully review all sections. Please keep this manual available for reference.

If you have questions about any aspect of your fitness system's set-up, operation or maintenance, contact your authorized **ENDLESS POOLS** dealership. They are trained professionals who are familiar with the product, as well as new fitness system ownership concerns. Their expertise will facilitate the enjoyment of your new fitness system.

The serial number/identification label is located within the equipment compartment of your fitness system. The serial number should also be documented on the delivery receipt from your dealer.

IMPORTANT: Watkins Wellness reserves the right to change specifications, or design, without notification and without incurring any obligation.

DATE PURCHASED: _____

DATE INSTALLED: _____

DEALER: _____

ADDRESS: _____

TELEPHONE: _____

MODEL/SERIAL NUMBER: _____

COVER SERIAL NUMBER: _____

In most cities and counties, permits will be required for the installation of electrical circuits or the construction of exterior surfaces (decks and gazebos). In addition, some communities have adopted residential barrier codes which may require fencing and/or self-closing gates on the property to prevent unsupervised access to the fitness system by children. As a general practice, your local Building Department will inform you of any applicable barrier requirements at the time a permit is obtained for the installation of an electrical circuit. Your **ENDLESS POOLS** dealer can provide information on which permits may be required.

TABLE OF CONTENTS

SAFETY INFORMATION

IMPORTANT SAFETY INSTRUCTIONS.....	1
IMPORTANT FITNESS SYSTEM INSTRUCTIONS.....	3

SITE REQUIREMENTS

INDOOR CONSIDERATIONS	4
OUTDOOR CONSIDERATIONS.....	4

ELECTRICAL REQUIREMENTS

230 VOLT CONNECTED (STANDARD).....	5
EQUIPMENT COMPARTMENT	6
DOOR PANEL REMOVE & REPLACE.....	6

GETTING STARTED

E500 & E700 FITNESS SYSTEM FEATURES	7
ADDITIONAL FITNESS SYSTEM FEATURES.....	7
E550 FITNESS SYSTEM FEATURES.....	8
ADDITIONAL FITNESS SYSTEM FEATURES.....	8
HYDROMASSAGE JETS.....	9
WATERFALL VALVE (E500 & E700).....	9
AIR CONTROLS	9
SWIM MACHINE-HYDRAULIC	9
TREADMILL-HYDRAULIC (OPTIONAL).....	9
PACE DISPLAY (OPTIONAL).....	10
QUICK START-UP INSTRUCTIONS	10

OPERATING INSTRUCTIONS

MAIN CONTROL PANEL	12
SETTINGS.....	12
AUDIO IN.STREAM 2 (OPTIONAL).....	14
TEMPERATURE CONTROL	14
JETS CONTROL.....	15
LIGHT CONTROL.....	15

PURGE TIME	15
WI-FI IN.TOUCH™ 2 (OPTIONAL)	15
SMART WINTER MODE	15
AUXILIARY CONTROL PANEL	15

WATER QUALITY AND MAINTENANCE

BASIC INFORMATION.....	16
CHEMICAL SAFETY	16
HOW TO ADD CHEMICALS TO THE WATER	16
FUNDAMENTALS OF WATER MAINTENANCE.....	16
THE ENDLESS POOLS WATER MAINTENANCE PROGRAM.....	17
VACATION WATER CARE INSTRUCTIONS.....	18
GLOSSARY.....	19

CARE AND MAINTENANCE

FILTER MAINTENANCE	20
FILTER CARTRIDGE REMOVAL AND CLEANING INSTRUCTIONS	20
DRAINING YOUR FITNESS SYSTEM.....	21
WINTERIZING YOUR FITNESS SYSTEM	21
CARE OF THE EXTERIOR.....	22

SERVICE INFORMATION

GENERAL INFORMATION	23
GFCI AND HIGH LIMIT THERMOSTAT	23
MISCELLANEOUS SERVICE INFORMATION.....	23
ACTS INVALIDATING WARRANTY.....	23
DISCLAIMERS.....	23
WATKINS WELLNESS CUSTOMER SERVICE.....	24
TROUBLESHOOTING	24

SAFETY INFORMATION

IMPORTANT SAFETY INSTRUCTIONS

(READ AND FOLLOW ALL INSTRUCTIONS)

AVOIDING THE RISK TO CHILDREN

DANGER - RISK OF CHILD DROWNING

Extreme caution must be exercised to prevent unauthorized access by children. To avoid accidents, ensure that children cannot use a fitness system unless they are supervised at all times.

WARNING

To reduce the risk of injury, do not permit children to use this fitness system unless they are closely supervised at all times.

- To reduce the risk of injury, lower water temperatures are recommended for young children. Children are especially sensitive to hot water.
- Extreme caution must be exercised to prevent unauthorized access by children. To avoid accidents, ensure that children cannot use the fitness system unless they are supervised at all times.

DO:

- Make sure you always lock any child resistant locks after using the fitness system for your children's safety.
- Test the water temperature with your hand before allowing children to enter the fitness system to be sure that it's comfortable.
- Remind children that wet surfaces can be very slippery. Make sure that children are careful when entering or exiting the fitness system.

DON'T:

- Allow children to climb onto a fitness system cover.
- Allow children to have unsupervised access to the fitness system.

AVOIDING THE RISK OF ELECTROCUTION

DANGER - RISK OF ELECTROCUTION

- Connect only to a grounded source.
- Do not bury the power cord. A buried power cord may result in death, or serious personal injury due to electrocution if direct burial-type cable is not used, or if improper digging occurs.
- A ground terminal (pressure wire connector) is provided on the control box inside the unit to permit connection of a minimum No. 6 AWG (16 mm²) solid copper bonding conductor between this point and any metal equipment, metal water pipe, metal enclosures of electrical equipment, or conduit within five feet (1.5 m) of the unit as needed to comply with local requirements.
- Do not connect any auxiliary components (for example, cable, additional speakers, headphones, additional audio components) to the audio system unless approved by Watkins Wellness

NO DIVING

Danger: Diving may result in serious injury or death.



- Do not self service the audio component by opening or removing fitness system door panel as this may expose dangerous voltage or other risk of injury. Refer all servicing to qualified service personnel.
- Do not attach an external antennae to a fitness system audio system unless installed by a licensed electrician in accordance with Article 810 of the National Electric Code, ANSI/NFPA 70.

WARNING

- To reduce the risk of electrical shock, replace a damaged cord immediately. Failure to do so may result in death or serious personal injury due to electrocution.
- Your fitness system is provided with a Ground Fault Circuit Interrupter (GFCI) for user and equipment protection. To ensure proper operation of this important safety device, test according to the following instructions:
 - A ground terminal is provided inside the junction box. To reduce the risk of electric shock, connect this terminal to the grounding terminal of your electrical service or supply panel with a continuous green, insulated copper wire. The wire must be equivalent in size to the circuit conductors supplying the equipment. In addition, a bonding terminal (pressure wire connector) is provided on the outside of the control box/heater for bonding to local ground points. To reduce the risk of electric shock, this connector should be bonded with a No. 6 AWG solid copper wire to any metal ladders, water pipes, or other metal within 5 feet (1.5 m) of the fitness system to comply with local requirements. The means of disconnection must be readily accessible, but must be installed at least 5 feet (1.5 m) from the fitness system.
 - Your fitness system is provided with a suitably rated circuit breaker to open all ungrounded supply conductors.
 - Your fitness system uses ground fault circuit interrupters in the electrical subpanel. Before each use of the fitness system and with the unit operating, push the TEST button on each breaker. The switch should click over to the "Trip" position. Wait 30 seconds and reset each GFCI breaker by switching it completely off and then completely on. The switch should then stay on. If either of the interrupters does not perform in this manner, it is an indication of an electrical malfunction and the possibility of an electric shock. Disconnect the power until the fault has been identified and corrected.

DANGER - RISK OF ELECTRICAL SHOCK

- Install at least 5 feet (1.5 m) from all metal surfaces. A fitness system may be installed within 5 feet (1.5 m) of a metal surface if each metal surface is permanently connected by a minimum No. 8 AWG solid copper conductor attached to the wire ground connector on the heater terminal block that is provided for this purpose.
- Install your fitness system in such a way that drainage is away from the electrical compartment and from all electrical components.
- Do not permit any electrical appliances, such as a light, telephone, radio, or television within 5 feet (1.5 m) of a fitness system. Failure to maintain a safe distance may result in death, or serious personal

injury due to electrocution, if the appliance should fall into the fitness system.

DO:

- Be sure your fitness system is connected to the power supply correctly - use a licensed electrical contractor.
- Disconnect the fitness system from the power supply before draining the fitness system or servicing the electrical components.
- Test the Ground Fault Circuit Interrupter(s) before each use.
- Replace audio components only with identical components (if your fitness system is equipped with an audio component).

DON'T:

- Use the fitness system with the equipment compartment door removed.
- Place electrical appliances within 5 feet (1.5m) of the fitness system.
- Use an extension cord to connect the fitness system to its power source. The cord may not be properly grounded and the connection is a shock hazard. An extension cord may cause a voltage drop, which will cause overheating of the jet pump motor and motor damage.
- Attempt to open the electrical control box. There are no user serviceable parts inside.

RISKS TO AVOID

DANGER - RISK OF INJURY

- To reduce the risk of injury to persons, DO NOT remove suction fittings (filter standpipes) located in the filter compartment.
- The suction fittings in the fitness system are sized to match the specific water flow created by the pump. Never replace a suction fitting with one rated less than the flow rate marked on the original suction fitting.
- There is a danger of slipping and falling. Remember that wet surfaces can be very slippery. Take care when entering or exiting the fitness system.
- Never operate fitness system if the suction fittings are broken or missing.
- People with infectious diseases should not use the fitness system.
- Keep any loose articles of clothing, long hair, or hanging jewelry away from rotating jets or other moving components. Long hair should be tied up or placed under a bathing cap.
- Safe water temperature for aquatic exercise is approximately 85°F (29.5°C).
- DO NOT use this fitness system alone.

INCREASED SIDE EFFECTS OF MEDICATION

- The use of drugs or alcohol may cause unconsciousness with the possibility of drowning.
- Persons using medications should consult a physician before using a fitness system; some medication may cause a user to become drowsy, while other medication may affect heart rate, blood pressure, and circulation.
- Persons taking medications which induce drowsiness, such as tranquilizers, antihistamines, or anticoagulants should not use the fitness system.

HEALTH PROBLEMS AFFECTED BY FITNESS SYSTEM USE

- Pregnant women should consult a physician before using fitness system.
- Persons suffering from obesity, or with a medical history of heart disease, low or high blood pressure, circulatory system problems, or diabetes should consult a physician before using fitness system.

UNCLEAN WATER

- Keep the water clean and sanitized with correct chemical care. The recommended levels for your **ENDLESS POOLS** fitness system are:

Free Available Chlorine: 1.0-5.0 ppm	Total Alkalinity: 80-120 ppm
Water pH: 7.2-7.8	Calcium Hardness: 75-150 ppm

- Refer to Water Quality and Maintenance section for complete instructions.

IMPORTANT: Turn on the jet pump for a least ten minutes after adding ANY fitness system water chemicals into the filter compartment.

Clean the filter cartridges monthly to remove debris and mineral buildup which may affect the performance of the hydromassage jets, limit the flow, or trip the high limit thermostat, which will turn off the entire fitness system.

AVOIDING THE RISK OF HYPERTHERMIA

Prolonged immersion in hot water can result in HYPERTHERMIA, a dangerous condition which occurs when the internal temperature of the body reaches a level above normal 98.6°F (37°C). The symptoms of hyperthermia include unawareness of impending hazard, failure to perceive heat, failure to recognize the need to exit the fitness system, physical inability to exit the fitness system, fetal damage in pregnant women, and unconsciousness resulting in a danger of drowning.

WARNING

The use of alcohol, drugs, or medication can greatly increase the risk of fatal hyperthermia in fitness systems.

TO REDUCE THE RISK OF INJURY

- The water in the fitness system should never exceed 99°F (37.5°C). Water temperatures between 79°F and 99°F (26°C and 37.5°C) are considered safe for a healthy adult. The lower water temperatures are recommended for extended use (exceeding ten minutes) and for young children. Extended use can cause hyperthermia.
- Pregnant or possibly pregnant women should limit fitness system water temperatures to 85°F (29.5°C) consult a physician prior to using this product. Failure to do so may result in permanent injury to your baby.
- Do not use fitness system having water temperatures over 100°F (36°C) immediately following strenuous exercise.
- Keep all breakables, especially glass, away from this fitness system.

- Never insert any objects into any openings.
- Keep all chemicals away from children and pets.
- DO NOT stack chemicals on top of one another.
- NEVER MIX CHEMICALS.
- Sanitizing chemicals must be stored separately from balancing chemicals.

AVOIDING THE RISK OF SKIN BURNS

- To reduce the risk of injury, before entering a fitness system the user should measure the water temperature with an accurate thermometer.
- Test the water with your hand before entering the fitness system to be sure it's comfortable.

SAFETY SIGN

Each **ENDLESS POOLS** fitness system is shipped with a SAFETY SIGN in the owner's package. The sign, which is required as a condition of Product Listing, should be permanently installed where it is visible to the users of the fitness system. To obtain additional SAFETY SIGNS, contact your **ENDLESS POOLS** dealer. Safety labels that are affixed to the shell are intended to be permanent and should not be removed.

OPTIONAL TREADMILL SAFETY INFORMATION

WARNING:

- Consult a physician before you start an exercise program. Stop exercising if you feel pain or tightness in your chest, become short of breath, or feel faint. Contact your doctor before you use the machine again.
- This machine contains moving parts. Do not wear loose clothing or jewelry.
- Do not put fingers or other objects into moving parts of the exercise equipment.
- Use caution while participating in other activities while walking on your treadmill; such as watching television, reading, etc. These distractions may cause you to lose balance or stray from walking in the center of the belt; which may result in serious injury.

WARNING: TO AVOID THE RISK OF INJURY

- Pregnant women should always consult a physician prior to starting an exercise program.
- NEVER operate this treadmill without reading and completely understanding the results of any operational change you request from the controller.
- Treadmill must be installed on a smooth and level surface.
- NEVER leave an operating treadmill unattended.
- NEVER mount or dismount the treadmill while the belt is moving.
- Hydraulic treadmills start at a very low speed and it is unnecessary to straddle the belt during startup. Simply standing on the belt during this slow acceleration is the proper way to start using this product.
- Always hold on to a handrail or grab bar while making control changes.
- Never drop or insert any object into any openings.
- Children must be supervised while using this machine.
- The moving parts and other features of the machine can be dangerous to children.

- Before each use, examine this machine for damage or signs of wear. Do not use this product if found in this condition. Call Customer Service for repair information.

IMPORTANT FITNESS SYSTEM INSTRUCTIONS

The following contains important fitness system information, and we strongly encourage you to read and apply them.

DO:

- Follow the fitness system Care and Maintenance recommendations stated in this manual.
- Use only approved accessories and recommended fitness system chemicals and cleaners.

DON'T:

- Leave the fitness system exposed to the sun without water or a cover in place. Exposure to direct sunlight can cause solar distress of the shell material.
- Roll or slide the fitness system on its side. This will damage the siding.
- Lift or drag the vinyl cover by using the cover lock straps; always lift or carry the cover by using the handles.
- Attempt to open the electrical control box. There are no user serviceable parts inside. Opening of the control box by the fitness system owner will void the warranty. If you have an operational problem, carefully go through the steps outlined in the Troubleshooting section. If you are not able to resolve the problem, contact your authorized **ENDLESS POOLS** dealer. Many problems can easily be diagnosed over the telephone by an Authorized Service Technician.

FITNESS SYSTEM SHELL

Your fitness system has an acrylic shell. Stains and dirt generally will not adhere to your fitness system's surface. A soft rag should easily remove most dirt. Most household chemicals are harmful to your fitness system's shell (see below for detailed information on cleaning agents). Always rinse off any fitness system shell cleaning agent with fresh water.

IMPORTANT:

1. The following products are the **ONLY** approved cleaning agents for your fitness system shell: plain water, Brilliantize[®] or Soft Scrub[®]. The use of alcohol or any other household cleaner other than those listed to clean the fitness system shell surface is **NOT** recommended. **DO NOT** use any cleaning products containing abrasives or solvents since they may damage the shell surface, specifically: Simple Green[®], Windex[®] or spa Mitt. **NEVER USE HARSH CHEMICALS!** Damage to the shell by use of harsh chemicals is not covered under the warranty. Always rinse off any fitness system shell cleaning agent with fresh water.
2. Iron and copper in the water can stain the fitness system shell if allowed to go unchecked. Ask your **ENDLESS POOLS** dealer about a Stain and Scale Inhibitor to use if your fitness system has a high concentration of dissolved minerals.
3. Keep all cleaners out of the reach of children and use care when applying.

SAVE THESE INSTRUCTIONS

SITE REQUIREMENTS

Your fitness system must be installed on a smooth and level surface that can support the dead weight listed in the back of this manual.

If a new slab is poured, consult your local electrical codes regarding grounding and bonding. Local code may require a bonding wire to be attached to the reinforcing bar or wire mesh that is embedded in the concrete. If new concrete is being poured, this is the ideal time to install the conduit for the incoming electrical supply.

Even if a new pad has been poured, it is essential that the system site is level and planar. There is a simple way to ensure that this is the case. First, draw a chalk outline of the footprint of your fitness system. Place a six-foot level along and around the footprint of the system. Verify that there are no gaps between the level and floor. Next pour water inside of the chalk footprint. Verify that the water does not puddle inside the footprint.

Should there be a gap or should the water puddle inside the footprint, call your **ENDLESS POOLS** dealer prior to continuing to discuss the best way to resolve this situation.

INDOOR CONSIDERATIONS

- Local electrical and plumbing codes.
- Ventilation fans and/or dehumidifiers should be provided to handle the humidity developed by your fitness system. Walls, ceiling and wood trim should be water resistant, also.
- Chemicals will vaporize from the water and may cause an odor and possibly corrosion to certain home hardware. Never store chemicals inside the fitness system cabinet.
- During the normal use of the fitness system, water will escape the vessel. Never place on or over any materials, which may be damaged by this water or the chemicals within the water. Keep damageable materials far enough away to avoid water damage, even if the fitness system should lose all its water.
- Consider and prepare for the unlikely event of rapid drainage. If placement of the fitness system is permanent, you may wish to provide floor drains to accommodate draining, etc. Always leave room all around the fitness system for easy access in case repairs are necessary.
- Consider and prepare for the unlikely event of removal.
- Do not set fitness system on finished floor without a waterproof barrier protection underneath.
- The fitness system should have access to a power source capable of supplying 230 volts AC power. It must be wired directly into a grounded circuit with a ground fault circuit interrupter (GFCI). No other appliances should be on the same circuit.
- The fitness system should be close to a source of water.
- Be sure that the location you choose is stable. It must be able to support the weight of the fitness system when it is filled with water, plus the weight of the occupants. The fitness system may weigh up to 25,258 lbs (11,457 kg) when it is filled with water.
- Do not use the fitness system above a finished living area due to the risk of water damage.
- The fitness system is not designed for in-floor installation. However, it is compatible with a deck system that is built flush with the bar top, provided you leave access for service.
- Be sure to note any other considerations, such as aesthetics or privacy concerns, that may affect the safety or enjoyment of using the fitness system.

OUTDOOR CONSIDERATIONS

- Local electrical and plumbing codes.
- Consider local codes pertaining to fencing, enclosures, walls, electrical and plumbing. You will need to ensure that your fitness system is an adequate distance from power lines, both above ground and underground. Your fitness system will also need to be child proofed.
- View from house for aesthetics and supervisory needs.
- Distance from house for wintertime soaking.
- Nighttime lighting.
- Consider sunlight exposure, views, access, property lines, lighting, wind direction, shielding, septic tanks, plants, and trees when determining your location. Chemicals in the fitness system water may splash damaging nearby plant life.
- Area for placement of support equipment where adequate space will be needed to gain access to components for maintenance and general servicing.
- Be sure to note any other considerations, such as aesthetics or privacy concerns, that may affect the safety or enjoyment of using the fitness system.
- Provide adequate drainage away from the equipment and adequate elevation to allow draining by siphon, if should be required.
- Location of electrical supply. 230-volt systems require hard wire installed from the main electrical source, to the sub panel, then to the fitness system terminal block. All equipment must be ground fault circuit protected. All electrical wiring must comply with the national electric code.
- Locations at least 5 ft (1.5 m) from all metal surfaces. A fitness system may be installed within 5 feet (1.5 m) of metals surfaces providing each metal surface is permanently connected by a #8 awg copper conductor attached to the bonding wire connector on the heater provided for this purpose. All installations must comply with article 680 of the U.S. national electric code and ANSI/NFPA 70-1984.
- Place the fitness system on a firm, level surface that will not shift.

ELECTRICAL REQUIREMENTS

IMPORTANT: Fill the fitness system with water before turning on the power.

Your **ENDLESS POOLS** fitness system has been carefully designed to give you maximum safety against electrical shock. Connecting the fitness system to an improperly wired circuit will negate many of the fitness system's safety features. Improper wiring may also cause electrocution, risk of fire, and other risks of injuries. Please read and follow the electrical installation requirements and instructions completely!

IMPORTANT: Please see **ELECTRICAL NOTE** on back cover for additional information.

230 VOLT CONNECTED (STANDARD)

ENDLESS POOLS fitness systems must be wired in accordance with all applicable local electrical codes. All electrical work should be done by an experienced, licensed electrician. We recommend the use of appropriate electrical conduit, fittings, and wire for all circuits.

The diagram below illustrates how to wire the fitness system model:

- An electrical subpanel containing two 30 Amp breakers is included with your fitness system. We recommend that this subpanel be used to supply power to the fitness system.
- The subpanel requires a 60 amp, single phase, 230 volt, four wire service (two line, one neutral, one ground). The grounding conductor must not be less than #6 AWG. Refer to local codes and to NEC 250-122 (table).
- Mount subpanel in the vicinity of the fitness system, but not closer than five feet away, in accordance with all local codes. (N.E.C. 680-38 to 41-A-3).

IMPORTANT: If you ever need to move or relocate your **ENDLESS POOLS** fitness system, it is essential that you understand and apply these installation requirements. Your **ENDLESS POOLS** fitness system has been carefully engineered to provide maximum safety against electric shock. Remember, connecting the fitness system to an improperly wired circuit will negate many of its safety features.

NOTE: Long wiring runs may require larger-gauge wire than stated.

- Open fitness system by removing the 4 screws holding the vertical T-spacer located in the center of the equipment compartment (back side of fitness system). Slide panel towards center, raise panel, pull bottom out, lower, disconnect light wires on both side and remove, repeat for other panel.
- Insert power wires into fitness system from either side towards the bottom, you will find a plastic cap attached to wall.
- Once your fitness system has been filled with water, turn it on and test all of the circuit breakers.

IMPORTANT: If breakers immediately trip, verify that the wires are correctly connected. Breaker should be tested prior to each use. Here's how:

1. Push the "TEST" button on each GFCI breaker, and observe it click OFF.
2. Wait 30 seconds, then push the breaker switch to the OFF (down) position (to ensure that it has completely disengaged), then push the breaker switch to the ON (up) position. If you don't wait 30 seconds, the fitness system's power indicator may continue to blink – try again.

If any of the GFCI breakers fails to operate in this manner, your fitness system may have an electrical malfunction, and you may be at risk of electrical shock. Turn off all circuits and do not use the fitness system until the problem has been corrected by an authorized service agent.

⚠ WARNING: Removing, or bypassing any GFCI breaker will result in an unsafe fitness system and will void the fitness system's warranty.

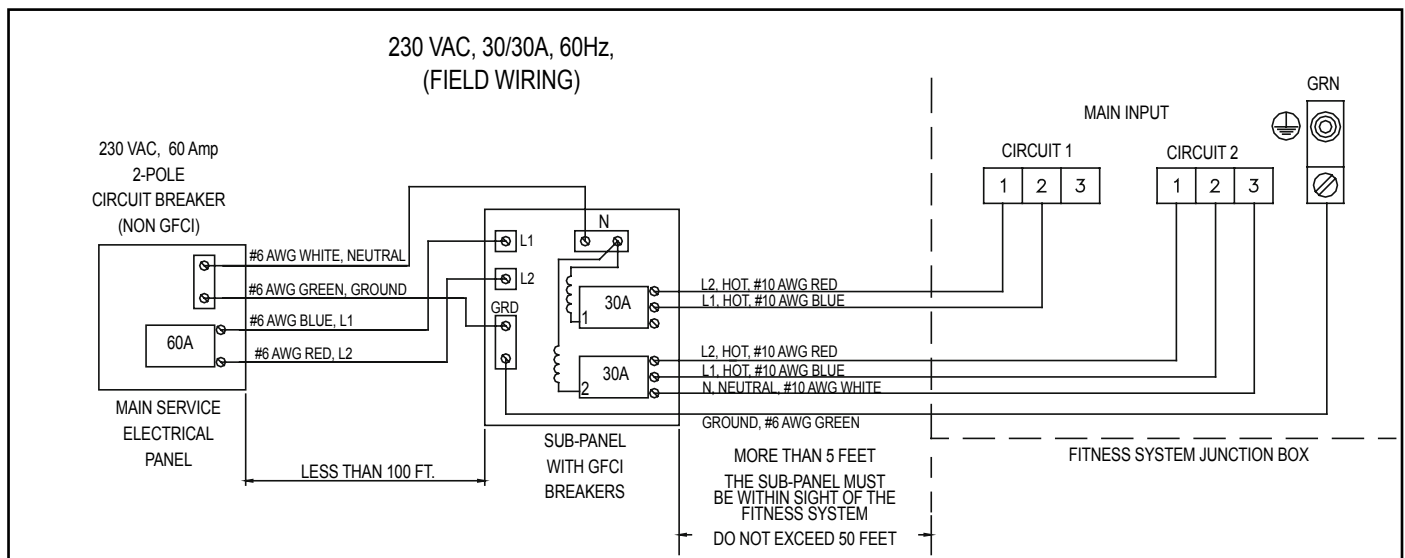

CAUTIONS

USE COPPER CONDUCTORS ONLY.
USE SUPPLY WIRES SUITABLE FOR 75°C/167°F.
DISCONNECT ALL SUPPLY CONNECTIONS BEFORE SERVICING.
CONNECT ONLY TO A CIRCUIT PROTECTED BY A CLASS A
GROUND-FAULT INTERRUPTER.

THESE FITNESS SYSTEMS ARE INTENDED FOR USE WITH GFCI
SUBPANEL PROVIDED.
INCORRECT WIRING WILL DAMAGE CIRCUIT BOARDS.
REFER TO THE WIRING INSTRUCTIONS INCLUDED WITH THE
SUB-PANEL FOR DETAILED WIRING INSTRUCTIONS.

EQUIPMENT COMPARTMENT

The illustrations below are to be used as a reference only (your fitness system may look different). The equipment compartment is located behind the hydromassage seats (back of the fitness system) for the E500 & E700 and below the Control Panel on the front left side for the E550.

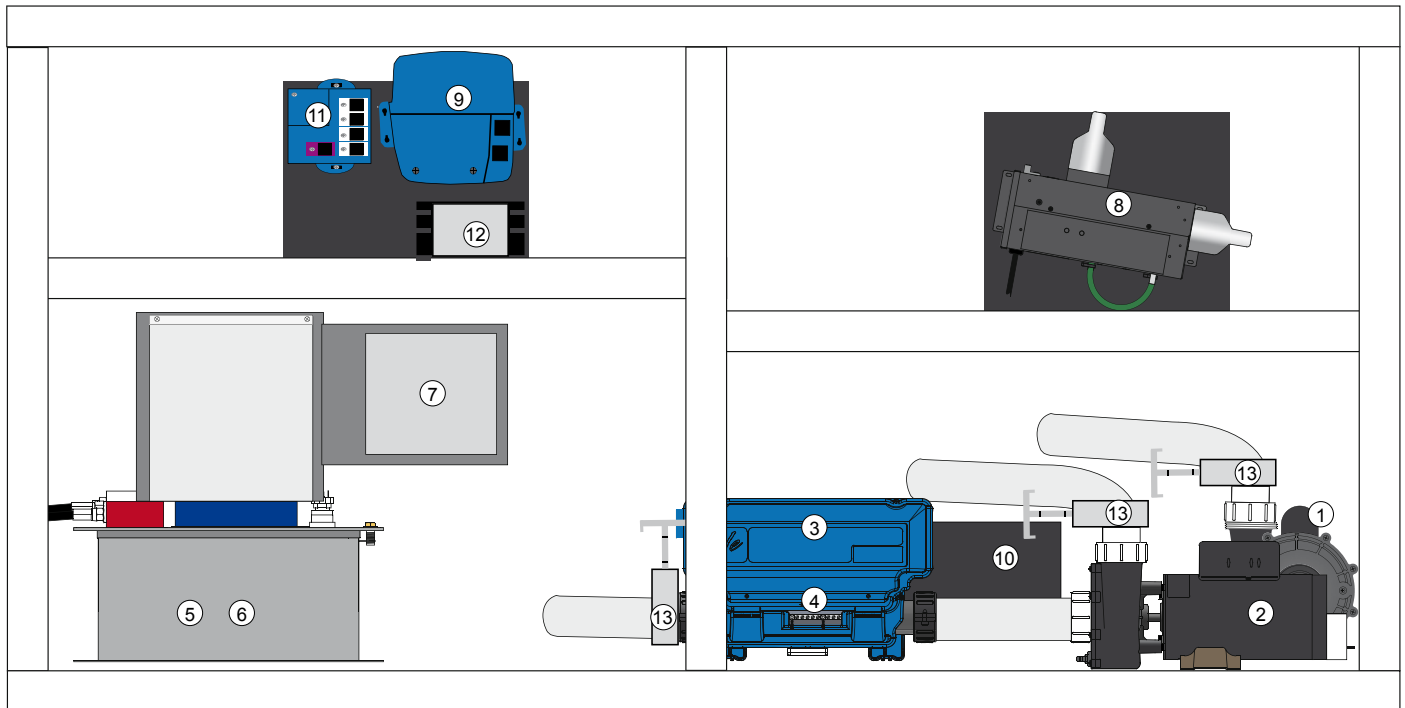

- | | | |
|---|--|--|
| 1. Hydromassage Jets pump | 6. Treadmill Hydraulic Unit (Optional tandem unit used for both 5 & 6) | 10. Subwoofer (optional) |
| 2. Circulation Pump | 7. Junction Box | 11. Wi-Fi (optional) |
| 3. Control Box & Heater | 8. UV-C Ozone | 12. Dual Output Power Supply for External lights |
| 4. Bonding terminal | 9. Bluetooth Music (optional) | 13. Isolation Valve |
| 5. Swim Machine Hydraulic Unit (smaller than illustrated) | | |

DOOR PANEL REMOVE & REPLACE

REMOVE

1. Locate the vertical T-spacer in the center of the equipment compartment (back side of fitness system or front left side under control panel for E550 model).
2. Remove the 4 screws (using a 5/16" [8 mm] socket) holding the T-spacer then remove the T-spacer.
3. Slide panel towards center until panel is no longer behind corner.
4. While holding panel, first pull panel up then pull bottom away from **ENDLESS POOLS** Fitness system, lower panel and set on ground. Disconnect light bar wires from each side of panel and remove.
5. Repeat for other side.



Disconnect Light bar wires (see steps A-D above)

REPLACE

1. Reconnect light bar wires.
2. Raise panel making sure it goes behind the bar top and rest on bottom frame.
3. Slide panel behind corner.
4. Replace other side panel using steps 1 & 2.
5. Attach T-spacer back in place using 4 screws to complete the installation.



GETTING STARTED

E500 & E700 FITNESS SYSTEM FEATURES

Your fitness system may look different than the illustration



1) The **control panel** provides a quick visual check of the fitness system's status and allows the user to set different functions of the fitness system.



2) The **Aux panel** allows you to control the Hydromassage jets, interior and exterior lights.



3) The **Air Valve** allows you to add air to your hydromassage jets.



4) The **Water Feature Lever** adjusts the amount of water that flows from the water feature.



5) The **Large Hydromassage jets** provide a unique, pulsating massage.



6) The **Midsize Directional Hydromassage jets**, with eyeball nozzles, deliver a direct, more focused massage.



7) The **Midsize rotational Hydromassage jets**, provide a rotating massage.



8) The **Mini Hydromassage jets** feature a direct more focused massage.



9) The **Hydraulic Swim Machine** uses a remote control to adjust the speed of the current.



10) The **Hydraulic Treadmill (Optional)** uses a remote control to adjust the speed of the treadmill.



11) Pillow



12) Filter Compartment Grill



ADDITIONAL FITNESS SYSTEM FEATURES

13) Swim Speaker (Optional)

19) Grab Rails

14) Seating area Speaker (Optional)

20) Points of light

21) Exercise Anchor

15) Suction Screen

22) Tether Anchor

16) Water feature

17) Ozone Jet

18) Heater Return

E550 FITNESS SYSTEM FEATURES



1) The **control panel** provides a quick visual check of the fitness system's status and allows the user to set different functions of the fitness system.



2) The **Air Valve** allows you to add air to your hydromassage jets.



3) The **Large Hydromassage jets** provide a unique, pulsating massage.



4) The **Midsize rotational Hydromassage jets**, provide a rotating massage.



5) The **Mini Hydromassage jets** feature a direct more focused massage.



6) The **Hydraulic Swim Machine** uses a remote control to adjust the speed of the current.



7) The **Hydraulic Treadmill (Optional)** uses a remote control to adjust the speed of the treadmill.



ADDITIONAL FITNESS SYSTEM FEATURES

- | | |
|----------------------------------|------------------------------|
| 8) Front Swim Speaker (Optional) | 13) Grab Rails |
| 9) Back Speakers (Optional) | 14) Filter Compartment Grill |
| 10) Suction Screen | 15) Points of light |
| 11) Ozone Jet | 16) Exercise Anchor |
| 12) Heater Return | 17) Tether Anchor |

HYDROMASSAGE JETS

LARGE HYDROMASSAGE Jets - This jet provides a unique, pulsating massage. The water flow is adjustable in that it can be turned from low to high (by rotating the jet faceplate ¼ turn).



MIDSIZE DIRECTIONAL JET - These jets allow you to redirect the jet stream by changing the position of the nozzle. The water flow is adjustable in that it can be turned from low to high (by rotating the jet faceplate ¼ turn).

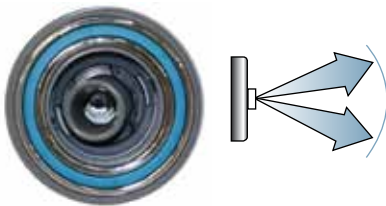

MIDSIZE ROTATIONAL JET - These jets provide a rotating massage pattern. The water flow is adjustable in that it can be turned from low to high (by rotating the jet faceplate ¼ turn).

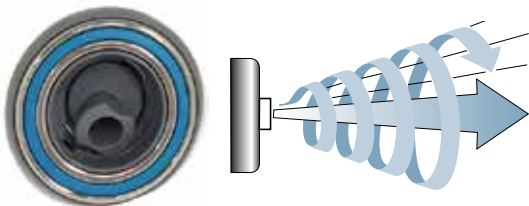

Mini JET - These jets deliver a direct, more focused massage. The water flow is adjustable in that it can be turned from low to high (by rotating the jet faceplate ¼ turn).

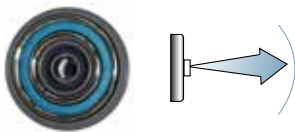

WATERFALL VALVE (E500 & E700)

Your fitness system may be equipped with a waterfall feature. It is activated by turning on the hydromassage jets (either low or high speed). The flow is regulated by turning the waterfall valve on the inside wall of the fitness system.



AIR CONTROLS

Your fitness system is equipped with two air valves. The air valves will add or remove air to the hydromassage jet system. Rotate valve to see which hydromassage jets are affected.



SWIM MACHINE-HYDRAULIC

SWIM MACHINE OPERATION - Two teal remote controls have been provided with your system and have been packaged in the owner's packet inside the equipment compartment labeled.



The swim machine is turned on through the use of the remote control, which also adjusts the speed of the current faster or slower. When changing speed, you must press and hold the buttons on the remote, then wait

a few seconds for the current to adjust. Upon initial start-up you will find that the unit has been set to its lowest speed; which is a barely perceptible current. You will need to press and HOLD the FASTER button to increase the speed. The standard top speed is roughly equivalent to a 1:08 100 yard pace (1:14/100 meters) a speed for expert swimmers only. Set the water speed at a comfortable level for your needs. Remotes are water resistant but can not be submerged.

To stop swimming, simply press the on/off button on the remote. If left running, the power unit will turn off automatically after **thirty minutes** and can be restarted by pressing the on/off button again. Once you have found an optimal speed for yourself, you may leave the system at that setting. The controller for the swim machine is designed with a "ramp-up" feature which forces the swim machine to start slowly, but will increase to the last setting at which someone swam.

When you are first learning to swim in the swim current, it is often useful to allow yourself to drift back to the rear of the fitness system. Let your feet rest on the rear seat and then swim forward into position. By starting from the back, you can get a feel for just how much room you have. When swimming, center your outstretched arm about one foot from the front grill.

TREADMILL-HYDRAULIC (OPTIONAL)

TREADMILL OPERATION - Two grey remote controls have been provided with your system and have been packaged in the owner's packet inside the equipment compartment. These remotes are identical to the swim machine remotes but a different color.



Upon initial start-up you will find that unit has been set to its lowest speed. You will need to press and HOLD the FASTER button to increase the speed.

The treadmill is turned on through the use of a remote control, which also adjusts the speed of the treadmill faster or slower. When changing speed, you must press and hold the buttons on the remote, then wait a few seconds for the treadmill to adjust. Set the speed at a comfortable level for your needs. Remotes are water resistant but can not be submerged.

NOTE: Depending on duration, temperature, and speed, users may experience slight pulsing when the treadmill is operated on the slowest speed settings. This action is caused by the natural rotation of the hydraulic motor and will lessen as the treadmill speed is increased.

To turn off the treadmill, simply press the on/off button on the remote. If left running, the power unit will turn off automatically after **thirty minutes** and can be restarted by pressing the on/off button again. The treadmill will always default to the slowest speed when turned on.

When you are first learning to use the treadmill in conjunction with the swim machine, it is best to start at the lowest speeds for both the swim machine and treadmill. The added resistance the swim machine may allow for a slower treadmill speed than initially thought.

IMPORTANT: Do not use treadmill when circulation pump is OFF.

PACE DISPLAY (OPTIONAL)

SWIM PACE DISPLAY - For any **ENDLESS POOLS**® product that generates a swim current the default setting for the display is 100 yard pace (shown as minutes:seconds). This indicates the water flow equivalent of swimming 100 yards in a traditional lap pool in the indicated amount of time. Swim current units can also be for

a 100 meter pace. As the current speed is increased, the value the display reads goes down, since the faster you swim the less time it takes to swim 100 yards (100 meters). Any Pace Display can be set for a percentage of 2-100.



TREADMILL PACE DISPLAY - For the optional hydraulic treadmill the default setting for the display is miles per hour. The pace can be also be converted to display kilometers per hour. Unlike a swim current display, as the speed of the treadmill is increased, the value on the display will also increase. Any Pace Display can be set for a percentage of 2-100.



QUICK START-UP INSTRUCTIONS

BEFORE YOU FILL YOUR FITNESS SYSTEM

Make sure your fitness system has been properly installed per all local codes, including the location of the fitness system, the foundation of the fitness system, as well as the electrical installation of the fitness system.

DO:

- Know which water treatment system you will be using and make sure you have necessary chemicals available. Read all of the instructions that come with the system.
- Have 5-way Test Strips Available.
- Have pH/Alkalinity Up & Down available.
- Know the Hardness of your water, contact your dealer to help you with this information. See Water Quality and Maintenance for more information.
- Purchase the Clean Screen® pre-filter to remove unwanted contaminants from the tap water. This is recommended, not required.

START-UP

Your **ENDLESS POOLS** fitness system has been thoroughly tested during the manufacturing process to ensure reliability and long-term customer satisfaction. A small amount of water may have remained in the plumbing after testing and, as a result, may have spotted the fitness system shell or the fitness system siding prior to delivery. Before filling the fitness system, wipe the fitness system shell clean with a soft rag. The following instructions must be read and followed exactly to ensure a successful start-up or refill.

CAUTIONS

- **DO NOT CONNECT POWER TO AN EMPTY fitness system.** Power to the fitness system automatically activates critical components within the fitness system, such as controls, heater, and other systems. If power is supplied to these components prior to the fitness system being filled, the components will be damaged, and this may result in a non-warranty component failure.
 - **DO NOT** use your fitness system after filling until all of the steps listed below are completed.
 - **DO NOT** add chlorine if treating your fitness system with polyhexamethylene biguanide (Biguanide, PHMB, eg. BaquaSpa®) sanitizer.
 - **DO NOT** use a salt-generated chlorine system, this will damage components and is not covered under your warranty.
 - Before filling your fitness system for the first time, remove the equipment compartment door and check to ensure that the unions on either side of the pump(s) and heater are hand-tight and the slide valves are open.
1. **CLOSE DRAIN, remove the filter compartment grill skimmer tray and one filter (pg. 21).** Fill your fitness system through the filter compartment using the CleanScreen™ pre-filter (optional from dealer) that attaches to your garden hose. The water level of your fitness system should be maintained at a level 6" (15 cm) below the top of the fitness system. Reinstall the filter, skimmer tray, and grill once the fitness system is filled.
IMPORTANT: *Watkins Wellness does not recommend that the fitness system be filled with "softened" water, as this may damage the fitness system's equipment.*
 2. **AFTER THE FITNESS SYSTEM HAS BEEN FILLED** with water and the equipment compartment door is secured, power must be applied to the fitness system.
 - **FIRST** activate power to the subpanel from the main house panel.
 - **NEXT** open the door of the electrical subpanel and reset the GFCI breakers.
 - **FINALLY**, close and secure the subpanel door.

3. **TO CHECK THE OPERATION OF THE HYDROMASSAGE JET SYSTEM** and to purge any remaining air from the system complete the following steps:
 - Press the jets button placing all hydromassage jets on High.
 - Once the jet system is fully operational (as indicated by strong, non-surgling jets), priming of the fitness system is complete.
 - To turn off the jets, press the jets button on the main control panel.
 - If you do not feel a steady stream of water from your jets, refer to the instructions for priming the pump in the fitness system TROUBLESHOOTING section.
4. **SET THE TEMPERATURE CONTROL** to the desired temperature between 59°F (15°C) and 99°F (37°C), then place the optional fitness system cover on the fitness system and allow the water temperature to stabilize approximately 1°F (0.5°C) per hour. Make sure you secure the cover in place. Periodically check the fitness system water temperature. When the water temperature reaches desired temperature, proceed to the next step. The fitness system temperature is pre-programmed to reach 85°F (29.5°C). You may change the water temperature by pressing the ▲ button on the control panel to raise the temperature, or lower temperature by pressing the ▼ button.
5. **USING A TEST STRIP AND APPLICABLE CHEMICALS** adjust Total Alkalinity (TA) to 80-120 ppm, Calcium Hardness (CH) to 75-150 ppm, then fitness system water pH to between 7.2 and 7.8. These procedures are listed in the “Water Quality and Maintenance” section.

OPERATION NOTE: *Adjusting the Total Alkalinity as the first step is important, as out-of balance TA will affect your ability to adjust the pH correctly and will prevent the sanitizer from operating effectively.*

IMPORTANT: *Activate the swim machine by using the blue swim machine remote and increase speed to at least 50% before adding chemicals. Disperse the chemicals in the swim area away from the walls.*

6. **SUPERCHLORINATE THE FITNESS SYSTEM WATER** by adding 1½ teaspoons of chlorine (sodium dichlor) per 250 gallons (950 liters) of water while running the swim machine above 50% for 10 minutes. Disperse the chemicals in the swim area away from the walls.
7. **TEST THE FITNESS SYSTEM WATER FOR CHLORINE RESIDUAL.** If the residual is between 1 and 5 ppm on the test strips, go on to the next step. If the residual is less than 1 ppm, activate the swim machine above 50% for another 10 minutes and add more chlorine as needed, then retest.

WARNING: *High sanitizer levels can cause discomfort to the user's eyes, lungs and skin. Always allow the sanitizer level to fall to the recommended range before using the fitness system.*

8. **RECHECK** the Total Alkalinity (TA) 80-120 ppm, Calcium Hardness (CH) 75-150 ppm, and the pH must be between 7.2 and 7.8.

The fitness system is ready for use when the fitness system water has circulated and the bromine level remains between 1 and 2 ppm or chlorine level remains between 1 and 5 ppm.

OPERATING INSTRUCTIONS

MAIN CONTROL PANEL

The main control panel provides a bright, full color display, and intuitive user experience, while its screen's high resolution brings fitness system user interfaces to a new level. Loaded with a large amount of memory and a powerful on-board processor creating seamless graphic interface that fitness system users have been waiting for.



MAIN CONTROL PANEL FUNCTIONS

When the screen is off, press any button to turn the control panel screen on and display the home screen. After 30 minutes of inactivity the screen will shut off.

The function description of the buttons below will only work from the Home screen. Once the main control panel is placed in a submenu the selection lights next to the buttons will light up to indicate which buttons may be selected for a specific screen function.

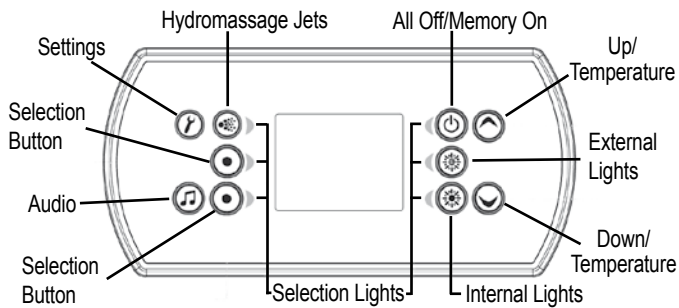

SETTINGS

One press of the (Settings button) from the home page gives you access to a menu to manage the settings of your fitness system where you will find:

- Water care
- Audio (optional)
- Maintenance
- Date and time
- Keypad Settings
- Miscellaneous
- Wi-Fi (optional)
- Electrical configuration
- About



Use the or buttons to move up and down in the list. To select an option, press the lit button beside the desired highlighted option.

IMPORTANT: At any point you can press the (Settings button) to return to the home screen or top left button (hydromassage jets) to go back.

WATER CARE / HEATER SETTINGS

The Water Care section will help you set up your ideal heater settings. Choose from Away from Home, Standard, Energy Savings, Super Energy Savings, and Weekender, depending on your needs.



Use (middle left) button to choose your setting. A green check mark will appear on the selected icon to confirm.

When in Economy mode, the heating set point will be reduced by 20°F (11°C), which means that the heating system will not come on during the set time unless the temperature falls 20°F (11°C) below the fitness system's set temperature.

Because the fitness system uses a 24 hour circulation pump there are no filter cycle settings, however, the hydromassage jet pump will purge for 1 minute (Purge time) two times per day. The Purge times may be changed however the duration is fixed at 1 minute.

WATER CARE MODES

Away from home:
 In this mode the fitness system will always be in economy mode; the set point will be reduced by 20°F (11°C).

Standard:
 The fitness system will never be in economy mode.

Energy Savings:
 The fitness system will be in economy mode during the peak hours of the day and resume normal mode on the weekend.

Super Energy:
 The fitness system will always be in economy mode during peak hours, every day of the week.

Weekender:
 The fitness system will be in economy mode from Monday to Friday, and will run normally on the weekend.

Default Settings:
 By selecting this setting you will be asked to confirm your choice. Doing so will revert all Water Care Modes back to factory settings.

MODIFYING SCHEDULES



To modify a Water Care category, use the (middle right) lit button, to open the selected Water Care menu. The menu screen is divided into two settings, Economy and Purge Time with Economy being first. Set or change the Day, Start and Stop time if desired to keep the heater off

(Economy mode). Scroll down to set or change the Purge Time Day and Start time keeping in mind that this will only set a 1 minute purge cycle (duration is not changeable).



You can add schedules by scrolling down to Add, and selecting by using the (middle left) lit button.

To delete a highlighted schedule, press (top right) lit button.

You can modify the schedules by selecting (middle left) lit button and adjusting the schedule using the or buttons. Press (middle left) lit button to move between parameters.

You have several possibilities for the schedule (Mon-Fri, weekend, every day, or single days). The schedules will be repeated every week. Once you have set the schedule, use (top left) lit button to go back. Ensure that you have selected the desired Water Care option in the main Water Care menu.

MAINTENANCE

From the Settings page you can access the Maintenance menu, which gives you access to the following options:

- Maintenance reminders
- Standby



Use the or buttons to make a selection, and (middle left) lit button to select.

MAINTENANCE REMINDERS

The control panel will remind you of maintenance required on your fitness system, like rinsing or cleaning the filter. Each task has its own duration, based on normal use.

The Maintenance reminders menu allows you to verify the time left before maintenance is required, as well as to reset the time once a task is completed.

Use the or buttons to move through the list.

To reset a task select it by pressing the (middle left) lit button, then confirm by pressing the lit button next to confirm when prompted. Once you have confirmed the task will be reset.



STANDBY

The Standby mode allows you to service your fitness system. Pumps will stop for 30 minutes, and automatically restart after this time. Press (middle left) lit button to activate Standby mode.



Once Standby mode has been activated a screen will appear to show that pumps are stopped. The normal fitness system page will return at the end of maintenance.

Press on the button next to cancel to leave Standby mode and restart the fitness system.

DATE AND TIME

Here you can adjust the time format, change the year, date, and time. Use the or buttons to choose the setting that you want to adjust, and select it by pressing (middle left) lit button.



Use the or buttons to change the parameters, and (middle left) lit button to move between parameters. Press (top left) lit button to take you back to the main Settings menu.

KEYPAD SETTINGS

In this section, you can change the temperature unit, language, display orientation, rim around the control panel light color, and lock the control panel.



Use the or buttons to choose the setting that you want to adjust. Select it by pressing the (middle left) lit button then use the or buttons again to change the setting.

When you change the display orientation, the contextual options and or buttons adjust to the chosen orientation. The Audio and Setting buttons remain unchanged, as well as the jets and lights buttons in the home page.

Security settings allow you a Partial (Temperature) lock or Full (entire control panel) lock. Select Security screen by pressing the (middle left) lit button then use the or buttons to change to Full, Partial or Unlock. Press (top left) lit button to display an information screen telling you to press and hold button for 5 seconds to lock.

To unlock Full, press and hold button for 5 seconds.

MISCELLANEOUS

You can turn the Warm weather mode ON or OFF. When ON the circulation pump will shut OFF whenever the water temperature gets 2°F (1°C) above the set point. Because of the fitness system's large body of water it is recommended to keep the Warm weather mode OFF.



Press the (middle left) lit button, then use the or buttons to change the Warm weather mode. **IMPORTANT:** Do not use treadmill (optional) when circulation pump is OFF.

You can also hide some information on the home screen by selecting Hide in "Info messages" (not recommended).

ELECTRICAL CONFIGURATION

Please do not make any changes to this screen!



ABOUT

This section shows information about the control panel software number, and the revision numbers of the different components of your system.





WI-FI (OPTIONAL)

This menu allows you to connect your in.touch module to a Wi-Fi network or to change its network. This menu is only visible when the in.touch module is installed.

To connect your in.touch module to a wireless network, use the  or  buttons to go to the Wi-Fi option in the Settings menu and  (middle left) lit button to select it.









After a few seconds the available networks will appear on the screen, as well as their signal strength.

Use the  or  buttons to move through the list. Select your network by pressing the middle left button (top swim jets).



If the Wi-Fi network is password protected enter it when prompted.

- Use the  or  buttons to choose your letters.
- Use  (lower right) lit button to move the cursor forward.
- Use  (top right) lit button to change the type of character. (uppercase, lowercase, number, symbol).
- Use  (lower left) lit button to backspace.
- Use  (middle left) lit button to confirm.

If no password is required the in.touch will connect automatically.









Once the in.touch module is connected to a Wi-Fi network a green check mark will appear in the Wi-Fi menu, and the network name will appear in the Settings menu.

AUDIO IN.STREAM 2 (OPTIONAL)

If your fitness system has the optional in.stream 2 Bluetooth w/subwoofer system the following screens and functions will be available on the control panel:

AUDIO

The main control panel is used with the in.stream 2 audio system. The Audio screen in the Settings menu gives you the option to disconnect your Bluetooth enabled device, adjust the Fader, Balance or Sub Woofer.

Use the  or  buttons to scroll to desired option, press  (middle left) lit button to select the function. Press the  or  buttons to change parameters. Press  (top left) lit button to take you back to the main Settings menu.



IN.STREAM 2 FUNCTIONS

Press the  button in the home screen to access your audio system.

If you are using a device with Bluetooth technology, it must be connected for functions to work.

Please note that the Play/Pause and Change Track functions apply to devices using Bluetooth technology only, and will NOT work when AUX is selected as the source.

Turning power on/off

Press the  (top right) lit button to start the audio on or off process.

Selecting the source



Press the  (top left) lit button to select a source using Bluetooth wireless technology or AUX (aux is not available at time of publication). Selection will be indicated below In.stream 2.





Pairing Bluetooth

Audio Power must be on. Go to the Bluetooth settings on your device and find in.stream 2 and press to connect. Enter pin 5555 and press pair to sync your device. **NOTE:** Only one device at a time can be synced.

Play/Pause audio

Press the Play/Pause  (middle right) lit button to start or pause the audio. Press  (middle left) lit button to mute or enable sound.

Adjusting the volume

Press the  or  buttons to increase or decrease the volume illustrated by the slider bar.

Changing tracks



Use the Last Track and Next Track  (lower left) lit button or  (lower right) lit button to change tracks.

TEMPERATURE CONTROL

The set temperature range is from 59°F to 99°F (15°C to 37.5°C). (The water temperature of any fitness system may rise or lower slightly depending on the current use and condition of your fitness system and on outside temperatures.)

The set temperature of the fitness system water will automatically be 85°F (29.5°C) the first time power is applied. This is the setting programmed at the factory. After the fitness system has been set up and used, the last temperature value set by the user will be stored in memory. If power is disconnected from the fitness system, it will automatically revert to the last set temperature when power is reapplied.

To display the set temperature of the fitness system:

Press the  or  buttons on the control panel in the home screen.

To increase the set temperature of the fitness system:

Press the  button in the home screen. The set point will appear in blue. After 3 seconds without any change to the set temperature value, the current water temperature will reappear in white.



To decrease the set temperature of the fitness system:

Press the  button in the home screen. The set point will appear in blue. After 3 seconds without any change to the set temperature value, the current water temperature will reappear in white.

JETS CONTROL

When pressed, the top button on the left of the screen will activate the jets when in the home screen. If left running, the pump will automatically turn off after 2 hours.

HYDROMASSAGE JETS

Turn the hydromassage jet pump On to activate all of the hydromassage jets in the seated area as well as the waterfall if the waterfall valve is open.

Press  jet button to activate the hydromassage jets, you will see the jet 1 icon on the screen rotate.

Press  jet button a second time to shut the hydromassage jets off.



LIGHT CONTROL

All fitness systems are equipped with a lighting system. This system includes interior points of lights located throughout the fitness system, as well as exterior lights around the fitness system.

Press the  (middle right) button (when in the home screen) to activate the exterior lights and center light icon. Press a second time to turn exterior lights and center icon light off.

Press the  (lower right) button (when in the home screen) to activate all interior lights and right light icon.

Press a second time to shut all interior lights and right icon light off, when turning back on after several seconds the same light mode will appear.

Every time the light is turned off and on quickly a new light mode will appear.

The sequence is as follows: White, Aqua, Magenta, Azure, Amber, Emerald, Ruby, color wheel with abrupt color changes, slow full color wheel and fast full color wheel.

NOTE: If left on, the lights will automatically turn off after 4 hours of operation.



PURGE TIME

When your fitness system is first powered up, the default purge time is set to start at 12:00 pm unless you set the time using the control panel (see Date & Time under Settings). Because the fitness system uses a 24 hour circulation pump filter cycle settings are not available, however, the hydromassage jet pump will purge for 1 minute at any of the purge time setting start times.

We recommend setting your date and time first, then going to the Water Care / Heater Settings section and making any desired changes for days, start times and length of time in the desired Water Care Mode.

NOTE: Power interruption of the fitness system will not change the filter cycle settings when power is regained.

PURGE CYCLE SUSPENSION:

The purge cycle will be suspended every time a jet pump or light is activated manually during the purge cycle time. The suspension will end 10 minutes after the completion of the manual use.

ALL OFF / MEMORY ON

Press the  (top right) button when in the home screen to turn the lights and any jets that are on OFF. It will not turn the music system off.

If you press this button again before pressing the light or jets button it will bring up the last settings before shutting off.

NOTE: The color of the lights will however advance to the next sequence.



WI-FI IN.TOUCH 2 (OPTIONAL)

If your fitness system is equipped with the Wi-Fi in.touch 2 module you will be able to use the internet or your home Wi-Fi network to control your fitness system by downloading an App to your favorite devices.

See Wi-Fi in the Settings section to connect your fitness system to your home Wi-Fi network.

For instruction on how to download the App to your device search "gecko in.touch 2" in your App store. For more instructions go online to the in.touch setup guide:

http://www.geckoalliance.com/Documents/intouch_setupguide_d_en.pdf

SMART WINTER MODE





The Smart Winter Mode (SWM) is used to prevent water from freezing in the plumbing lines. As soon as there is a risk of freezing, this protection automatically kicks in. The SWM protection will turn back off only after 24 hours without a risk of freezing. During the SWM period, the Smart Winter Mode icon remains on; the icon blinks when the purge is active. The purge period indicates the amount of time between the purging of the plumbing lines based on the temperature behind the panels.



AUXILIARY CONTROL PANEL



On the opposite side of the main control panel inside the fitness system you will find the auxiliary panel which allows the user to activate the hydromassage jets, lights and all off/memory on functions (not available on the E550 model).

- Press  jet button to activate the hydromassage jets. Press  jet button a second time to shut the hydromassage jets off.
- Press the  button to activate the exterior lights. Press a second time to turn exterior lights off.
- Press the  button to activate all interior lights. Press a second time to shut all interior lights off.
- Press the  button to turn the lights and any jets that are on OFF. If you press this button again before pressing the light or jets button it will bring up the last settings before shutting off.

NOTE: The color of the lights will however advance to the next sequence.

WATER QUALITY AND MAINTENANCE

BASIC INFORMATION

It's important to have clean water. Water maintenance is one of the least understood, yet most important areas of fitness system ownership. Your dealer can guide you through the process of achieving and maintaining balanced water in your fitness system, given your local conditions.

IMPORTANT: Water Terminology can be found at the end of this section.

- **Always read & refer to the owner's manual** for complete information.
- **Test your water** with a test strip once a week, or each time the fitness system is used.
- **Add chemicals** in frequent, small amounts to prevent overdosing the fitness system.
- **Use the fitness system only** when the chlorine level is between 1-5 ppm or manually add chlorine as needed.
- **It is the fitness system owner's responsibility** to prevent over or under chlorination.

IMPORTANT: It is recommended at a minimum to change 50% of your water every year; however, it is dependent on the amount of usage. Check with your **ENDLESS POOLS** dealer to determine if water in your region has unique qualities - such as high metal or mineral content - that should be addressed.

WATER QUALITY CHART

PARAMETER	TARGET	MIN - "OK" RANGE - MAX	
pH	7.4	7.2	7.8
ALKALINITY	100 ppm	80 ppm	120 ppm
HARDNESS	100 ppm	75 ppm	150 ppm
CHLORINE	3 ppm	1 ppm	5 ppm

Maintaining the water quality and the cleanliness of the filters in your fitness system is your responsibility. Keeping the fitness system water balanced prolongs the life of the components and will make the water more comfortable. Your program will depend on your water's mineral content, how often you use your fitness system, and how many people use it. Watkins Wellness has developed several water care systems and products to simplify water care which are available from authorized **ENDLESS POOLS** dealers.

CHEMICAL SAFETY

When using chemicals, read the labels carefully and follow directions precisely. Though chemicals protect you and your fitness system when used correctly, they can be hazardous in concentrated form. Always observe the following guidelines:

- Allow only a responsible person to handle fitness system chemicals. Keep them out of the reach of children.
- Accurately measure the exact quantities specified, never more. Do not overdose your fitness system.
- Handle all containers with care. Store in a cool, dry, well ventilated place.
- Always keep chemical containers closed when not in use. Replace caps on their proper containers.

- Don't inhale fumes, or allow chemicals to come in contact with your eyes, nose, or mouth. Wash your hands immediately after use.
- Follow the emergency advice on the product label in case of accidental contact, or if the chemical is swallowed. Call a doctor or the local Poison Control Center. If a doctor is needed, take the product container along with you so that the substance can be identified.
- Don't let chemicals get on surrounding surfaces or landscaping. Don't use a vacuum cleaner to clean up chemical spills.
- Never smoke around chemicals. Some fumes can be highly flammable.
- Don't store any chemicals in the fitness system equipment compartment.

HOW TO ADD CHEMICALS TO THE WATER

IMPORTANT: All fitness system water chemicals, must always be dispersed into the swim area while the swim machine is running higher than 50%, and must run for a minimum of ten minutes.

TO ADMINISTER FITNESS SYSTEM WATER CHEMICALS:

1. Fold back the cover.
2. Turn swim machine ON, run for 10 minutes and turn OFF.
3. Carefully measure the recommended amount of chemical and disperse into swim area while swim machine is on. Use care not to splash chemicals on your hands, in your eyes, on the fitness system sheet surface, or on the siding.
Risk of Drowning: Never leave an open fitness system unattended!

⚠ WARNING: High sanitizer levels can cause discomfort to the user's eyes, lungs and skin. Always allow the sanitizer level to fall to the recommended range before using the fitness system.

IMPORTANT "SUPER CHLORINATION/NON-CHLORINE SHOCK TREATMENT" NOTE: After administering a super chlorination treatment or non-chlorine shock to your fitness system, leave the cover open for a minimum of 20 minutes to allow the oxidizer gas to vent. A high concentration of trapped oxidizer gas which may exist as a result of the shock treatment (not daily sanitation) may eventually cause discoloration or vinyl degradation to the bottom of the cover.

FUNDAMENTALS OF WATER MAINTENANCE

- **Testing:** Test the water weekly or each time the fitness system is used with convenient test strips or more accurate liquid/tablet reagent test kit per instructions. Critical parameters: sanitizer level, pH, Calcium Hardness (CH), and Total Alkalinity (TA). Store test equipment in a dark, cool, dry place to maintain potency.

- **Chemical Balance/pH Control:** It is important to adjust the primary water parameters (Total Alkalinity, Calcium hardness, pH) into the recommended ranges so that they are stabilized or balanced. Balance the water chemistry every time you fill the fitness system with new water and then during the life of that body of water. Keeping the water

ALKALINE WATER (SCALING ZONE)	8.2	ADD pH DECREASER TO LOWER pH
	7.8	
COMFORT ZONE	7.6	IDEAL
	7.4	
	7.2	
ACIDIC WATER (CORROSIVE ZONE)	6.8	ADD pH INCREASER TO RAISE pH
	pH	

in balance prevents damage by holding the pH in a safe range and preventing calcium scale formation on fitness system equipment. A low pH can damage metal components whereas a high pH can cause high levels of calcium to form scale. Your dealer should provide a detailed water chemistry orientation soon after your new fitness system is filled for the very first time.

- The following three water components must be kept in balance to avoid damage to the fitness system. Do balance these components in the order they are listed here as each will help you balance the next using a minimum amount of chemicals.
 1. Calcium Hardness (CH) – CH is the measure of the amount of dissolved calcium in the water. Low levels can make the water corrosive and high levels cause scale formation on fitness system components. The recommended CH reading is between **75 - 150 ppm**. If the CH level is too high, lower it with the calcium remover per instructions. Once in balance, the CH reading normally remains stable until more water is added. Great care must be taken when filling the fitness system from a water softener to ensure that the calcium remains in balance and avoid damage to the fitness system.
 2. Total Alkalinity (TA) - TA is a measure of the water's ability to resist changes of pH or buffer capacity. A low TA allows the pH to fluctuate easily. The recommended TA reading is between **80 - 120 ppm**. To raise the TA, use pH/Alkalinity Up (sodium hydrogen carbonate). To lower the TA, use pH/Alkalinity Down (sodium bisulfate). We recommend you check the TA reading once per month. Raising/lowering the TA may cause the pH readings to fluctuate widely. Ignore the pH readings on the test strip while you are balancing the TA.
 3. pH - The pH is the measure of the acidity and alkalinity. Maintaining the proper pH level will optimize the effectiveness of the sanitizer, preventing damage to the fitness system and physical discomfort for fitness system users. A low pH dissipates sanitizer, causes corrosion, and irritates fitness system users. A high pH level will neutralize sanitizer, promote scaling and cloud water. The recommended pH reading is between **7.2 - 7.8**. To lower the pH level, use pH/Alkalinity Down (sodium bisulfate). To raise the pH level, use pH/Alkalinity Up (sodium carbonate).
- **Water Conditioners:** Fitness system fill water varies from location to location and user to user, therefore it is important to consult with your dealer for an appropriate program.
 - a. The **CLEAN SCREEN** pre-filter should be used at every fill and top-off to remove contaminants from the fill water, especially iron, copper, and manganese. Many water sources, including well water, contain high concentrations of minerals that can cause staining of the shell and plastics.
 - b. Stain and Scale control – For water high in calcium and minerals, it may be necessary to use an anti-scalant like Stain and Scale control. As water evaporates from your fitness system and new water is added, the amount of dissolved minerals like calcium, copper, iron, and manganese will increase. (Minimize evaporation by keeping the cover on the fitness system whenever possible.) High iron or copper content in the water may produce green or brown stains on the fitness system.
 - c. Foam Inhibitors - Soap is introduced into the fitness system water from users' bodies and swimming apparel and can cause the fitness system water to foam when the jets are used. Low levels of calcium hardness (soft water) can increase foaming. Although ozone can oxidize soap residual, it may become necessary to add Foam Inhibitors to suppress the foam. Excessive soap in the water may require a water change to resolve.

- **Oxidizers:** Ozone and Monopersulfate (MPS) are oxidizers used to prevent the buildup of contaminants, maximize sanitizer efficiency, minimize combined chlorine, and improve water clarity. They are to be used in conjunction with EPA registered sanitizers. The UV-C Ozone system combines the Corona Discharge generator and a UV-C lamp. The UV-C lamp kills and damages bacteria DNA on contact providing a maximum water sanitation solution. Chlorine-Free Oxidizer, Monopersulfate (MPS) is a granular oxidizing chemical.
- **Sanitizers:** Maintaining the recommended residual level of an EPA registered sanitizer at all times will decrease the occurrence of unsafe bacteria and viruses in your fitness system water. The recommended Free Available Chlorine (FAC), the amount of available chlorine sanitizer, is **1.0-5.0 ppm**. A low FAC can allow bacteria and viruses to grow rapidly in the warm water, and a high FAC can cause discomfort to the user's eyes, lungs, and skin. Each sanitizer carries its own instructions regarding how much to use and when to add it to the fitness system water. Consult your dealer for their recommendations and instructions on proper sanitizing of the fitness system.

Watkins Wellness recommends the following sanitizer:

- Sodium Dichloro-s-Triazinetrione (sodium dichlor or chlorine)
- Biguanide
- Liquid sodium hypochlorite

WARNING: DO NOT use tri-chlor chlorine, bromo-chloro-dimethyl-hydantoin (BCDMH), or any type of compressed bromine or chlorine, acid or any type of sanitizer which is not recommended by Watkins Wellness.

THE ENDLESS POOLS WATER MAINTENANCE PROGRAM

FILLING THE FITNESS SYSTEM WITH WATER

Use the **CLEAN SCREEN** pre-filter to remove unwanted contaminants such as rust, dirt, detergents, and algae from the fill water. Dissolved metals, copper, iron, and manganese are also removed. Instructions are included with the **CLEAN SCREEN** pre-filter. Always fill the fitness system through the filter compartment. Do not fill your fitness system using water from a swimming pool as pool chemicals are very different from those used in a fitness system and can damage your fitness system.

ADDING CHEMICALS TO THE WATER

All fitness system water chemicals must always be dispersed directly into the swim area while swim machine is running over 50% and it must run for a minimum of ten minutes with the covers off.

BUILDING A SANITIZER ROUTINE

During the first month of ownership, measure the sanitizer residual daily, in order to establish a baseline of sanitizer needed vs. fitness system usage. Sanitizer needed is the amount of Free Available Chlorine needed to accommodate the number of users and their combined usage time. For example, two fitness system users for twenty minutes every day creates regular demand on the sanitizer that is used to determine how much sanitizer to add in order to maintain the proper residual. If the usage pattern increases dramatically with invited guests, the amount and frequency of sanitizer required will also increase.

PERFORMING SUPER CHLORINATION/ NON-CHLORINE SHOCK TREATMENT

A weekly or monthly super chlorination (1.5 tsp dichlor/250 gal) or shock (4tbs mps/250 gal) may be required of your chosen sanitation program. Increasing chlorine to 5 ppm for 24-48 hours removes excess waste and chloramines from the water. Sodium dichlor is 6x stronger than MPS and may be more appropriate for those users that experience heavy bather load conditions. Operate swim machine and leave the cover open for a minimum of 20 minutes to allow the oxidizer gas to vent to prevent damage and discoloration to the cover and pillows after administering a super chlorination or shock to your fitness system. This type of damage is considered chemical abuse and is not covered under the terms of the limited warranty.

IMPORTANT: Always allow the Free Available Chlorine to fall below 5 ppm before using your fitness system.

⚠ DANGER: Never leave an open fitness system unattended, especially if there are children present!

USING SILVER ION

Silver ions are introduced into the water via erosion of silver infused beads which inhibits bacteria growth. When combined with MPS, or chlorine, waste is oxidized and removed from the water. It is important to follow the recommended application and maintenance programs outlined for the product's use. If the fitness system is being used over an extended period of time, such as a whole afternoon or evening, additional sanitizer will be needed. Required:

- One Silver Ion cartridge per 500 gallons (1,893 liters).
- Silver Ion cartridges to be placed inside filter skimmer tray (maximum of 2 per tray).
- Weekly Super Chlorinate/Shock the fitness system to reactivate the silver ion cartridge, allow the release of silver ions, and quickly destroy any remaining contaminants. Without this weekly shock treatment, the silver ion cartridge may stop releasing silver ions into the water.

IMPORTANT: Use only Dichlor sanitizer. Silver is not compatible with bromine and biguanides. Don't use a water clarifier. Clarifiers will cause the water to become cloudy.

MANUAL CHLORINE (SODIUM DICHLOR)

Watkins Wellness recommends the use of Concentrated Chlorinating Granules (sodium dichlor) for sanitizing the water. Sodium dichlor is preferred because it is totally soluble, dissolves quickly, and is nearly pH neutral. The recommended Free Available Chlorine (FAC), the amount of available chlorine to sanitize the fitness system, 1.0-5.0 ppm.

If the FAC is too low: Increase the FAC by adding granulated sodium dichlor.

If the FAC is too high: Allow time to pass and the FAC level will naturally drop over time.

If the fitness system smells of chlorine: super chlorinate or shock the fitness system FAC chlorine does not have an odor whereas combined spent chlorine (chloramines) has a strong chlorine odor that can be eliminated by shocking the water.

IMPORTANT: There are several forms of stabilized chlorine available for use in fitness systems and swimming pools. It is extremely important to choose one specifically designed for fitness systems. Use of an incorrect product such as tri-chlor which has a very low pH (2.6) and dissolves too quickly in hot water, results in extremely high levels of chlorine that **WILL** cause damage to your fitness system. Use of a

liquid or compressed bromine/chlorine or unapproved sanitizer **WILL** damage your fitness system and is specifically not covered under the terms of the limited warranty.

OZONE PLUS UV-C MAINTENANCE

If the water in your fitness system lacks the clarity you're used to, you find your chemicals increasingly out of balance and your water simply will not be sanitized like it should be then you should ask your technician to test your Ozone Generator and check you UV-C lamp which may need to be replaced.

⚠ DANGER: Corrosive condensation may collect in dips or loops in the tubing. DO NOT DRAIN IT. Have an Ozone Technician remove the acidic liquid.

Water chemistry damage is not covered by the warranty. The chemical levels and water quality in the fitness system are under your direct control. With proper basic care, the fitness system will provide many years of water relaxation. If you are unsure about any chemical or its usage in the fitness system, contact your Authorized Dealer, or Watkins Wellness.

DO:

- Disperse all chemicals slowly into the swim area with the swim machine operating over 50% for ten minutes.
- Use special care if using baking soda to clean either the interior or exterior plastic surfaces.

IMPORTANT: Watkins Wellness DOES NOT recommend the use of any floating chemical dispenser. Damage to the fitness system shell or components caused by a floating chemical dispenser is specifically not covered under the terms of the limited warranty. Floating dispensers can become trapped in one area and cause an over-sanitization or release large chunks of sanitizer that very quickly chemically burn the shell and cover.

DON'T:

- Use compressed sanitizers.
- Use a floater type sanitization system as a low or no maintenance solution to your fitness system maintenance program.
- Use a sanitizer which is not designed for fitness systems.
- Broadcast or sprinkle the chemicals onto the water surface without the swim machine running during chemical additions and any additional 10 minutes after dose. This method may cause chemically-induced fitness system surface blistering (chemical abuse).

VACATION WATER CARE INSTRUCTIONS

If you plan to be away from home, follow these instructions to ensure that the water quality of your fitness system is maintained:

SHORT TIME PERIODS (3-5 DAYS):

- Adjust the pH by following the instructions outlined in the Water Quality and Maintenance section.
- Sanitize the water by following the shock procedures also listed in the Water Quality and Maintenance section.
- Lock your cover in place using the coverlocks.
- Set Water Care Mode to Away from Home (pg.12).
- Upon your return, sanitize the water by following the shock procedures, and balance the pH.

LONG TIME PERIODS (5-14 DAYS):

Prior to leaving:

1. At least one day before you leave, set Water Care Mode to Away.
IMPORTANT: Fitness system water oxidizers such as sodium dichlor (chlorine) maintain their level of effectiveness substantially longer in cool water 59°F (15°C) than in hot water 97°F to 99°F (36°C - 37.5°C).
2. Adjust the pH as required. Sanitize the water by following the shock procedures.

Upon your return:

3. Sanitize the water by following the shock procedures. Return the set temperature to its original setting. The fitness system water will be safe for you to use once the Free Available Chlorine residual level has dropped below 5.0 ppm.
IMPORTANT: If you will not be using your fitness system for an extended period of time (in excess of 14 days) and an outside maintenance service (or neighbor) is not available to assist with the water maintenance, draining or winterizing of the fitness system is recommended.

SUPPLEMENTAL WATER MAINTENANCE

Proper water sanitation and mineral balance (pH control) are absolutely essential for a complete fitness system water maintenance program. Here are two other popular water additives that are optional:

Mineral Deposit Inhibitors

As water evaporates from your fitness system and new water is added, the amount of dissolved minerals will increase. (Minimize evaporation by keeping the cover on the fitness system whenever possible.) The fitness system water may eventually become "hard" (Calcium Hardness too high) enough to damage the heater by calcifying its surface. Proper pH control can minimize this.

Occasionally, high iron or copper content in the water may produce green or brown stains on the fitness system. A stain and scale inhibitor may help to reduce these metals.

IMPORTANT: Well water may contain high concentrations of minerals. The use of a low water volume, extra-fine pore water filter (in-line pre-filter such as the **CLEAN SCREEN** pre-filter) will help to remove many of the larger particles during the filling of the fitness system. In-line pre-filters can be purchased at your local **ENDLESS POOLS** dealer.

Foam Inhibitors

Fitness system water requires changing due to the buildup of soap in the water. Typically, soap will cause the fitness system water to foam when the jets are used. Soap is introduced into the fitness system water from two sources: users' bodies, which retain a soap residual after showering, and swimming apparel, which retains soap after washing.

Foam inhibitors can suppress foam, but cannot remove soap from the water. Soap is very difficult to remove from the water because soap is not oxidized by any chemical added to the fitness system. Only ozone can oxidize soap. Eventually the soap build-up in the water will be concentrated, resulting in an unclean feeling on the bather's skin, which is impossible to remedy. When this occurs, it's time to drain and refill the fitness system.

GLOSSARY

The following chemical terms are used in this Water Quality and Maintenance section. Understanding their meaning will help you to better understand the water maintenance process.

Bromamines: Compounds formed when bromine combines with nitrogen from body oils, urine, perspiration, etc. Unlike chloramines,

bromamines have no pungent odor, and are effective sanitizers.

Bromine: A halogen sanitizer (in the same chemical family as chlorine). Bromine is commonly used in stick, tablet, or granular form however, stick and tablet form should NOT be used.

Calcium Hardness: The amount of dissolved calcium in the fitness system water. This should be approximately 75 -150 ppm. High levels of calcium can cause cloudy water and scaling. Low levels can cause harm to the fitness system equipment.

Chloramines: Compounds formed when chlorine combines with nitrogen from body oils, urine, perspiration, etc. Chloramines can cause eye irritation as well as having a strong odor. Unlike bromamines, chloramines are weaker, slower sanitizers.

Chlorine: An efficient sanitizing chemical for fitness systems. Watkins Wellness recommends the use of sodium dichlor-type granulated chlorine. This type is preferred because it is totally soluble and nearly pH neutral.

Chlorine (or Bromine) Residual: The amount of chlorine or bromine remaining after chlorine or bromine demand has been satisfied. The residual is, therefore, the amount of sanitizer which is chemically available to kill bacteria, viruses and algae.

Corrosion: The gradual wearing away of metal and plastic fitness system parts, usually caused by chemical action. Generally, corrosion is caused by low pH or by water with levels of TA, CH, pH or sanitizer which are outside the recommended ranges.

Halogen: Any one of these five elements: fluorine, chlorine, bromine, iodine, and astatine.

MPS: Monopersulfate is a non-chlorine oxidizer.

Nitric Acid: The formulation of nitric acid, a highly corrosive chemical, is a byproduct of the ozone generating process. Nitric acid is produced in very small quantities and is readily dissolved in the water stream with ozone.

Oxidizer: The use of an oxidizing chemical is to prevent the buildup of contaminants, maximize sanitizer efficiency, minimize combined chlorine and improve water clarity. See MPS and Ozone.

Ozone: Ozone is a powerful oxidizing agent which is produced in nature and artificially by man. Ozone forms no byproducts, oxidizes chloramines, and will not alter the water's pH.

pH: The measure of the fitness system water's acidity and alkalinity.

ppm: The abbreviation of "parts per million", the standard measurement of chemical concentration in water. Identical to mg/l (milligrams per liter).

Reagent: A chemical material in liquid, powder, or tablet form for use in chemical testing.

Sanitizer: Sanitizers are added and maintained at recommended residuals to protect bathers against pathogenic organisms which can cause disease and infection in fitness system water.

Scale: Rough calcium-bearing deposits that can coat fitness system surfaces, heaters, plumbing lines, and clog filters. Generally, scaling is caused by mineral content combined with high pH. Additionally, scale forms more readily at higher water temperatures.

Super-Chlorination: Also known as "shock treatment." Super-Chlorination is a process of adding significant doses of a quick dissolving sanitizer ("dichlor" is recommended) to oxidize non-filterable organic waste and to remove chloramines and bromamines.

Total Alkalinity (TA): The amount of bicarbonates, carbonates, and hydroxides present in fitness system water. Proper total alkalinity is important for pH control. If the TA is too high, the pH is difficult to adjust. If the TA is too low, the pH will be difficult to hold at the proper level. The desired range of TA in fitness system water is 80 to 120 ppm.

CARE AND MAINTENANCE

Your **ENDLESS POOLS** fitness system is manufactured from the highest quality, most durable materials available. Even so, the fitness system care and maintenance program you develop will ultimately determine how long your fitness system, and its individual components, will last. Regular maintenance and following the advice in this section will help you to protect your investment.

FILTER MAINTENANCE

At least once a week, check and clean the skimmer trays to ensure proper filter flow. Remove leaves, foreign matter, and debris. It is very important to keep your fitness system filter cartridges clean and free of particles to ensure proper water flow. Clean filters enables the hydrotherapy system to function properly and allows for more efficient filter cycles. Depending on how frequently your fitness system is used, we recommend cleaning the fitness system filter cartridges every four weeks. If this is not done, the filter may clog and restrict water flow, which causes improper filtration, poor jet performance and may possibly freeze.

IMPORTANT: The frequency and duration of use, and the number of occupants all contribute to determining the appropriate time between filter cleanings. More use means that more frequent filter cleanings will be required.

FILTER CARTRIDGE REMOVAL AND CLEANING INSTRUCTIONS

Place the fitness system in the "Standby" mode, then proceed as follows:

1. Find the filter grate inside the fitness system.



2. Pull the filter grate from the bottom up until it unlocks from the wall.

IMPORTANT: ONLY PULL FILTER GRATE UP SLIGHTLY.



3. Pull filter grate away from wall and set aside.



4. Pull skimmer tray away from wall, remove and clean.



5. To remove the filter, turn using the handle in the center of the filter counter-clockwise.



6. Pull filter up, then angle the top away from the filter compartment to pull filter completely out. Each filter has 50 sq. feet of effective filter area.



7. Repeat steps 4 & 5 to remove second filter.

Always clean the filter using a filter degreaser to remove mineral and oil build-up. Simply soak the filter in the degreaser (according to the package directions), then place the filter on a clean surface and spray until clean using a garden hose. It may be necessary to rotate the filter while spraying to remove any debris lodged between the filter pleats.



8. Re-insert filter cartridge by reversing steps 5, 6 & 7.
9. Slide skimmer tray back into filter compartment reversing step 4.
10. Position filter grate as seen in step 2 & 3, grate should touch wall of fitness system slightly above black filter equipment compartment tracks. Slide filter grate down until it stops.

Repeat all of the above steps for the filters on the opposite side

NOTE: Replacement filter cartridges are available from your **ENDLESS POOLS** dealer. Refer to the back of this manual to determine the appropriate size for your fitness system.

DRAINING YOUR FITNESS SYSTEM

1. Turn off all GFCI breakers in sub-panel, or main electrical panel.

Locate the drain valve for the fitness system.

Pull on handle (Figure 1, pliers may be used to pull handle) until you reach the mid position then rotate handle slightly to fully extended drain tube (drain cap and 1" (2.5 cm) of the drain tube is exposed) (Figure 2) then remove the drain cap (Figure 3).

NOTE: Do not remove drain cap in mid position. Attach the garden hose to the end of the drain (to avoid flooding of the foundation surrounding the fitness system) making sure not to push the drain tube inward. Route the outlet of the hose to an appropriate draining area.

NOTE: Fitness system water with a high sanitizer level may harm plants and grass.

2. Push the garden hose and drain tube half-way back towards the fitness system (Figure 4) which will start the gravitational flow. Drain tube must be in the mid position for the fitness system to drain.

IMPORTANT: All models will drain almost completely through the drain valve. Equipment such as the jet pump and heating system may not completely drain. Any water remaining within the plumbing or equipment after draining will only need to be removed if the fitness system is being winterized.

3. After your fitness system is empty, clean the shell and filter cartridges.
4. Pull and remove garden hose, replace drain cap and push drain tube back into fitness system as seen in Figure 1.
5. Follow the "START-UP PROCEDURES" to refill your fitness system.

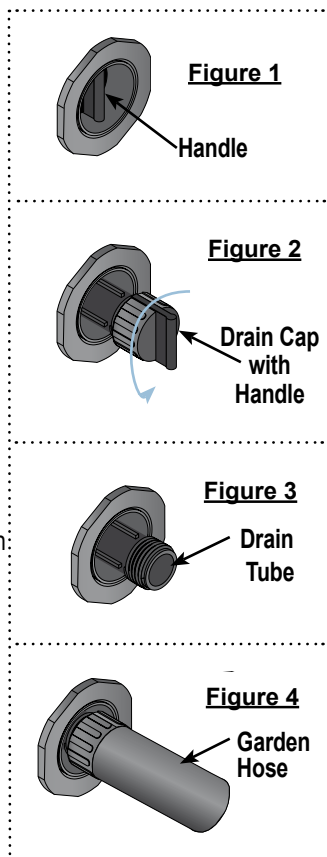

WINTERIZING YOUR FITNESS SYSTEM

An **ENDLESS POOLS** fitness system may be used year round, even in colder climates. If you will not be using the fitness system during the winter in an area where freezing is a problem, special consideration must be taken to protect the fitness system and auxiliary equipment if either is located outside. If you have any questions regarding precautions to take against freezing, please call your **ENDLESS POOLS** Dealer.

CARE OF THE PILLOWS (E500 & E700)

The fitness system pillows will provide years of comfort if treated with care. They have been positioned above the water level to minimize the bleaching effects of chlorinated water and other fitness system water chemicals. To extend their life, whenever the fitness system shell is being cleaned, the fitness system pillows should be removed and cleaned. Body oils can be removed with a mild soap and water solution. ALWAYS rinse off the fitness system pillows thoroughly to remove any soap residue. If the fitness system is not going to be used for a long period of time (that is during a vacation or if the fitness system is winterized), or when the fitness system water is being super-chlorinated, the fitness system pillows should be removed until the next use of the fitness system.

TO REMOVE AND REPLACE THE PILLOWS:

1. Carefully lift one end of the pillow away from the fitness system shell.
2. Continue lifting one end until all pillow retainers are released from the pillow.

IMPORTANT: Just pulling the pillow straight up and out of the shell recess will eventually damage the pillow. This abuse is not covered under warranty.

3. To reinstall the fitness system pillow, carefully bend the pillow slightly to allow one of the pillow retainers to slip into the recess in the back of the pillow.
4. Keeping the pillow slightly bent, slide the other pillow retainer into the recess in the back of the pillow.
5. After all the pillow retainers are in place, press the pillow down into the recess in the fitness system shell.

CARE OF THE EXTERIOR

FITNESS SYSTEM SHELL

Your **ENDLESS POOLS** fitness system has an acrylic shell. Stains and dirt generally will not adhere to your fitness system's surface. A soft rag or a nylon scrubber should easily remove most dirt. Most household chemicals are harmful to your fitness system's shell (see below for detailed information on cleaning agents). Always rinse off any fitness system shell cleaning agent with fresh water.

IMPORTANT:

1. The following products are the **ONLY** approved cleaning agents for your **ENDLESS POOLS** fitness system shell: plain water, Spa Shine, Brillianize[®] or Soft Scrub[®]. The use of alcohol or any other household cleaner other than those listed to clean the fitness system shell surface is **NOT** recommended. **DO NOT** use any cleaning products containing abrasives or solvents since they may damage the shell surface, specifically: Simple Green[®], Windex[®] or Spa Mitt. **NEVER USE HARSH CHEMICALS!** Damage to the shell by use of harsh chemicals is not covered under the warranty. Always rinse off any fitness system shell cleaning agent with fresh water.
2. Iron and copper in the water can stain the fitness system shell if allowed to go unchecked. Ask your **ENDLESS POOLS** dealer about a Stain and Scale Inhibitor to use if your fitness system has a high concentration of dissolved minerals. (Watkins Wellness recommends Stain & Scale Defense.)
3. Keep all cleaners out of the reach of children and use care when applying.

FITNESS SYSTEM CABINET

All fitness systems use the exclusive all-weather cabinet designed for years of performance. The unique design is made from a rigid polymer for durability and adds a film finish that provides a rich appearance.

Cleaning consists of simply spraying the cabinet with a mild soap and water solution to remove any stains and residue.

Do not rub the cabinet with an abrasive material or use abrasive cleaners as this may damage its surface.

VINYL COVER (OPTIONAL)

The vinyl cover is an attractive, durable foam insulation product. Monthly cleaning and conditioning are recommended to maintain its beauty.

To clean and condition the vinyl cover without a lifter:

1. Remove the covers from the fitness system and gently lean against a wall or fence.
2. With a garden hose, spray the covers to loosen and rinse away dirt or debris.
3. Using a large sponge and/or a soft bristle brush, and using a very mild soap solution (one teaspoon dishwashing liquid with two gallons of water), or baking soda (sodium bicarbonate), scrub the vinyl top in a circular motion. Do not let the vinyl dry with a soap film on it before it can be rinsed clean.
4. Scrub the cover's perimeter and side flaps. Rinse clean with water.
5. Rinse off the underside of the cover with water only (use no soap), and wipe it clean with a dry rag.

IMPORTANT: To remove tree sap, use cigarette lighter fluid (not charcoal lighter fluid). Use sparingly, and rinse with a saddle soap solution immediately afterwards, then wipe dry.

HYDRAULIC TANK OIL REPLACEMENT

It is recommended to replace the non-food grade, biodegradable vegetable oil and filter used on both the swim machine or optional tandem treadmill hydraulic unit after 500 hours of use. Contact your **ENDLESS POOLS** dealer to perform this maintenance.

SERVICE INFORMATION

GENERAL INFORMATION

Your **ENDLESS POOLS** fitness system has been designed to provide years of trouble-free use. As with any appliance, problems may occasionally occur that require the expertise of a qualified service person. Though such simple repairs as resetting a GFCI switch or breaker, or resetting a high limit thermostat may not require a service call, they may indicate that a more serious condition exists. These conditions may require an experienced service person. Before calling for service, please refer to the Troubleshooting Guide. Always retain your original sales receipt for future reference.

GFCI AND HIGH LIMIT THERMOSTAT

If your fitness system fails to operate at any time, first check the power supply to the fitness system.

Check each of the GFCI breakers in the subpanel. If a GFCI has tripped, reset it. If it will not reset, this may be an indication of a ground fault (short circuit) within the electrical components. Contact an Authorized Service Technician for a complete diagnosis.

If upon checking the GFCI's you find that they have not tripped, check the house breaker panel and ensure the main breaker for the electrical circuit supplying the fitness system has not tripped. If it has, this is an indication that the circuit was either overloaded or a ground fault exists between the breaker panel and the fitness system receptacle or subpanel. Contact a qualified electrician.

If upon checking the main house breaker and fitness system GFCI's you find no failures, check the high limit thermostat. To check it, simply turn off power to the fitness system for 30 seconds. This will automatically reset the high limit thermostat if it has tripped. If the fitness system energizes once you turn the power back on, this indicates reduced water flow through the heating system. Tripping of the high limit thermostat is normally a result of one or a combination of these problems. 1) clogged filter cartridge(s), 2) blockage within the system plumbing, 3) a non-functioning heater circulation pump, 4) power was not disconnected from the fitness system before it was drained, 5) an air lock in the plumbing lines. (The Power Indicator on the front of the fitness system's control panel will also be blinking if the high limit thermostat circuit has tripped.)

If the fitness system does not function after tripping and resetting the GFCI's or resetting the high limit thermostat, then the problem should be referred to an Authorized Service Technician. Refer to the Troubleshooting Guide for additional service information.

MISCELLANEOUS SERVICE INFORMATION

The control and high-limit thermostats are equipped with electronic sensors that are connected to the fitness system's plumbing. Never cut or kink the wires that connect the sensors to the thermostats within the control box.

The jet pump is equipped with a thermal overload cutoff switch that is designed to protect the pump from overheating. If the pump shuts itself off in an older fitness system, it could indicate failure of the pump motor bearings. If the pump shuts itself off in a new fitness system, it is usually the result of one or a combination of the following factors:

- Thermal overload: Although mass-produced, not all thermal overload cutoffs are exactly the same. Some are more sensitive than others and will shut the pump off at lower temperatures.

- High temperature: All **ENDLESS POOLS** fitness system models are equipped with a jet pump shroud that vents the heat generated by the pump motor to the outside of the equipment compartment, and back into the fitness system water. If the vent is blocked by masonry, grass or debris, overheating of the jet pump may occur. Once the pump motor has cooled sufficiently and any blockage has been removed from the vent opening, the jet pump can be restarted.
- Friction: Sometimes the moving parts of a new pump are tight enough to cause heat build-up due to friction. After a normal break-in period, the pump will run cooler.
- Improper wiring: If the fitness system is connected with an extension cord, and/or the house wiring is undersized, the pump may starve for voltage and therefore may draw more amperage and generate excessive heat.
- If the pump is shutting down due to excessive heat, make sure the equipment compartment has adequate ventilation. The air gap at the bottom must not be blocked. Should your jet pump continue to shut off after short periods of use, contact a qualified service technician.

ACTS INVALIDATING WARRANTY

The limited warranty is void if the **ENDLESS POOLS** fitness system has been improperly installed, subjected to alteration, misuse, or abuse, or if any repairs on the fitness system are attempted by anyone other than an authorized representative of Watkins Wellness. Alteration shall include any component or plumbing change, electrical conversion, or the addition of any non-approved sanitation or water purification device or heating system which contributes to component or unit failure or unsafe operating system. Misuse and abuse shall include any operation of the fitness system other than in accordance with Watkins Wellness printed instructions, or use of the fitness system in an application for which it is not designed; specifically: use of the fitness system in a non-residential application; damage caused by operation* of the fitness system at water temperatures outside the range of 35°F and 120°F (2°C and 49°C); damage caused by a dirty, clogged or calcified filter cartridge; damage to the fitness system surface caused by the use of tri-chloro chlorine, BCDMH, misuse of chemical tablets in a floater, acid, or any other fitness system chemicals or fitness system surface cleaners which are not recommended by Watkins Wellness; damage caused by allowing undissolved fitness system sanitizing chemicals to lie on the fitness system surface (no fitness system surface material can withstand this kind of abuse); damage to components or fitness system surface caused by improper water chemistry maintenance; and damage to the fitness system surface caused by leaving the fitness system uncovered while empty of water and in direct exposure to sunlight (this may cause solar heating distress in warm weather regions). These are considered abuses and may invalidate this warranty.

*Operation of the fitness system does not mean "use" of the fitness system! Watkins Wellness does not recommend using the fitness system if the water temperature is above or below the fitness system's control panel temperature range.

DISCLAIMERS

Watkins Wellness shall not be liable for loss of use of the **ENDLESS POOLS** fitness system, or other incidental, consequential, special, indirect, or punitive costs, expenses or damages, which may include but are not limited to the removal of a permanent deck or other custom fixture, or the necessity for crane removal. Any implied warranty shall have a duration equal to the duration of the applicable limited warranty stated above. Some states do not allow limitations on how long an implied warranty lasts. Under no circumstances shall Watkins Wellness or any of its representatives be held liable for injury to any person or damage to any property, however arising.

Some states do not allow the exclusion or limitation of incidental or consequential damages, so the above limitations may not apply to you.

WATKINS WELLNESS CUSTOMER SERVICE

If you have any questions about any aspect of your **ENDLESS POOLS** fitness system set-up, operation or maintenance that have not been answered by this manual, consult your **ENDLESS POOLS** dealer.

Watkins Wellness can be reached at: 800-999-4688 (extension 8432), Monday through Friday, 8 am to 5-pm Pacific Standard Time (PST), or e-mail customerservice@watkinsmfg.com.

TROUBLESHOOTING

Should you experience any problem whatsoever, do not hesitate to contact your authorized **ENDLESS POOLS** dealer. Located below and on the next page are some tips to help you to diagnose and rectify some more common sources of trouble yourself, if you choose to do so.

FITNESS SYSTEM WATER MAINTENANCE TROUBLESHOOTING GUIDE		
Problem	Probable causes	Solutions
Cloudy Water	<ul style="list-style-type: none"> • Dirty filters • Excessive oils / organic matter • Improper sanitization • Suspended particles / organic matter • Overused or old water 	<ul style="list-style-type: none"> • Clean filters • Shock fitness system with sanitizer • Add sanitizer • Adjust pH and/or alkalinity to recommended range • Run jet pump(s) and clean filters • Drain and refill the fitness system
Water Odor	<ul style="list-style-type: none"> • Excessive organics in water • Improper sanitization • Low pH 	<ul style="list-style-type: none"> • Shock fitness system with sanitizer • Add sanitizer • Adjust pH to recommended range
Chlorine Odor	<ul style="list-style-type: none"> • Chloramine level too high • Low pH 	<ul style="list-style-type: none"> • Shock fitness system with sanitizer • Adjust pH to recommended range
Musty Odor	<ul style="list-style-type: none"> • Bacteria or algae growth 	<ul style="list-style-type: none"> • Shock fitness system with sanitizer—if problem is visible or persistent, drain, clean and refill the fitness system
Organic buildup / scum ring around fitness system	<ul style="list-style-type: none"> • Build-up of oils and dirt 	<ul style="list-style-type: none"> • Wipe off scum with clean rag – if severe, drain the fitness system, use a fitness system surface and tile cleaner to remove the scum, and refill
Algae Growth	<ul style="list-style-type: none"> • High pH • Low sanitizer level 	<ul style="list-style-type: none"> • Shock fitness system with sanitizer and adjust pH • Shock fitness system with sanitizer and maintain sanitizer level
Eye Irritation	<ul style="list-style-type: none"> • Low pH • Low sanitizer level 	<ul style="list-style-type: none"> • Adjust pH • Shock fitness system with sanitizer and maintain sanitizer level
Skin Irritation / Rash	<ul style="list-style-type: none"> • Unsanitary water • Free chlorine level above 5 ppm 	<ul style="list-style-type: none"> • Shock fitness system with sanitizer and maintain sanitizer level • Allow free chlorine level to drop below 5 ppm before fitness system use
Stains	<ul style="list-style-type: none"> • Total alkalinity and/or pH too low • High iron or copper in source water 	<ul style="list-style-type: none"> • Adjust total alkalinity and/or pH • Use a metal deposit inhibitor
Scale	<ul style="list-style-type: none"> • High calcium content in water – total alkalinity and pH too high 	<ul style="list-style-type: none"> • Adjust total alkalinity and pH – if scale requires removal, drain the fitness system, scrub off the scale, refill the fitness system and balance the water

GENERAL OPERATION TROUBLESHOOTING GUIDE

Problem	Probable causes	Solutions
Entire fitness system is inoperative	<ul style="list-style-type: none"> Power failure GFCI tripped Heater high-limit thermostat tripped 	<ul style="list-style-type: none"> Check power source Reset GFCI; call for service if it will not reset Disconnect power for at least thirty seconds to reset heater high limit. If it will not reset, check for clogged filters. If tripping continues, call for service.
Fitness system does not heat; jets and light operate	<ul style="list-style-type: none"> Integrated pressure switch open Circulation pump thermal cut-off tripped Water Care Mode 	<ul style="list-style-type: none"> Check for clogged filters. Integrated pressure switch will reset when the flow of water through the heater has been restored. Call for service if the heater trips frequently. Check for clogged filters or air locks in plumbing. Disconnect power to the fitness system, allow circulation pump to cool. Circulation pump thermal cut-off will reset when pump has cooled and power is reapplied. Call for service if circulation pump thermal cut-off trips frequently. Check which Water Care Mode your are in and change if necessary.
Jets weak or surging	<ul style="list-style-type: none"> Fitness system water level too low Filters clogged Water valves are closed 	<ul style="list-style-type: none"> Add water Clean filters Open water valves
Lights inoperative	<ul style="list-style-type: none"> Light wiring or assembly is faulty 	<ul style="list-style-type: none"> Call for service, replace light assembly
Fitness system not heating properly	<ul style="list-style-type: none"> Temperature set too low Fitness system cover improperly positioned Dirty Filter Water Care Mode 	<ul style="list-style-type: none"> Set control panel to a higher temperature. Align fitness system cover Clean filter Check which Water Care Mode your are in and change if necessary.
Pump motor will not function	<ul style="list-style-type: none"> Motor overload condition Control switch failure if jet symbol does not come on 	<ul style="list-style-type: none"> Let cool for one hour. Motor overload will reset automatically. If problem persists, contact your ENDLESS POOLS dealer Disconnect fitness system and contact your ENDLESS POOLS dealer
Noisy pump or motor	<ul style="list-style-type: none"> Low water level 	<ul style="list-style-type: none"> Add water to normal level (6 inch (15.25 cm) below bar top)
Pump motor runs, but low or no water/ jet pressure	<ul style="list-style-type: none"> Air control valve closed Water Valves are closed Dirty filter cartridge Jet blocked Clogged suction or skimmer basket 	<ul style="list-style-type: none"> Open air valve0 Open any closed water valves Clean filter cartridge Remove jet face eyeball and clean orifice Clean suction cover or skimmer basket
After filling or refilling the fitness system: a jet pump is operating, but water is not flowing from any of its jets	<ul style="list-style-type: none"> Pump is not properly primed 	<ul style="list-style-type: none"> Turn off power to the fitness system at the breaker and remove the equipment compartment door. Loosen the union on the top of the pump(s) to allow the air to escape, and then hand-tighten the union(s). Turn power back on, activate the pump, and check to make sure the union is tight enough to keep it from leaking. Replace the equipment doors.
Pump motor runs for 1 minute and shuts off	<ul style="list-style-type: none"> Pump is purging during the start of the Purge time setting 	<ul style="list-style-type: none"> See Water Care/Heater Settings pg. 12 on how to modify schedule
"Heater Suspended" blinking	<ul style="list-style-type: none"> Turning temp down and up while heater is on. 	<ul style="list-style-type: none"> System will automatically cycle and message will go off within 5 minutes.

TROUBLESHOOTING ERROR CODES

Error Code	Cause & Solution
HR	An internal hardware error has been detected . Reset the breaker, if the problem persists, call for service.
HL	The system has shut the heater down because the temperature at the heater has reached 119°F (48°C). Do not enter the water! Remove the cover and allow the water to cool down, then shut power off and power back up again to reset the system.
AOH	Temperature inside the equipment compartment is too high, causing the internal temperature in the control box to increase above normal limits. Shut off power, open equipment compartment and allow area to cool. Close equipment compartment and repower once compartment has cooled down.
FLO	The system does not detect any water flow while the primary pump is running. Check and open water valves. Check for water level. Clean filter. If the problem persists, call for service.
Prr	A problem is detected with the temperature probe. Call for service.
OH	The water temperature in the fitness system has reached 108°F (42°C). Do not enter the water! Remove the cover and allow the water to cool down to a lower temperature. Call for service if problem persists.
UPL	No low-level configuration software has been installed into the system. Call for service.

NOTES:

FITNESS SYSTEM SPECIFICATIONS

This manual contains installation, operating, maintenance, and service information for the following **ENDLESS POOLS** fitness systems:

	Footprint dimensions	Height	Effective filter area	Heater (Watts)	Water capacity	Surface water area	Maximum water depth	Dry weight	Filled weight*	Dead weight	Electrical requirements
E500-58	15'0" x 7'5" 457 cm x 226 cm	58" 147 cm	200 ft ²	4,000	1,770 gallons 6,705 liters	82.5 ft ² 7.7 m ²	46" 117 cm	2,905 lbs 1,320 kg	19,400 lbs 8,800 kg	205 lbs/ft ² 990 kg/m ²	230 volt, 60 amp Single phase GFCI protected circuit
E500-58 Treadmill	15'0" x 7'5" 457 cm x 226 cm	58" 147 cm	200 ft ²	4,000	1,735 gallons 6,570 liters	82.5 ft ² 7.7 m ²	46" 117 cm	3,030 lbs 1,375 kg	19,235 lbs 8,725 kg	205 lbs/ft ² 995 kg/m ²	230 volt, 60 amp Single phase GFCI protected circuit
E550-58	15'0" x 7'10" 457 cm x 239 cm	58" 147 cm	200 ft ²	4,000	2,390 gallons 9,050 liters	88.4 ft ² 8.2 m ²	46" 117 cm	3,575 lbs 1,625 kg	25,235 lbs 11,450 kg	245 lbs/ft ² 1,196 kg/m ²	230 volt, 60 amp Single phase GFCI protected circuit
E550-58 Treadmill	15'0" x 7'10" 457 cm x 239 cm	58" 147 cm	200 ft ²	4,000	2,360 gallons 8,935 liters	88.4 ft ² 8.2 m ²	46" 117 cm	3,700 lbs 1,680 kg	25,110 lbs 11,390 kg	245 lbs/ft ² 1,196 kg/m ²	230 volt, 60 amp Single phase GFCI protected circuit
E700-58	17'0" x 7'5" 518 cm x 226 cm	58" 147 cm	200 ft ²	4,000	2,150 gallons 8,140 liters	95 ft ² 8.8 m ²	46" 117 cm	3,025 lbs 1,375 kg	22,685 lbs 10,290 kg	210 lbs/ft ² 1,010 kg/m ²	230 volt, 60 amp Single phase GFCI protected circuit
E700-58 Treadmill	117'0" x 7'5" 518 cm x 226 cm	58" 147 cm	200 ft ²	4,000	2,100 gallons 7,950 liters	95 ft ² 8.8 m ²	46" 117 cm	3,150 lbs 1,430 kg	22,395 lbs 10,160 kg	210 lbs/ft ² 1,015 kg/m ²	230 volt, 60 amp Single phase GFCI protected circuit

CAUTION: Watkins Wellness suggests a structural engineer or contractor be consulted before the fitness system is placed on an elevated deck.

ELECTRICAL NOTE: On a standard 60 amp system:

The heater will turn off (if on) when the Hydrotherapy jet pump is turned on.

By converting to an 80 amp system heater will remain on even when the Hydrotherapy jet pump is activated.

Ask your **ENDLESS POOLS** dealer for more information.

* **NOTE:** The "Filled weight" and "Dead weight" of the fitness system includes the weight of 10 occupants (assuming an average occupant weight of 175 lbs [80 kg]).

©2022 WATKINS WELLNESS. **ENDLESS POOLS** IS A TRADEMARK OF WATKINS WELLNESS



WatkinsWellness

Feel good. Live well.™

Vista, California
USA



305031.23

305031.23 A (12/22)