



# SUBMITTAL SHEET

## ABV JACKETED BUFFER TANKS

Job Name \_\_\_\_\_

State/Province \_\_\_\_\_ City \_\_\_\_\_

Engineer \_\_\_\_\_

Wholesaler \_\_\_\_\_

Mech. Contractor \_\_\_\_\_

Model No. \_\_\_\_\_

Dimensional Restrictions \_\_\_\_\_

Notes \_\_\_\_\_

\_\_\_\_\_

### Standard Features:

- 5 Year Limited Warranty
- Automatic Air Vent
- Pre-painted Jacket
- Ring Base (for vertical tanks)
- ASME Sec. VIII U Stamp
- 125 PSI Working Pressure
- Steel Tank Construction
- 2" HCFC Free Foam Insulation

### Optional Equipment/Features: (please indicate on page 2):

150 PSI Working Pressure

160 PSI Working Pressure

T&P Gauge

12x16 manway (300 USG and larger)

Lifting Lugs

Seismic Bracing (not available under 250 gallons)

Internal Baffle

(when ordered with 2 upper or 2 lower connections)

### Special Tappings:

NPT: Size \_\_\_\_\_" Quantity \_\_\_\_\_

Size \_\_\_\_\_" Quantity \_\_\_\_\_

Flanged: Size \_\_\_\_\_" Quantity \_\_\_\_\_

Size \_\_\_\_\_" Quantity \_\_\_\_\_

**Please indicate locations on page 2**

## ABV JACKETED BUFFER TANKS

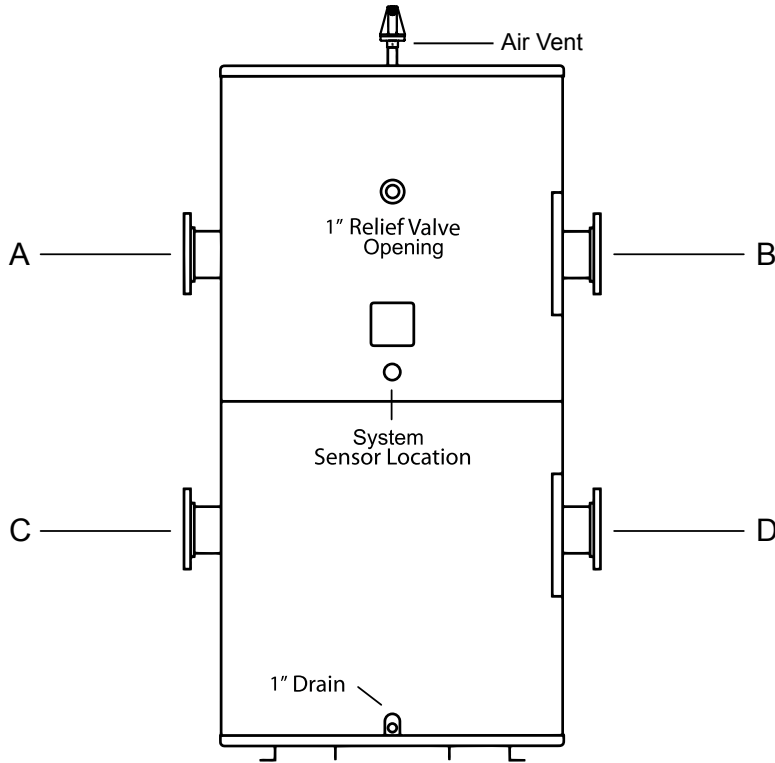

Standard Connections (Illustrated)		
Connection	Location	Size (in)
A	Upper - Left	
B	Upper - Right	
C	Lower - Left	
D	Lower - Right	

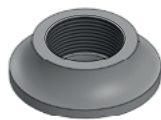

NPT THREAD

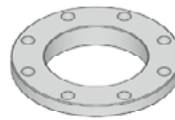

BOLTING FLANGE  
(FFSO, CL150)

DIR: 2000557168

### JACKETED BUFFER TANK HYDRAULIC SEPARATOR

#### STANDARD EQUIPMENT

- ASME Sec. VIII U Stamp
- 125psi (Working Pressure)
- Automatic Air Vent
- 5 Year Limited Warranty
- Pre-painted Jacket
- 2" HCFC Free Foam Insulation

#### OPTIONAL EQUIPMENT

- Temperature Gauge
- Pressure Gauge
- Internal Baffle (Only for 2 Upper or 2 Lower Connections)
- 4" x 6" handhole cleanout opening
- 12" x 16" manway opening (300 gallons and larger) [1,364 litres]
- Extra Tappings
- Flange or NPT Connections
- Lifting Lugs

#### OUTSTANDING STANDARD FEATURES:

- Available in Seven Tank Sizes
- ASME Sec VIII Certified
- U Stamped
- Automatic Air Vent
- Custom Connection Locations

#### 5- YEAR LIMITED WARRANTY



ABV120 - ABV1000

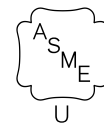

## WHAT IS A BUFFER TANK/HYDRAULIC SEPARATOR?

A Buffer Tank/Hydraulic Separator is designed to maximize the runtime and limit the on/off cycling of a boiler while separating the boiler flow from the system flow. In applications where the minimum system load is less than the minimum output of the boiler there is a high propensity for the boiler to excessively cycle on and off due to the fact that the boiler is delivering more BTU's than the system is requiring. In this case the Buffer Tank is designed to act as a battery for BTU's. The system demand is met by using BTU's that are already stored in the tank and thus delaying the boiler from initiating a heating cycle until a minimum run time can be accomplished.

The Hydraulic Separator aspect of the tank is designed to de-couple the hydronic heating system flow from the boiler flow by acting as a "separator" so that the two independent flows do not affect one another. When the system flow is less than the minimum required boiler flow there will likely be erratic system delivery temperatures and excessive boiler cycling. These adverse affects can cause premature component failure, and in most cases, boiler efficiency will be adversely affected.

## WHEN SHOULD A BUFFER TANK/HYDRAULIC SEPARATOR BE APPLIED?

A Buffer Tank/Hydraulic Separator can be applied to keep the boiler from short cycling in situations where the smallest building demand is less than the minimum rated output of the boiler and/or in situations where system flow is less than the flow required by the boiler.

For example, assume that during a warm spring day there is only a fractional demand for heat where the actual demand is 50,000 BTU/Hr., but the boiler cannot deliver less than 150,000 BTU/Hr at its lowest output. On days that meet this criteria the boiler will cycle excessively because more BTU's are being produced than the distribution system can transfer to the building. A properly sized buffer tank in this situation will limit the number of boiler "on/off" cycles and increase the comfort level of the building by delivering a more constant temperature.

Additionally, during these days of fractional demand the system flow may be less than the boiler flow due to system pumps slowing because the demand is less than the design load. In this case the Hydraulic Separator acts as a decoupling device and the decreased system flow will not affect the operation of the boilers. By effectively separating the system flow from the boiler flow, a more constant delivery temperature, as well as longer boiler operational cycles, can be achieved. Reducing boiler on/off cycles will increase boiler efficiency and reduce maintenance costs.

## HOW IS A BUFFER TANK/HYDRAULIC SEPARATOR SIZED?

A Buffer Tank/Hydraulic Separator is sized to provide a minimum runtime for the boiler plant. Use the equation below to find the properly sized tank for your specific application. Tank connection diameters should be sized to meet the maximum flow requirements of the application.

$$\text{BUFFER TANK CAPACITY} = \frac{\text{DESIRED RUN TIME X (MINIMUM BOILER OUTPUT - MINIMUM SYSTEM LOAD)}}{\text{SYSTEM } \Delta T \times 8.33 \times 60}$$

- Desired Runtime- The Minimum period of time that the boiler should run before cycling off.  
- A. O. Smith recommends a minimum boiler runtime of no less than 10 minutes.
- Minimum Boiler Output- The amount of BTU's that will be delivered at the minimum firing rate of the smallest boiler in the plant.
- Minimum System Load- The absolute smallest heat demand of the building.
- System Delta T- The difference between the system supply temperature and system return temperature.
- 8.33- The weight of one gallon of water.
- 60- The number of minutes in 1 hour

## WHAT WILL THE LEAVING WATER TEMPERATURE BE FROM THE BUFFER TANK/HYDRAULIC SEPARATOR?

At times when the system flow is greater than the boiler flow the system supply temperature can be less than the boiler supply temperature due to the mixing of the temperatures in the tank. The exact system supply temperature can be found by using the formula in Figure 1 (right). This can be helpful when calculating system supply temperatures during high load periods.

## WHAT HAPPENS INSIDE THE BUFFER TANK/HYDRAULIC SEPARATOR?

Depending on the relationship between the system flow and boiler flow, the buffer tank may react in different ways. Find your specific situation in the diagrams below and see the associated flow and thermal distribution patterns inside the Buffer Tank/Hydraulic Separator. As the diagrams show, the design allows for the boiler flow and system flow to work together to maximize boiler efficiency and overall system performance.

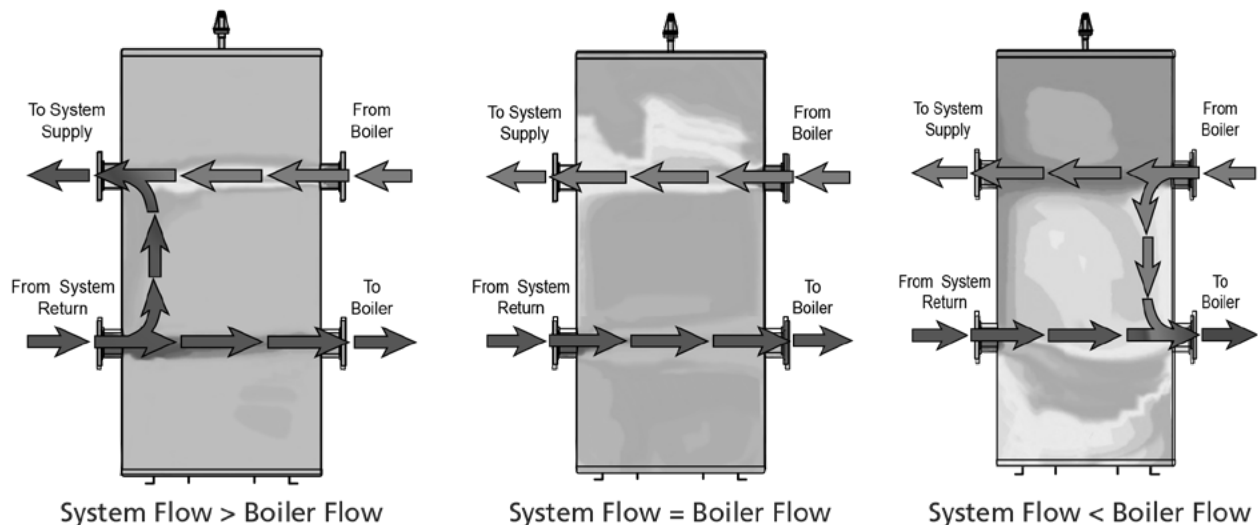

## TYPICAL PIPING ARRANGEMENT FOR BUFFER TANK/HYDRAULIC SEPARATOR IN HYDRONIC SYSTEMS

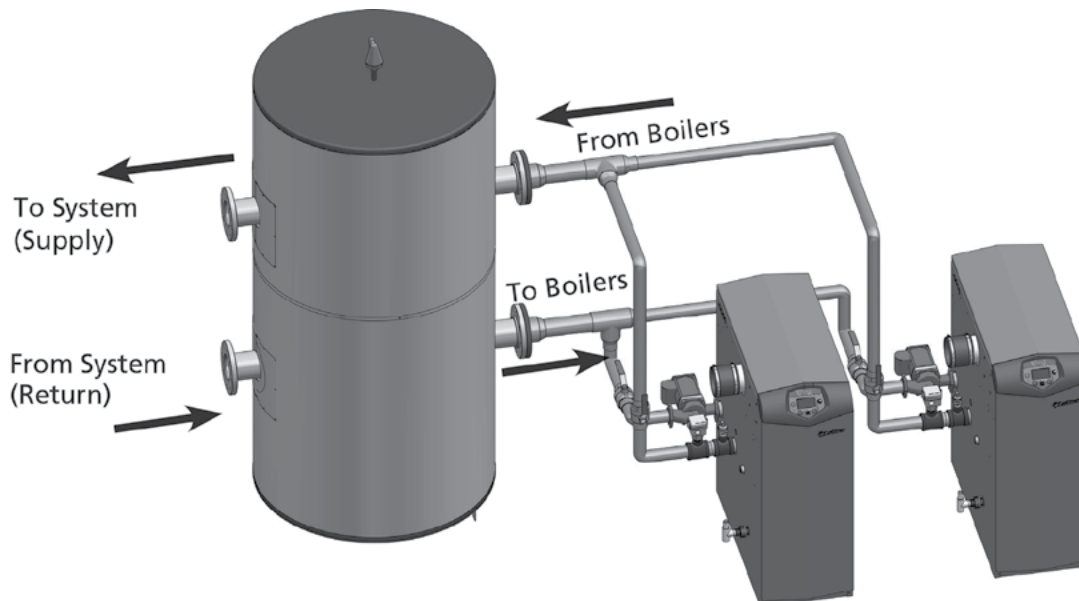

## BUFFER TANK / HYDRAULIC SEPARATOR DIMENSIONS AND SPECIFICATIONS

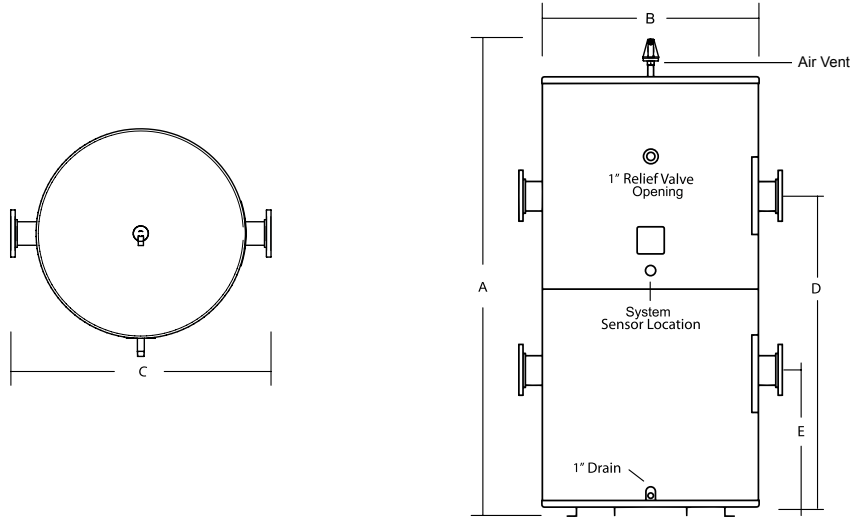

HYDRAULIC SEPARATOR BUFFER TANK W/ UPPER OR LOWER CONNECTIONS							
MODEL NUMBER	CAPACITY USG (L)	A IN (CM)	B IN (CM)	C IN (CM)	D IN (CM)	E IN (CM)	WEIGHT LB (KG)
ABV_-120	120 (454)	64-1/2 (164)	32 (81)	32 (81)	43-3/4 (111)	19-3/4 (50)	500 (227)
ABV_-200	200 (757)	94-1/2 (240)	32 (81)	32 (81)	73-3/4 (187)	19-3/4 (50)	900 (408)
ABV_-325	318 (1,204)	85 (216)	40 (102)	50 (127)	57-1/2 (146)	26-1/2 (67)	1,290 (585)
ABV_-450	432 (1,635)	85 (216)	46 (117)	56 (142)	55 (140)	29 (74)	1,626 (738)
ABV_-500	500 (1,893)	96 (244)	46 (117)	56 (142)	66 (168)	29 (74)	1,765 (801)
ABV_-750	750 (2,839)	109 (277)	52 (132)	62 (157)	77 (196)	31 (79)	2,330 (1,057)
ABV_-1000	1,000 (3,785)	133 (338)	52 (132)	62 (157)	101 (257)	31 (79)	3,010 (1,365)

Notes: Custom Sizes and Configurations are Available, consult Factory for details.  
 Additional Recirculation & Supply/Return Connections Sizes Available, consult Factory for details.  
 Automatic Air vent will add 5" to total tank height.  
 \_ Select connection location: 4 = 2 Upper and Lower Connections; 2 Lower Connections; 2 Upper Connections.

### OPTIONAL CONNECTIONS

FLANGED CONNECTIONS	BOLT PATTERN
76.2 mm (3") NPT	325 - 1,000 only
76.2 mm (3") Bolt Flanged	
101.6 mm (4") Bolt Flanged	
127 mm (5") Bolt Flanged	
152.4 mm (6") Bolt Flanged	
203.2 mm (8") Bolt Flanged	
254 mm (10") Bolt Flanged	
EXTRA TAPPINGS	
25.4, 31.75, 38.1, 50.8, 63.5, 76.2, 101.6 mm (1", 1 1/4", 1 1/2", 2", 2 1/2", 3, 4")	

OPTION CODE:	
ABVU-120-3NTM	M = 150 psi; 6 = 160 psi
	T = T&P Gauge; S = Seismic; Z = T&P Gauge + Seismic*
	N = NPT; B = Bolting Flange
	Number = inch size
	4 = 4 Connections (Upper and Lower); 3 = 3 Connections**; L = Lower Connections; U = Upper Connections; C = Custom Offset Connections**

\*Seismic offered on ABV-325 models and up.  
 \*\*Submittal is required for ordering.

**For Technical Information call 888-599-2837. A. O. Smith Enterprises Ltd. reserves the right to make product changes or improvements without prior notice.**