



Instructions for Use

# **EvoEndo<sup>®</sup> Model LE Single-Use Gastroscope and EvoEndo<sup>®</sup> Controller (EE-C)**

**Rx ONLY** For use by trained physicians only. For in-hospital use.

## **EVOENDO<sup>®</sup> SINGLE-USE ENDOSCOPY SYSTEM**

### **EvoEndo<sup>®</sup> Inc.**



EvoEndo<sup>®</sup> Inc.

888 East Belvidere Road, Suite 212

Grayslake, IL 60030







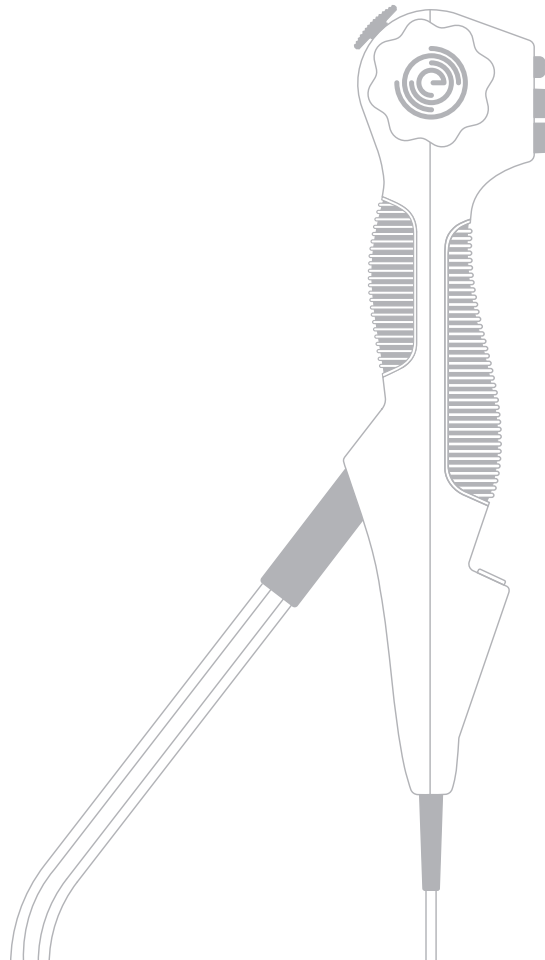







303.223.7445















[www.evoendo.com](http://www.evoendo.com)

LBL-1 Rev. 10.0



## Symbols Used

Sterile Product, Sterilization by ETO	
Single-use product, do not reuse	
Warning	
Consult Instructions for Use	
Do not use if the product sterilization barrier or its packaging is damaged	
Humidity limitation: relative humidity between 30 and 85% in operating environment	
Atmospheric pressure limitation: between 80 and 109 kPa in operating environment	
The product does not contain natural rubber latex	
Only for Indoor Use	
Reference Number	
Lot Number, Batch Code	
Serial Number	
IP30 - Protection against solid objects	
DVI output signal utilizing HDMI connector	

Use By	
Year of Manufacture	
Company Address	
Max OD (3.5 mm)	
Field of view (120 degrees)	
Video connection for the EvoEndo® Scope	
Direct current	
Alternating current	
Symbol of Class II equipment	
Electrical Safety Type BF Applied Part	
Tested to comply with FCC Standards - Medical Equipment	
Waste Bin symbol, indicating that waste must be collected according to local regulation and collection schemes for disposal of electronic and medical waste.	
Potential Equalization (equipotential)	
Caution: Federal law restricts this device to sale by or on the order of a Physician.	

# Contents

## 1. Important Information – Read Before Use

2. System Parts	p6 <b>Parts</b>
3. Use Overview	p9 <b>Overview</b>
4. System Setup	p10 <b>Setup</b>
5. EvoEndo® Scope Operation	p12 <b>Scope</b>
6. EvoEndo® Controller (EE-C) Operation	p17 <b>Controller</b>
7. Cleaning and Disinfection of EvoEndo® Controller	p18 <b>Cleaning</b>
8. Troubleshooting	p19 <b>Help</b>
9. Technical Specifications	p20 <b>Specs</b>

Appendix 1: Electromagnetic Compatibility

Appendix 2. Standards Applied

Appendix 3. Warranty and Replacement Program

# 1. Important Information – Read Before Use

NOTE: Read these safety instructions carefully before using the EvoEndo® Single-Use Endoscopy System. The Instructions for Use may be updated without further notice. Copies of the current version are available online and upon request.

**WARNING:** *EvoEndo® Model LE Gastroscope is a single-use device and must be handled in a manner consistent with accepted medical practice to avoid contamination prior to insertion.*

**WARNING:** *EvoEndo® Single-Use Endoscopy System images must not be used as a single-point of diagnosis. Physicians must interpret and substantiate any finding by additional means and with reference to the patient's clinical characteristics.*

## 1.1. Instructions

Please be aware that these instructions do not explain or discuss clinical procedures. They describe only the basic operation and precautions related to the operation of the EvoEndo® Single-Use Endoscopy System. Before initial use of the EvoEndo® Single-Use Endoscopy System, it is essential for operators to have received sufficient training in clinical endoscopic techniques and to be familiar with the intended use, warnings, cautions, notes, indications, and contraindications mentioned in these instructions.

## 1.2. Intended Use / Indications for Use

The EvoEndo® Model LE Gastroscope is intended for the visualization of the upper digestive tract in adults and pediatric patients, specifically for the observation, diagnosis, and endoscopic treatment of the esophagus, stomach, and duodenal bulb in patients. The gastroscop is a sterile single-use device and can be inserted orally or transnasally. The EvoEndo® Controller is intended for use with an EvoEndo® Endoscope for endoscopic diagnosis, treatment, and video observation.

## 1.3. Intended Use Conditions

The EvoEndo® Single-Use Endoscopy System is for use in a hospital outpatient environment.

Endoscopic diagnostic accessories designed for a minimum working channel width up to 2.0 mm can be used with the EvoEndo® Single-Use Endoscopy System.

## 1.4. Warnings, Cautions and Notes

Throughout these instructions, appropriate warnings, cautions and notes are given describing potential safety hazards associated with the use of the EvoEndo® Single-Use Endoscopy System.

There is no guarantee that instruments selected solely using this minimum instrument channel width will be compatible in combination.

**WARNING:** *Alerts the user to the possibility of injury, death, or other serious adverse reactions associated with the use or misuse of the EvoEndo® Single-Use Endoscopy System.*

**CAUTION:** Alerts the user to the possibility of a problem with the EvoEndo® Single-Use Endoscopy System associated with its use or misuse. Such problems include EvoEndo® Single-Use Endoscopy System malfunction, EvoEndo® Single-Use Endoscopy System failure, damage to the EvoEndo® Single-Use Endoscopy System, or damage to property.

NOTE: Advises owner/operator about important information on the use of this device.

## GENERAL WARNINGS

*Do not use the EvoEndo® Single-Use Endoscopy System if it is damaged in any way.*

*Perform a functional check before using the EvoEndo® Single-Use Endoscopy System (see section 4). Do not use the EvoEndo® Single-Use Endoscopy System if any part of the functional check fails.*

*Do not attempt to clean and reuse the EvoEndo® Scope on another patient as it is a single-use device.*

*The EvoEndo® Single-Use Endoscopy System is not to be used when delivering highly flammable anesthetic gases to the patient. This could potentially cause patient injury.*

*The EvoEndo® Single-Use Endoscopy System is neither MRI safe nor MRI compatible.*

*Do not use the EvoEndo® Single-Use Endoscopy System during defibrillation.*

*When handling the patient, do not simultaneously touch the EvoEndo® Controller power socket and docking connector.*

*Only to be used by skilled physicians trained in clinical endoscopic techniques and procedures.*

*Excessive force should never be used when operating the EvoEndo® Single-Use Endoscopy System.*

*Patients should be adequately monitored at all times during use.*

*Always watch the live endoscopic image when advancing or withdrawing the Scope, operating the bending section, or suctioning. Failure to do so may harm the patient.*

*The EvoEndo® Single-Use Endoscopy System may cause interference or disrupt equipment operations nearby. It may be necessary to adopt procedures for mitigation, such as reorientation or relocation of the equipment or shielding of the room in which it is used.*

*Do not use active endoscopic accessories such as laser probes and electrosurgical equipment in conjunction with the EvoEndo® Single-Use Endoscopy System, as this may result in patient injury or damage to EvoEndo® Single-Use Endoscopy System.*

*The EvoEndo® Single-Use Endoscopy System should not be used in oxygen rich environments.*

*The EvoEndo® Single-Use Endoscopy System should not be used in patients with cardiac pacemakers or active implants.*

*The EvoEndo® Single-Use Endoscopy System should only be used with the Ferric HDMI cable provided with the device.*

*Discard single-use water bottle after each patient. Do not reuse water bottle between patients.*

## GENERAL CAUTIONS

Be careful not to damage the shaft or tip when using sharp devices such as needles in combination with the EvoEndo® Single-Use Endoscopy System.

Be careful when handling the distal tip of the insertion tube and do not allow it to strike other objects, as this may result in damage to the equipment. The lens surface of the distal tip is fragile and visual distortion may occur.

Do not exert excessive force on the bending section as this may result in damage to the equipment. Examples of inappropriate handling of the bending section include:

- Excessive manual twisting.
- Operating it inside an endotracheal tube or in any other case where resistance is felt.

US federal law restricts these devices for sale only by or on the order of a physician.

Keep the EvoEndo® Single-Use Endoscopy System handle dry during preparation and use.

Portable electronic equipment, except for tested accessories, may affect the normal function of the EvoEndo® Single-Use Endoscopy System.

## GENERAL NOTES

Have a suitable backup system readily available for immediate use so the procedure can be continued if a malfunction should occur. EvoEndo® is not responsible for any damage to the system or patient resulting from incorrect use.

## 2. System Parts

Before you install and use the system please ensure that the following EvoEndo® items are available:

- EvoEndo® Model LE 110 Single-Use Gastroscope - Part Number 1001
- EvoEndo® Model LE 85 Single-Use Gastroscope - Part Number 1021
- EvoEndo® Controller (EE-C) - Part Number 1002
- Medical-Grade Power Supply - Part Number 1003
- EvoEndo® Instructions for Use - Part Number 1000
- Ferric HDMI Cable - Part Number 1004

You will also need (not supplied by EvoEndo®):

- Medical-Grade Monitor (minimum size recommended is 27 inch, 1080p HD resolution)

The EvoEndo® Single-Use Endoscopy System consists of a sterile single-use EvoEndo® Scope and reusable Controller (EE-C).

**WARNING** To avoid the risk of cross-contamination relating to the reusable electronic components, ensure EE-C is cleaned and disinfected using appropriate cleaning solutions to meet hospital cleaning procedures.

### 2.1. EvoEndo® Model LE Single-Use Gastroscope

#### 2.1.1 Packaged System

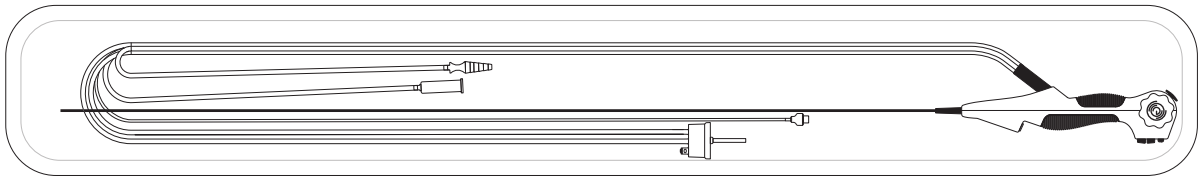

#### 2.1.2 Device Overview & Connections

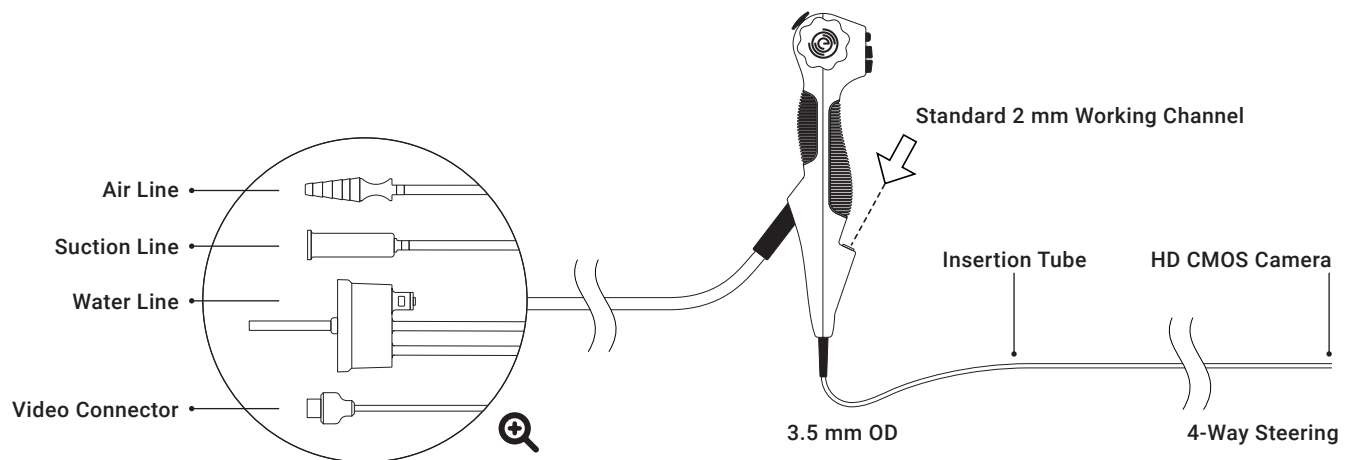

2.1.3 Handle Features

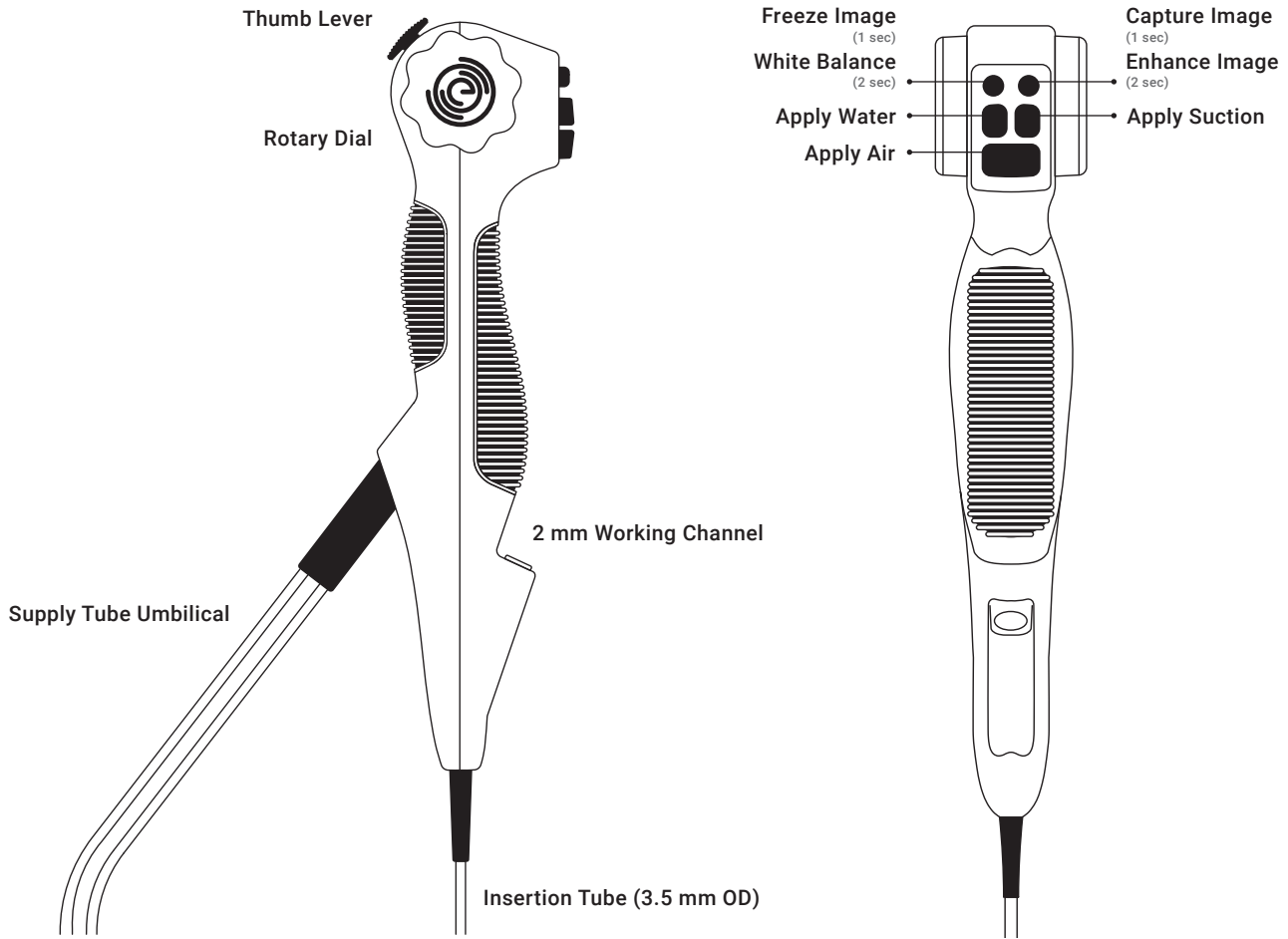

Parts

2.1.4 Tip Steering Controls

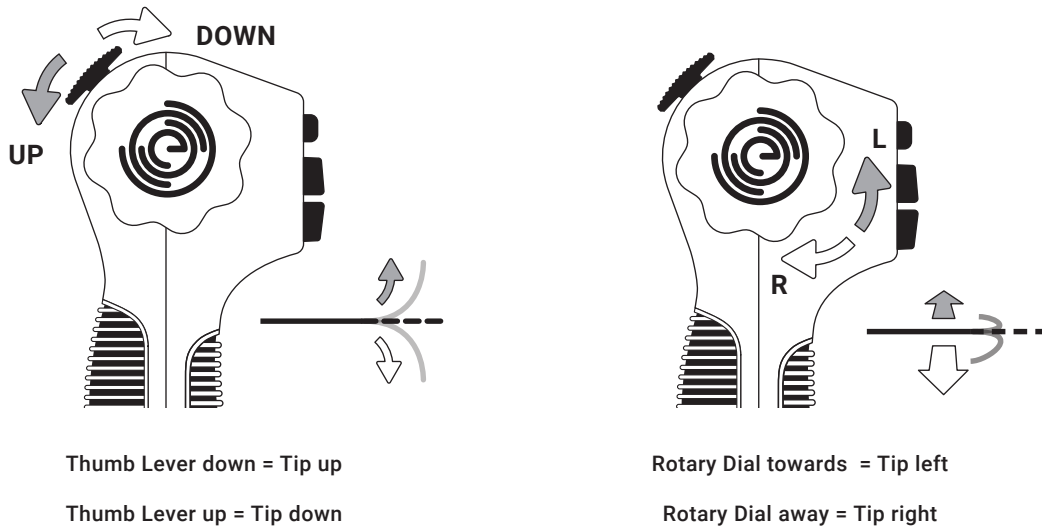

## 2.2. EvoEndo® Controller (EE-C)

The EvoEndo® Controller (EE-C) processes the live image feed from the EvoEndo® Scope. The device uses standard 110V wall power via the power supply included. It contains an HDMI port for direct output to a medical-grade monitor and a USB 3.0 port for connection to third-party software systems. The EvoEndo® Scope includes a video connector which plugs into the Controller at the Scope Video Input connector.

NOTE: Place on a secure table or cart away from water.

NOTE: When ON a green LED will illuminate.

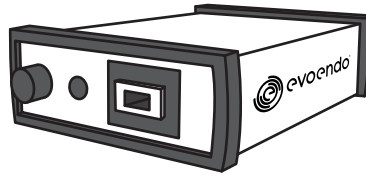

### 2.2.1 Controller Front

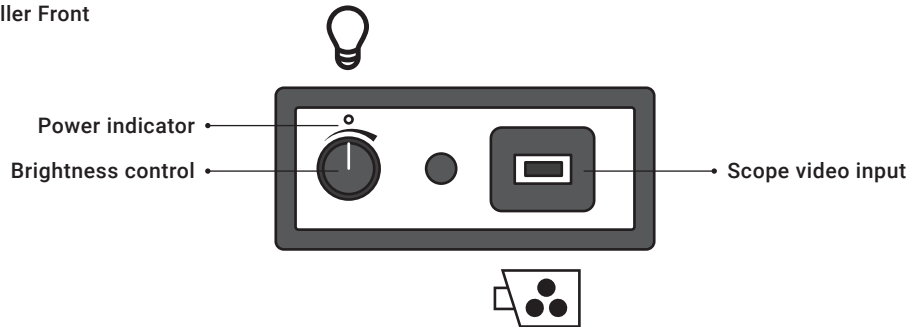

### 2.2.2 Controller Rear

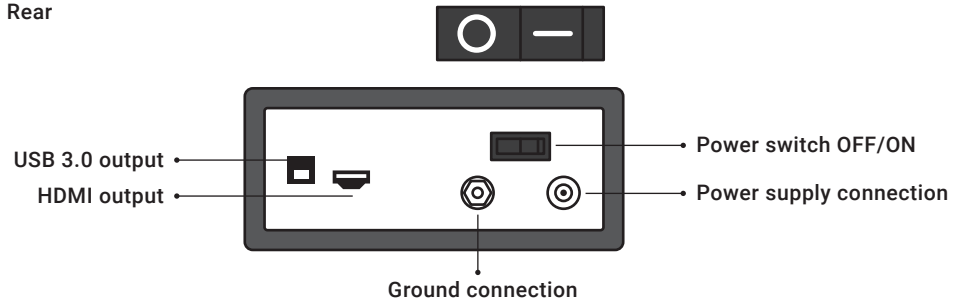

## 2.3. EvoEndo® Controller Power Supply

This power supply is fitted with a country-specific plug and powers the EE-C only.



### 3. Use Overview

#### 3.1. Unpack and Inspect

- Device packaging not damaged?*
- Device free from defects and not damaged during unpacking?*
- Controller cleaned from previous use?*

#### 3.2. Connect and Test

- Can make appropriate electrical connections?*
- Image quality sufficient?*
- Can make appropriate tube/supply connections?*
- Successfully ID buttons for air/water/suction?*
- Air/water/suction functioning correctly?*
- Successfully ID buttons for freeze image, white-balance, capture image, enhance image?*
- Visually checked vertical tip control (thumb lever)?*
- Visually checked horizontal tip control (rotary dial)?*
- Endoscopic accessories fit the working channel?*

#### 3.3. Perform Endoscopic Procedure

#### 3.4. Withdraw, Dispose, and Clean

- Remove any endoscopic accessories*
- Discard Scope*
- Recycle plastic packaging tray*
- Clean and disinfect Controller*

## 4. System Setup

**WARNING:** Do not use the EvoEndo® Scope if it is damaged in any way or if any part of the functional check described below fails.

**WARNING:** Do not use a knife or sharp instrument to open the pouch or cardboard box.

**CAUTION:** The EvoEndo® Single-Use Endoscopy System consists of the parts described in Section 2. They may only be replaced by EvoEndo® authorized parts. Failure to comply with this may reduce safety and efficiency.

**NOTE:** Have a suitable backup system readily available for immediate use so the procedure can be continued if a malfunction should occur.

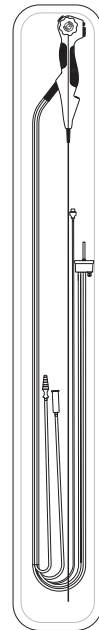

### 4.1. Inspect the EvoEndo® Scope

- 4.1.1. Check that the pouch is not damaged and that the seal is intact.
- 4.1.2. Unpack the device and check that there are no impurities on the product.
- 4.1.3. Check that there is no evidence of shipping damage or other damage such as rough surfaces, sharp edges, or protrusions which may harm the patient.

### 4.2. Inspect and Test the EvoEndo® Controller (EE-C)

- 4.2.1. Check the power supply is present and free from damage.
- 4.2.2. Closely examine the EvoEndo® Controller for any damage.
- 4.2.3. Find the Equipotential Terminal on rear side of VCU. An Equipotential Terminal is provided to optionally connect to a hospital ground/earth system.
- 4.2.4. Locate the nearest wall socket before start of the procedure. Plug in the power supply to the wall socket and to the VCU.

**CAUTION:** Position the power supply cable where it does not present a trip-hazard. Do not place any objects on the power cord.

**CAUTION:** If the EvoEndo® Controller is used adjacent to or stacked with other equipment, observe and verify normal operation prior to using it. Consult Appendix 1 for guidance on placing the EvoEndo® Controller.

- 4.2.5. Switch ON by pressing the on/off button. Switch OFF after test.

**NOTE:** When ON a green LED will illuminate.

### 4.3. Test Live Video Image

**CAUTION:** Ensure the EE-C is powered OFF during all cable connection.

- 4.3.1. Connect EvoEndo® Scope to the EvoEndo® Controller by plugging the video connector on the EvoEndo® Scope into the appropriate socket on the front of the Controller.
- 4.3.2. Connect the Controller to an HD-rated medical-grade monitor with included Ferric HDMI cable (Part 1004).

**NOTE:** The Controller should only be used with the Ferric HDMI cable provided.

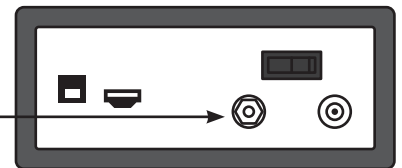

ON

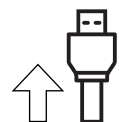
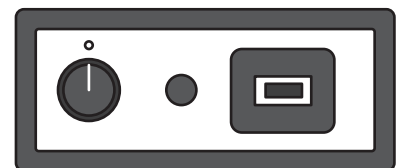
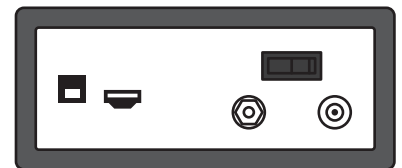

- 4.3.3. Power ON the monitor and the Controller.
- 4.3.4. Point the distal end of EvoEndo® Scope towards an object, e.g. the palm of your hand.
- 4.3.5. Verify that a live video image appears on the screen.

NOTE: If the object cannot be seen clearly, wipe the lens at the distal end using a clean cloth.

NOTE: A medical-grade anti-fog liquid may also be used on the distal end.



#### 4.4. Connect and Test EvoEndo® Scope Supply Lines

- 4.4.1. Identify the water supply line on the EvoEndo® Scope and connect via standard screw-top fitting to a standard 250 ml (minimum) single-use sterile water or saline bottle.

NOTE: Bottle must remain upright throughout the procedure.

- 4.4.2. Identify the air supply line on the EvoEndo® Scope and connect using a push-fit to an air system (carbon dioxide) rated 2-3 L/Flow (50 psi standard wall pressure) or 8 psi continuous regulated pressure (recommended).
- 4.4.3. Identify the suction line and connect using a push-fit. Ensuring a suction vacuum of 200 mmHg or less.

#### Setup

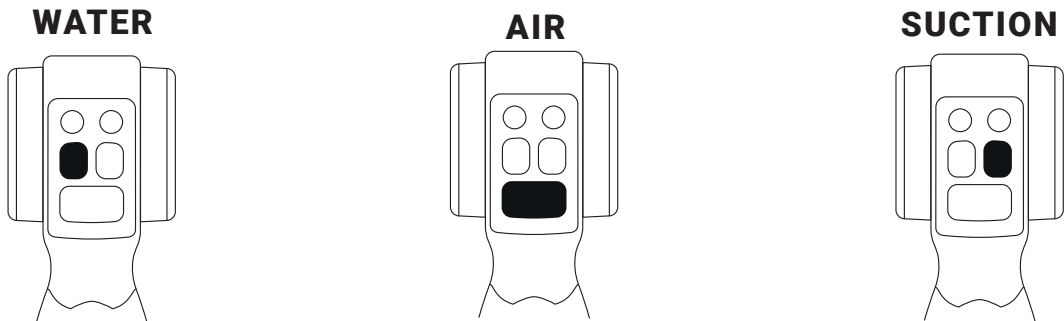
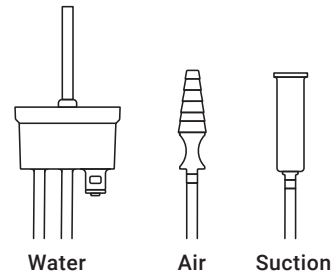

- 4.4.4. With the distal tip directed into the packaging tray or similar disposable vessel, press and hold the water button to check for continuous flow and expected rate.
- 4.4.5. Place the distal tip in the water previously dispensed into the packaging tray then press and hold the air button to check flow.
- 4.4.6. Place the distal tip back into the dispensed water and press the suction button to check suction function.

- 4.4.7. Verify that any endoscopic accessories to be used can pass through the working channel without excessive resistance.

**CAUTION:** Ensure any endoscopic accessory used is less than 2 mm outer-diameter and at least 1.1 m working length.

**NOTE:** Add several drops of silicon oil to the channel if resistance is felt.

**WARNING:** Active endoscopic accessories such as laser probes and electrosurgical equipment are not compatible with the EvoEndo® Scope and should not be used under any circumstances.

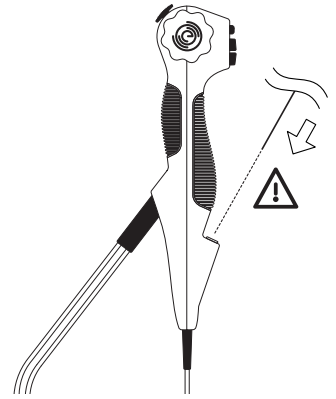

## 5. EvoEndo® Scope Operation

**WARNING:** Excessive force should never be used when operating EvoEndo® Scope.

**WARNING:** If any malfunction should occur during the endoscopic procedure, stop the procedure immediately, put the distal tip in its neutral non-angled position, and slowly withdraw the EvoEndo® Scope without touching the bending lever.

**WARNING:** Always observe the live endoscopic image while withdrawing the EvoEndo® Scope.

**WARNING:** The temperature of the distal end of the endoscope may exceed 41°C (106°F) and reach up to 43°C (110°F) due to heating of the LEDs. Long, sustained contact with the mucosal membrane may cause mucosal injury. Avoid long periods of contact between the tip of the device and the mucosal membrane. Always maintain a suitable distance necessary for adequate viewing while using the minimum level of illumination for the minimum amount of time.

### 5.1. Holding the EvoEndo® Scope

The handle of the EvoEndo® Scope can be held in either hand.

Use the thumb to move the up/down control lever and the index finger to operate the air/water/suction electronic buttons.

The index finger can also be used to apply left right motion of the distal tip via rotation of the dials while the thumb moves the device tip up/down.

The hand that is not holding the handle can be used to advance the Scope Insertion Tube into the patient's mouth or nose using a pencil-like grip.

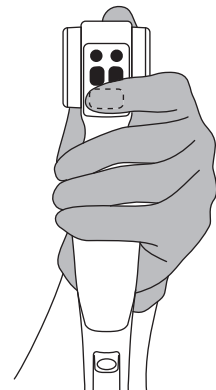
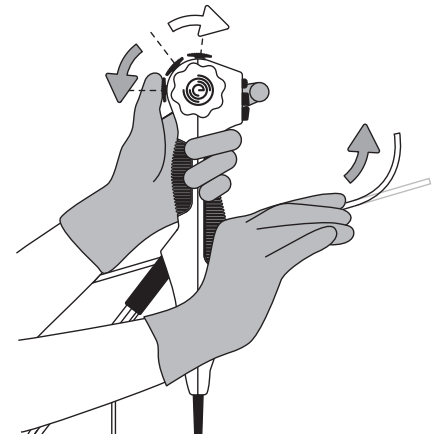

## 5.2. Manipulating the Tip of the EvoEndo® Scope

The thumb control lever is used to flex and extend the tip of the EvoEndo® Scope in the vertical plane.

Moving the control lever downward will make the tip bend anteriorly (flexion).

Moving it upward will make the tip bend posteriorly (extension).

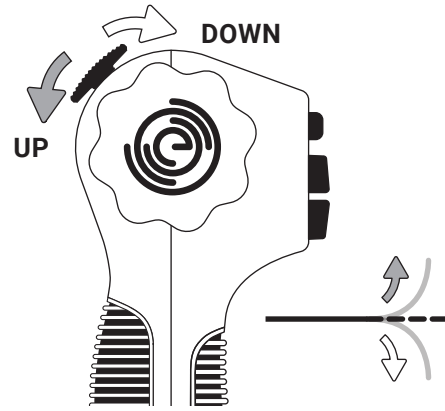

Thumb lever down = Tip up

Thumb lever up = Tip down

Scope

The Index Control Dials (mirror images of each other) are used to flex and extend the tip of the EvoEndo® Scope in the horizontal plane.

Moving the control dials in either direction will make the tip bend laterally.

CAUTION: The endoscope catheter should be held as straight (planar) as possible at all times in order to maintain optimal tip control.

CAUTION: The device will tolerate twisting, but excessive twisting could break the catheter steering mechanism or decrease efficacy of steering.

CAUTION: Do not exert excessive force on the bending section as this may result in damage to the equipment. Examples of inappropriate handling of the bending section include:

- Excessive manual twisting along the insertion tube.
- Operating it inside an endotracheal tube.
- Operation where significant resistance is felt.

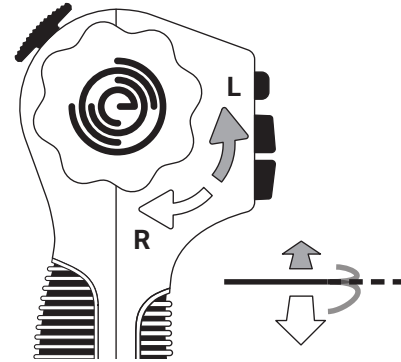

Rotary dial towards = Tip left

Rotary dial away = Tip right

## 5.3. Insertion of the EvoEndo® Scope

CAUTION: Lubricate the insertion tube with a medical-grade lubricant to ensure the lowest friction when the EvoEndo® Scope is inserted into the patient.

CAUTION: When inserting the EvoEndo® Scope orally, it is recommended to use a mouthpiece to protect the Scope from damage.

NOTE: If the camera image of the EvoEndo® Scope becomes unclear, the tip can be cleaned by gently rubbing the tip against the mucosal wall or fully withdrawing the Scope and cleaning the tip with an anti-fog liquid or disinfection wipe.

#### 5.4. Instillation of Fluid

With a standard 250 ml (minimum) screw-top single-use water container connected, press and hold the water button to add water to the investigation site.

### WATER

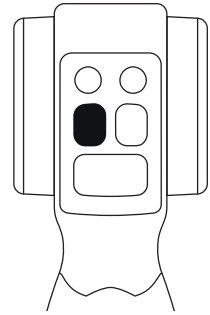

In addition to the integrated water supply function, fluids may also be instilled directly down the working channel by inserting a blunt tip needle attached to a luer lock syringe into the working channel at the top of the EvoEndo® Scope.

- 5.4.1. Insert the syringe completely into the working channel port or the introducer. Failure to do so may result in the fluid spilling from the working channel port.
- 5.4.2. Press the plunger to instill fluid.

**CAUTION:** Make sure you do not apply suction during this process, as this will direct the instilled fluids into the suction collection system.

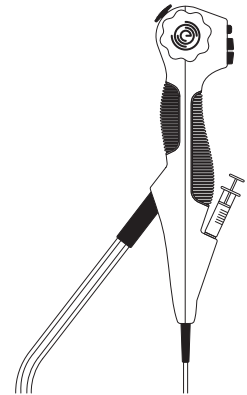

#### 5.5. Aspiration

Suction can be applied by pressing the suction button with the index finger.

**WARNING:** Ensure that the suction connector on the EvoEndo® Single-Use Endoscopy System is only connected to a medical-grade suction apparatus.

**WARNING:** Use a suction vacuum of 200 mmHg or less. Too high a vacuum may lead to difficulty terminating suction.

### SUCTION

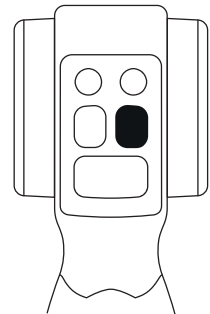

#### 5.6. Insufflation

To achieve air insufflation, press and hold the air button for continuous flow.

**WARNING:** Ensure the use of short bursts of insufflation to reduce the risk of over insufflation and the associated risks of gas embolism.

### AIR

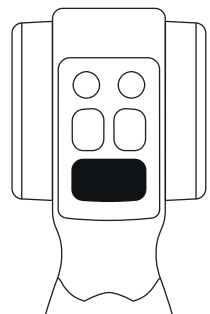

## 5.7. Imaging Buttons

### 5.7.1. Freeze Image

To freeze the image, use a single short press (1 second) of the button directly above the water button.

### 5.7.2. White Balance Reset

White balance is factory-optimized for each device. However, if this setting is adjusted or problematic then press and hold (2 seconds) the button directly above the water button to reset the white balance.

### 5.7.3. Capture Image

To capture an image to a third-party system, use a single short press (1 second) of the button directly above the suction button.

### 5.7.4. Enhance Image

To adjust luminance levels and bring out details in the dark regions of the image, use a single long press (2 seconds) of the button directly above the water button. Pressing this button will toggle between two different gamma levels.

## 5.8. Insertion of Endoscopic Accessories

**WARNING: Do not use active endoscopic accessories such as laser probes and electro-surgical equipment in conjunction with the EvoEndo® Single-Use Endoscopy System, as this may result in patient injury or damage to EvoEndo® Scope.**

**WARNING: To maintain patient safety and the safety of the end user, only medical approved accessories are to be used.**

**WARNING: Do not advance or withdraw EvoEndo® Scope or operate the bending section while endoscopic accessories are protruding from the distal end of the working channel, as this may result in injury to the patient.**

**CAUTION:** Never use excessive force when advancing or withdrawing an endoscopic accessory inside the working channel. Failure to observe the above may result in damage to the working channel.

**CAUTION:** Ensure any endoscopic accessory used is less than 2 mm outer-diameter and at least 1.1 m working length.

**CAUTION:** Inspect the endoscopic accessory before using it. If there is any irregularity in its operation or external appearance, replace it.

**CAUTION:** Insert the endoscopic accessory into the working channel port and advance it carefully through the working channel until it can be seen on the external monitor.

**CAUTION:** Extra care should be taken when steering the EvoEndo® Scope if accessories are protruding from the distal tip.

**NOTE:** There is no guarantee that instruments selected solely using this minimum instrument channel width will be compatible in combination.

## FREEZE IMAGE

1 sec

## WHITE BALANCE

2 sec

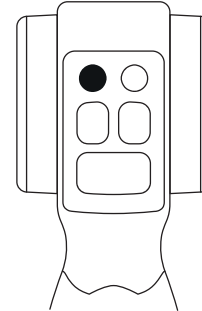

Scope

## CAPTURE IMAGE

1 sec

## ENHANCE IMAGE

2 sec

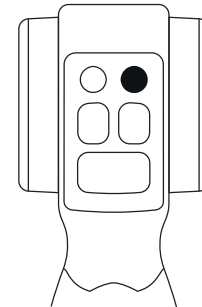

## 5.9. Withdrawal of the EvoEndo® Scope

- 5.9.1. Prior to removal, check the tip position of any endoscopic accessories to ensure safest possible removal.
- 5.9.2. Slowly withdraw the EvoEndo® Scope while watching the live image to check safe extraction.

**WARNING:** While withdrawing the EvoEndo® Scope, do not operate the Thumb Lever or Dials to allow the distal tip to exit in a neutral position.

**NOTE:** If the EvoEndo® Scope is used more than once on the same patient during the same procedure, place it on a sterile surface in between sessions.

## 5.10. After Use

- 5.10.1. Remove the video connector cable to disconnect the EvoEndo® Scope.
- 5.10.2. Disconnect all supply lines from the EvoEndo® Scope.
- 5.10.3. Dispose of the EvoEndo® Scope in accordance with local guidelines for collection of infected medical devices with electronic components.
- 5.10.4. Dispose of any other single-use components (e.g., water bottle, suction canister, etc.) in accordance with hospital guidelines.
- 5.10.5. Switch off Controller.
- 5.10.6. Clean and disinfect the Controller as described in Section 7.

**WARNING:** The EvoEndo® Scope is a single-use device and must not be reprocessed under any circumstances.

**WARNING:** The EvoEndo® Scope is considered contaminated after use and must be disposed of in accordance with local guidelines for collection of infected medical devices with electronic components.



## 6. EvoEndo® Controller (EE-C) Operation

**WARNING: Explosion Hazard - Do not use in the presence of flammable anesthetics. Do not store liquids on or above this unit. Type BF Class II Equipment when used with the EvoEndo® Scope.**

### 6.1. EvoEndo® Controller Output Modes

#### 6.1.1. Basic - direct access (HDMI)

Live image available while connected to a medical-grade HDMI compatible monitor.

NOTE: For optimal performance, use a medical-grade monitor that is 27-inch minimum, HD 1080p or higher resolution, and 1000 nits brightness.

No video recording or image capture is available in direct access mode.

### 6.2. EvoEndo® Controller Setup

#### 6.2.1. Connect EvoEndo® power supply (supplied) and Ferric HDMI cable (supplied) on the rear of the Controller.

NOTE: The Controller should only be used with the Ferric HDMI cable provided.

#### 6.2.2. Connect the EvoEndo® Scope using the Scope Video Input connector on the front of the Controller.

#### 6.2.3. Press the power switch on the rear of the Controller to ON position.

#### 6.2.4. Conduct procedure, adjusting the image brightness as required using the rotary dial on the front of the Controller.

NOTE: The Controller and live image may be left connected and powered on during Scope extraction as part of multiple investigations of the same patient within the same session.

#### 6.2.5. With EvoEndo® Scope removed from patient, press Button to OFF Position.

#### 6.2.6. Disconnect the EvoEndo® Scope and process as waste.

#### 6.2.7. Disconnect the HDMI cable.

#### 6.2.8. Clean and disinfect the EvoEndo® Controller as described in Section 7.

**WARNING: Do not attempt to open or service the EvoEndo® Controller; refer to Warranty statement in Appendix 3 and contact EvoEndo® for a replacement.**

Controller

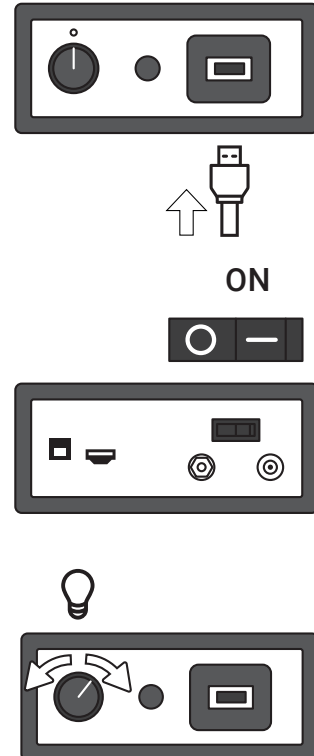

## 7. Cleaning the EvoEndo® Controller

The EvoEndo® Controller must be cleaned and/or disinfected per hospital policy before and after each use. Ensure the Controller is cleaned thoroughly prior to first use.

### 7.1. Cleaning

7.1.1. Ensure the Controller is disconnected.

7.1.2. Use a standard cleaning detergent to clean and/or disinfect the EvoEndo® Controller according to hospital policy.

7.1.3. After cleaning and/or disinfecting, the EvoEndo® Controller must be submitted to the pre-check procedure described in section 4.2.

**WARNING:** Avoid getting the device wet to prevent damaging internal electronic components.

**WARNING:** Do not attempt to clean and reuse the EvoEndo® Scope as it is a single-use device.

**WARNING:** Clean and disinfect the medical-grade monitor after each use according to the relevant manufacturer guidelines.

**WARNING:** Disconnect EvoEndo® Controller from any mains power supply, remove any accessories, and make sure the Controller is turned off before cleaning and disinfecting.

**WARNING:** Do not spray liquid directly on the Controller.

### Cleaning

**NOTE:** Between procedures, the EvoEndo® Controller must be stored in accordance with local guidelines.

## 8. Troubleshooting

If problems occur with the system, please use this trouble-shooting guide to identify the cause and correct the error.

### 8.1. No live image

Cause:	Action:
EvoEndo® Scope not securely connected to EvoEndo® Controller	Check connections of EvoEndo® Scope video connector to Controller
EvoEndo® Controller and EvoEndo® Scope have communication problems	Check rear connections from Controller to video output (HDMI)
EvoEndo® Scope or Controller is damaged	Replace EvoEndo® Scope or EvoEndo® Controller

### 8.2. Low picture quality

Cause:	Action:
Dirt or debris on the distal tip of the Scope	Clean end of Scope with microfiber sterile cloth, gauze, or cotton swab
Hardware poor connection	Turn EvoEndo® Controller off and on, check connections, troubleshoot per third-party system instructions
Scratched optical mechanism on Scope	Replace Scope

### 8.3. Absent or reduced suction capability

Cause:	Action:
Channel blocked	Flush channel with 10 ml of sterile water, clean channel with endoscopic brush of appropriate size, or replace Scope
Suction source is malfunctioning	Replace or try new suction source of supply tubing

Help

### 8.4. Difficult to insert endoscopic accessory through the channel

Cause:	Action:
Channel blocked	Clean Scope channel with 10 ml of sterile water or endoscopic brush of appropriate size, or replace Scope
Accessory is too big	Use proper size accessory for 2 mm channel
Backflow valve is not functioning	Attempt puncture of valve with sterile blunt device or replace Scope
Distal tip not in neutral position	Adjust mechanisms to achieve neutral position

## 9. Technical Product Specifications

### 9.1. EvoEndo® Model LE Single-Use Gastroscope Specifications

<b>Optical System</b>	
Field of View	120° Diagonal, 87.5° Horizontal
Depth of Field	2.5 mm - 25 mm
Illumination method	LED
<b>Insertion Portion</b>	
Bending section	210° Up, 90° Down, 100° Left, 100° Right
Insertion tube diameter	3.5 mm (0.14")
Distal end diameter	3.5 mm (0.14")
Maximum diameter of insertion portion	3.5 mm (0.14")
Working length	Model LE 85 = 85 cm (33.5") Model LE 110 = 1.1 M (43.3")
<b>Channel</b>	
Average inner diameter	2.0 mm (0.078")
Minimum instrument channel width <sup>4</sup>	2.0 mm (0.078")
Suction connector	
Connecting tube inner diameter	Ø7 mm +/- 1 mm
<b>Air Connector</b>	Connects to 1/4"- 3/8" supply lines
<b>Water Connector</b>	Connects to bottle with 1.25" top
<b>Suction Connector</b>	Connects to standard 6 mm suction device
<b>Operating Environment</b>	
Temperature	10 ~ 40°C (50 ~ 104°F)
Relative humidity	30 ~ 85%
Atmospheric pressure	80 ~ 109 kPa
<b>Storage and Transportation</b>	
Temperature	10 ~ 40°C (50 ~ 104°F)
Relative humidity	30 ~ 85%
Atmospheric pressure	80 ~ 109 kPa
<b>Sterilization</b>	
Method of sterilization	EtO

## 9.2. EvoEndo® EE-C Specifications

Power requirement 12V 1.0A DC input	
<b>Operating Environment</b>	
Temperature	10 ~ 40° C (50 ~ 104° F)
Relative humidity	30 ~ 85%
IP Protection Classification	IP30
Atmospheric pressure	80-109 kPa
Altitude	≤ 2000 m
<b>Dimensions</b>	
Width	15.0 cm
Height	6.0 cm
Length	21.5 cm
Weight	2 lbs 5 oz (1.1 kg)
DVI Output connection	HDMI
<b>Storage and transportation</b>	
Temperature	10 ~ 40°C (50 ~ 104°F)
Relative humidity	30 ~ 85%
Atmospheric pressure	80-109 kPa

## 9.3. EvoEndo® EE-C Power Supply Specifications

<b>Electrical Power</b>	
Power requirement	100 - 240V AC; 50-60Hz; 0.5A
Power out	12V DC; 1.0A
<b>Operating Environment</b>	
Temperature	0 ~ 40° C (32 ~ 104° F)
<b>Storage</b>	
Temperature	-20 ~ 85°C (-4 ~ 185° F)
Relative humidity	10 ~ 90%
<b>Plugs</b>	
Between the power supply and EvoEndo® EE-C	Ø5.5 mm DC jack connector

# Appendix 1. Electromagnetic Compatibility

## Essential Performance Statement

The EvoEndo® Single-Use Endoscopy System provides live continuous images in color, at resolution specified by the camera Manufacturer. During imposed interference the image may distort or diminish, i.e., flicker, display as grayscale or less intensity but will recover within 5 seconds after the interference has ceased. Operator may recycle power to restore functionality (in case the video unit is frozen). If up to three power recycles are necessary, operator should cancel procedure and restart once imposed interference ceases. The device use is not life threatening, therefore it is acceptable to recycle power and start over. Visual corroboration of quality is an acceptable method.

Like other electrical medical equipment, the EvoEndo® Single-Use Endoscopy System requires special precautions to ensure electromagnetic compatibility (EMC) with other electrical medical devices. To ensure electromagnetic compatibility the EvoEndo® Single-Use Endoscopy System must be installed and operated according to the EMC information provided in this manual.

The EvoEndo® Single-Use Endoscopy System has been designed and tested to comply with IEC 60601-1-2 requirements for EMC with other devices.

**WARNING:** *Electronic equipment may affect the normal function of the EvoEndo® Single-Use Endoscopy System.*

**WARNING:** *The EvoEndo® Single-Use Endoscopy System consists of the parts described in section 2. They may only be replaced by authorized parts. Failure to comply with this may reduce safety and efficiency.*

**WARNING:** *Use of this equipment adjacent to or stacked with other equipment should be avoided because it could result in improper operation. If such use is necessary, this equipment and the other equipment should be observed to verify that they are operating normally.*

## Cables Provided with the EvoEndo® System

Cable	Maximum Length
Ferric HDMI Cable - Part Number 1004	6 ft
Medical-Grade Power Supply - Part Number 1003	5 ft

**WARNING:** *Use of accessories, transducers, and cables other than those specified or provided by the manufacturer of this equipment could result in increased electromagnetic emissions or decreased electromagnetic immunity of this equipment and result in improper operation.*

## Guidance and Manufacturer's Declaration: Electromagnetic Emissions

The EvoEndo® Single-Use Endoscopy System is intended for use in the electromagnetic environment specified below. The customer or the user of EvoEndo® Single-Use Endoscopy System shall ensure that it is used in such environment.

Emission Test	Compliance	Electromagnetic Environment - Guidance
RF emissions CISPR 11	Group 1	This instrument is an unintentional radiator. Hence RF energy it generates is a byproduct of its internal functions. While the instrument complies with the limit to which it was tested, it may cause interference.
Radiated emissions CISPR 11	Class A	This instrument's RF emissions are very low and not likely to cause any interference in nearby electronic equipment.
Mains terminal conducted emissions CISPR 11		
Harmonic emissions IEC 61000-3-2	Class A	This instrument's harmonic emissions are low and not likely to cause interference in a typical commercial power grid to which this instrument is connected.
Voltage fluctuations / flicker emissions IEC 61000-3-3	Complies	This instrument stabilizes its own radio variability and has no effect, such as flicker in lighting apparatus.

NOTE: The EMISSIONS characteristics of this equipment make it suitable for use in industrial areas and hospitals (CISPR 11 Class A). If it is used in a residential environment (for which CISPR 11 class B is normally required) this equipment might not offer adequate protection to radio-frequency communication services. The user might need to take mitigation measures, such as relocating or reorienting the equipment.

## Guidance and Manufacturer's Declaration: Electromagnetic Immunity

The EvoEndo® Single-Use Endoscopy System is intended for use in the electromagnetic environment specified below. The customer or the user of the EvoEndo® Single-Use Endoscopy System shall ensure that it is used in such an environment.

Immunity Test	IEC 60601 Test Level	Compliance Level	Electromagnetic Environment - Guidance
Electrostatic Discharges IEC 61000-4-2	Contact: $\pm 8$ kV Air: $\pm 15$ kV	Same as test level	Floors should be made of wood, concrete, or ceramic tile that hardly produces static. If floors are covered with synthetic material that tends to produce static, the relative humidity should be at least 30%.
Electrical Fast Transients and Bursts IEC 61000-4-4	$\pm 2$ kV for power supply lines	Same as test level	Mains power quality should be that of a typical commercial (original condition feeding the facilities) or hospital environment.
Surges IEC 61000-4-5	Differential mode: $\pm 0.5, \pm 1$ kV Common mode: $\pm 0.5, \pm 1, \pm 2$ kV	Same as test level	Mains power quality should be that of a typical commercial or hospital environment.
Voltage Dips and Interruptions IEC 61000-4-11	> 95 % for 0.5 cycles > 95 % for 1 cycle 30 % for 25/30 (50 Hz) cycles > 95 % for 250 (50 Hz) cycles	Same as test level	Mains power quality should be that of a typical commercial or hospital environment. If the user of this instrument requires continued operation during power mains interruptions, it is recommended that this instrument be powered from an uninterruptible power supply or a battery.
Rated Power Frequency Magnetic Field IEC 61000-4-8	30 A/m	Same as test level	It is recommended to use this instrument by maintaining enough distance from any equipment that operates with high current.

## Guidance and Manufacturer's Declaration – Electromagnetic Immunity

The EvoEndo® Single-Use Endoscopy System is intended for use in the electromagnetic environment specified below. The customer or the user of EvoEndo® Single-Use Endoscopy System shall ensure that it is used in such environment.

**WARNING: Portable RF communications equipment (including peripherals such as antenna cables and external antennas) should be used no closer than 30 cm (12 inches) to any part of the EvoEndo® Single-Use Endoscopy System, including cables specified by the manufacturer. Otherwise, degradation of the performance of this equipment could result.**

Immunity Test	IEC 60601 Test Level	Compliance	Electromagnetic Environment – Guidance
Conducted Disturbances, induced by RF fields IEC 61000-4-6	3 V rms outside the ISM band, 6 V rms in the ISM band (150KHz – 80MHz)	3 V (V1)	Recommended separation distance $d = \left[ \frac{3.5}{V_1} \right] \sqrt{P}$
Radiated RF IEC 61000-4-3	3 V/m (80 MHz – 2.7 GHz)	3 V/m (E1)	$d = \left[ \frac{3.5}{E_1} \right] \sqrt{P}$

Definition: Where "P" is the maximum output power rating of the transmitter in watts (W) according to the transmitter manufacturer and "d" is the recommended separation distance in meters (m).

### NOTES

- At 80 MHz and 800 MHz, the higher frequency range applies.
- These guidelines may not apply in all situations. Electromagnetic propagation is affected by absorption and reflection from structures, objects, and people.
- Interference may occur in the vicinity of equipment marked with the following symbol: 
- Field strengths from fixed RF transmitters, as determined by an electromagnetic site survey, should be less than the compliance level in each frequency range.
  - <sup>a</sup> Field strengths from fixed transmitters, such as base stations for radio (cellular/cordless) telephones and land mobile radios, amateur radio, AM and FM radio broadcast, and TV broadcast, cannot be predicted theoretically with accuracy. To assess the electromagnetic environment due to fixed RF transmitters, an electromagnetic site survey should be considered. If the measured field strength in the location in which this instrument is used exceeds the applicable RF compliance level above, this instrument should be observed to verify normal operation. If abnormal performance is observed, additional measures may be necessary, such as re-orienting or relocating this instrument.
  - <sup>b</sup> Over the frequency range 150 kHz to 80 MHz, field strengths should be less than 3 V/m.



## Recommended Separation Distances Between Portable and Mobile RF Communications Equipment and the EvoEndo® Single-Use Endoscopy System

The EvoEndo® Single-Use Endoscopy System is intended for use in an electromagnetic environment in which radiated RF disturbances are controlled. The customer or the user of the EvoEndo® Single-Use Endoscopy System can help prevent electromagnetic interference by maintaining a minimum distance between portable and mobile RF communications equipment (transmitters) and the EvoEndo® Single-Use Endoscopy System as recommended below, according to the maximum output power of the communications equipment.

Rated maximum output power of transmitter P (W)	Separation distance according to frequency of transmitter (m) (calculated as $V_1=3$ and $E_1=3$ )	
	150 kHz – 80 MHz $d = 3.5\sqrt{P}$	80 MHz – 2.7 GHz $d = 3.5\sqrt{P}$
0.01	0.35	0.35
0.1	1.1	1.1
1	3.5	3.5
10	11	11
100	35	35

NOTES:

- For transmitters rated at a maximum output power not listed above, the recommended separation distance 'd' in meters (m) can be estimated using the equation applicable to the frequency of the transmitter, where 'p' is the maximum output power rating of the transmitter in watts (W) according to the transmitter manufacturer.
- At 80 MHz and 800 MHz, the separation distance for the higher frequency range applies.
- These guidelines may not apply in all situations. Electromagnetic propagation is affected by absorption and reflection from structures, objects, and people.

## Appendix 2. Standards Applied

The EvoEndo® Model LE Single-Use Gastroscope function conforms with:

- IEC 60601-1 Medical electrical equipment – Part 1: General requirements for safety.
- IEC 60601-2-18 Medical electrical equipment – Part 2-18: Particular requirements for the safety of endoscopic equipment.
- ISO 8600-1: Optics and photonics - Medical endoscopes and endotherapy devices - Part 1: General requirements.
- IEC 60601-1-2: Medical electrical equipment – Part 1-2 General requirements for safety – Collateral standard: Electromagnetic compatibility - Requirements for test.
- ISO 594-1: Conical fittings with 6% (Luer) taper for syringes, needles, and certain other medical equipment - Part 1: General requirements.
- ISO 10993-1: Biological Evaluation of Medical Devices - Part 1: Evaluation and testing.

The EvoEndo® EE-C function conforms with:

- Council Directive 93/42/EEC concerning Medical Devices.
- IEC 60601-1 Medical electrical equipment – Part 1: General requirements for safety.
- EN 60601-1-1 Medical electrical equipment – Part 1: General requirements for safety– Collateral standard: Electromagnetic compatibility - Requirements for test.

The EvoEndo® EE-C power supply conforms with:

- Council Directive 93/42/EEC concerning Medical Devices.
- IEC 60601-1 Medical electrical equipment - Part 1: General requirements for safety.
- EN 60601-1-1 Medical electrical equipment - Part 1: General requirements for safety– Collateral standard: Electromagnetic compatibility - Requirements for test.

### **Appendix 3. Warranty and Replacement Program**

The warranty period for the EvoEndo® Controller is three years from delivery to the customer. We agree to replace an EvoEndo® EE-C free of charge if proof can be provided of faulty materials or faulty workmanship. In doing so, we cannot accept the cost of transportation or risk of shipment. There is no warranty on the EvoEndo® Model LE Single-Use Gastroscopy.

Ensure any part of the system being returned is thoroughly disinfected before shipping to EvoEndo®. EvoEndo® reserves the right to return contaminated medical devices to the sender.

THIS PAGE IS INTENTIONALLY BLANK

## Procedure Summary

### Unpack and Inspect

- Device packaging not damaged?
- Device free from defects and not damaged during unpacking?
- Controller cleaned from previous use?

### Connect and Test

- Can make appropriate electrical connections?
- Image quality sufficient?
- Can make appropriate tube/supply connections?
- Successfully ID buttons air/water/suction?
- Air/water/suction functioning correctly?
- Successfully ID buttons freeze image, white-balance, capture image, enhance image?
- Visually checked vertical tip control (thumb lever)?
- Visually checked horizontal tip control (rotary dial)?
- Endoscopic accessories fit the working channel?

### Perform Endoscopic Procedure

### Withdraw, Dispose and Clean

- Remove any endoscopic accessories
- Discard Scope
- Recycle plastic packaging tray
- Clean and disinfect Controller

## Controls Identification

