

SAMSUNG

Product Guide

6.3 cu. ft. Smart Freestanding Electric Range with No-Preheat Air Fry & Convection

NE63A6511

Available in:

Fingerprint Resistant Stainless Steel

Fingerprint Resistant Black Stainless Steel

Black

White



Table of Contents

NE63A6511 - 6.3 cu. ft. Smart Freestanding Electric Range with No-Preheat Air Fry & Convection

Product Overview

Product Overview	4
Carousel Image Order	5

Product Messaging

Features and Benefits	7
Product Videos	11
Fact Tag Guidance	12

Product Specs

Related Products	14
Spec Sheet	15
User Manual and Warranty Information	16

Feature Icons

18

Product Overview

**NE63A6511 – 6.3 cu. ft. Smart Freestanding Electric Range
with No-Preheat Air Fry & Convection**

Product Overview

Product Title

6.3 cu. ft. Smart Freestanding Electric Range with No-Preheat Air Fry & Convection

Product Short Description (86 characters)

Elevate the look of your kitchen with Samsung's new Smart Freestanding Electric Range.

Product Long Description (239 characters)

Elevate the look of your kitchen with Samsung's new Smart Freestanding Electric Range. Our Stainless Steel design elegantly wraps around cooktop sides and up through the slim control panel. Upgraded technology makes cooking simple and fun.

Available Colors



**Fingerprint Resistant
Stainless Steel**
NE63A6511SS



**Fingerprint Resistant
Black Stainless Steel**
NE63A6511SG



Black
NE63A6511SB



White
NE63A6511SW



Carousel Image Order



Easy Ad Links: NE63A6511SS

R.COM <https://dam.gettyimages.com/p/z0c3461/external?q=NE63A6511SS%20Carousel%20RCOM>

S.COM <https://dam.gettyimages.com/p/z0c3461/external?q=NE63A6511SS%20Carousel%20SCOM>

360 Spin <https://dam.gettyimages.com/p/z0c3461/external?q=NE63A6511SS%20360>

Easy Ad Links: NE63A6511SG

R.COM <https://dam.gettyimages.com/p/z0c3461/external?q=NE63A6511SG%20Carousel%20RCOM>

S.COM <https://dam.gettyimages.com/p/z0c3461/external?q=NE63A6511SG%20Carousel%20SCOM>

360 Spin <https://dam.gettyimages.com/p/z0c3461/external?q=NE63A6711SG%20spin>

Easy Ad Links: NE63A6511SB

R.COM <https://dam.gettyimages.com/p/z0c3461/external?o=AND&q=NE63A6511SB%20Carousel%20RCOM>

S.COM <https://dam.gettyimages.com/p/z0c3461/external?o=AND&q=NE63A6511SB%20Carousel%20SCOM>

Easy Ad Links: NE63A6511SW



R.COM <https://dam.gettyimages.com/p/z0c3461/external?o=AND&q=NE63A6511SW%20Carousel%20RCOM>

S.COM <https://dam.gettyimages.com/p/z0c3461/external?o=AND&q=NE63A6511SW%20Carousel%20SCOM>



Product Messaging

**NE63A6511 – 6.3 cu. ft. Smart Freestanding Electric Range
with No-Preheat Air Fry & Convection**



Features and Benefits – NE63A6511

Overall Product Headline	Feature Name	Long Body Copy	Short Body Copy	Associated Image
<p>Elevated Design</p>	<p>Stainless Steel Design</p>	<p>Our Stainless Steel design elegantly wraps around the cooktop sides and up through the slim control panel, elevating the look of any kitchen. Ergonomic knobs are easy to grip comfortably for precise temperature control. If that’s not enough, tinted glass on the oven door gives your range the upgrade you deserve.</p>	<p>Our Stainless Steel design elegantly wraps around the cooktop sides and up through the slim control panel, elevating the look of any kitchen.</p>	
<p>No-Preheat Air Fry - Healthier cooking with a crunch*</p> <p><small>*As compared to deep-frying.</small></p>	<p>Air Fry</p>	<p>Cooking with a crunch just got healthier with Air Fry.* Using little to no oil, you can quickly prepare your favorite fried foods right in your oven. No preheating required.</p> <p><small>*As compared to deep-frying. Air Fry tray sold separately.</small></p>	<p>A healthier way to prepare your favorite fried foods right in your oven with little to no oil.* No preheating required.</p> <p><small>*As compared to deep-frying. Air Fry tray sold separately.</small></p>	 <p><small>Air Fry tray sold separately.</small></p>
<p>Make cooking simple with smart technology</p>	<p>Wi-Fi and Voice Enabled</p>	<p>Preheat, adjust time and temperature of your oven, and monitor your cooktop from wherever you are with your smartphone.* Conveniently use voice to control your oven whether it’s Alexa, Bixby or Google.**</p> <p><small>*Available on Android or IOS devices. A Wi-Fi connection and a Samsung account are required.</small></p> <p><small>** Bixby is Samsung's brand of artificial intelligence (AI)/Internet of Things (IOT) voice assistant. All voice commands are available on Android and IOS.</small></p>	<p>Preheat, monitor and adjust time and temperature of your oven from wherever you are using your smartphone.*</p> <p><small>*Available on Android or IOS devices. A Wi-Fi connection and a Samsung account are required.</small></p>	 <p><small>Bixby works with Google Assistant</small></p>



Features and Benefits – NE63A6511 (Continued)

Overall Product Headline	Feature Name	Long Body Copy	Short Body Copy	Associated Image
<p>Save time with convection</p>	<p>Convection</p>	<p>Powerful convection saves you time by cooking food fast and more evenly. Fan circulates hot air in the oven for perfect baking and roasting.</p>	<p>Powerful convection saves you time by cooking food fast and more evenly.</p>	
<p>Cook enough for the whole crew</p>	<p>Large Oven Capacity</p>	<p>This large 6.3 cu. ft. oven can fit multiple dishes at one time and can easily accommodate big casserole dishes and large roasting pans.</p>	<p>This large 6.3 cu. ft. oven can fit multiple dishes at one time.</p>	
<p>Boil Fast</p>	<p>Rapid Boil™</p>	<p>Boil water for your favorite pasta dish fast with the 3300 W Rapid Boil™ burner.</p>	<p>Boil water fast with the 3300 W Rapid Boil™ burner.</p>	 <p>Note: GIF and static assets available (GIF is preferred).</p>

Features and Benefits – NE63A6511 (Continued)

Overall Product Headline	Feature Name	Long Body Copy	Short Body Copy	Associated Image
<p>All shine</p>	<p>Fingerprint Resistant Finish</p>	<p>Fingerprint resistant for an everyday beautiful finish.</p>	<p>Fingerprint resistant, beautiful finish.</p>	 <p>Fingerprint resistant</p> <p>Note: Image should be customized by finish color for the respective model.</p>
<p>A cooktop that gets it all done!</p>	<p>Flexible 5-Burner Cooktop</p>	<p>This 5-burner cooktop includes adjustable medium and large dual ring burners so you can cook with a variety of pot and pan sizes.</p>	<p>This 5-burner cooktop includes adjustable medium and large dual ring burners.</p>	
<p>Cooking simplified with easy preset buttons</p>	<p>Bread Proof, Dehydrate, Keep Warm and Favorite Cook Settings</p>	<p>Prepare a variety of foods with the aid of easy preset buttons. With a simple push of a button, you can proof bread, dehydrate your favorite jerky and keep meals warm in the oven with precision. And if you have a favorite recipe, conveniently save the settings in the SmartThings mobile app and send them to your oven.*</p> <p><small>*Available on Android or IOS devices. A Wi-Fi connection and a Samsung account are required.</small></p>	<p>Prepare foods with the aid of easy preset buttons. Four preset buttons include: Bread Proof, Dehydrate, Keep Warm and Favorite Cook.</p>	

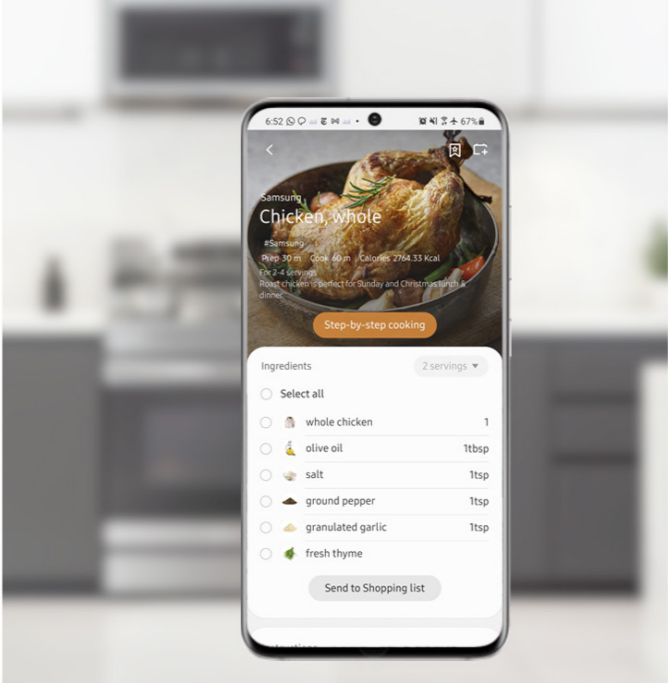
Features and Benefits – NE63A6511 (Continued)

Overall Product Headline	Feature Name	Long Body Copy	Short Body Copy	Associated Image
<p>Cooking with a personalized touch</p>	<p>SmartThings Cooking</p>	<p>Samsung’s SmartThings Cooking service* makes meal planning a seamless process. Search, plan, purchase and prep weekly meals via the SmartThings app on your Family Hub™ or smartphone. SmartThings Cooking recommends personalized recipes based on preferences, what’s on hand and recipe search history so you can plan meals for your family more efficiently. Download the SmartThings app to create shopping lists and add missing ingredients directly to your grocery cart for at-home delivery.</p> <p><small>*Available on Android or IOS devices. A Wi-Fi connection and a Samsung account are required.</small></p>	<p>Search recipes, plan meals, and add any missing ingredients to your grocery cart for at-home delivery with SmartThings Cooking.*</p> <p><small>*Available on Android or IOS devices. A Wi-Fi connection and a Samsung account are required.</small></p>	
<p>Spend less time cleaning</p>	<p>Self & Steam Clean</p>	<p>Keep your oven spotless with Self and Steam Clean. Self Clean deep cleans by heating to a high temperature to burn off grease and food residue. For easier cleanup in 20 minutes, use Steam Clean.</p>	<p>Keep your oven spotless with the Self and Steam Clean.</p>	 <p style="text-align: center;">Self Clean Steam Clean</p>

Product Videos

Easy Ads link

<https://dam.gettyimages.com/s/rs98hrbm6fgtpbbvphnxm63m>

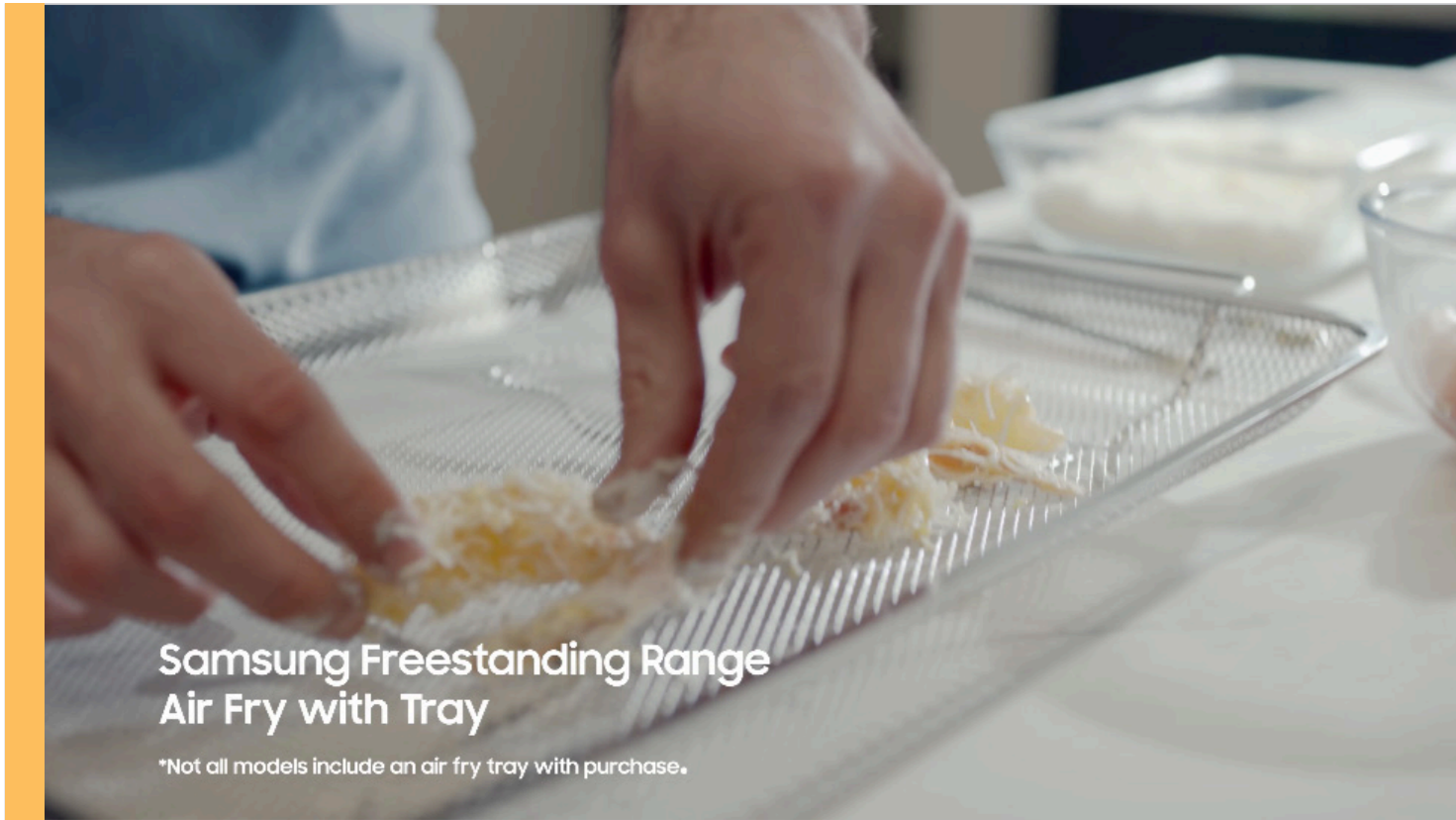

Air Fry

Easy Ads link

<https://dam.gettyimages.com/s/fnfbwwtw4hsk5m8998zcv>



Large Oven Capacity

Easy Ads link

<https://dam.gettyimages.com/s/kfrnfmhrspwschxs8jrw8v>



Flexible Cooktop with Griddle

Easy Ads link

<https://dam.gettyimages.com/s/kcwx37rn4f6z2sc9rmpbbwqw>



SmartThings Cooking

Easy Ads link

<https://dam.gettyimages.com/s/jb6vbvhsvk5fqf2mrt88w>

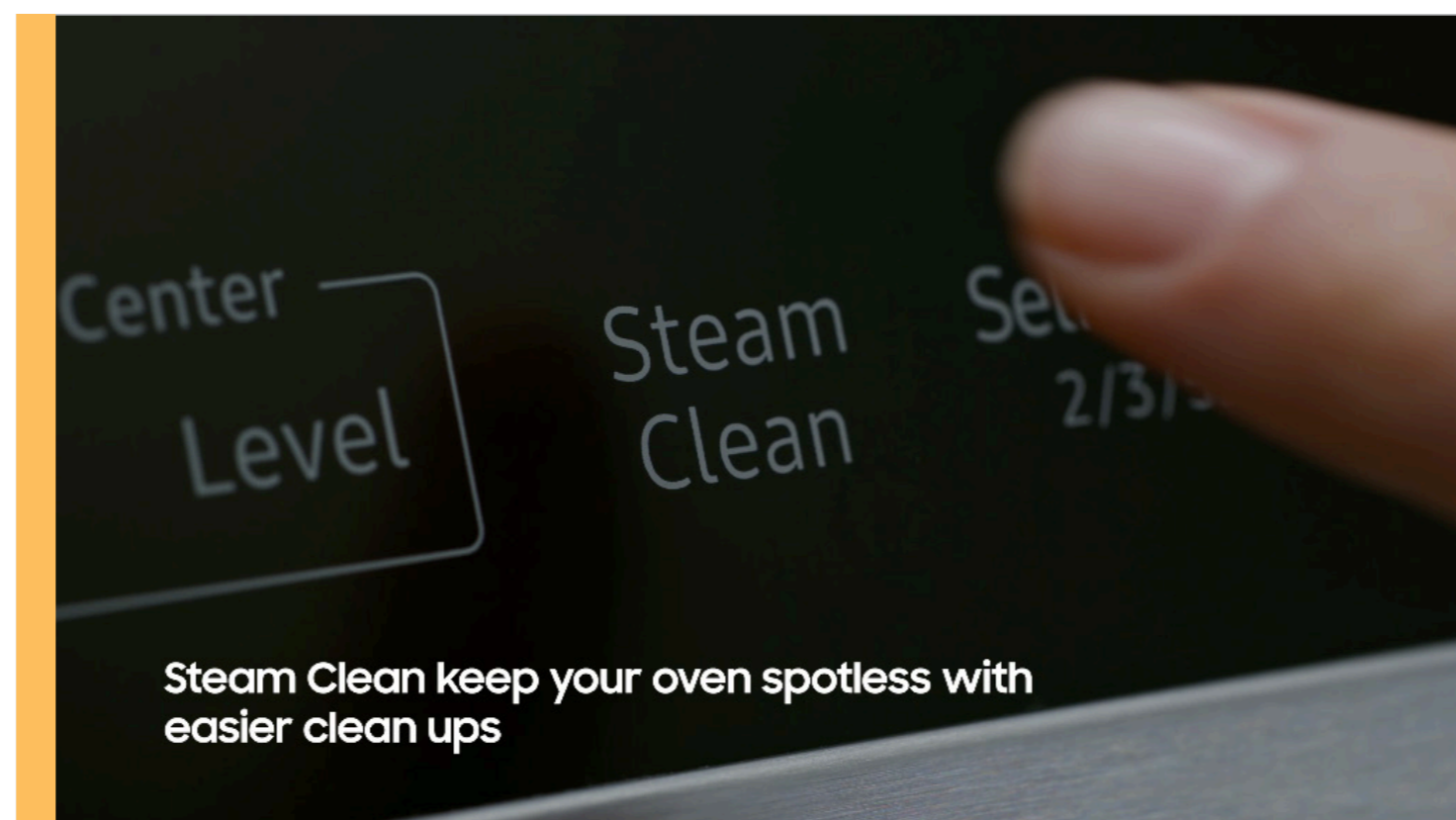

Easy to Clean

Fact Tag Guidance

Please follow one of the below naming conventions for fact tags at retail, accounting for any potential character count limitations. Please also ensure that any feature list appearing on fact tags follows the Product Messaging hierarchy and copy noted in the Product Guide for each model.

NE63A6511

Long (More than 40 Characters)

6.3 cu. ft. Smart Freestanding Electric Range with No-Preheat Air Fry & Convection (82 characters)

Medium (40 Characters or less)

6.3 cu. ft. Smart Freestanding Range (36 characters)

Short (30 Characters or less)

6.3 cu. ft. Freestanding Range (30 characters)



Product Specs

**NE63A6511 – 6.3 cu. ft. Smart Freestanding Electric Range
with No-Preheat Air Fry & Convection**

Related Products

COLOR	PRODUCT	MODEL
Black Stainless Steel	OTR	ME21R7051SG
	OTR	ME19R7041FG
	DISH	DW80R5061UG
	REF	RF27T5201SG

Stainless Steel	HOOD	ME21R7051SS
	OTR	ME19R7041FS
	DISH	DW80R5061US
	REF	RF27T5201SR

Black	OTR	ME19R7041FB
	OTR	ME17R7021EB
	DISH	DW80N3030UB

White	OTR	ME19R7041FW
	OTR	ME17R7021EW
	DISH	DW80N3030UW
	REF	RF27T5201WW

ACCESSORY	MODEL
AIR FRY TRAY	NX-AA5000RS

Spec Sheet

Easy Ads link

<https://dam.gettyimages.com/p/z0c3461/external?q=NE63A6511SS%20Spec%20Sheet%20>

NE63A6511SS

Samsung Smart Freestanding Electric Range with No Pre-heat Air Fry & Convection

6.3 cu. ft. Capacity



Signature Features

Air Fry

- A healthier way to prepare your favorite fried foods right in your oven with little to no oil.* No preheating required.

*As compared to deep frying. Air Fry tray sold separately.

Convection

- Powerful convection saves you time by cooking food fast and more evenly.

Large Oven Capacity

- This large 6.3 cu. ft. oven can fit multiple dishes at one time.

Available Colors

- Fingerprint Resistant Stainless Steel (shown)
- Fingerprint Resistant Black Stainless Steel
- Black
- White



Air Fry



Convection

Features

- Stainless Steel Design
- Air Fry – Tray Not Included
- Convection
- Large Oven Capacity – 6.3 cu. ft.
- Rapid Boil™ 3300 W
- Extra Oven Settings - Bread Proof, Dehydrate, Favorite Cook, Keep Warm
- Storage Drawer

Convenience

- Wi-Fi Connectivity
- Voice-Enabled
- SmartThings Cooking
- Convection Auto Conversion
- Self & Steam Clean
- Hidden Bake Element
- Sabbath Mode
- Child Safety Lock
- Delay Start
- Auto Oven Light
- Kitchen Timer

SAMSUNG

NE63A6511SS

Samsung Smart Freestanding Electric Range with No Pre-heat Air Fry & Convection

6.3 cu. ft. Capacity

Installation Specifications

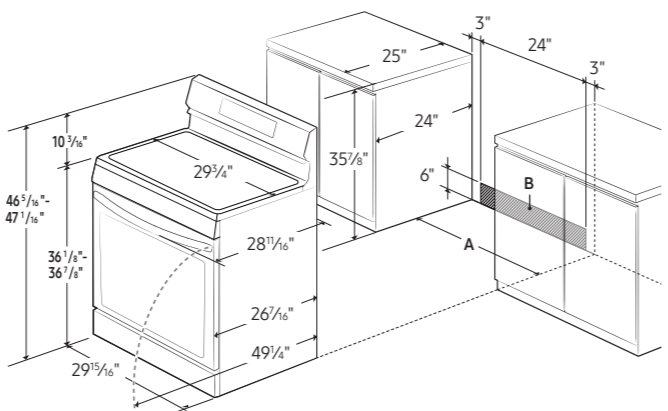

A: Cabinet opening min 30"
B: Acceptable electrical outlet area

IMPORTANT: If your cabinets are over 36 1/4" high, you must install this range on a hard, heat-resistant support that raises the surface of the range so that it is about even with the countertop.

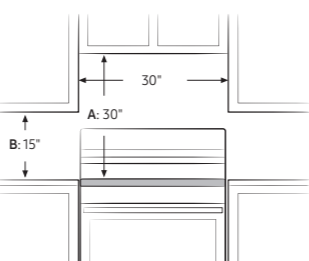

A: 30" minimum clearance between the top of the cooking surface and the bottom of an unprotected wood or metal cabinet; or 24" minimum when the bottom of the wood or metal cabinet is protected by not less than 1/4" of flame retardant millboard covered with not less than no.28 MSG sheet steel, 0.015" stainless steel, 0.024" aluminum, or 0.020" copper.

B: 15" minimum between the countertop and the adjacent cabinet bottom.

IMPORTANT: Consult with Installation Manual for detailed instructions before installing. All ranges must be installed with the Anti-Tip device that is included.

SAMSUNG

Power Source
240V/208V/60 Hz/40A

Electric Cooktop

- Right Front: 9"/12" Dual Ring Burner, 3000 W
- Left Front: 6"/9" Dual Ring Burner, 3300 W
- Right Rear: 6" Burner, 1200 W
- Left Rear: 6" Burner, 1200 W
- Center: Warming Center, 100 W

Oven

- Capacity: 6.3 cu. ft.
- Convection Element/Heater
- Convection Bake
- Convection Roast
- Bake
- Variable Broil: Low/High
- Air Fry
- Bread Proof
- Dehydrate

Warranty
One (1) Year Parts and Labor

Product Dimensions & Weight (WxHxD)
Oven Interior Dimensions:
24 1/16" x 22 7/16" x 19 3/4"
Outside Net Dimensions:
29 1/16" x 46 1/16" - 47 1/16" (Adjustable) x 28 1/16"
Weight: 148 lbs

Shipping Dimensions & Weight (WxHxD)
Dimensions:
33 1/16" x 50 1/16" x 30 5/16"
Weight: 172 lbs

Color	Model #	UPC Code
Fingerprint Resistant Stainless Steel	NE63A6511SS	887276509426
Fingerprint Resistant Black Stainless Steel	NE63A6511SG	887276509419
Black	NE63A6511SB	887276509402
White	NE63A6511SW	887276509440

Actual color may vary. Design, specifications, and color availability are subject to change without notice. Non-metric weights and measurements are approximate.
©2021 Samsung Electronics America, Inc. 85 Challenger Road, Ridgefield Park, NJ 07066. Tel. 800-SAMSUNG. samsung.com. Samsung is a registered trademark of Samsung Electronics Co. Ltd.

Spec Sheet - front

Spec Sheet - back

User Manual and Warranty Information

Easy Ads link

<https://dam.gettyimages.com/p/z0c3461/external?q=NE63A6511%20User%20Manual>

<https://dam.gettyimages.com/p/z0c3461/external?q=NE63A%20warranty>



Electric Range

User manual

NE63*651*S*

User Manual

Warranty (U.S.A) – SAMSUNG ELECTRIC RANGE

Models:
NE63A6111/AA
NE63A6311/AA
NE63A6511/AA
NE63A6711/AA

LIMITED WARRANTY TO ORIGINAL PURCHASER WITH PROOF OF PURCHASE

This SAMSUNG brand product, as supplied and distributed by SAMSUNG ELECTRONICS AMERICA, INC. (SAMSUNG) and delivered new, in the original carton to the original consumer purchaser, is warranted by SAMSUNG against manufacturing defects in materials or workmanship for the limited warranty period, starting from the date of original purchase, of:

One (1) Year Parts and Labor

This limited warranty is valid only on products purchased and used in the United States that have been installed, operated, and maintained according to the instructions attached to or furnished with the product. To receive warranty service, the purchaser must contact SAMSUNG at the address or phone number provided below for problem determination and service procedures. Warranty service can only be performed by a SAMSUNG authorized service center. The original dated bill of sale must be presented upon request as proof of purchase to SAMSUNG or SAMSUNG's authorized service center to receive warranty service.

SAMSUNG will provide in-home service within the contiguous United States during the warranty period at no charge, subject to availability of SAMSUNG authorized servicers within the customer's geographic area. If in-home service is not available, SAMSUNG may elect, at its option, to provide transportation of the product to and from an authorized service center. If the product is located in an area where service by a SAMSUNG authorized servicer is not available, you may be responsible for a trip charge or required to bring the product to a SAMSUNG authorized service center for service.

To receive in-home service, product must be unobstructed and accessible to the service agent.

During the applicable warranty period, a product will be repaired, replaced, or the purchase price refunded, at the sole option of SAMSUNG. SAMSUNG may use new or reconditioned parts in repairing a product, or replace the product with a new or reconditioned product. Replacement parts and products are warranted for the remaining portion of the original product's warranty or ninety (90) days, whichever is longer. All replaced parts and products are the property of SAMSUNG and you must return them to SAMSUNG.

This limited warranty covers manufacturing defects in materials or workmanship encountered in normal household, noncommercial use of this product and shall not cover the following: damage that occurs in shipment, delivery, installation, and uses for which this product was not intended; damage caused by unauthorized modification or alteration of the product; product where the original factory serial numbers have been removed, defaced, changed in any way, or cannot

Warranty

Feature Icons

**NE63A6511 – 6.3 cu. ft. Smart Freestanding Electric Range
with No-Preheat Air Fry & Convection**

Feature Icons

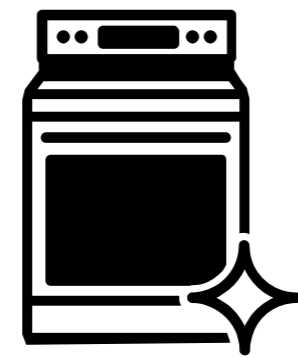

Elevated Design



Air Fry

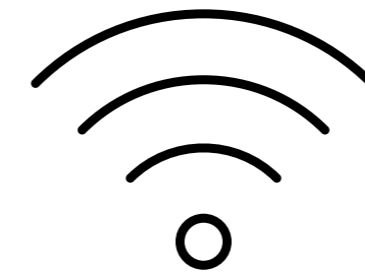

Wi-Fi Connectivity

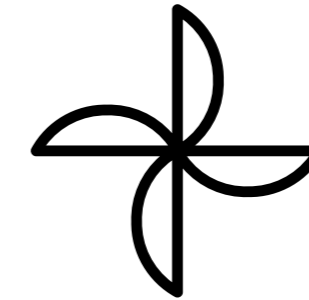

Convection

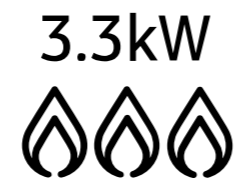

Rapid Boil™



Fingerprint Resistant Finish



Self & Steam Clean

SAMSUNG