

SAMSUNG

Product Guide

7300 Series Laundry

Available in Ivory



Table of Contents

WA55A7300AE - Top Load Washer

Product Overview

Product Overview 4

Carousel Image Order 5

Product Messaging

Features and Benefits 7

Product Specs

Related Products 14

Spec Sheet 15

Energy Guide 16

User Manual and Warranty 17

Feature Icons 19

DVE55A7300E - Electric Dryer

DVG55A7300E - Gas Dryer

Product Overview

Product Overview 21

Carousel Image Order 22

Product Messaging

Features and Benefits 24

Product Specs

Related Products and Accessories 29

Spec Sheets 30

User Manual and Warranty 31

Feature Icons 33

Product Overview

WA55A7300AE

**5.5 cu. ft. Extra-Large Capacity Smart Top Load Washer
with Super Speed Wash**

Product Overview

Product Title

5.5 cu. ft. Extra-Large Capacity Smart Top Load Washer with Super Speed Wash

Product Short Description (287 Characters)

Samsung's new Top Load Washer has a 5.5 cu. ft. Extra-Large Capacity so you can fit more in every load, it can wash a full load of laundry with full performance in just 28 minutes,* and it's Wi-Fi connected so you can receive end of cycle alerts and schedule laundry from your smartphone.**

Product Long Description (372 Characters)

Samsung's new 5.5 cu. ft. Extra-Large Capacity Smart Top Load Washer helps you fit more in every load and cut down on laundry time. Also, with Super Speed Wash, you can wash a full load of laundry with full performance in just 28 minutes.* With integrated Wi-Fi, you can receive end of cycle alerts and remotely start, stop, and schedule laundry right from your smartphone.**

*Based on using Super Speed on a Normal cycle with an 8lb load.

**Requires wireless network, Samsung account and SmartThings App. The Samsung SmartThings App supports Android OS 4.0 (ICS) or later which is optimized for Samsung smartphones (Galaxy S and Galaxy Note series). This app also supports iOS 7 or later for iPhone models. Samsung SmartThings App available in App Store and Play Store.

Available Color

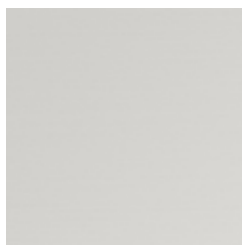

Ivory

Model Number: WA55A7300AE

UPC: 887276552903

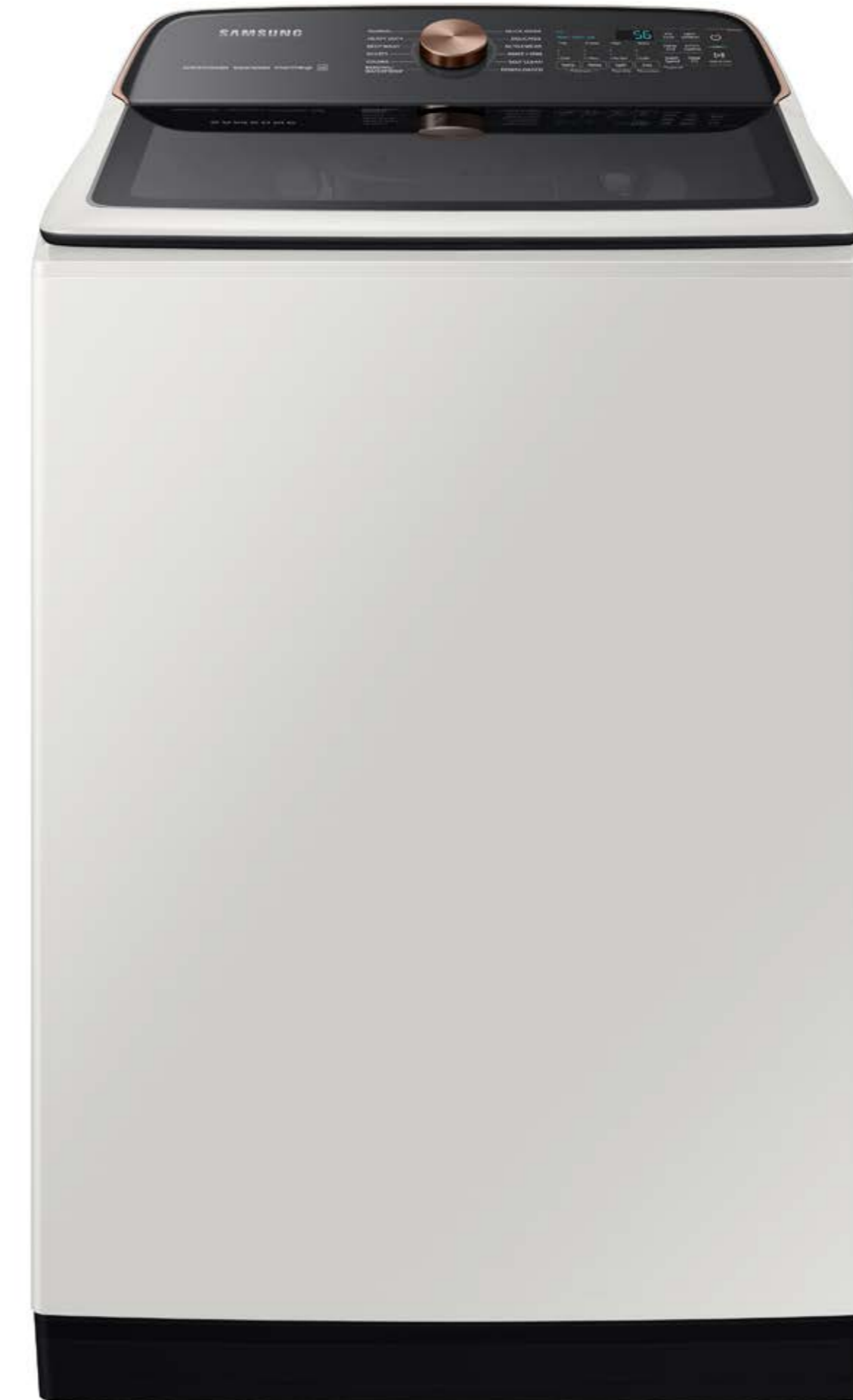

Carousel Image Order

Easy Ads links

Retail.com: <https://dam.gettyimages.com/p/z0c3461/external?o=AND&q=WA55A7300AE%20Carousel%20Images%20RCOM>
Samsung.com: <https://dam.gettyimages.com/p/z0c3461/external?o=AND&q=WA55A7300AE%20Carousel%20Images%20SCOM>
360 Spin: <https://dam.gettyimages.com/p/z0c3461/external?o=AND&q=WA55A7300AE%20360%20Spins>

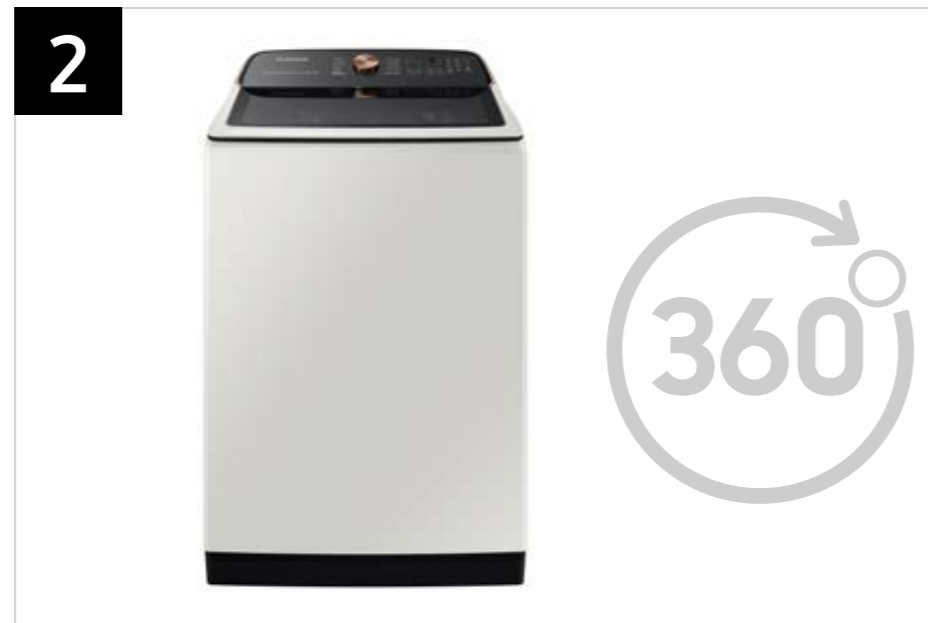



Product Messaging

WA55A7300AE

**5.5 cu. ft. Extra-Large Capacity Smart Top Load Washer
with Super Speed Wash**



Features and Benefits: WA55A7300AE

Ivory Washer Easy Ads link: <https://dam.gettyimages.com/p/z0c3461/external?o=AND&q=WA55A7300AE%20Below%20The%20Fold>

Headline	Feature Name	Long Body Copy	Short Body Copy	Associated Image
<p>The New, Improved White</p>	<p>Ivory Finish</p>	<p>Samsung's new premium ivory finish marries a timeless color with a sophisticated design, never before seen in laundry. Ivory is the latest offering in a palette of colors perfect to complement today's design trends.</p>	<p>Samsung's new premium ivory finish marries a timeless color with a sophisticated design, never before seen in laundry.</p>	
<p>Fit more for fewer loads</p>	<p>Extra-Large 5.5 cu. ft. Capacity</p>	<p>Fewer loads, less time in the laundry room, and more time doing the things you love.</p>	<p>Fewer loads, less time in the laundry room.</p>	
<p>Wash a full load in 28 minutes</p>	<p>Super Speed Wash</p>	<p>Wash a full load of laundry in just 28 minutes,* without sacrificing cleaning performance. *Based on using Super Speed on a Normal cycle with an 8lb load.</p>	<p>Fast, thorough washing in just 28 minutes.* *Based on using Super Speed on a Normal cycle with an 8lb load.</p>	



Features and Benefits: WA55A7300AE (Continued)

Ivory Washer Easy Ads link: <https://dam.gettyimages.com/p/z0c3461/external?o=AND&q=WA55A7300AE%20Below%20The%20Fold>

Headline	Feature Name	Long Body Copy	Short Body Copy	Associated Image
<p>Control in the palm of your hand</p>	<p>Wi-Fi Connectivity</p>	<p>Wi-Fi connected so you can receive end of cycle alerts, remotely start or stop your wash, schedule cycles on your time, and more, right from your smartphone with the SmartThings App.*</p> <p><small>*Requires wireless network, Samsung account and SmartThings App. The Samsung SmartThings App supports Android OS 4.0 (ICS) or later which is optimized for Samsung smartphones (Galaxy S and Galaxy Note series). This app also supports iOS 7 or later for iPhone models. SmartThings App available in App Store and Play Store.</small></p>	<p>Receive end of cycle alerts, remotely start, schedule, and more, from your smartphone with the SmartThings App.*</p> <p><small>*Requires wireless network, Samsung account and SmartThings App. The Samsung SmartThings App supports Android OS 4.0 (ICS) or later which is optimized for Samsung smartphones (Galaxy S and Galaxy Note series). This app also supports iOS 7 or later for iPhone models. SmartThings App available in App Store and Play Store.</small></p>	
<p>Pretreat with a push of a button</p>	<p>Active WaterJet</p>	<p>A built-in water faucet lets you easily pretreat soiled or heavily stained clothes with a press of a button. Scrub items right inside your washer, no laundry room sink needed.</p>	<p>Built-in water faucet lets you easily pretreat heavily soiled and stained clothes.</p>	
<p>More water when you need it most</p>	<p>Deep Fill</p>	<p>Maximize the water level used during your washing cycle by selecting the Deep Fill option* before starting your laundry. Deep Fill automatically adds extra water at the right time to ensure that all your items are thoroughly soaked.</p> <p><small>*Not available for use in the Bedding/Waterproof and Self Clean cycles.</small></p>	<p>Choose to maximize the water level used during the washing cycle.*</p> <p><small>*Not available for use in the Bedding/Waterproof and Self Clean cycles.</small></p>	



Features and Benefits: WA55A7300AE (Continued)

Ivory Washer Easy Ads link: <https://dam.gettyimages.com/p/z0c3461/external?o=AND&q=WA55A7300AE%20Below%20The%20Fold>

Headline	Feature Name	Long Body Copy	Short Body Copy	Associated Image
<p>Easy to troubleshoot</p>	<p>Smart Care</p>	<p>Easy troubleshooting from the convenience of your smartphone.* Smart Care interacts with your washer and dryer to perform an immediate diagnosis and offer quick solutions.</p> <p>*Requires Samsung Smart Washer/Dryer App. The Samsung Smart Washer/Dryer App supports Android OS 2.3.6 or later and iOS 3 or later for iPhone models. Samsung Smart Washer/Dryer App available in App Store and Play Store.</p>	<p>Easy troubleshooting from the convenience of your smartphone.*</p> <p>*Requires Samsung Smart Washer/Dryer App. The Samsung Smart Washer/Dryer App supports Android OS 2.3.6 or later and iOS 3 or later for iPhone models. Samsung Smart Washer/Dryer App available in App Store and Play Store.</p>	
<p>Purchase with confidence</p>	<p>20-Year Motor Warranty</p>	<p>Purchase with confidence any Samsung Washer model with a Digital Inverter Motor and receive a 20 year warranty on the motor.*</p> <p>*20-year warranty limited to the Digital Inverter Motor of washers purchased on 7/1/2022 or later. Purchase receipt indicating purchase date required for a claim. Additional restrictions and limitations apply, see warranty for details.</p>	<p>Purchase with confidence any Samsung Washer model with a Digital Inverter Motor and receive a 20 year warranty on the motor.*</p> <p>*20-year warranty limited to the Digital Inverter Motor of washers purchased on 7/1/2022 or later. Purchase receipt indicating purchase date required for a claim. Additional restrictions and limitations apply, see warranty for details.</p>	
<p>Quiet washing anytime, any place</p>	<p>Vibration Reduction Technology+</p>	<p>Do your laundry without disturbing anyone at any time and in any place. Innovative Vibration Reduction Technology+ reduces noise and vibration for quiet washing.</p>	<p>Reduces noise and vibration for quiet washing.</p>	



Features and Benefits: WA55A7300AE (Continued)

Ivory Washer Easy Ads link: <https://dam.gettyimages.com/p/z0c3461/external?o=AND&q=WA55A7300AE%20Below%20The%20Fold>

Headline	Feature Name	Long Body Copy	Short Body Copy	Associated Image
N/A	Swirl+ Tub Interior	Improved tub pattern extracts more water more quickly during the rinsing cycle and prevents fabrics from snagging during washing.	Improved tub pattern extracts more water more quickly.	
Keep your washer fresh and clean	Self Clean	Keep your washer tub fresh and clean. Self Clean will notify you every 20 wash cycles when it is time for a cleaning.	Keep your washer tub fresh and clean.	
N/A	Soft-Close Lid	The premium Soft-Close Lid keeps you and your family protected by closing safely, gently and quietly.	Soft-Close Lid closes safely, gently and quietly.	

Features and Benefits: WA55A7300AE (Continued)

Ivory Washer Easy Ads link: <https://dam.gettyimages.com/p/z0c3461/external?o=AND&q=WA55A7300AE%20Below%20The%20Fold>

Headline	Feature Name	Long Body Copy	Short Body Copy	Associated Image
N/A	ENERGY STAR® Certified	<p>ENERGY STAR® Certified,* so you can save money by using less energy without sacrificing performance or functionality.</p> <p><small>*Visit www.energystar.gov for more information on ENERGY STAR® guidelines.</small></p>	Eco-friendly and energy-efficient.	
N/A	Stainless Steel Pulsator	Premium material and design that is more durable and scratch resistant.	More durable and scratch resistant.	
Easier use, for everyone	Accessibility (AUI, Braille)	Aiding the visually and hearing impaired, your washer and dryer now features audio assistance, playing a different sound for each option, and braille right next to key control panel buttons.	Designed for easy use for everyone.	

Features and Benefits: WA55A7300AE (Continued)

Ivory Washer Easy Ads link: <https://dam.gettyimages.com/p/z0c3461/external?o=AND&q=WA55A7300AE%20Below%20The%20Fold>

Headline	Feature Name	Long Body Copy	Short Body Copy	Associated Image
N/A	12 Preset Washing Cycles	More cycles to cover almost every washing need for your active family.	More cycles to best suit your washing needs.	

Product Specs

WA55A7300AE

**5.5 cu. ft. Extra-Large Capacity Smart Top Load Washer
with Super Speed Wash**

Related Products

Dryer Series

DVE55A7300E
DVG55A7300E

Spec Sheet

Easy Ads link

<https://dam.gettyimages.com/p/z0c3461/external?o=AND&q=WA55A7300AE%20Spec%20Sheet>

WA55A7300AE
Samsung 5.5 cu. ft. Extra-Large Capacity Smart Top Load Washer with Super Speed Wash



Available Color
Ivory
WA55A7300AE

Features

- Extra-Large 5.5 cu. ft. Capacity
- Super Speed Wash
- Wi-Fi Connectivity*
- Active WaterJet
- Deep Fill
- Smart Care
- Vibration Reduction Technology+
- Swirl+ Tub Interior
- Self Clean
- Soft-Close Lid
- ENERGY STAR® Certified
- Stainless Steel Pulsator
- Accessibility (AUI, Braille)
- 750 RPM Maximum Spin Speed
- Direct Drive Motor
- 17 Total Washing Cycles
- 10 Additional Washing Options

Specifications

12 Preset Washing Cycles: Normal, Bedding/Waterproof, Heavy Duty, Colors, Whites, Activewear, Delicates, Quick Wash, Self Clean, Rinse + Spin, Deep Wash, Downloaded

5 Downloadable Washing Cycles: Permanent Press, Wool, Eco Cold, Denim, Power Rinse

10 Additional Washing Options: Delay End, Presoak, Sound On/Off, Child Lock, Fabric Softener, Deep Fill, Super Speed, Smart Care, Smart Control, Spin Only

5 Temperature Settings: Hot, Warmer, Warm, Cool, Cold

5 Spin Settings: High, Medium High, Medium, Low, No Spin

Convenience

- Child Lock
- Dispenser Trays: Main Wash, Softener, Bleach

Ratings

ENERGY STAR® Rated:
IMEF = 2.06
IWF = 4.3
120 kWh/yr

Electrical Requirements
120 V / 60 Hz
15 Amps

Washer	Model #	UPC Code
Ivory	WA55A7300AE	88727651221
Matching Electric Dryer		
Ivory	DVE55A7300E	88727651609
Matching Gas Dryer		
Ivory	DVG55A7300E	887276557823

SAMSUNG

*Requires wireless network, Samsung account and Samsung SmartThings App. The Samsung Smart Things App supports Android OS 4.0 (ICS) or later which is optimized for Samsung smartphones (Galaxy S and Galaxy Note series). This app also supports iOS 7 or later for iPhone models. Samsung SmartThings App available in App Store and Play Store.

Washer Spec Sheet - page 1

WA55A7300AE
Samsung 5.5 cu. ft. Extra-Large Capacity Smart Top Load Washer with Super Speed Wash

Dimensions
Required dimensions for installation:

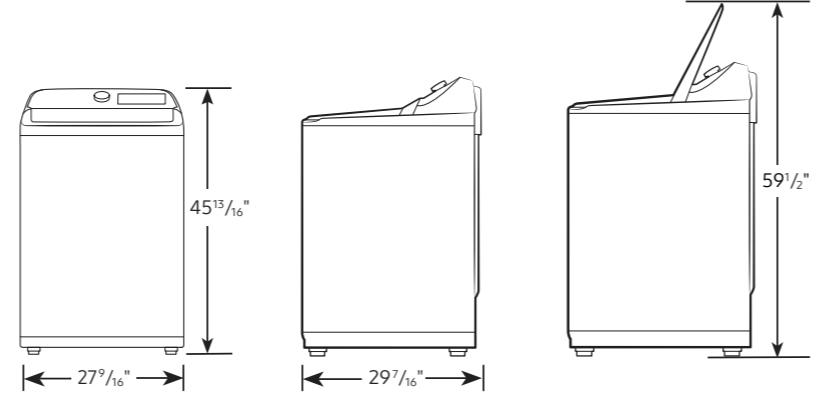

Installation Specifications – Side-by-Side
If the washer and dryer are installed together or the dryer alone, the closet front must have two unobstructed air openings for a combined minimum total area of 72-inch². Your washer alone does not require a specific air opening.

Alcove or closet installation
Minimum clearance for alcove and alcove installations:

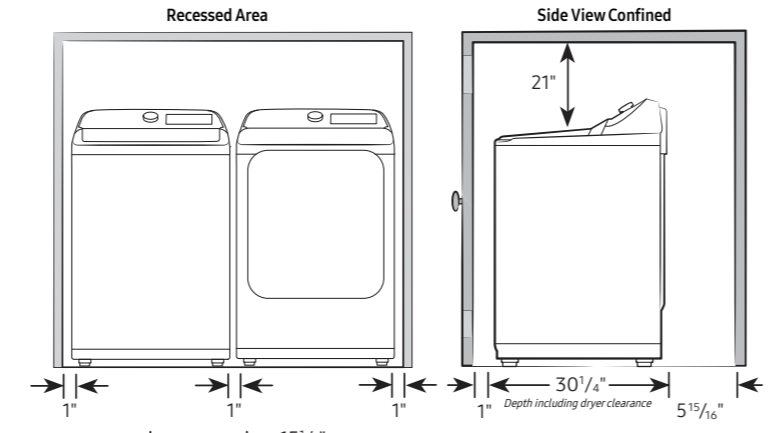

Connection Dimensions
Back view of washer

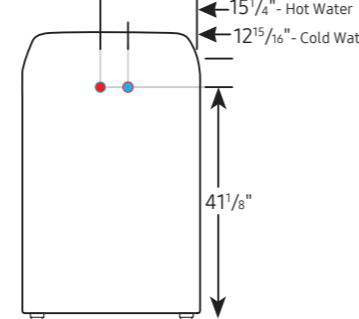

LEGEND:
● Hot Water Connection
● Cold Water Connection

Actual color may vary. Design, specifications, and color availability are subject to change without notice. Non-metric weights and measurements are approximate.
©2021 Samsung Electronics America, Inc.
35 Challenger Road, Bldg 904 Park, NJ 07650.
Tel: 800-SAMSUNG, samsung.com, Samsung is a registered trademark of Samsung Electronics Co., Ltd.

SAMSUNG

Washer Spec Sheet - page 2

Energy Guide

Easy Ads link

<https://dam.gettyimages.com/p/z0c3461/external?o=AND&q=WA55A7300AE%20Energy%20Guide>

U.S. Government Federal law prohibits removal of this label before consumer purchase.

ENERGYGUIDE

Clothes Washer Capacity Class: Standard Samsung Models WA55A73**A* Capacity (tub volume): 5.5 cubic feet

Compare ONLY to other labels with yellow numbers.
Labels with yellow numbers are based on the same test procedures.

Estimated Yearly Energy Cost
(when used with an electric water heater)

\$14

\$8 Cost Range of Similar Models \$51

120 kWh
Estimated Yearly Electricity Use

\$9
Estimated Yearly Energy Cost
(when used with a natural gas water heater)

- Your cost will depend on your utility rates and use.
- Cost range based only on standard capacity models.
- Estimated energy cost based on six wash loads a week and a national average electricity cost of 12 cents per kWh and natural gas cost of \$1.09 per therm.

ftc.gov/energy



DC68-03852F-00

Energy Guide

User Manual and Warranty

Easy Ads link

<https://dam.gettyimages.com/p/z0c3461/external?o=AND&q=WA55A7300AE%20User%20Manual>

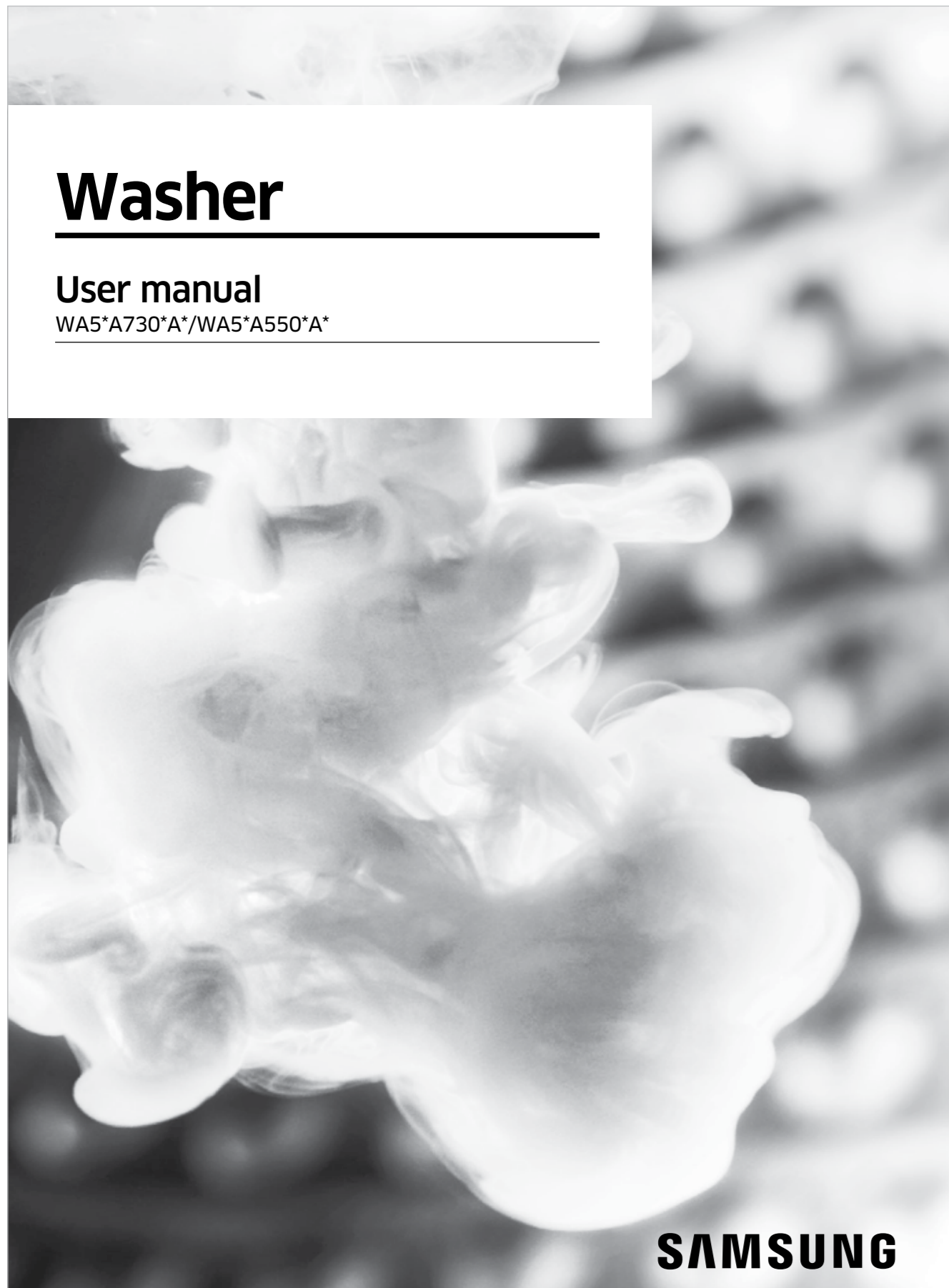

User Manual

Easy Ads link

<https://dam.gettyimages.com/p/z0c3461/external?o=AND&q=WA55A7300AE%20Warranty>

LIMITED WARRANTY (U.S.A.) – SAMSUNG TOP LOAD WASHER

Models:
WA55A7300AE

LIMITED WARRANTY TO ORIGINAL PURCHASER WITH PROOF OF PURCHASE

This SAMSUNG brand product, as supplied and distributed by SAMSUNG ELECTRONICS AMERICA, INC. (SAMSUNG) and delivered new, in the original carton to the original consumer purchaser, is warranted by SAMSUNG against manufacturing defects in materials or workmanship for the limited warranty period, starting from the date of original purchase, of:

One (1) year Parts and labor
Three (3) years Stainless tub part (Part Only)
Ten (10) years Washing DIT (Digital Inverter Motor) motor part (Part Only)
Twenty (20) years; Washing DIT (Digital Inverter Motor) motor part (Part Only)
Limited to "U.S.-assembled" washers only
Five (5) years Washing AC motor part (Part Only)

This limited warranty is valid only on products purchased and used in the United States that have been installed, operated, and maintained according to the instructions attached to or furnished with the product. To receive warranty service, the purchaser must contact SAMSUNG at the address or phone number provided below for problem determination and service procedures. Warranty service can only be performed by a SAMSUNG authorized service center. The original dated bill of sale must be presented upon request as proof of purchase to SAMSUNG or SAMSUNG's authorized service center to receive warranty service.

SAMSUNG will provide in-home service within the contiguous United States during the warranty period at no charge, subject to availability of SAMSUNG authorized servicers within the customer's geographic area. If in-home service is not available, SAMSUNG may elect, at its option, to provide transportation of the product to and from an authorized service center. If the product is located in an area where service by a SAMSUNG authorized servicer is not available, you may be responsible for a trip charge or require to bring the product to a SAMSUNG authorized service center for service.

To receive in-home service, product must be unobstructed and accessible to the service agent.

During the applicable warranty period, a product will be repaired, replaced, or the purchase price refunded, at the sole option of SAMSUNG. SAMSUNG may use new or reconditioned parts in repairing a product, or replace the product with a new or reconditioned product. Replacement parts and products are warranted for the remaining portion of the original product's warranty or ninety (90) days, whichever is longer. All replaced parts and products are the property of SAMSUNG and you must return them to SAMSUNG.

This limited warranty covers manufacturing defects in materials or workmanship encountered in normal household, noncommercial use of this product and shall not cover the following: damage that occurs in shipment, delivery, installation, and uses for which this product was not intended; damage caused by unauthorized modification or alteration of the product; product where the original factory serial numbers have been removed, defaced, changed in any way, or cannot be readily determined; cosmetic damage including scratches, dents, chips, and other damage to the product's finishes;

Warranty

Feature Icons

WA55A7300AE

**5.5 cu. ft. Extra-Large Capacity Smart Top Load Washer
with Super Speed Wash**

Feature Icons

Easy Ads link

<https://dam.gettyimages.com/p/z0c3461/external?o=AND&q=WA55A7300AE%20Icons>

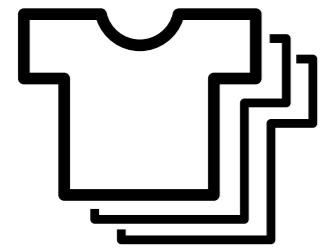

Extra-Large 5.5 cu. ft. Capacity



Super Speed Wash

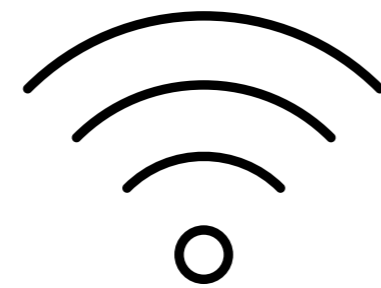

Wi-Fi Connectivity



Active WaterJet

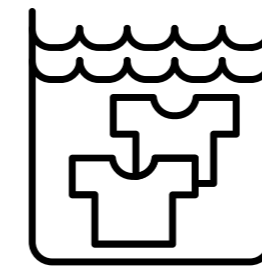

Deep Fill



Smart Care



20-Year Motor Warranty*

*20-year warranty limited to the Digital Inverter Motor of washers purchased on 7/1/2022 or later. Purchase receipt indicating purchase date required for a claim. Additional restrictions and limitations apply, see warranty for details.

Product Overview

DVE55A7300E / DVG55A7300E

7.4 cu. ft. Smart Electric Dryer with Steam Sanitize+

7.4 cu. ft. Smart Gas Dryer with Steam Sanitize+

Product Overview

Product Titles

DVE55A7300E - 7.4 cu. ft. Smart Electric Dryer with Steam Sanitize+

DVG55A7300E - 7.4 cu. ft. Smart Gas Dryer with Steam Sanitize+

Product Short Description (227 Characters)

Samsung's new Smart Dryer is Wi-Fi connected so you can receive end of cycle alerts and schedule laundry from your smartphone,* and has a Steam Sanitize+ cycle that eliminates 99.9% of germs and bacteria** while relaxing wrinkles.

Product Long Description (335 Characters)

Samsung's new Smart Dryer has integrated Wi-Fi that allows you to remotely start or stop your cycle, schedule laundry on your time, and receive end of cycle alerts and more, right from your smartphone.* Also, the Steam Sanitize+ cycle eliminates 99.9% of germs and bacteria** while relaxing and smoothing away wrinkles from everyday wear.

*Requires wireless network, Samsung account and SmartThings App. The Samsung SmartThings App supports Android OS 4.0 (ICS) or later which is optimized for Samsung smartphones (Galaxy S and Galaxy Note series). This app also supports iOS 7 or later for iPhone models. SmartThings App available in App Store and Play Store. Only monitoring enabled on Gas Dryers for safety reasons.

**Based on internal testing and independently verified by Intertek.

Available Color

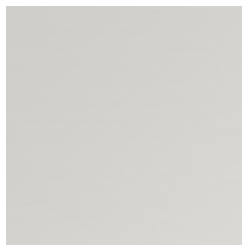

Ivory

Electric Dryer Model Number: DVE55A7300E

Electric Dryer UPC: 887276551609

Gas Dryer Model Number: DVG55A7300E

Gas Dryer UPC: 887276557823



Carousel Image Order

Easy Ads links

Retail.com: <https://dam.gettyimages.com/p/z0c3461/external?o=AND&q=DVE55A7300E%20Carousel%20Images%20RCOM>

Samsung.com: <https://dam.gettyimages.com/p/z0c3461/external?o=AND&q=DVE55A7300E%20Carousel%20Images%20SCOM>

360 Spin: DVE55A7300E <https://dam.gettyimages.com/p/z0c3461/external?o=AND&q=DVE55A7300E%20360%20Spins>

360 Spin: DVG55A7300E <https://dam.gettyimages.com/p/z0c3461/external?o=AND&q=DVG55A7300E%20360%20Spins>



Product Messaging



DVE55A7300E / DVG55A7300E

7.4 cu. ft. Smart Electric Dryer with Steam Sanitize+

7.4 cu. ft. Smart Gas Dryer with Steam Sanitize+

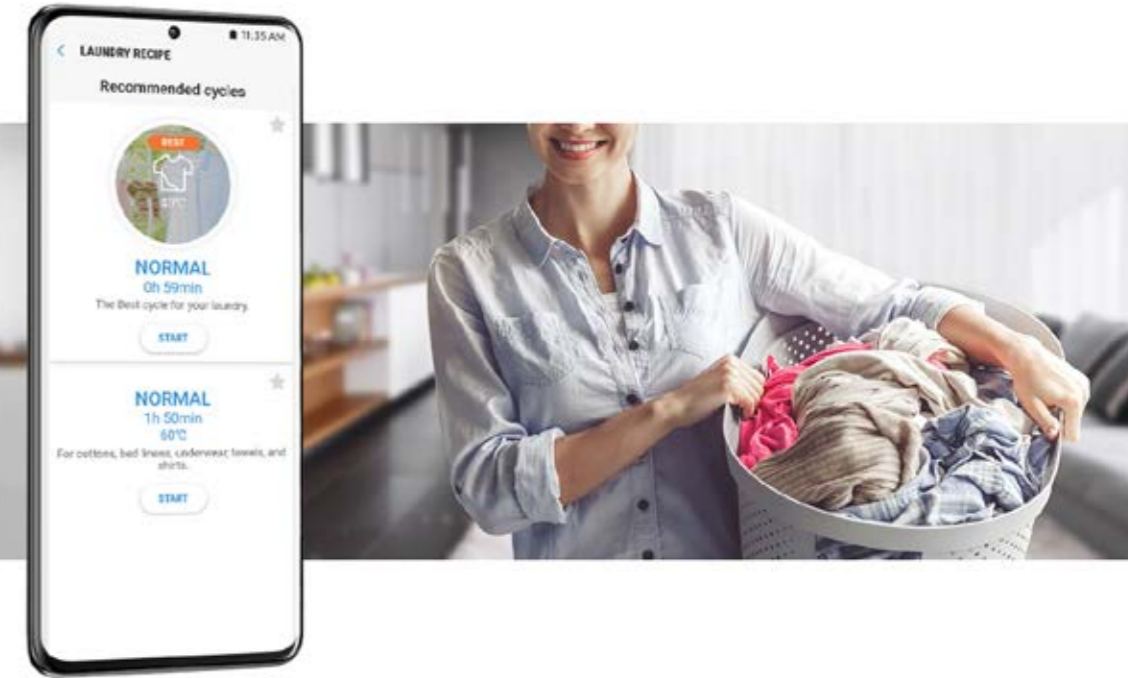

Features and Benefits: DVE(G)55A7300E

Ivory Dryer Easy Ads link: <https://dam.gettyimages.com/p/z0c3461/external?o=AND&q=DVE55A7300E%20Below%20The%20Fold>

Headline	Feature Name	Long Body Copy	Short Body Copy	Associated Image
<p>The New, Improved White</p>	<p>Ivory Finish</p>	<p>Samsung’s new premium ivory finish marries a timeless color with a sophisticated design, never before seen in laundry. Ivory is the latest offering in a palette of colors perfect to complement today’s design trends.</p>	<p>Samsung’s new premium ivory finish marries a timeless color with a sophisticated design, never before seen in laundry.</p>	
<p>Control in the palm of your hand</p>	<p>Wi-Fi Connectivity</p>	<p>Wi-Fi connected so you can receive end of cycle alerts, remotely start or stop your drying, schedule cycles on your time, and more, right from your smartphone with the SmartThings App.*</p> <p><small>*Requires wireless network, Samsung account and SmartThings App. The Samsung SmartThings App supports Android OS 4.0 (ICS) or later which is optimized for Samsung smartphones (Galaxy S and Galaxy Note series). This app also supports iOS 7 or later for iPhone models. SmartThings App available in App Store and Play Store. Only monitoring enabled on Gas Dryers for safety reasons.</small></p>	<p>Receive end of cycle alerts, remotely start, schedule, and more, from your smartphone with the SmartThings App.*</p> <p><small>*Requires wireless network, Samsung account and SmartThings App. The Samsung SmartThings App supports Android OS 4.0 (ICS) or later which is optimized for Samsung smartphones (Galaxy S and Galaxy Note series). This app also supports iOS 7 or later for iPhone models. SmartThings App available in App Store and Play Store. Only monitoring enabled on Gas Dryers for safety reasons.</small></p>	
<p>Freshen up clothes</p>	<p>Steam Sanitize+</p>	<p>The Steam Sanitize+ cycle removes 99.9% of germs and bacteria, over 95% of pollen, and kills 100% of dust mites.* Multi-Steam Technology steams away wrinkles, odors, and static.</p> <p><small>*Based on internal testing and independently verified by Intertek.</small></p>	<p>Steams away 99.9% of germs and bacteria,* while also reducing wrinkles and odors.</p> <p><small>*Based on internal testing and independently verified by Intertek.</small></p>	



Features and Benefits: DVE(G)55A7300E (Continued)

Ivory Dryer Easy Ads link: <https://dam.gettyimages.com/p/z0c3461/external?o=AND&q=DVE55A7300E%20Below%20The%20Fold>

Headline	Feature Name	Long Body Copy	Short Body Copy	Associated Image
N/A	ENERGY STAR® Certified	<p>ENERGY STAR® Certified,* so you can save money by using less energy without sacrificing performance or functionality.</p> <p><small>*Visit www.energystar.gov for more information on ENERGY STAR® guidelines.</small></p>	Eco-friendly and energy-efficient.	
Worry-free drying	Sensor Dry	Automatically optimizes the time and temperature of your drying cycle to protect your clothes from heat damage, while avoiding excess energy use.	Helps prevent overdrying for optimal fabric care.	
Cleaner, safer vents	Vent Sensor	Vent Sensor continually monitors the condition of your dryer's air duct to ensure it is operating safely and efficiently. It automatically notifies you when it is time for a cleaning and prompts you to check for obstructions, so you can always maintain optimum drying performance.	Continuously monitors the condition of the air duct to ensure it's operating safely and efficiently.	



Features and Benefits: DVE(G)55A7300E (Continued)

Ivory Dryer Easy Ads link: <https://dam.gettyimages.com/p/z0c3461/external?o=AND&q=DVE55A7300E%20Below%20The%20Fold>

Headline	Feature Name	Long Body Copy	Short Body Copy	Associated Image
<p>Easy to troubleshoot</p>	<p>Smart Care</p>	<p>Easy troubleshooting from the convenience of your smartphone.* Smart Care interacts with your washer and dryer to perform an immediate diagnosis and offer quick solutions.</p> <p><small>*Requires Samsung Smart Washer/Dryer App. The Samsung Smart Washer/Dryer App supports Android OS 2.3.6 or later and iOS 3 or later for iPhone models. Samsung Smart Washer/Dryer App available in App Store and Play Store.</small></p>	<p>Easy troubleshooting from the convenience of your smartphone.*</p> <p><small>*Requires Samsung Smart Washer/Dryer App. The Samsung Smart Washer/Dryer App supports Android OS 2.3.6 or later and iOS 3 or later for iPhone models. Samsung Smart Washer/Dryer App available in App Store and Play Store.</small></p>	
<p>N/A</p>	<p>Interior Drum Light</p>	<p>Put an end to stray socks or smaller laundry items that are hard to spot. An interior drum light brightly illuminates your laundry and the rest of the interior, so you can quickly and safely check your dryer's contents.</p>	<p>Put an end to stray socks or small items that are hard to spot.</p>	
<p>Flexible opening</p>	<p>Reversible Dryer Door</p>	<p>Choose the direction your dryer door opens to better suit your laundry room layout.</p>	<p>Choose the direction your dryer door opens.</p>	

Features and Benefits: DVE(G)55A7300E (Continued)

Ivory Dryer Easy Ads link: <https://dam.gettyimages.com/p/z0c3461/external?o=AND&q=DVE55A7300E%20Below%20The%20Fold>

Headline	Feature Name	Long Body Copy	Short Body Copy	Associated Image
<p>Easier use, for everyone</p>	<p>Accessibility (AUI, Braille)</p>	<p>Aiding the visually and hearing impaired, your washer and dryer now features audio assistance, playing a different sound for each option, and braille right next to key control panel buttons.</p>	<p>Designed for easy use for everyone.</p>	
<p>Fit more for fewer loads</p>	<p>Large 7.4 cu. ft. Capacity</p>	<p>Fewer loads, less time in the laundry room, and more time doing the things you love.</p>	<p>Fewer loads, less time in the laundry room.</p>	
<p>Stop the fluff</p>	<p>Lint Filter Indicator</p>	<p>Stop worrying about lint or fluff building up and blocking your dryer's air intake. The Lint Filter Indicator light on the control panel will provide you with a helpful reminder when it is time to clean the filter, so your dryer maintains optimal performance.</p>	<p>The Lint Filter Indicator light lets you know when it is time to clean the filter.</p>	

Product Specs

DVE55A7300E / DVG55A7300E

7.4 cu. ft. Smart Electric Dryer with Steam Sanitize+

7.4 cu. ft. Smart Gas Dryer with Steam Sanitize+

Related Products and Accessories

Washer Series	Gas Dryer Conversion Kit	Dryer Vent Kit
WA55A7300AE	LPKIT-4	DV-2A

Spec Sheets

Easy Ads link

https://dam.gettyimages.com/p/z0c3461/external?o=AND&q=DV*55A7300E%20Spec%20Sheet

DVE55A7300E
Samsung 7.4 cu. ft. Smart Electric Dryer with Steam Sanitize+



Available Color
Ivory
DVE55A7300E

Features

- Wi-Fi Connectivity*
- Steam Sanitize+
- ENERGY STAR® Rated
- Sensor Dry
- Vent Sensor
- Smart Care
- Interior Drum Light
- Reversible Door
- Stainless Steel Drum
- Accessibility (AU, Braille)
- Large 7.4 cu. ft. Capacity
- Lint Filter Indicator
- 18 Total Drying Cycles
- 10 Options
- 5 Temperature Settings
- 4-Way Venting (Back, Bottom, Left, Right)

Specifications

12 Preset Drying Cycles: Refresh, Steam Sanitize+, Normal, Heavy Duty, Permanent Press, Bedding, Delicates, Activewear, Time Dry, Air Fluff, Quick Dry, Downloaded

5 Dry Levels: More Dry, Normal-More Dry, Normal Dry, Normal-Less Dry, Less Dry

6 Downloadable Drying Cycles: Wrinkle Away, Eco Normal, Towels, Shirts, Denim, Rack Dry

10 Options: Damp Alert, Wrinkle Prevent, Adjust Time (Up), Adjust Time (Down), Child Lock, Sound On/Off, Eco Dry, Smart Care, Drum Light, Smart Control

5 Temperature Settings: High, Medium High, Medium, Medium Low, Low

Warranty
One (1) Year Parts and Labor

Product Dimensions & Weight (WxHxD)
Dimensions: 27" x 45¹³/₁₆" x 30¹/₄"
Weight: 119.0 lbs

Shipping Dimensions & Weight (WxHxD)
Dimensions: 29⁷/₁₆" x 48³/₁₆" x 31¹/₁₆"
Weight: 125.7 lbs

Convenience

- Child Lock
- Lint Filter Indicator

Rating

ENERGY STAR® Rated:
608 kWh/yr

Electrical Requirements
120 V / 240 V / 60 Hz
30 Amps

Electric Dryer	Model #	UPC Code
Ivory	DVE55A7300E	887276551609

Gas Dryer	Model #	UPC Code
Ivory	DVG55A7300E	887276557823

Matching Washer	Model #	UPC Code
Ivory	WA55A7300AE	887276751221

Optional Accessories	Model #	UPC Code
Vent Kit	DV-2A	887276146416

SAMSUNG

*Requires wireless network, Samsung account and SmartThings App. The Samsung SmartThings App supports Android OS 4.0 (ICS) or later which is optimized for Samsung smartphones (Galaxy S and Galaxy Note series). This app also supports iOS 7 or later for iPhone models. SmartThings App available in App Store and Play Store. Only monitoring enabled on Gas Dryers for safety reasons.

DVE55A7300E
Samsung 7.4 cu. ft. Smart Electric Dryer with Steam Sanitize+

Dimensions
Required dimensions for installation:

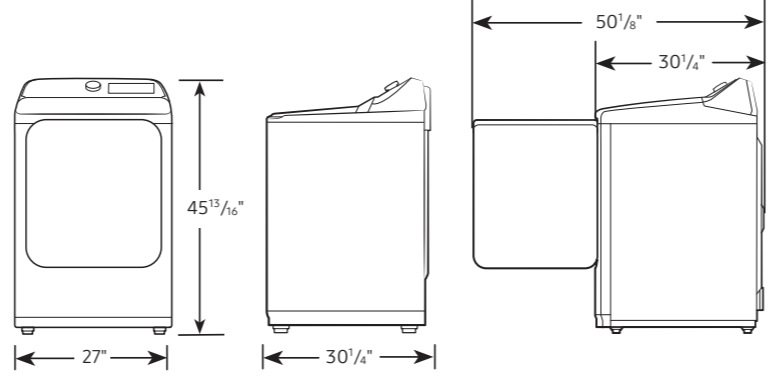

Installation Specifications – Side-by-Side
If the washer and dryer are installed together or the dryer alone, the closet front must have two unobstructed air openings for a combined minimum total area of 72-inch². Your washer alone does not require a specific air opening.

Alcove or closet installation
Minimum clearance for closet and alcove installations:

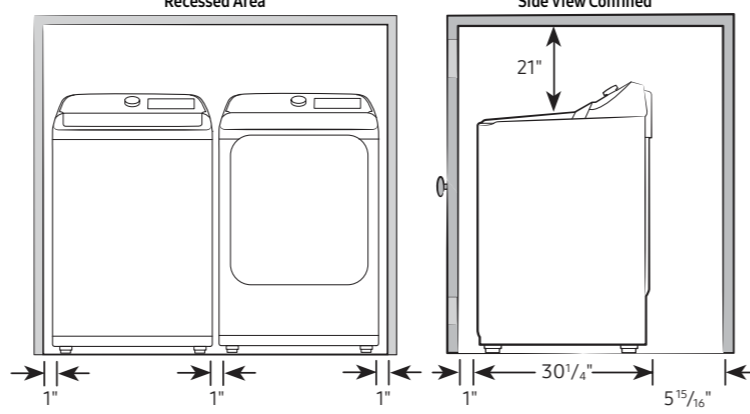

Connection Dimensions
Back and Side View of Electric Dryer

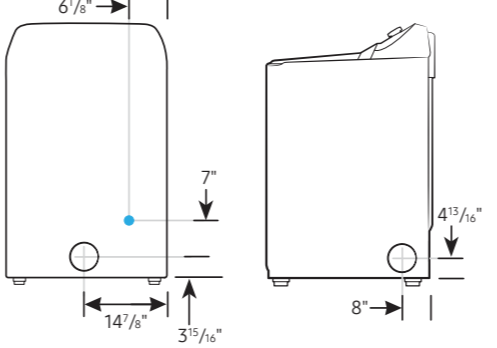

LEGEND:
● Cold Water Connection
● Gas Connection

Actual color may vary. Design, specifications, and color availability are subject to change without notice. Non-metric weights and measurements are approximate.
©2023 Samsung Electronics America, Inc.
85 Challenger Road, Ridgefield Park, NJ 07660.
16, 800-SAMSUNG, samsung.com, Samsung is a registered trademark of Samsung Electronics Co., Ltd.

SAMSUNG

Electric Dryer Spec Sheet - page 1

Electric Dryer Spec Sheet - page 2

DVG55A7300E
Samsung 7.4 cu. ft. Smart Gas Dryer with Steam Sanitize+



Available Color
Ivory
DVG55A7300E

Features

- Wi-Fi Connectivity*
- Steam Sanitize+
- ENERGY STAR® Rated
- Sensor Dry
- Vent Sensor
- Smart Care
- Interior Drum Light
- Reversible Door
- Stainless Steel Drum
- Accessibility (AU, Braille)
- Large 7.4 cu. ft. Capacity
- Lint Filter Indicator
- 18 Total Drying Cycles
- 10 Options
- 5 Temperature Settings
- 3-Way Venting (Back, Bottom, Left)

Specifications

12 Preset Drying Cycles: Refresh, Steam Sanitize+, Normal, Heavy Duty, Permanent Press, Bedding, Delicates, Activewear, Time Dry, Air Fluff, Quick Dry, Downloaded

6 Downloadable Drying Cycles: Wrinkle Away, Eco Normal, Towels, Shirts, Denim, Rack Dry

10 Options: Damp Alert, Wrinkle Prevent, Adjust Time (Up), Adjust Time (Down), Child Lock, Sound On/Off, Eco Dry, Smart Care, Drum Light, Smart Control

5 Temperature Settings: High, Medium High, Medium, Medium Low, Low

Convenience

- Child Lock
- Lint Filter Indicator

Electrical Requirements
120 V / 60 Hz
15 Amps

Gas Dryer	Model #	UPC Code
Ivory	DVG55A7300E	887276557823

Electric Dryer	Model #	UPC Code
Ivory	DVE55A7300E	887276551609

Matching Washer	Model #	UPC Code
Ivory	WA55A7300AE	887276751221

Optional Accessories	Model #	UPC Code
Vent Kit	DV-2A	887276146416
Gas to Propane Converter Kit	LPKIT-4	887276352787

SAMSUNG

*Requires wireless network, Samsung account and SmartThings App. The Samsung SmartThings App supports Android OS 4.0 (ICS) or later which is optimized for Samsung smartphones (Galaxy S and Galaxy Note series). This app also supports iOS 7 or later for iPhone models. SmartThings App available in App Store and Play Store. Only monitoring enabled on Gas Dryers for safety reasons.

Gas Dryer Spec Sheet - page 1

DVG55A7300E
Samsung 7.4 cu. ft. Smart Gas Dryer with Steam Sanitize+

Dimensions
Required dimensions for installation:

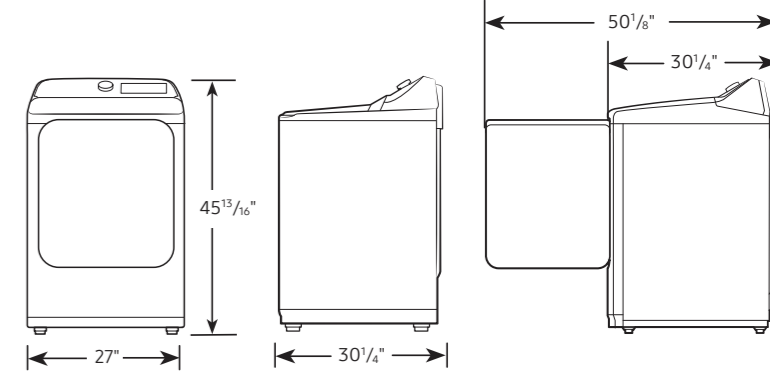

Installation Specifications – Side-by-Side
If the washer and dryer are installed together or the dryer alone, the closet front must have two unobstructed air openings for a combined minimum total area of 72-inch². Your washer alone does not require a specific air opening.

Alcove or closet installation
Minimum clearance for closet and alcove installations:

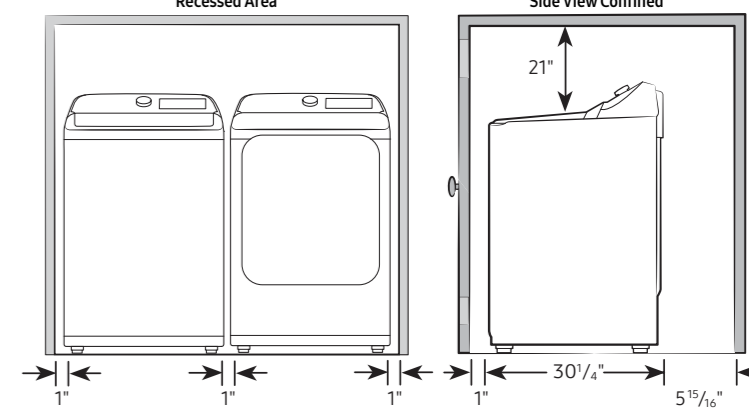

Connection Dimensions
Back and Side View of Gas Dryer

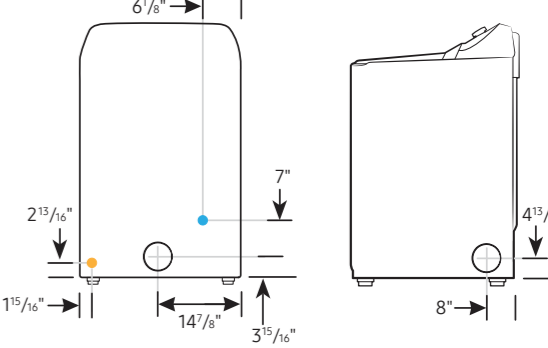

LEGEND:
● Cold Water Connection
● Gas Connection

Actual color may vary. Design, specifications, and color availability are subject to change without notice. Non-metric weights and measurements are approximate.
©2023 Samsung Electronics America, Inc.
85 Challenger Road, Ridgefield Park, NJ 07660.
16, 800-SAMSUNG, samsung.com, Samsung is a registered trademark of Samsung Electronics Co., Ltd.

SAMSUNG

Gas Dryer Spec Sheet - page 2

User Manual and Warranty

Easy Ads link

<https://dam.gettyimages.com/p/z0c3461/external?o=AND&q=DVE55A7300E%20User%20Manual>

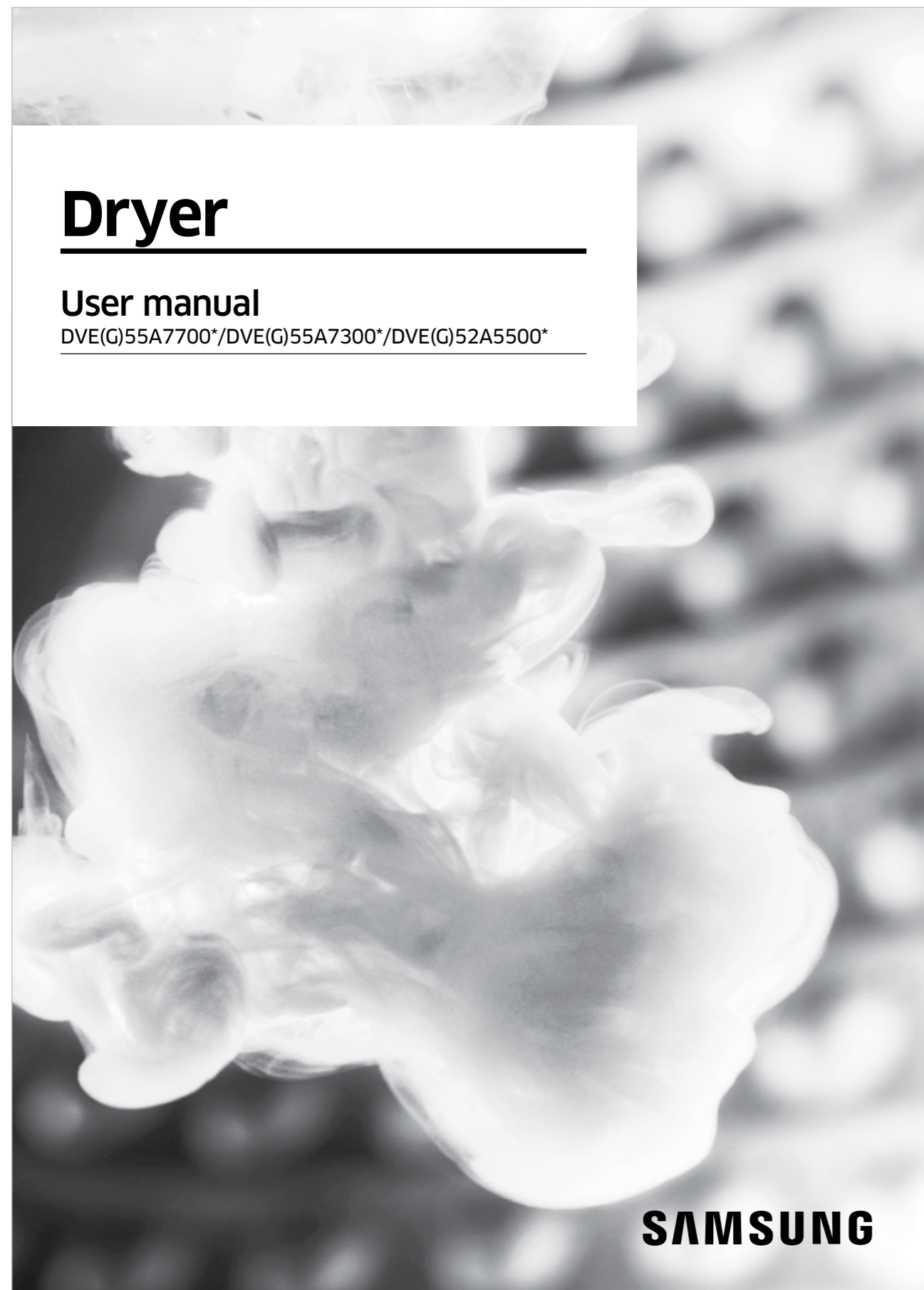

User Manual - Electric and Gas Dryers

Easy Ads link

<https://dam.gettyimages.com/p/z0c3461/external?o=AND&q=DVE55A7300E%20Warranty>

Warranty (U.S.A) – SAMSUNG DRYER

Models:
DVE(G)55A7300E

LIMITED WARRANTY TO ORIGINAL PURCHASER WITH PROOF OF PURCHASE

This SAMSUNG brand product, as supplied and distributed by SAMSUNG ELECTRONICS AMERICA INC. (SAMSUNG) and delivered new, in the original carton to the original consumer purchaser, is warranted by SAMSUNG against manufacturing defects in materials or workmanship for the limited warranty period, starting from the date of original purchase, of:

One (1) Year Parts and Labor

This limited warranty is valid only on products purchased and used in the United States that have been installed, operated, and maintained according to the instructions attached to or furnished with the product. To receive warranty service, the purchaser must contact SAMSUNG at the address or phone number provided below for problem determination and service procedures. Warranty service can only be performed by a SAMSUNG authorized service center. The original dated bill of sale must be presented upon request as proof of purchase to SAMSUNG or SAMSUNG's authorized service center to receive warranty service.

SAMSUNG will provide in-home service within the contiguous United States during the warranty period at no charge, subject to availability of SAMSUNG authorized servicers within the customer's geographic area. If in-home service is not available, SAMSUNG may elect, at its option, to provide transportation of the product to and from an authorized service center. If the product is located in an area where service by a SAMSUNG authorized servicer is not available, you may be responsible for a trip charge or required to bring the product to a SAMSUNG authorized service center for service.

To receive in-home service, product must be unobstructed and accessible to the service agent.

During the applicable warranty period, a product will be repaired, replaced, or the purchase price refunded, at the sole option of SAMSUNG. SAMSUNG may use new or reconditioned parts in repairing a product, or replace the product with a new or reconditioned product. Replacement parts and products are warranted for the remaining portion of the original product's warranty or ninety (90) days, whichever is longer. All replaced parts and products are the property of SAMSUNG and you must return them to SAMSUNG.

This limited warranty covers manufacturing defects in materials or workmanship encountered in normal household, noncommercial use of this product and shall not cover the following: damage that occurs in shipment, delivery, installation, and uses for which this product was not intended; damage caused by unauthorized modification or alteration of the product; product where the original factory serial numbers have been removed, defaced, changed in any way, or cannot be readily determined; cosmetic damage including scratches, dents, chips, and other damage to the product's finishes; damage caused by abuse, misuse, pest infestations, accident, fire, floods, or other acts

Warranty - Electric and Gas Dryers

Feature Icons

DVE55A7300E / DVG55A7300E

7.4 cu. ft. Smart Electric Dryer with Steam Sanitize+

7.4 cu. ft. Smart Gas Dryer with Steam Sanitize+

Feature Icons

Easy Ads link

<https://dam.gettyimages.com/p/z0c3461/external?o=AND&q=DVE55A7300E%20Icons>

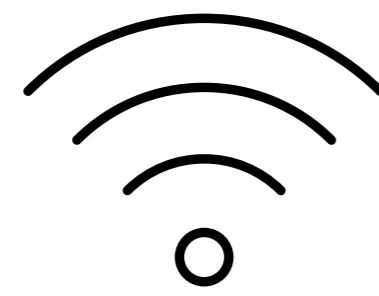

Wi-Fi Connectivity

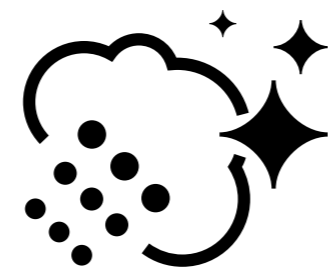

Steam Sanitize+



ENERGY STAR® Certified

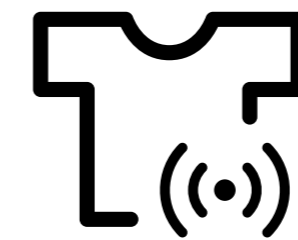

Sensor Dry

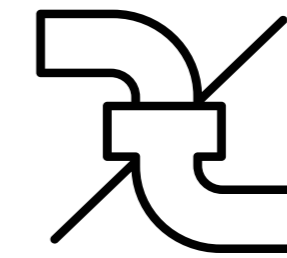

Vent Sensor

SAMSUNG