

# SAMSUNG

# Product Guide

## 6221 Series Refrigerator

RF28R6221SR

Available in Fingerprint Resistant Stainless Steel



# Table of Contents

## RF28R6221SR – 3-Door French Door Refrigerator with AutoFill Water Pitcher

### Product Overview

Product Overview 4

Carousel Image Order and Assets 5

### Product Messaging

Core Messaging 7

Features and Benefits 8

### Product Specs

Review Mapping and Related Products 13

Spec Sheet 14

Energy Guide and Manual 15

### Feature Icons

17

# Product Overview

---

**RF28R6221SR – 28 cu. ft. 3-Door French Door Refrigerator  
with AutoFill Water Pitcher**

# Product Overview

## Product Title

28 cu. ft. 3-Door French Door Refrigerator with AutoFill Water Pitcher

## Product Long Description (284 characters)\*

Samsung's 3-Door French Door 28 cu. ft. refrigerator, is beautifully designed with a minimal display dispenser, sleek-edge doors, and a AutoFill Water Pitcher. A refrigerator with a modern design that blends beautifully into your kitchen and a finish that withstands everyday smudges.

\*Product description should be updated based upon color set-up.

## Available Color



**Fingerprint Resistant  
Stainless Steel**  
RF28R6221SR



# Carousel Image Order

Easy Ads links

Fingerprint Resistant Stainless Steel: <http://www.samsungeasyads.com/mm/nicePath/easyads?nav=pr657645460>



# Product Messaging

---

**RF28R6221SR – 28 cu. ft. 3-Door French Door Refrigerator  
with AutoFill Water Pitcher**

# Core Messaging

Priority	Feature	Short Copy (< 65 Characters)	Long Copy (< 300 Characters)	
Signature	1	<b>AutoFill Water Pitcher</b>	A built-in pitcher that automatically refills with filtered water	A built-in pitcher that automatically refills with filtered water and the option to infuse with a flavor of your choice
	2	<b>Twin Cooling Plus®</b>	Keeps food fresher longer	Independent fridge and freezer controls keep food fresher longer
	3	<b>CoolSelect Pantry™</b>	Chill or defrost food to ideal temperatures	Full-width drawer with three temperature control settings to chill or defrost food to ideal temperatures
Secondary Features	4	<b>Ice Max™</b>	Stores up to 4.2 lbs. of ice	Large capacity, stores up to 4.2 lbs. of ice
	5	<b>Fingerprint Resistant Finish</b>	Helps reduce smudges and minimize cleaning	A special finish to reduce smudges and minimize cleaning
	6	<b>Wi-Fi Enabled</b>	Control and monitor your fridge remotely	Use your smartphone to control the temperature and monitor your refrigerator remotely
	7	<b>Adjustable Shelves</b>	Adjustable shelves to fit taller items	Adjustable shelves go from standard to slide-in or flip-up, to fit taller items
	8	<b>High-Efficiency LED Lighting</b>	LED lighting designed to beautifully light up the interior of your fridge	LED lighting designed to beautifully light up the interior of your fridge so you can quickly spot what you want
	9	<b>Accessibility (ADA Compliant)</b>	Easy to reach controls for everyone	Easy to reach controls for everyone
	10	<b>ENERGY STAR® Certified</b>	Eco-friendly and energy-efficient*	Eco-friendly and energy-efficient*

\*Visit [www.energystar.gov](http://www.energystar.gov) for more information on ENERGY STAR® guidelines.

## Features and Benefits



### AutoFill Water Pitcher

A built-in pitcher that automatically refills with filtered water and the option to infuse with a flavor of your choice.



### Twin Cooling Plus®

Independent fridge and freezer controls keep food fresher longer.

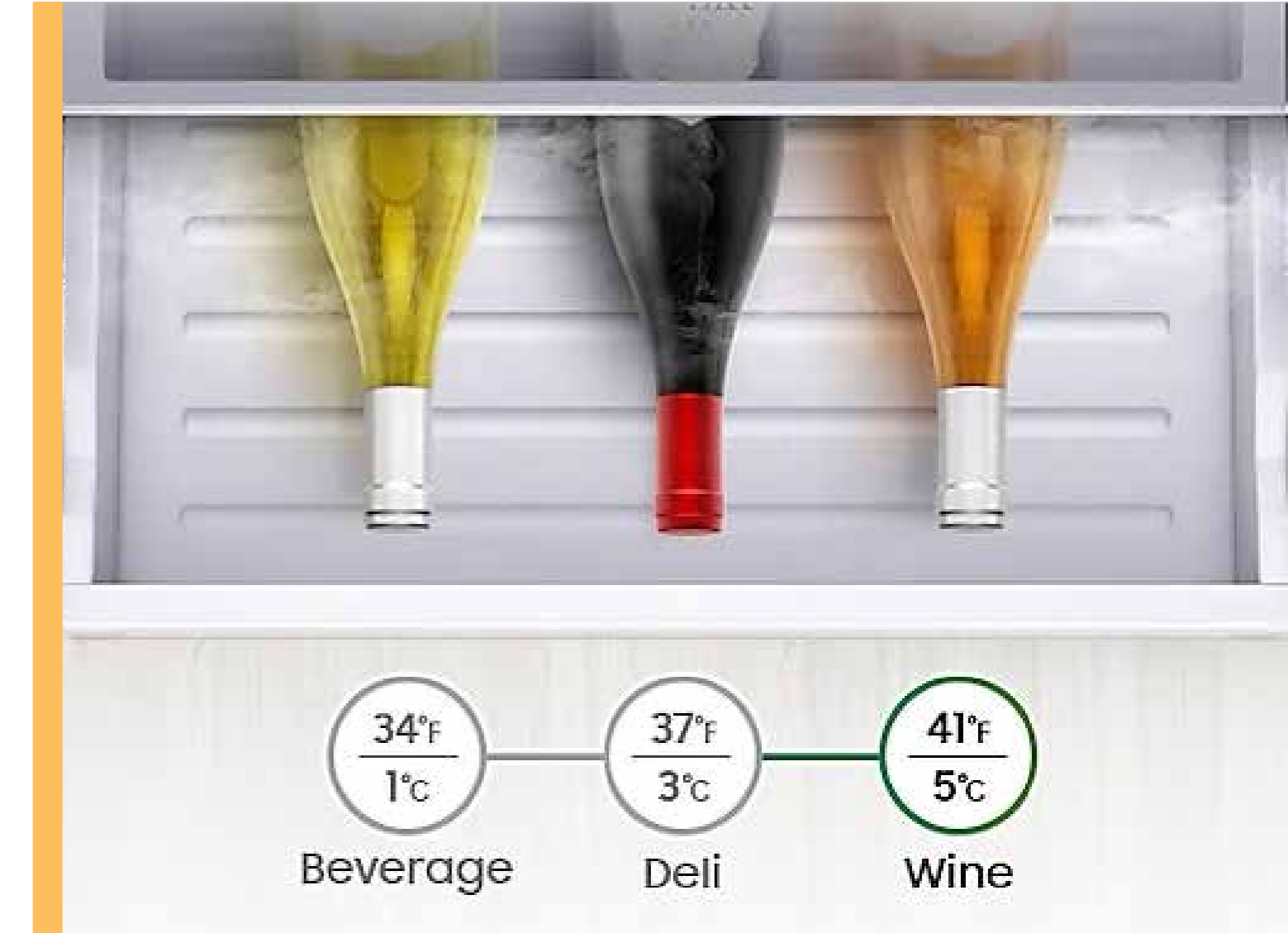

### CoolSelect Pantry™

Full-width drawer with three temperature control settings to chill or defrost food to ideal temperatures.

**Easy Ads link**

**Fingerprint Resistant Stainless Steel:** <http://www.samsungeasyads.com/mm/nicePath/easyads?nav=pr658241573>



## Features and Benefits (continued)



### Ice Max™

Large capacity, stores up to 4.2 lbs. of ice.

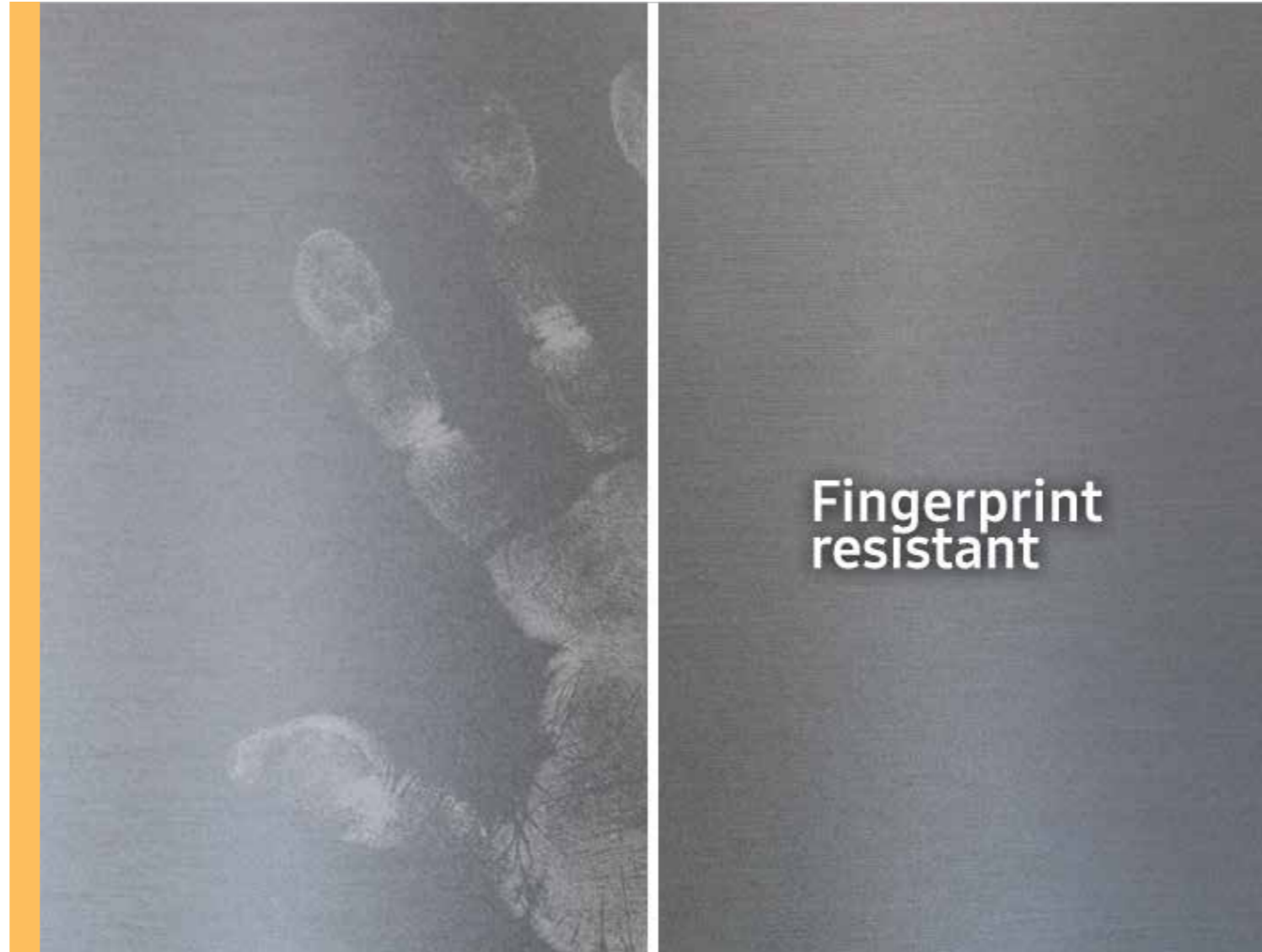

Fingerprint  
resistant

### Fingerprint Resistant Finish

A finish that withstands everyday smudges, so you spend less time cleaning.



### Wi-Fi Enabled

Use your smartphone to control the temperature and monitor your refrigerator remotely.

**Easy Ads link**

**Fingerprint Resistant Stainless Steel:** <http://www.samsungeasyads.com/mm/nicePath/easyads?nav=pr658241573>

## Features and Benefits (continued)



### Adjustable Shelves

Adjustable shelves go from standard to slide-in or flip-up, to fit taller items.



### High-Efficiency LED Lighting

LED lighting designed to beautifully light up the interior of your fridge so you can quickly spot what you want.



### ADA Compliant

Display is located within 15 and 48 inches from floor

### Accessibility (ADA Compliant)

Easy to reach controls for everyone.

**Easy Ads link**  
**Fingerprint Resistant Stainless Steel:** <http://www.samsungeasyads.com/mm/nicePath/easyads?nav=pr658241573>



**ENERGY STAR® Certified**  
Eco-friendly and energy-efficient\*

\*Visit [www.energystar.gov](http://www.energystar.gov) for more information on ENERGY STAR® guidelines.

**Easy Ads link**

**Fingerprint Resistant Stainless Steel:** <http://www.samsungeasyads.com/mm/nicePath/easyads?nav=pr658241573>

# Product Specs

---

**RF28R6221SR – 28 cu. ft. 3-Door French Door Refrigerator  
with AutoFill Water Pitcher**

## Review Mapping

SKU	Type	Color
RF28R6221SR	3-Door French Door	Fingerprint Resistant Stainless Steel

## Related Products

Water Filter
HAF-QIN

# Spec Sheet

## Easy Ads link

<http://www.samsungeasyads.com/mm/nicePath/easyads?nav=pr657645436>

## RF28R6221SR

28 cu. ft. 3-Door French Door Refrigerator with AutoFill Water Pitcher

SAMSUNG



### Signature Features

#### AutoFill Water Pitcher

A built-in pitcher that automatically refills with filtered water and the option to infuse with a flavor of your choice.

#### CoolSelect Pantry™

Full-width drawer with three temperature control settings to chill or defrost food to ideal temperatures.

#### Ice Max

Large capacity, stores up to 4.2 lbs of ice.

#### Fingerprint Resistant Finish

A special finish to reduce smudges and minimize cleaning.

#### Wi-Fi and Bixby Enabled

Use your smartphone to control the temperature and monitor your refrigerator remotely.



AutoFill Water Pitcher



CoolSelect Pantry™ with Temperature Control

### Available Color

Fingerprint Resistant Stainless Steel

### Convenience

- CoolSelect Pantry™ with Temperature Control and Pantry Divider
- Wi-Fi and Bixby Enabled
- Adjustable Shelves for Tall Oversized Items
- Auto Pull-Out Upper Freezer Drawer
- Water Filter Indicator

### Design

- AutoFill Water Pitcher
- Fingerprint Resistant Finish
- Premium External Filtered Water and Ice Dispenser with Light
- High Efficiency LED Lighting
- Accessibility (ADA Compliant)
- EZ-Open Handle™ on Freezer Door
- Tempered Glass Spill-Proof Shelves
- Gallon Door Bins

### Performance

- Twin Cooling Plus®
- Ice Max - Stores up to 4.2 lbs of Ice
- ENERGY STAR® Compliant
- Two Humidity-Controlled Crispers
- Power Freeze and Power Cool Options
- CoolTight Door
- Door Alarm

### Rating

ENERGY STAR® rated:  
725 kWh/yr

Spec Sheet - front

## RF28R6221SR

28 cu. ft. 3-Door French Door Refrigerator with AutoFill Water Pitcher

SAMSUNG

### Installation Specifications

1. Measure the height, width and depth of the opening, making sure to include baseboards, molding, tile, countertop overhang, etc. Check to be sure there is enough room to open the door (consider walls, islands or other obstacles when measuring).
2. Refer to illustration below to determine dimensions.
3. Allow 2.5" of clearance on hinge side of refrigerator when installing next to a wall where handle may make contact.
4. Allow 1" minimum clearance at rear for proper air circulation and water/electrical connections. Allow a 3/8" minimum clearance at sides and top for ease of installation.
5. Ensure each door and entryway in the home is wide enough for the refrigerator to be moved through easily.

For optimal usage and to be able to open refrigerator doors completely, do not install next to a wall.

Please note: The following dimension and cutout information is for planning purposes only. For complete installation details, consult manual packed with product, or download manual online at [samsung.com](http://samsung.com).

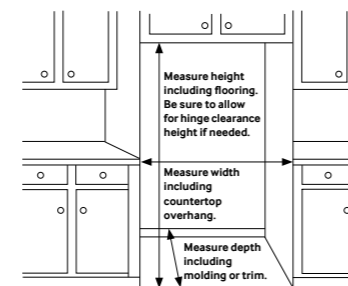

### Dimensions

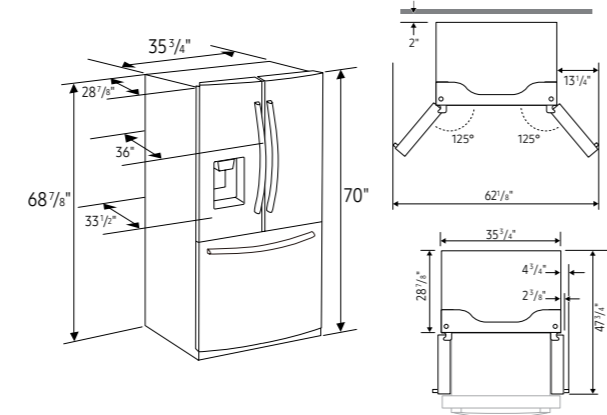

Actual color may vary. Design, specifications, and color availability are subject to change without notice. Non-metric weights and measurements are approximate.  
©2020 Samsung Electronics America, Inc., 49 Challenger Road, Ridgefield Park, NJ 07660. Tel: 800-SAMSUNG, [samsung.com](http://samsung.com). Samsung is a registered trademark of Samsung Electronics Co., Ltd.

Spec Sheet - back

### Total Capacity: 28 cu. ft.

#### Refrigerator: 19.1 cu. ft.

- Premium External Filtered Water and Ice Dispenser - Crushed or Cubed Ice
- Ice Max
- CoolSelect Pantry™ with Temperature Control - Deli (41°F), Fresh (38°F) and Chilled (32°F) Options
- Pantry Divider
- 2 Humidity-Controlled Crispers
- 5 Tempered Glass Spill-Proof Shelves:
  - 1 Slide-In
  - 1 Foldable Half
  - 3 Fixed
- 6 Clear Door Bins
  - Right Door: 3 Gallon Bins
  - Left Door: 3 Regular Bins
- Adjustable Shelves for Tall Oversized Items
- High Efficiency Top LED Lighting

#### Freezer: 8.9 cu. ft.

- EZ-Open Handle™
- 2 Drawer Dividers
- High Efficiency LED Lighting

### Accessories

Water Filter: HAF-QIN

### Warranty

One (1) Year Parts and Labor on Refrigerator  
Five (5) Years Parts and Labor on Sealed Refrigeration System Only\*  
Ten (10) Years Parts and Five (5) Years Labor on Digital Inverter Compressor  
\*Compressor, evaporator, condenser, drier and connecting tubing.

### Product Dimensions & Weight

Dimensions (WxHxD with hinges, handles and doors):

35 1/4" x 70" x 36"

Dimensions (WxHxD without hinges and door):

35 1/4" x 68 7/8" x 28 1/8"

Dimensions (WxHxD with hinge and door, no handle):

35 1/4" x 70" x 33 1/2"

Weight: 310 lbs

### Shipping Dimensions & Weight (WxHxD)

Dimensions: 38 3/8" x 76 5/8" x 36 1/8"

Weight: 320 lbs

### Color

Fingerprint Resistant  
Stainless Steel

### Model #

RF28R6221SR

### UPC Code

887276405872

# Energy Guide and Manual

## Easy Ads link

<http://www.samsungeasyads.com/mm/nicePath/easyads?nav=pr657645436>

U.S. Government Federal law prohibits removal of this label before consumer purchase.

# ENERGYGUIDE

Refrigerator-Freezer  
 • Automatic Defrost  
 • Bottom-Mounted Freezer  
 • Through-the-Door Ice Service

Samsung  
 Model RF28R6221\*\*  
 Capacity: 28.0 Cubic Feet

**Compare ONLY to other labels with yellow numbers.**  
 Labels with yellow numbers are based on the same test procedures.

**Estimated Yearly Energy Cost**  
**\$87**

Cost Ranges	Models with similar features	\$74	\$95
	All models	\$74	\$104

**725 kWh**  
 Estimated Yearly Electricity Use



- Your cost will depend on your utility rates and use.
- Both cost ranges based on models of similar size capacity.
- Models with similar features have automatic defrost, bottom-mounted freezer, and through-the-door ice.
- Estimated energy cost based on a national average electricity cost of 12 cents per kWh.

[ftc.gov/energy](http://ftc.gov/energy)

Energy Guide

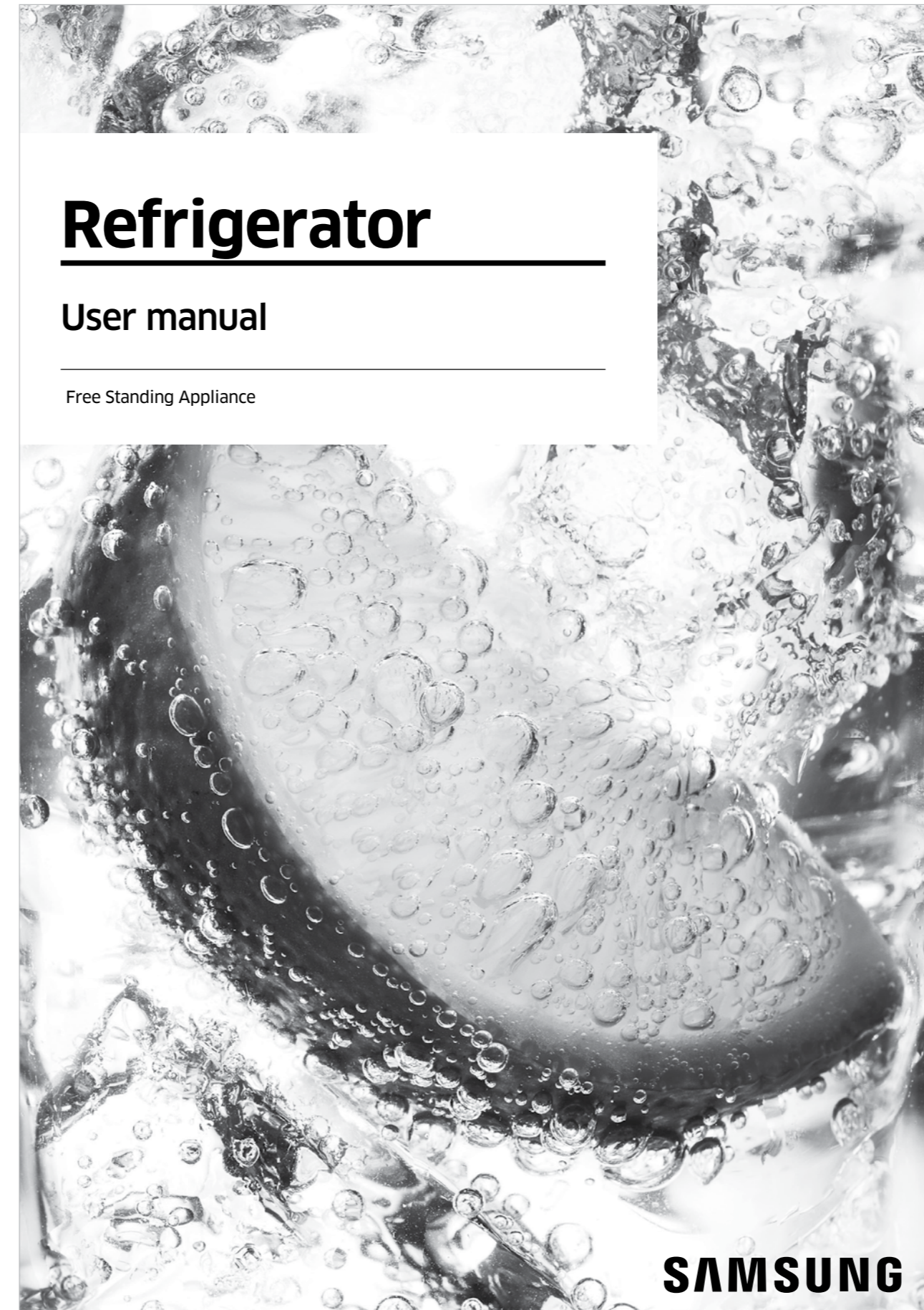

User Manual

# Feature Icons

---

**RF28R6221SR – 28 cu. ft. 3-Door French Door Refrigerator  
with AutoFill Water Pitcher**



# Feature Icons

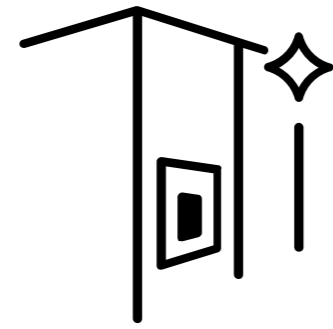

Modern Design

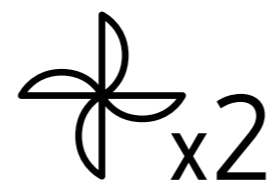

Twin Cooling Plus®



Ice Max™



Fingerprint Resistant Finish

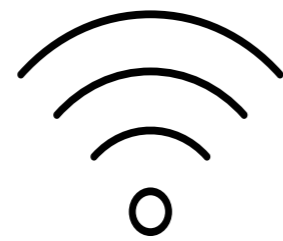

Wi-Fi Connectivity

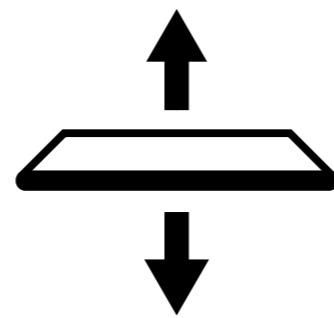

Adjustable Shelving

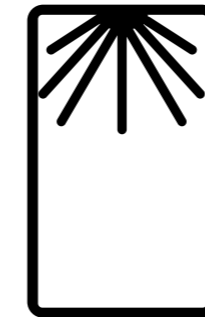

High-Efficiency LED Lighting



ENERGY STAR® Certified

**SAMSUNG**