

# SAMSUNG

# Product Guide

## Laundry Accessories



# Table of Contents

Bespoke AI Laundry Combo™ Pedestal with Storage Drawer	3
Stacking Kit for DV45DG6000HW Heat Pump Dryer and Matching Washer	8
Less Microfiber™ Filter	12
Bespoke Stacking & MultiControl™ Combo Kit	20
Bespoke Heat Pump Stacking & MultiControl™ Combo Kit	29
MultiControl™ & Stacking Kit	32
Bespoke Front Load Pedestal	36
Front Load Pedestal	44
Front Load Riser	50

# Product Overview

## Product Title

Bespoke AI Laundry Combo™ Pedestal with Storage Drawer

## Product Description (197 characters)

This Bespoke AI Laundry Combo™ compatible pedestal lifts your machine by more than a foot for a more convenient height. Tidy up your laundry space with an easily accessible built-in storage drawer.

- Beautiful, flat panel design creates a seamless, integrated look.
- Compatible with the Samsung Bespoke AI Laundry Combo™.
- Elevates your AI Laundry Combo™ by more than a foot, for easier loading and unloading – no more bending.
- Provides an easily accessible storage drawer for your laundry cleaning supplies.



## Available Color



**Dark Steel**

**Model Number:** WE702NZ

**UPC:** 887276894676

# Carousel Image Order

Easy Ads links

Retail.com: <https://dam.gettyimages.com/p/z0c3461/digital-appliances?o=AND&q=WE702NZ%20Carousel%20Images%20RCOM>  
Samsung.com: <https://dam.gettyimages.com/p/z0c3461/digital-appliances?o=AND&q=WE702NZ%20Carousel%20Images%20SCOM>

WE702NZ



Image provided in decimals and fractions.



# Lifestyle Image

## Easy Ads link

<https://dam.gettyimages.com/p/z0c3461/digital-appliances?o=AND&q=WE702NZ%20Lifestyle%20Images>



# Spec Sheet

## Easy Ads link

<https://dam.gettyimages.com/p/z0c3461/digital-appliances?o=AND&q=WE702NZ%20Spec%20Sheet>

## WE702NZ

Bespoke AI Laundry Combo™ Pedestal  
with Storage Drawer

**SAMSUNG**



**Available Color**

Dark Steel

**Signature Features:**

- Beautiful, flat panel design creates a seamless, integrated look.
- Compatible with the Samsung Bespoke AI Laundry Combo™.
- Elevates your AI Laundry Combo™ by more than a foot, for easier loading and unloading – no more bending.
- Provides an easily accessible storage drawer for your laundry cleaning supplies.

---

<p><b>Product Dimensions &amp; Weight (WxHxD)</b> Dimensions: 27" x 15" x 30 7/8" Weight: 47.2 lbs</p>	<p><b>Color</b> Dark Steel</p>	<p><b>Model #</b> WE702NZ</p>	<p><b>UPC Code</b> 887276894676</p>
<p><b>Shipping Dimensions &amp; Weight (WxHxD)</b> Dimensions: 29 13/16" x 17 1/8" x 34 1/2" Weight: 58.2 lbs</p>	<p><b>Warranty</b> One (1) Year Parts and Labor</p>		

Actual color may vary. Design, specifications, and color availability are subject to change without notice. Non-metric weights and measurements are approximate.  
©2024 Samsung Electronics America, Inc. 85 Challenger Road, Ridgefield Park, NJ 07660. Tel: 800-SAMSUNG, samsung.com. Samsung is a registered trademark of Samsung Electronics Co., Ltd.

WE702NZ Spec Sheet

# Installation Guide / Warranty

## Easy Ads link

<https://dam.gettyimages.com/p/z0c3461/digital-appliances?o=AND&q=WE702NZ%20Installation%20Guide>

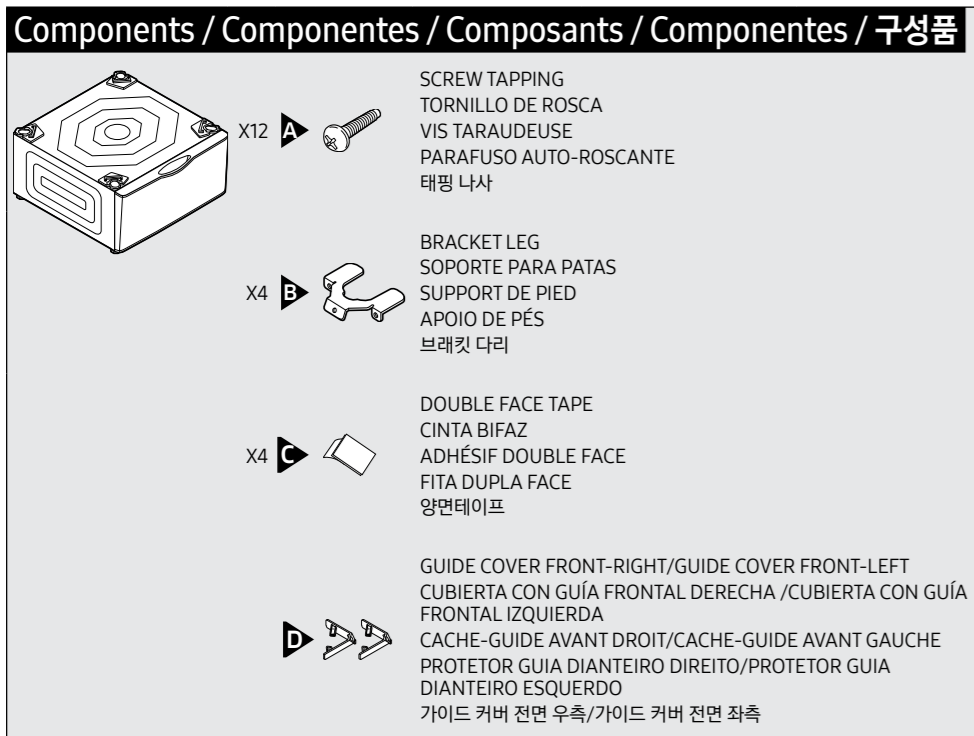

**Pedestal Installation Instructions / Instrucciones de instalación del pedestal / Instructions pour l'installation du socle / Instruções para instalação com pedestal / 받침대 설치 지침**

**Components / Componentes / Composants / Componentes / 구성품**

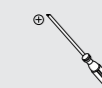

- SCREW TAPPING**  
TORNILLO DE ROSCA  
VIS TARAUDEUSE  
PARAFUSO AUTO-ROSCANTE  
태핑 나사
- BRACKET LEG**  
SOPORTE PARA PATAS  
SUPPORT DE PIED  
APOIO DE PÉS  
브래킷 다리
- DOUBLE FACE TAPE**  
CINTA BIFAZ  
ADHÉSIF DOUBLE FACE  
FITA DUPLA FACE  
양면테이프
- GUIDE COVER FRONT-RIGHT/GUIDE COVER FRONT-LEFT**  
CUBIERTA CON GUÍA FRONTAL DERECHA / CUBIERTA CON GUÍA FRONTAL IZQUIERDA  
CACHE-GUIDE AVANT DROIT/CACHE-GUIDE AVANT GAUCHE  
PROTECTOR GUIA DIANTEIRO DIREITO/PROTECTOR GUIA DIANTEIRO ESQUERDO  
가이드 커버 전면 우측/가이드 커버 전면 좌측

**Tools / Herramientas / Outils / Ferramentas / 공구**

		
<b>Wrench / Llave inglesa / Clé anglaise / Chave inglesa / 렌치</b> Supplied with Washing Machine or General Wrench (9/16 inch or 14 mm) La suministrada con la lavadora o una llave inglesa general (9/16 pulgadas o 14 mm) Livrée avec le lave-linge ou la clé générale (9/16 pouces ou 14 mm) Fornecida com a lavadora de roupas ou com uma chave inglesa geral (9/16 polegadas ou 14 mm) 세탁기와 함께 제공되는 렌치 또는 일반 렌치(9/16인치 또는 14mm)	<b>Phillips Screwdriver</b> Destornillador Phillips Tournevis cruciforme Chave de fenda Phillips 필립스 스크루드라이버	<b>Flat Screwdriver</b> Destornillador plano Tournevis plat Chave de fenda de ponta chata 일자 스크루드라이버

**Caution / Atención / Attention / Cuidado / 경고**  
To prevent a fall, use caution when mounting the washer or dryer on top of the pedestal. / Para evitar una caída, tenga cuidado al instalar la lavadora o la secadora en el pedestal. / Pour éviter toute chute, soyez attentifs lors du montage du lave-linge ou du sèche-linge sur le dessus du socle. / Para evitar uma queda, tenha cuidado ao montar a lavadora de roupas ou a secadora sobre o pedestal. / 세탁기나 건조기를 받침대에 올릴 때 전도되지 않도록 주의하세요.

Code No. : DC68-02931D-04

WE702NZ Installation Guide

## Easy Ads link

<https://dam.gettyimages.com/p/z0c3461/digital-appliances?o=AND&q=WE702NZ%20Warranty>

**LIMITED WARRANTY (U.S.A.) – SAMSUNG LAUNDRY PEDESTAL WE702NZ**

**SAMSUNG LAUNDRY PEDESTAL LIMITED WARRANTY TO ORIGINAL PURCHASER AND/OR PROOF OF DELIVERY**

This SAMSUNG brand product, as supplied and distributed by SAMSUNG ELECTRONICS AMERICA, INC. (SAMSUNG) and delivered new, in the original carton to the original consumer purchaser, is warranted by SAMSUNG against manufacturing defects in materials or workmanship for the following limited warranty periods, starting on the date of delivery to the original consumer purchaser:

**One (1) Year All Parts and Labor**

This limited warranty begins on the original date of purchase, and is valid only on products purchased and used in the United States. To receive warranty service, the purchaser must contact SAMSUNG for problem determination and service procedures. Warranty service can only be performed by a SAMSUNG authorized service center. The original dated bill of sale and/or proof of delivery must be presented upon request to SAMSUNG or SAMSUNG's authorized service center. SAMSUNG will provide in-home service during the warranty period at no charge, subject to availability within the contiguous United States.

In-home service is not available in all areas.

To receive in-home service, product must be unobstructed and accessible to the service agent. If service is not available, SAMSUNG may elect to provide transportation of the product to and from an authorized service center.

SAMSUNG will repair, replace, or refund this product at our option and at no charge as stipulated herein, with new or reconditioned parts or products if found to be defective during the limited warranty period specified above. All replaced parts and products become the property of SAMSUNG and must be returned to SAMSUNG. Replacement parts and products assume the remaining original warranty, or ninety (90) days, whichever is longer. This limited warranty covers manufacturing defects in materials and workmanship encountered in normal, noncommercial use of this product and shall not apply to the following: damage that occurs in shipment; delivery and installation; applications and uses for which this product was not intended; altered product or serial numbers; cosmetic damage or exterior finish; accidents, abuse, neglect, fire, water, lightning, or other acts of nature or God; use of products, equipment, systems, utilities, services, parts, supplies, accessories, applications, installations, repairs, external wiring or connectors not supplied or authorized by SAMSUNG that damage this product or result in service problems; incorrect electrical line voltage, fluctuations and surges; customer adjustments and failure to follow operating instructions, maintenance and environmental instructions that are covered and prescribed in the instruction book; product removal and reinstallation; problems caused by pest infestations. This limited warranty does not cover problems resulting from electric current, voltage or supply, light bulbs, house fuses, house wiring, cost of a service call for instructions, or fixing installation errors. SAMSUNG does not warrant uninterrupted or error-free operation of the product.

EXCEPT AS SET FORTH HEREIN, THERE ARE NO WARRANTIES ON THIS PRODUCT EITHER EXPRESS OR IMPLIED, AND SAMSUNG DISCLAIMS ALL WARRANTIES INCLUDING, BUT NOT LIMITED TO, ANY IMPLIED WARRANTIES OF MERCHANTABILITY, INFRINGEMENT OR FITNESS FOR A PARTICULAR PURPOSE. NO WARRANTY OR GUARANTEE GIVEN BY ANY PERSON, FIRM, OR CORPORATION WITH RESPECT TO THIS PRODUCT SHALL BE BINDING ON SAMSUNG. SAMSUNG SHALL NOT BE LIABLE FOR LOSS OF REVENUE OR PROFITS, FAILURE TO REALIZE SAVINGS OR OTHER BENEFITS, OR ANY OTHER SPECIAL, INCIDENTAL OR CONSEQUENTIAL DAMAGES CAUSED BY THE USE, MISUSE, OR INABILITY TO USE THIS PRODUCT, REGARDLESS OF THE LEGAL THEORY ON WHICH THE CLAIM IS

WE702NZ Warranty



# Product Overview

## Product Title

Stacking Kit for DV45DG6000HW Heat Pump Dryer and Matching Washer

## Product Description (242 characters)

Save more space in your laundry room by stacking your 6000 Series Washer and Ventless Heat Pump Dryer with this Stacking Kit.\* This kit is compatible with the WF45T6000AW/A5 Front Load Washer and DV45DG6000HWA2 Ventless Heat Pump Dryer.

- Save more space in your laundry room by stacking your 6000 Series Washer and Ventless Heat Pump Dryer with this Stacking Kit.\*
- Securely stacks your dryer on top of your washer.
- Package includes all parts needed for stacking.
- Installation guide included.

\*Compatible with the WF45T6000AW/A5 Front Load Washer and DV45DG6000HWA2 Ventless Heat Pump Dryer.



**Model Number:** SKK-8HK

**UPC:** 887276888132



# Carousel Image Order

Easy Ads links

**Retail.com:** <https://dam.gettyimages.com/p/z0c3461/digital-appliances?o=AND&q=SKK-8HK%20Carousel%20Images%20RCOM>  
**Samsung.com:** <https://dam.gettyimages.com/p/z0c3461/digital-appliances?o=AND&q=SKK-8HK%20Carousel%20Images%20SCOM>

SKK-8HK



# Spec Sheet

## Easy Ads link

<https://dam.gettyimages.com/p/z0c3461/digital-appliances?o=AND&q=SKK-8HK%20Spec%20Sheet>

## SKK-8HK

Stacking Kit for DV45DG6000HW Heat Pump Dryer and Matching Washer

**SAMSUNG**



- Securely stacks your dryer on top of your washer.
- Compatible with Samsung 7.5 cu. ft. Large Capacity Ventless Hybrid Heat Pump Dryer with Wi-Fi and matching washer.
- Package includes all parts needed for stacking.

---

<b>Color</b>	<b>Model #</b>	<b>UPC Code</b>	<b>Product Weight</b>
White	SKK-8HK	887276888132	3.7 lbs
<b>Compatible Models:</b>			<b>Shipping Weight</b>
<b>Washer</b>			4.5 lbs
White	WF45T6000AW	887276394794	<b>Shipping Dimensions (WxHxD)</b>
<b>Heat Pump Dryer</b>			Dimensions: 4 <sup>15</sup> / <sub>16</sub> " x 5 <sup>1</sup> / <sub>16</sub> " x 29 <sup>5</sup> / <sub>16</sub> "
White	DV45DG6000HW	887276886145	

Actual color may vary. Design, specifications, and color availability are subject to change without notice. Non-metric weights and measurements are approximate.  
©2024 Samsung Electronics America, Inc. 85 Challenger Road, Ridgefield Park, NJ 07060. Tel: 800-SAMSUNG, samsung.com. Samsung is a registered trademark of Samsung Electronics Co., Ltd.

SKK-8HK Spec Sheet

# Installation Guide

## Easy Ads link

<https://dam.gettyimages.com/p/z0c3461/digital-appliances?o=AND&q=SKK-8HK%20Installation%20Guide>

EN

## Stacking Kit Installation Guide (SKK-8H\*)

**⚠ CAUTION**

- Risk of personal injury. The dryer is large and heavy. Have at least two people move the dryer. Otherwise, it may result in personal injury or death.
- Risk of product damage during installation. The dryer must be firmly installed on top of the washer. Do not install the washer on top of the dryer. Otherwise, it may result in personal injury, death, or property damage.
- Risk of electric shock. You must disconnect the power cord before installing the product. Otherwise, it may result in severe personal injury or death.
- When installing the dryer on top of the washer, make sure the drain hose in the rear is connected directly to a drain and not to a water tank.

**📌 NOTE**

This Stacking Kit is compatible with Samsung front-load washers and dryers. Check the compatibility of the stacking kit before installing it. You can check the compatible washer and dryer models at the Samsung website ([www.samsung.com](http://www.samsung.com)).

**I. Required tools**

- Crosshead screwdriver <Figure 1>
- Single-face tape <Figure 2>
- Gloves <Figure 3>
- Level <Figure 4>

**II. Accessories**

- Round-head screws (M4 x L16) <Figure 5>
- Flat-head screws (M4 x L16) <Figure 6>
- Round-head screws (M5 x L16) <Figure 7>
- Round stickers <Figure 8>
- Top cover bracket <Figure 9>
- Bracket guide <Figure 10>
- Stacking guide (L/R) <Figure 11>
- Stacking kit installation guide <Figure 12>

**III. Installation**

**STEP 1 <Figure 13>**

Tighten the four levelling feet of the dryer all the way.

- Ensure the dryer is correctly level so it stands balanced evenly on all four feet. A spirit level can assist with this process.
- Connect the drain hose at the back of the dryer directly to your drain system.
- For detailed instructions on connecting the drain hose directly to your drain system, consult the user manual. Electronic copies are available on the Samsung website.

**📌 NOTE**

- For detailed instructions on connecting the drain hose, please check the dryer's user manual.
  - Refer to the figure below when changing the draining method.
  - Make sure to fully insert the drain hose.

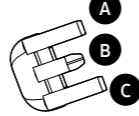

- A.** Do not disassemble
- B.** Water tank drain hose holder (when using direct drain hose)
- C.** Drain water outlet

**STEP 2 <Figure 14>**

Slightly pull out the installed washer to gain access to its rear. Remove the screws from the top cover of the washer.

- Number of fastened screws may differ depending on the model.

**STEP 3 <Figure 15>**

Check the capacity of your washer (22 kg (4.5 cf) and less or 23 kg (5.3 cf) and over) and locate the correct assembly holes on the **stacking guides (A)**.

Max. load of capacity	Models purchased outside of North America	Models purchased in US	Models purchased in Canada
22 kg ↓ 4.5 cf	22 kg and less	4.5 cf and less	5.2 cf and less
23 kg ↑ 5.3 cf	23 kg and over	5.3 cf and over	6.1 cf and over

**STEP 4 <Figure 16>**

Check the washer and the dryer's model names and locate the correct assembly holes on the **top cover brackets (B)**.

**Assembly hole locations based on a model**

Assembly hole type	Washer
<b>A</b>	WF**T****
<b>B</b>	PRE-WF**T**** models

**STEP 5 <Figure 17>**

Install the **top cover brackets (C)** on their corresponding **stacking guides (D)** using the M4 x L16 screws.

- Make sure to check the left and right sides on each accessory before installing them.

**STEP 6 <Figure 18>**

Position the assembled stacking guides on the curved edges of the washer's top cover. Assemble the top cover bracket to designated holes of the washer's rear frame and top cover. Use the provided M5 x L16 screws and the screws that you removed in STEP 2.

**STEP 7 <Figure 19>**

Assemble the bracket guide to the stacking guides at the front end and check the alignment. Remove the release liner from the double-sided tape attached to the bottom of the stacking guides and attach the stacking guides to the washer as shown in the figure. Then, disassemble the bracket guide from the stacking guides.

**⚠ CAUTION**

- Make sure the bottom curvature of the stacking guides is aligned with the curvature of the washer's top cover.
- Attach the stacking guides after making sure they are perfectly parallel with the washer's top cover.
- After attaching the stacking guides, reattach the bracket guide and double check to make sure the stacking guides are parallel.

**STEP 8 <Figure 20>**

Place a protective mat over the front end of the stacking guides to protect the washer.

- Secure the mat in place at the front of the washer using the single-face tapes.

**STEP 9 <Figure 21>**

Use a lift machine or have at least two people lift the dryer and place it on the stacking guide, and then push the dryer until the rear two legs are properly locked into the stacking guides' U-shaped slot.

**STEP 10 <Figure 21>**

Remove the single-face tapes from the sides of the washer and then remove the protective mat.

**STEP 11 <Figure 22>**

If installed correctly, the front edges of the stacking guides should be perfectly aligned with the front edges of the dryer's side frames.

- Check to make sure the front edges of the dryer's side frame are not sticking out past the stacking guides.

**STEP 12 <Figure 23>**

Reattach the bracket guide to the stacking guides and secure it in place using the M4 x L16 flat head screws, as shown in the figure.

**STEP 13 <Figure 24>**

Cover the screws using two of the provided round stickers.

- Use the provided round stickers when installing.

## SKK-8HK Installation Guide



# Product Overview

## Product Title

Less Microfiber™ Filter

## Product Description (291 characters)

Help to protect the planet by reducing the half a million tons of plastic microfibers from laundry that are released into the ocean every year.\* The Less Microfiber™ Filter captures up to 98% of microfibers\*\* released when washing, as they cannot be removed by normal water purification plants.

\*"Fashion's tiny hidden secret", United Nations Environment Programme ([www.unep.org/news-and-stories/story/fashions-tiny-hidden-secret](http://www.unep.org/news-and-stories/story/fashions-tiny-hidden-secret)).

\*\*Captures approximately 89-98%; laboratory tested using 2kg synthetic fabric load in the Samsung washing machine.

- The Less Microfiber™ Filter captures up to 98% of microfibers released when washing<sup>1</sup>.
- Install your Less Microfiber™ Filter in ways<sup>2</sup> to suit your needs and the design of your home.
- Less Microfiber™ filter works effectively without debris clogging for up to 30 uses and allows for easy disposal<sup>3</sup> and reuse.

<sup>1</sup>Captures approximately 89-98%; laboratory tested using 2kg synthetic fabric load in the Samsung washing machine.

<sup>2</sup>Must be installed higher than the washing machine drain.

<sup>3</sup>The captured microfibers should be discarded as general waste and not washed away with water.



**Model Number:** FT-MF/A1

**UPC:** 887276786506

# Product Overview

## Product Title

Less Microfiber™ Filter

## Product Description (291 characters)

Help to protect the planet by reducing the half a million tons of plastic microfibers from laundry that are released into the ocean every year.\* The Less Microfiber™ Filter captures up to 98% of microfibers\*\* released when washing, as they cannot be removed by normal water purification plants.

\*"Fashion's tiny hidden secret", United Nations Environment Programme ([www.unep.org/news-and-stories/story/fashions-tiny-hidden-secret](http://www.unep.org/news-and-stories/story/fashions-tiny-hidden-secret)).

\*\*Captures approximately 89-98%; laboratory tested using 2kg synthetic fabric load in the Samsung washing machine.

- The Less Microfiber™ Filter captures up to 98% of microfibers released when washing<sup>1</sup>.
- Install your Less Microfiber™ Filter in ways<sup>2</sup> to suit your needs and the design of your home.
- Less Microfiber™ filter works effectively without debris clogging for up to 30 uses and allows for easy disposal<sup>3</sup> and reuse.

<sup>1</sup>Captures approximately 89-98%; laboratory tested using 2kg synthetic fabric load in the Samsung washing machine.

<sup>2</sup>Must be installed higher than the washing machine drain.

<sup>3</sup>The captured microfibers should be discarded as general waste and not washed away with water.



**Model Number:** FT-MF/A1

**UPC:** 887276786506



# Carousel Image Order

Easy Ads links

Retail.com: <https://dam.gettyimages.com/p/z0c3461/digital-appliances?o=AND&q=FT-MF%2FA1%20RCOM%20Carousel%20Images>  
Samsung.com: <https://dam.gettyimages.com/p/z0c3461/digital-appliances?o=AND&q=FT-MF%2FA1%20SCOM%20Carousel%20Images>



FT-MF/A1





# Features and Benefits: Less Microfiber™ Filter

<https://dam.gettyimages.com/p/z0c3461/digital-appliances?o=AND&q=FT-MF%2FA1%20Below%20the%20fold> **Easy Ads Link**

Feature Name	Long Body Copy	Short Body Copy	Disclaimer	Associated Image
<p><b>Microplastic Filter</b></p>	<p>Help to protect the planet by reducing the half a million tons of plastic microfibers from laundry that are released into the ocean every year.* The Less Microfiber™ Filter captures up to 98% of microfibers** released when washing, as they cannot be removed by normal water purification plants.</p>	<p>The Less Microfiber™ Filter captures up to 98% of microfibers** released when washing, as they cannot be removed by normal water purification plants.</p>	<p>**“Fashion’s tiny hidden secret”, United Nations Environment Programme (www.unep.org/news-and-stories/story/fashions-tiny-hidden-secret). **Captures approximately 89-98%; laboratory tested using 2kg synthetic fabric load in the Samsung washing machine.</p>	
<p><b>Flexible Installation</b></p>	<p>Install the Less Microfiber™ Filter in ways* to suit your needs and your home. Its cradle can act as a stand or used to mount to the wall.</p>	<p>Install the Less Microfiber™ Filter in ways* to suit your needs and your home. Its cradle can act as a stand or used to mount to the wall.</p>	<p>*Must be installed higher than the washing machine drain.</p>	
<p><b>Easy Filter Cleaning</b></p>	<p>Less Microfiber™ Filter works effectively without debris clogging for up to 30 uses and allows for easy disposal* and reuse.</p>	<p>Less Microfiber™ Filter works effectively without debris clogging for up to 30 uses.</p>	<p>*The captured microfibers should be discarded as general waste and cannot be washed away with water.</p>	

## Features and Benefits: Less Microfiber™ Filter

**Easy Ads Link**  
<https://dam.gettyimages.com/p/z0c3461/digital-appliances?o=AND&q=FT-MF%2FA1%20Below%20the%20fold>

Feature Name	Long Body Copy	Short Body Copy	Disclaimer	Associated Image
<p><b>Wi-Fi Connectivity with SmartThings</b></p>	<p>Wi-Fi Connectivity with SmartThings* allows for easy monitoring of when the filter needs cleaning.</p>	<p>Wi-Fi Connectivity with SmartThings* allows for easy monitoring of when the filter needs cleaning.</p>	<p>*Available on Android and iOS devices. A Wi-Fi connection and a Samsung account are required.</p>	



# Lifestyle Images

## Easy Ads link

<https://dam.gettyimages.com/samsungeasyads/digital-appliances?o=AND&q=FT-MF%2FA1+Lifestyle>

## Hero Lifestyle Image



## Lifestyle Image





# Spec Sheet

## Easy Ads link

<https://dam.gettyimages.com/p/z0c3461/digital-appliances?o=AND&q=FT-MF%2FA1%20Spec%20Sheet>

**FT-MF/A1**
**SAMSUNG**

**Less Microfiber™ Filter**





Help to protect the planet by reducing the half a million tons of plastic microfibers from laundry that are released into the ocean every year. The Less Microfiber™ Filter captures up to 98% of microfibers\*\* released when washing, as they cannot be removed by normal water purification plants.

\* "Fashion's tiny hidden secret", United Nations Environment Programme (www.unep.org/news-and-stories/story/fashions-tiny-hidden-secret).  
\*\* Captures approximately 89-98%, laboratory tested using 2kg synthetic fabric load in the Samsung washing machine.

- Install your Less Microfiber™ Filter in ways<sup>1</sup> to suit your needs and the design of your home.
- Less Microfiber™ Filter works effectively without debris clogging for up to 30 uses and allows for easy disposal<sup>2</sup> and reuse.
- Wi-Fi Connectivity with SmartThings<sup>3</sup> allows for easy monitoring of when the filter needs cleaning.

<sup>1</sup> Must be installed higher than the washing machine drain.  
<sup>2</sup> EU: Available only for drainage pump application models (North America etc.)  
<sup>3</sup> Available on Android and iOS devices. Wi-Fi connection and a Samsung account are required.

---

<b>Model #</b>	<b>UPC Code</b>	<b>Product Dimensions (WxHxD)</b>
FT-MF/A1	887276786506	Dimensions: 3 <sup>9</sup> / <sub>16</sub> " x 8 <sup>7</sup> / <sub>16</sub> " x 11 <sup>1</sup> / <sub>16</sub> "
		<b>Weight</b>
		4.4 lbs
		<b>Shipping Dimensions (WxHxD)</b>
		Dimensions: 13 <sup>7</sup> / <sub>4</sub> " x 11 <sup>1</sup> / <sub>16</sub> " x 11 <sup>1</sup> / <sub>8</sub> "
		<b>Weight</b>
		7.9 lbs

Actual color may vary. Design, specifications, and color availability are subject to change without notice. Non-metric weights and measurements are approximate.  
©2023 Samsung Electronics America, Inc. 85 Challenger Road, Ridgefield Park, NJ 07660. Tel: 800-SAMSUNG, samsung.com. Samsung is a registered trademark of Samsung Electronics Co., Ltd.

## Less Microfiber™ Filter Spec Sheet

# User Manual

## Easy Ads link

<https://dam.gettyimages.com/p/z0c3461/digital-appliances?o=AND&q=FT-MF/A1%20User%20Manual>



FT-MF/A1 User Manual

## Easy Ads link

<https://dam.gettyimages.com/p/z0c3461/digital-appliances?o=AND&q=FT-MF/A1%20Warranty>

### LIMITED WARRANTY (U.S.A)

**Models:**  
FT-MF/A1

#### LIMITED WARRANTY TO ORIGINAL PURCHASER WITH PROOF OF PURCHASE

This SAMSUNG brand product, as supplied and distributed by SAMSUNG ELECTRONICS AMERICA, INC. (SAMSUNG) and delivered new, in the original carton to the original consumer purchaser, is warranted by SAMSUNG against manufacturing defects in materials or workmanship for the limited warranty period, starting from the date of original purchase, of:

#### One (1) year Parts and labor

This limited warranty is valid only on products purchased and used in the United States that have been installed, operated, and maintained according to the instructions attached to or furnished with the product. To receive warranty service, the purchaser must contact SAMSUNG at the address or phone number provided below for problem determination and service procedures. Warranty service can only be performed by a SAMSUNG authorized service center. The original dated bill of sale must be presented upon request as proof of purchase to SAMSUNG or SAMSUNG's authorized service center to receive warranty service.

SAMSUNG will provide in-home service within the contiguous United States during the warranty period at no charge, subject to availability of SAMSUNG authorized servicers within the customer's geographic area. If in-home service is not available, SAMSUNG may elect, at its option, to provide transportation of the product to and from an authorized service center. If the product is located in an area where service by a SAMSUNG authorized servicer is not available, you may be responsible for a trip charge or required to bring the product to a SAMSUNG authorized service center for service.

To receive in-home service, product must be unobstructed and accessible to the service agent.

During the applicable warranty period, a product will be repaired, replaced, or the purchase price refunded, at the sole option of SAMSUNG. SAMSUNG may use new or reconditioned parts in repairing a product, or replace the product with a new or reconditioned product. Replacement parts and products are warranted for the remaining portion of the original product's warranty or ninety (90) days, whichever is longer. All replaced parts and products are the property of SAMSUNG and you must return them to SAMSUNG.

This limited warranty covers manufacturing defects in materials or workmanship encountered in normal household, noncommercial use of this product and shall not cover the following: damage that occurs in shipment, delivery, installation, and uses for which this product was not intended; damage caused by unauthorized modification or alteration of the product; product where the original factory serial numbers have been removed, defaced, changed in any way, or cannot be readily determined; cosmetic damage including scratches, dents, chips, and other damage to the product's finishes; damage caused by abuse, misuse, pest infestations, accident, fire, floods, or other acts of nature or God; damage caused by use of equipment, utilities, services, parts, supplies, accessories, applications, installations, repairs, external wiring or connectors not supplied

FT-MF/A1 Warranty

# Product Overview

## Product Title

Bespoke Stacking and MultiControl™ Combo Kit

## Product Description (352 characters)

Save more space in your laundry room by stacking your Bespoke Washer and Dryer with our Bespoke Stacking and MultiControl™ Combo Kit. Includes a color matching gap cover that fills the space between the washer and dryer when stacking to create an even and flush look. This kit is compatible with the color matched Bespoke Front Load washers and dryers.

- Save more space in your laundry room by stacking your Bespoke Washer and Dryer with our Bespoke Stacking and MultiControl™ Combo Kit.
- Securely stacks your dryer on top of your washer.
- Includes a gap cover that fills the space between the washer and dryer when stacking to create an even and flush look.
- This kit is compatible with our Bespoke Front Load washers and dryers.
- Package includes all parts needed for stacking and MultiControl™ use.

## Available Colors



### Silver Steel

**Model Number:** SKK-9MCT

**UPC:** 887276667379

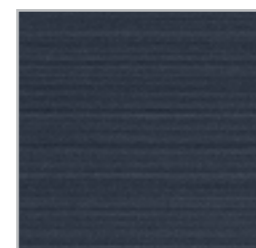

### Brushed Navy

**Model Number:** SKK-9MCD

**UPC:** 887276667362



### Brushed Black

**Model Number:** SKK-9MCV

**UPC:** 887276667386



### Forest Green

**Model Number:** SKK-9MCG

**UPC:** 887276712819





# Carousel Image Order

Easy Ads links

**Retail.com:** <https://dam.gettyimages.com/p/z0c3461/digital-appliances?o=AND&q=SKK-9MCT%20RCOM>  
**Samsung.com:** <https://dam.gettyimages.com/p/z0c3461/digital-appliances?o=AND&q=SKK-9MCT%20SCOM>

SKK-9MCT Silver Steel



# Carousel Image Order

Easy Ads links

**Retail.com:** <https://dam.gettyimages.com/p/z0c3461/digital-appliances?o=AND&q=SKK-9MCD%20RCOM>  
**Samsung.com:** <https://dam.gettyimages.com/p/z0c3461/digital-appliances?o=AND&q=SKK-9MCD%20SCOM>

SKK-9MCD Brushed Navy



# Carousel Image Order

Easy Ads links

**Retail.com:** <https://dam.gettyimages.com/p/z0c3461/digital-appliances?o=AND&q=SKK-9MVC%20RCOM>  
**Samsung.com:** <https://dam.gettyimages.com/p/z0c3461/digital-appliances?o=AND&q=SKK-9MVC%20SCOM>

SKK-9MVC Brushed Black





# Carousel Image Order

Easy Ads links

**Retail.com:** <https://dam.gettyimages.com/p/z0c3461/digital-appliances?o=AND&q=SKK-9MCG%20RCOM>  
**Samsung.com:** <https://dam.gettyimages.com/p/z0c3461/digital-appliances?o=AND&q=SKK-9MCG%20SCOM>

SKK-9MCG Forest Green



# Compatible Models

Model Number	Type	Color
DVE53BB8900T	Bespoke Electric Dryer	Silver Steel
DVE53BB8900D	Bespoke Electric Dryer	Brushed Navy
DVE53BB8900G	Bespoke Electric Dryer	Forest Green
DVE53BB8700T	Bespoke Electric Dryer	Silver Steel
DVE53BB8700V	Bespoke Electric Dryer	Brushed Black
DVG53BB8900T	Bespoke Gas Dryer	Silver Steel
DVG53BB8900D	Bespoke Gas Dryer	Brushed Navy
DVG53BB8900G	Bespoke Gas Dryer	Forest Green
DVG53BB8700T	Bespoke Gas Dryer	Silver Steel
DVG53BB8700V	Bespoke Gas Dryer	Brushed Black
WF53BB8900AT	Bespoke Front Load Washer	Silver Steel
WF53BB8900AD	Bespoke Front Load Washer	Brushed Navy
WF53BB8900AG	Bespoke Front Load Washer	Forest Green
WF53BB8700AT	Bespoke Front Load Washer	Silver Steel
WF53BB8700AV	Bespoke Front Load Washer	Brushed Black



# Spec Sheet

## Easy Ads link

<https://dam.gettyimages.com/p/z0c3461/digital-appliances?o=AND&q=SKK-9MC%20Spec%20Sheet>

## SKK-9MC

Bespoke Stacking and MultiControl™ Combo Kit

- Securely stacks your dryer on top of your washer.
- Includes a gap cover in matching Bespoke color that fills the space between the washer and dryer when stacking to create a seamless and flush look.
- This kit is compatible with our matching color Bespoke Front Load washers and dryers.
- Package includes all parts needed for stacking and MultiControl™ use.

---

**Compatible Models:**

Electric Dryer	Model #	UPC Code	Bespoke Color	Model #	UPC Code
Silver Steel	DVE53BB8900T	887276657264	Silver Steel Stacking Kit	SKK-9MCT	887276667379
Brushed Navy	DVE53BB8900D	887276657257	Brushed Navy Stacking Kit	SKK-9MCD	887276667362
Forest Green	DVE53BB8900G	887276711645	Brushed Black Stacking Kit	SKK-9MCMV	887276667386
Silver Steel	DVE53BB8700T	887276657233	Forest Green Stacking Kit	SKK-9MCG	887276712819
Brushed Black	DVE53BB8700V	887276657240			

Gas Dryer	Model #	UPC Code
Silver Steel	DVG53BB8900T	887276657325
Brushed Navy	DVG53BB8900D	887276657318
Forest Green	DVG53BB8900G	887276711669
Silver Steel	DVG53BB8700T	887276657295
Brushed Black	DVG53BB8700V	887276657301

Washer	Model #	UPC Code
Silver Steel	WF53BB8900AT	887276652269
Brushed Navy	WF53BB8900AD	887276652252
Forest Green	WF53BB8900AG	887276711881
Silver Steel	WF53BB8700AT	887276652238
Brushed Black	WF53BB8700AV	887276652245

**Product Weight**  
4.7 lbs

**Shipping Weight**  
5.5 lbs

**Shipping Dimensions (WxHxD)**  
Dimensions: 4<sup>9</sup>/<sub>16</sub>" x 5<sup>5</sup>/<sub>16</sub>" x 29<sup>9</sup>/<sub>16</sub>"

Actual color may vary. Design, specifications, and color availability are subject to change without notice. Non-metric weights and measurements are approximate.  
©2022 Samsung Electronics America, Inc. 85 Challenger Road, Ridgefield Park, NJ 07660. Tel: 800-SAMSUNG, samsung.com. Samsung is a registered trademark of Samsung Electronics Co., Ltd.

## Bespoke Stacking and MultiControl™ Combo Kit



# Installation Video

## Easy Ads link

<https://dam.gettyimages.com/p/z0c3461/digital-appliances?o=AND&q=Stacking%20and%20MultiControl%20Combo%20Kit%20Video>



# User Manual

## Easy Ads link

<https://dam.gettyimages.com/p/z0c3461/digital-appliances?o=AND&q=SKK-9MC%20User%20Manual>

### Stacking Kit Installation Guide (SKK-9MC\*)



DC68-03859G-00

#### CAUTION

- Risk of personal injury. The dryer is large and heavy. Have at least two people move the dryer. Otherwise, it may result in personal injury or death.
- Risk of product damage during installation. The dryer must be firmly installed on top of the washer. Do not install the washer on top of the dryer. Otherwise, it may result in personal injury, death, or property damage.
- Risk of electric shock. You must disconnect the power cord before installing the product. Otherwise, it may result in severe personal injury or death.
- When installing the dryer on top of the washer, make sure the drain hose in the rear is connected directly to a drain and not to a water tank.

#### NOTE

This Stacking Kit is compatible with Samsung BESPOKE front-load washers and dryers released after 2022. Check the compatibility of the stacking kit before installing it. You can check the compatible washer and dryer models at the Samsung website ([www.samsung.com](http://www.samsung.com)).

#### Accessories

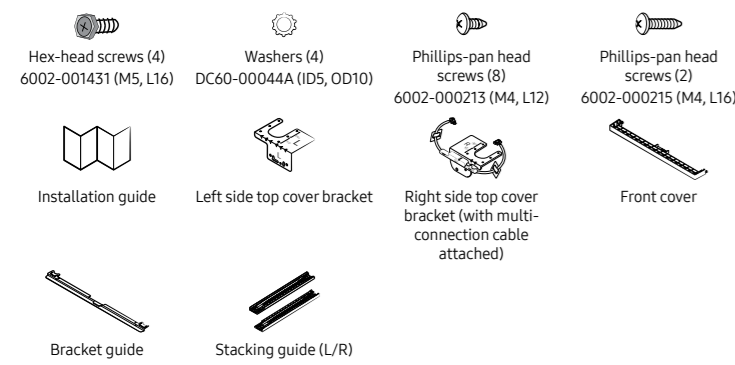

#### Installation

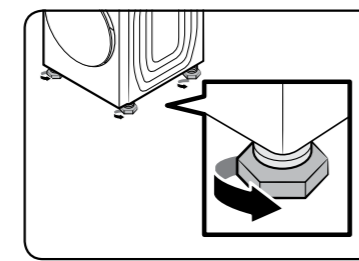

#### STEP 1

- Tighten the four leveling feet of the dryer all the way.
- Level the dryer using a level.

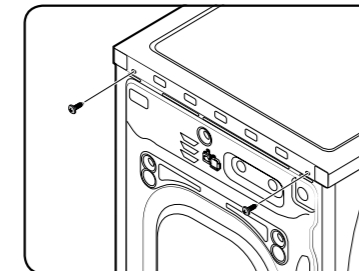

#### STEP 2

- Slightly pull out the installed washer to gain access to its rear.
- Unfasten the two screws attached at the back of the washer.

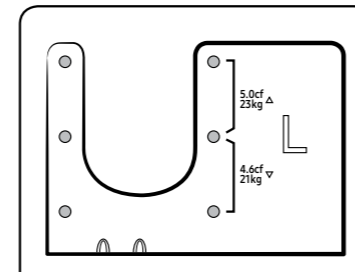

#### STEP 3

- Check the capacity of your washer (5.0 cf and over or 4.6 cf and less) and locate the correct assembly holes on the top cover bracket (L/R).

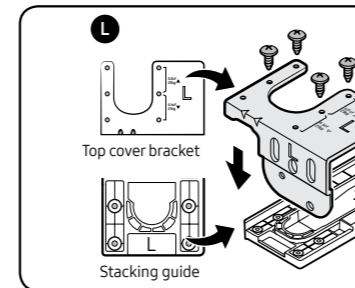

#### STEP 4

- Fasten the top cover brackets (L/R) to their corresponding stacking guides (L/R) using four M4 x L12 Phillips-Pan head screws.
- Check and make sure each top cover brackets are on the correct sides (left/right) of the stacking guides before fastening them.

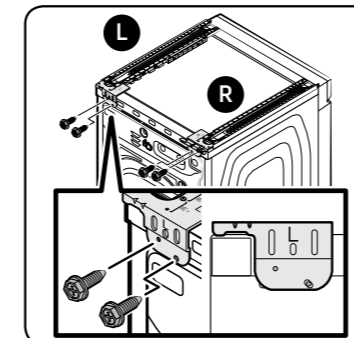

#### STEP 5

- Position the assembled stacking guides (L/R) on the curved edges of the washer's top cover. Fasten the assembled stacking guides (L/R) using four washers and M5 x L16 hex-head screws.

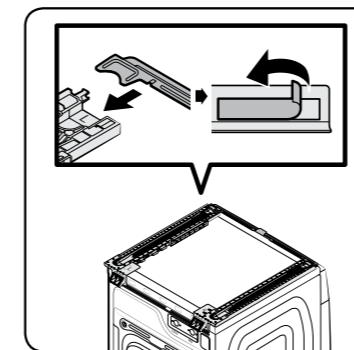

#### STEP 6

- Assemble the bracket guide to the stacking guides at the front end and check the alignment. Remove the release liner from the double-sided tape attached to the bottom of the stacking guides and attach the stacking guides to the washer as shown in the figure. Then, disassemble the bracket guide from the stacking guides.

#### CAUTION

- Make sure the bottom curvature of the stacking guide is aligned with the curvature of the washer's top cover.
- Attach the stacking guides after making sure they are perfectly parallel with the washer's top cover.
- After attaching the stacking guides, reattach the bracket guide and double-check to make sure the stacking guides are parallel.

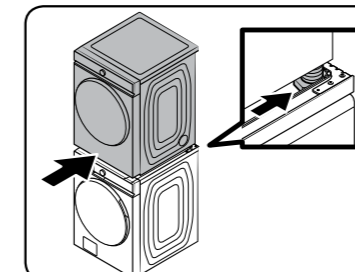

#### STEP 7

- Have at least two people lift the dryer and place it on the stacking guide, and then push the dryer until the rear two legs are properly locked into the stacking guides' U-shaped slot.

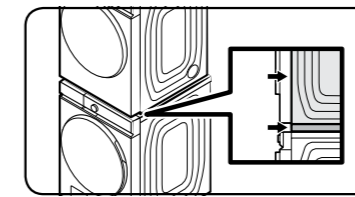

#### STEP 8

- If installed correctly, the front edges of the stacking guides should be perfectly aligned with the front edges of the dryer's side frames.
- Check to make sure the front edges of the dryer's side frame are not sticking out past the stacking guides.

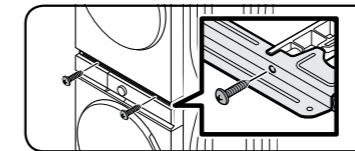

#### STEP 9

- Attach the bracket guide to the stacking guides and secure it in place using the M4 x L16 Phillips-Pan head screws, as shown in the figure.

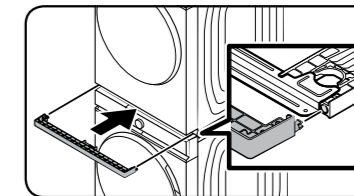

#### STEP 10

- Hold the front cover with the letter 'UP' facing upward. Align the hooks on the front cover with the holes on the stacking guides as shown in the figure. Then, fully insert the hooks to attach the front cover to the staking guides.

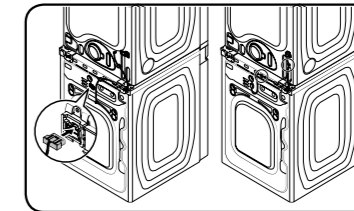

#### STEP 11

- Open the connector port covers on the dryer and the washer. Then, connect the multi-connection cable on both ports and close both connector port covers. Attach each wire holder to the designated slots on the dryer and the washer.

# Product Overview

## Product Title

Bespoke Heat Pump Stacking and MultiControl™ Combo Kit

## Product Description (428 characters)

Save more space in your laundry room by stacking your Bespoke Washer and Bespoke Ventless Hybrid Heat Pump Dryer with our Bespoke Heat Pump Stacking & MultiControl™ Combo Kit. Includes a color matching gap cover that fills the space between the washer and dryer when stacking to create an even and flush look. This kit is compatible with the color matched Bespoke Front Load washers and Bespoke Ventless Hybrid Heat Pump dryers.

- Save more space in your laundry room by stacking your Bespoke Washer and Bespoke Ventless Hybrid Heat Pump Dryer with our Bespoke Heat Pump Stacking and MultiControl™ Combo Kit.
- Securely stacks your dryer on top of your washer.
- Includes a gap cover that fills the space between the washer and dryer when stacking to create an even and flush look.
- This kit is compatible with our Bespoke Front Load washers and Bespoke Ventless Hybrid Heat Pump dryers.
- Package includes all parts needed for stacking and MultiControl™ use.

## Available Color



**Brushed Navy**

**Model Number:** SKK-9ALD

**UPC:** 8872766722054

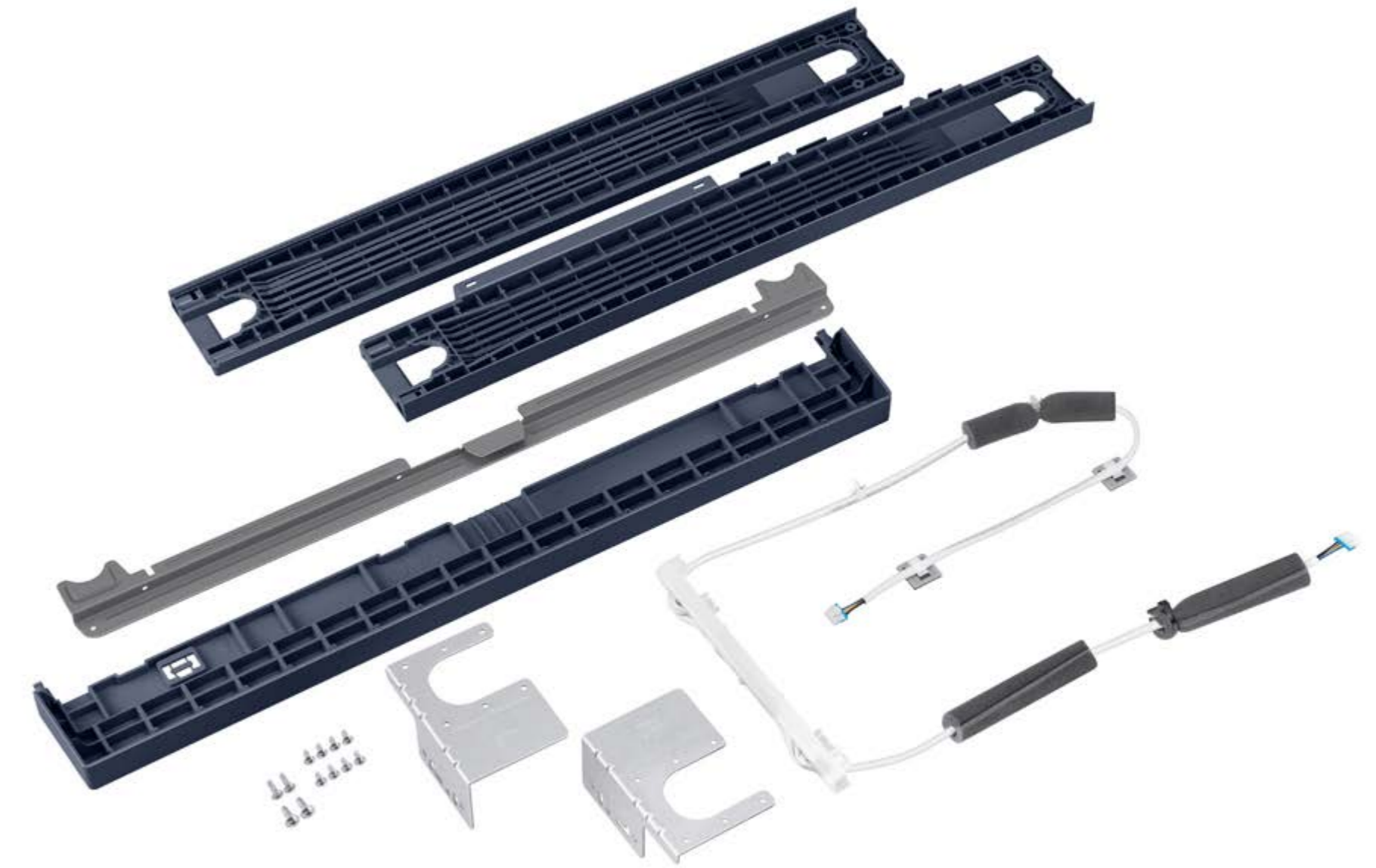



# Carousel Image Order

Easy Ads links

**Retail.com:** <https://dam.gettyimages.com/p/z0c3461/digital-appliances?o=AND&q=SKK-9ALD%20RCOM>  
**Samsung.com:** <https://dam.gettyimages.com/p/z0c3461/digital-appliances?o=AND&q=SKK-9ALD%20SCOM>

SKK-9ALD Brushed Navy



# Spec Sheet



## Easy Ads link

<https://dam.gettyimages.com/p/z0c3461/digital-appliances?o=AND&q=SKK-9ALD%20Spec%20Sheet>

## SKK-9ALD

Bespoke Heat Pump Stacking & MultiControl™ Combo Kit

**SAMSUNG**

Save more space in your laundry room by stacking your Bespoke Washer and Heat Pump Dryer with our Bespoke Heat Pump Stacking and MultiControl™ Combo Kit. Includes a color matching gap cover that fills the space between the washer and dryer when stacking to create an even and flush look. This kit is compatible with the color matched Bespoke Front Load washers and Heat Pump dryers.

- Save more space in your laundry room by stacking your Bespoke Washer and Heat Pump Dryer with our Bespoke Heat Pump Stacking and MultiControl™ Combo Kit.
- Securely stacks your dryer on top of your washer.
- Includes a gap cover that fills the space between the washer and dryer when stacking to create an even and flush look.
- This kit is compatible with our Bespoke Front Load washers and Heat Pump dryers.
- Package includes all parts needed for stacking and MultiControl™ use.

---

Compatible Models:			Model #	UPC Code
<b>Heat Pump Dryer</b>	<b>Model #</b>	<b>UPC Code</b>	SKK-9ALD	887276722054
Brushed Navy	DV53BB8900HD	887276716268		
<b>Washer</b>	<b>Model #</b>	<b>UPC Code</b>	<b>Product Weight</b>	<b>Shipping Weight</b>
Brushed Navy	WF53BB8900AD	88727665252	4.74 lbs	5.07 lbs
			<b>Shipping Dimensions (WxHxD)</b>	
			Dimensions: 6 <sup>3</sup> / <sub>16</sub> " x 27 <sup>1</sup> / <sub>16</sub> " x 22 <sup>7</sup> / <sub>16</sub> "	

Actual color may vary. Design, specifications, and color availability are subject to change without notice. Non-metric weights and measurements are approximate.  
©2022 Samsung Electronics America, Inc. 85 Challenger Road, Ridgefield Park, NJ 07660. Tel: 800-SAMSUNG, samsung.com. Samsung is a registered trademark of Samsung Electronics Co., Ltd.

Bespoke Heat Pump Stacking and MultiControl™ Combo Kit

# Product Overview

## Product Title

Samsung MultiControl™ & Stacking Kit

## Product Description (331 characters)

Stack select Samsung front load pairs and eliminate the long reach by operating your dryer right from your washer. The Samsung SKK-8MC Laundry MultiControl™ & Stacking Kit is compatible with front load washers and dryers that include the MultiControl™ feature. Package includes all parts needed for stacking and MultiControl™ use.

- Enables control of the dryer right from the washer when stacking select Samsung Front Load pairs.
- Compatible with models that include the MultiControl™ feature.
- Includes all parts needed to stack and use MultiControl™ feature.

**Model Number:** SKK-8MC

**UPC:** 887276597959

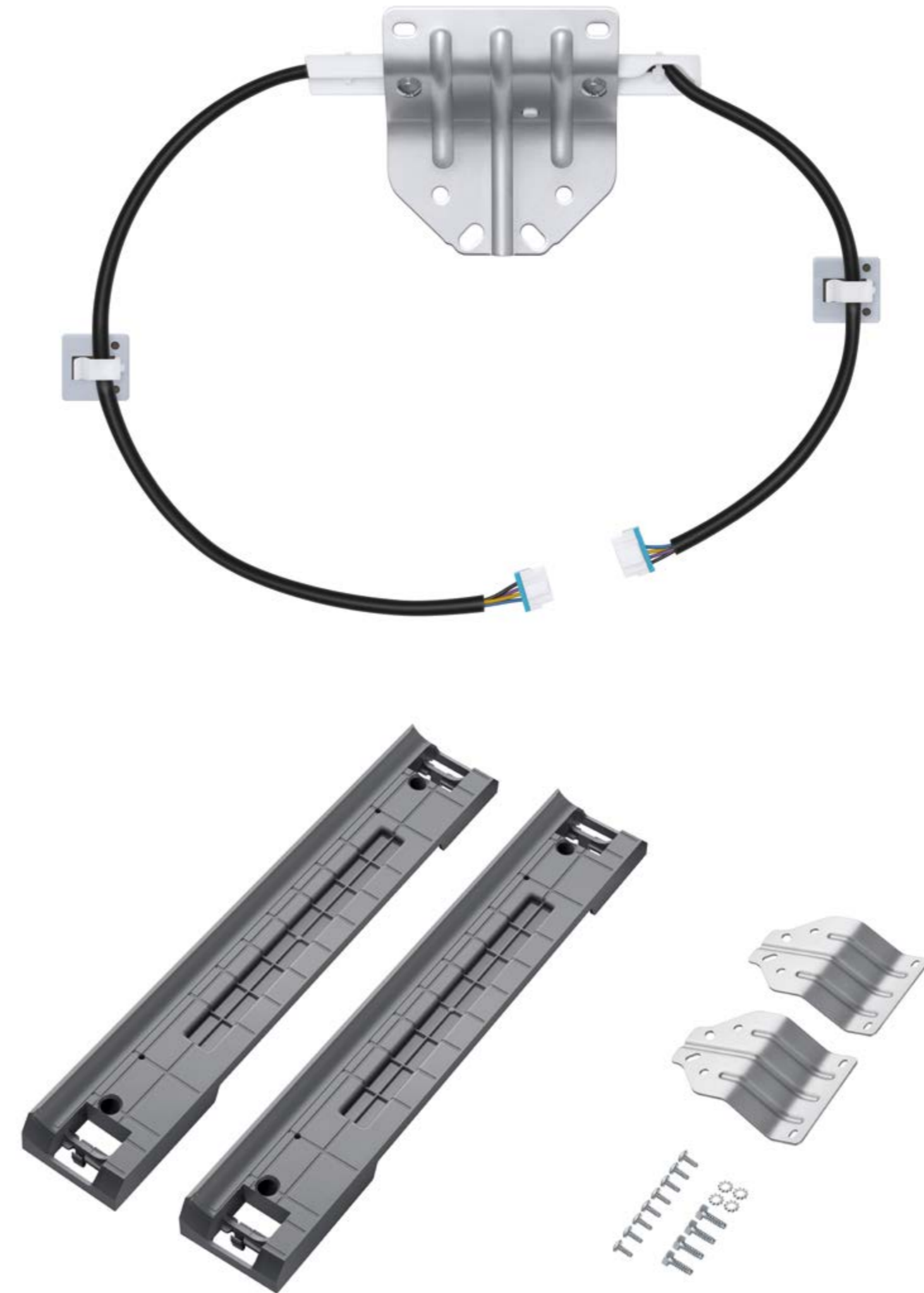



# Carousel Image Order

Easy Ads links

Retail.com: <https://dam.gettyimages.com/p/z0c3461/digital-appliances?o=AND&q=SKK-8MC%20RCOM>  
Samsung.com: <https://dam.gettyimages.com/p/z0c3461/digital-appliances?o=AND&q=SKK-8MC%20SCOM>

SKK-8MC



# Spec Sheet

## Easy Ads link

<https://dam.gettyimages.com/p/z0c3461/digital-appliances?o=AND&q=SKK-8MC%20Spec%20Sheet>

## SKK-8MC

Samsung MultiControl™ & Stacking Kit

Stack select Samsung front load pairs and eliminate the long reach by operating your dryer right from your washer. The Samsung SKK-8MC Laundry MultiControl™ & Stacking kit is compatible with front load washers and dryers that include the MultiControl™ feature. Package includes all parts needed for stacking and MultiControl™ use.

- Enables control of the dryer right from the washer when stacking select Samsung Front load pairs.
- Compatible with models that include the MultiControl™ feature.
- Includes all parts needed to stack and use MultiControl™ feature.

Compatible Models:		
Electric Dryer	Model #	UPC Code
Brushed Black	DVE50A8800V	887276517735
Brushed Black	DVE50A8600V	887276517728
Ivory	DVE50A8600E	887276521558
Brushed Black	DVE45A6400V	887276557700
White	DVE45A6400W	887276557717
Gas Dryer	Model #	UPC Code
Brushed Black	DVG50A8800V	887276521565
Brushed Black	DVG50A8600V	887276517759
Ivory	DVG50A8600E	887276517742
Brushed Black	DVG45A6400V	887276557779
White	DVG45A6400W	887276557786
Matching Washer	Model #	UPC Code
Brushed Black	WF50A8800AV	887276519012
Brushed Black	WF50A8600AV	887276519005
Ivory	WF50A8600AE	887276518992
Brushed Black	WF45A6400AV	887276557861
White	WF45A6400AW	887276557878

Model #	UPC Code
SKK-8MC	887276597959
SKK-8MC (Case Pack)	10887276597956
<b>Product Weight</b>	
2.65 lbs	
<b>Shipping Weight</b>	
3.08 lbs	
<b>Shipping Dimensions (WxHxD)</b>	
Dimensions: 6 15/16" x 2 7/16" x 22 7/8"	

Actual color may vary. Design, specifications, and color availability are subject to change without notice. Non-metric weights and measurements are approximate.

©2021 Samsung Electronics America, Inc. 85 Challenger Road, Ridgefield Park, NJ 07660.  
Tel: 800-SAMSUNG, samsung.com. Samsung is a registered trademark of Samsung Electronics Co., Ltd.

## Samsung MultiControl™ & Stacking Kit Spec Sheet

# User Manual

## Easy Ads link

<https://dam.gettyimages.com/p/z0c3461/digital-appliances?o=AND&q=SKK-8MC%20User%20Manual>

**STACKING+MULTI CONTROL KIT INSTALLATION INSTRUCTIONS (WASHER & DRYER ONLY)**  
**CONSIGNES D'INSTALLATION DU KIT MULTI-CONTROLÉ ET DU KIT DE SUPERPOSITION (LAVE-LINGE ET SÈCHE-LINGE UNIQUEMENT) / INSTRUCCIONES DE INSTALACIÓN DEL KIT DE APILAMIENTO Y DEL KIT DE CONTROL MÚLTIPLE (LAVADORA Y SECADORA ÚNICAMENTE)**

**CAUTION:** Two people are required to lift the dryer on to the washer.  
**WARNING:** These washer and dryer are not suitable for mobile home or RV installation.

**Dryer**

**STEP 1** Have two persons place the dryer on a non-slippery floor. Then have one person tilt the dryer to the side. Do not lay the dryer down. The dryer may be scratched.

**STEP 2** Check to make sure the legs are all the way up and tightened securely in place. And then insert the stacking support guides in the rectangular holes of the dryer's base until you hear a clicking sound. You don't need to remove the legs.

**STEP 3** Repeat the same step above on the other side.

**STEP 4** Bottom view of the dryer after assembling the Stacking Support Guides to the dryer base.  
 \* Use a stacking-kit compatible with the purchased model.  
 \* Do not lay the dryer down on a floor when installing the stacking kit. Hold the dryer firmly to prevent it from tipping over.

**Washer (only applicable for models supporting multi-control)**

**STEP 5** **DO NOT TIGHTEN SCREWS COMPLETELY. LOOSELY** install two REAR BRACKETS at the back of the washer using the two SCREWS-HEX HEAD (6002-001431) and WASHERS (DC60-00044A).

1. Fasten the ASSY BRACKET STACKING on the right side.
2. Fasten the other REAR BRACKET on the left side.

**STEP 6** Lift and position dryer into the position on the washer shown above, slide dryer backwards to make contact with rear brackets.

**CAUTION:** To prevent noise, check the followings.  
 • Make sure the washer is level.  
 • Make sure the dryer's leveling legs are tightened up.

**STEP 7** Align rear brackets with mounting holes on the rear of dryer as shown above.

**STEP 8** **LOOSELY assemble** rear brackets to the back of the dryer using two (2) Screws-Phillips Pan Head (6006-001174) for each rear bracket as shown above.  
 Extra screws may be included with this kit.

**STEP 9** Tighten screws on the dryer side of the rear bracket.  
**WARNING:** Additional gas hook-up components are required for gas dryer.

**STEP 10** Tighten screws on the washer side of the rear bracket.  
 \* DO NOT REVERSE THE ORDER OF STEPS 8 & 9.

**STEP 11** Assemble the provided ASSY BRACKET STACKING on the right side and assemble the REAR BRACKET on the left side. All the necessary parts are included in the stacking kit.

**STEP 12** Open the connector port cover on the dryer and the washer, connect the wire on both ports, and then close the cover.  
 • Be careful not to damage the wire by the connector port cover.  
 • Do not pull the wire too hard to remove the connector from the port.

**STEP 13** There are two HOLDER WIRE pre-assembled to the wire. Attach each HOLDER WIRE to the dryer and the washer. Check and make sure the washer and the dryer are connected.

**Stacking kit components**

Stacking Support Guides (2) DC61-04159A Stacking Support Guides (2) - DC61-01480B	Rear Bracket (1) (All models other than the ones using DC61-04160A part) - DC61-04955A	Screw-Hex Head (4) - 6009-001476 (MS, L12) - 6002-001431 (MS, L18)
Screw-Phillips Pan Head (8) - 6006-001174 (M4, L12)	Washer (4) - DC60-00044A (DPS, OD10)	Assy Bracket Stacking (1)

**ATTENTION:** Il faut deux personnes pour soulever le sèche-linge par-dessus le lave-linge.  
**AVERTISSEMENT:** ce lave-linge et ce sèche-linge ne conviennent pas à une installation en mobile home ou VR.

**Sèche-linge**

**ÉTAPE 1** Demandez à deux personnes de placer le sèche-linge sur une surface antidérapante. Ensuite, demandez à une personne d'incliner le sèche-linge sur le côté. Ne laissez pas le sèche-linge au sol. Vous risqueriez de rayer le sèche-linge.

**ÉTAPE 2** Vérifiez que les pieds sont bien à la verticale et solidement serrés en place. Ensuite, insérez les guides de support de superposition dans les orifices rectangulaires à la base du sèche-linge jusqu'à entendre un « clic ». Vous n'avez pas besoin de retirer les pieds.

**ÉTAPE 3** Répétez l'étape ci-dessus de l'autre côté.

**ÉTAPE 4** Vue de dessous du sèche-linge après installation des guides du support de superposition à la base du sèche-linge.  
 \* Utilisez un kit de superposition compatible avec le modèle acheté.  
 \* Ne laissez pas le sèche-linge au sol lors de l'installation du kit de superposition. Maintenez fermement le sèche-linge pour éviter qu'il ne bascule.

**Lave-linge (uniquement applicable aux modèles prenant en charge le kit multi-controlé)**

**ÉTAPE 5** **NE SERREZ PAS COMPLÈTEMENT LES VIS. SANS SERRER,** fixez les deux SUPPORTS ARRIÈRE à l'arrière du lave-linge à l'aide des deux VIS À TÊTE HEXAGONALE (6002-001431) et RONDELLES (DC60-00044A).

1. Fixez l'ENSEMBLE DU SUPPORT DE SUPERPOSITION sur le côté droit.
2. Fixez l'autre SUPPORT ARRIÈRE sur le côté gauche.

**ÉTAPE 6** Soulevez et mettez le sèche-linge en place sur le lave-linge indiqué ci-dessus, faites glisser le sèche-linge vers l'arrière pour entrer en contact avec les supports arrière.

**ATTENTION:** Pour éviter le bruit, vérifiez ce qui suit.  
 • Assurez-vous que le lave-linge est de niveau.  
 • Assurez-vous que les pieds de mise à niveau du sèche-linge sont bien serrés.

**ÉTAPE 7** Alignez les supports arrière avec les orifices de montage à l'arrière du sèche-linge, comme indiqué ci-dessus.

**ÉTAPE 8** **SANS SERRER,** installez les supports arrière à l'arrière du sèche-linge à l'aide de deux (2) vis Phillips à tête cylindrique (6006-001174) pour chaque support arrière, comme indiqué ci-dessus. Il se peut que des vis supplémentaires aient été fournies avec ce kit.

## Samsung MultiControl™ & Stacking Kit User Manual



# Product Overview

## Product Title

Bespoke 27" Wide Laundry Pedestal with Storage Drawer

## Product Description (295 characters)

Designed to pair with Samsung Bespoke Front Load washers and dryers, this 27" wide pedestal will allow you to lift your Bespoke washer or dryer by more than a foot for a more convenient height. It also provides an easily accessible built-in storage drawer, so you can tidy up your laundry space.

- Beautiful, flat panel design creates a seamless, integrated look with any Bespoke laundry set.
- Compatible with Samsung Bespoke 27" wide Front Load washers and dryers.
- Elevates your washer and dryer by more than a foot, for easier loading and unloading – no more bending.
- Provides an easily accessible storage drawer for your laundry cleaning supplies.



## Available Colors



### Silver Steel

**Model Number:** WE502NT

**UPC:** 887276665283



### Brushed Navy

**Model Number:** WE502ND

**UPC:** 887276665276



### Brushed Black

**Model Number:** WE502NV

**UPC:** 887276665290



### Forest Green

**Model Number:** WE502NG

**UPC:** 887276711676

# Carousel Image Order

Easy Ads links

Retail.com: <https://dam.gettyimages.com/p/z0c3461/digital-appliances?o=AND&q=WE502NT%20carousel%20images%20rcom>  
Samsung.com: <https://dam.gettyimages.com/p/z0c3461/digital-appliances?o=AND&q=WE502NT%20carousel%20images%20scom>

WE502NT Silver Steel



Image provided in decimals and fractions.



# Carousel Image Order

Easy Ads links

Retail.com: <https://dam.gettyimages.com/p/z0c3461/digital-appliances?o=AND&q=WE502ND%20carousel%20images%20rcom>  
Samsung.com: <https://dam.gettyimages.com/p/z0c3461/digital-appliances?o=AND&q=WE502ND%20carousel%20images%20scom>

WE502ND Brushed Navy



Image provided in decimals and fractions.





# Carousel Image Order

Easy Ads links

Retail.com: <https://dam.gettyimages.com/p/z0c3461/digital-appliances?o=AND&q=WE502NV%20carousel%20images%20com>  
Samsung.com: <https://dam.gettyimages.com/p/z0c3461/digital-appliances?o=AND&q=WE502NV%20carousel%20images%20scom>

WE502NV Brushed Black



Image provided in decimals and fractions.



# Carousel Image Order

Easy Ads links

Retail.com: <https://dam.gettyimages.com/p/z0c3461/digital-appliances?o=AND&q=WE502NG%20carousel%20images%20rcom>  
Samsung.com: <https://dam.gettyimages.com/p/z0c3461/digital-appliances?o=AND&q=WE502NG%20carousel%20images%20scom>

WE502NG Forest Green



Image provided in decimals and fractions.



# Lifestyle Image

## Easy Ads link

<https://dam.gettyimages.com/p/z0c3461/digital-appliances?o=AND&q=WE502ND%20Lifestyle%20Images>

## Lifestyle Image







# Spec Sheet

## Easy Ads link

[https://dam.gettyimages.com/p/z0c3461/digital-appliances?o=AND&q=WE502N\\*%20spec%20sheet](https://dam.gettyimages.com/p/z0c3461/digital-appliances?o=AND&q=WE502N*%20spec%20sheet)

WE502N
SAMSUNG

Bespoke 27" Laundry Pedestal with Storage Drawer

**Signature Features:**

- Beautiful, flat panel design creates a seamless, integrated look with any Bespoke laundry set.
- Compatible with Samsung Bespoke 27" wide Front Load washers and dryers.
- Elevates your washer and dryer by more than a foot, for easier loading and unloading – no more bending.
- Provides an easily accessible storage drawer for your laundry cleaning supplies.

**Available Colors**

	Silver Steel	
	Brushed Black	
	Brushed Navy	
	Forest Green	

<b>Product Dimensions &amp; Weight (WxHxD)</b>	<b>Color</b>	<b>Model #</b>	<b>UPC Code</b>
Dimensions: 27" x 15" x 29"	Silver Steel	WE502NT	887276665283
Weight: 45.9 lbs	Brushed Black	WE502NV	887276665290
	Brushed Navy	WE502ND	887276665276
	Forest Green	WE502NG	887276711676
<b>Shipping Dimensions &amp; Weight (WxHxD)</b>	<b>Warranty</b>		
Dimensions: 30" x 16 <sup>13</sup> / <sub>16</sub> " x 32 <sup>13</sup> / <sub>16</sub> "	One (1) Year Parts and Labor		
Weight: 52.7 lbs			

Actual color may vary. Design, specifications, and color availability are subject to change without notice. Non-metric weights and measurements are approximate.  
©2022 Samsung Electronics America, Inc. 85 Challenger Road, Ridgefield Park, NJ 07660. Tel. 800-SAMSUNG, samsung.com. Samsung is a registered trademark of Samsung Electronics Co., Ltd.

## Bespoke Pedestal Spec Sheet

# Installation Guides

## Easy Ads link

<https://dam.gettyimages.com/p/z0c3461/digital-appliances?o=AND&q=WE502N%20user%20guide>

## Easy Ads link

<https://dam.gettyimages.com/p/z0c3461/digital-appliances?o=AND&q=WE402NE%20user%20guide>

### Adjusting the height of the dryer/Regular la altura de la secadora/Ajustement de la hauteur du sèche-linge

**Step 1. Loosen the 4 locking clamps of the clamp-type pedestal**

- Open the clamp-type pedestal drawer.
- Unscrew the screws fastening the locking clamps. (1 per clamp)

**Paso 1. Afloje las 4 abrazaderas de fijación del pedestal con abrazadera**

- Abra el cajón del pedestal con abrazadera.
- Afloje el tornillo que ajusta la abrazadera de fijación. (1 por abrazadera)

**Étape 1. Desserrer les 4 brides de fixation du socle à brides**

- Ouvrez le tiroir du socle à brides.
- Dévissez la vis qui maintient la bride de fixation en place. (1 par bride)

**Step 2. Raise the height of the dryer**

Fully retract the dryer's leveling feet and then turn them counterclockwise 4 turns so that the dryer is the same height as the washer.

**Paso 2. Subir la altura de la secadora**

Retraiga completamente las patas niveladoras de la secadora y luego gírelas hacia la izquierda 4 vueltas para que la secadora quede a la misma altura que la lavadora.

**Étape 2. Relever le sèche-linge**

Rétractez complètement les pieds réglables du sèche-linge, puis tournez-les sur 4 tours dans le sens antihoraire afin que la hauteur du sèche-linge soit identique à celle du lave-linge.

**Step 3. Tighten the 4 locking clamps of the clamp-type pedestal**

Close the locking clamps and then fasten each clamp with a screw.

**Paso 3. Ajuste las 4 abrazaderas de fijación del pedestal con abrazadera**

Cierre las abrazaderas de fijación y luego ajuste cada abrazadera con un tornillo.

**Étape 3. Serrer les 4 brides de fixation du socle à brides**

Fermez les brides de fixation, puis serrez chaque bride à l'aide de la vis.

**Step 4. Do a final check**

- Use a bubble level to make sure the dryer is level.
- Make sure the water connections, gas connections, electrical connections, and venting are secured.
- Run a test cycle to ensure proper operation.

**Paso 4. Verificación final**

- Use un nivel de burbuja de aire para asegurarse de que la secadora esté nivelada.
- Asegúrese de que las conexiones de agua, las conexiones de gas, las conexiones eléctricas y ventilaciones estén fijadas.
- Ejecute un ciclo de prueba para garantizar un funcionamiento seguro.

**Étape 4. Dernière vérification**

- Utilisez un niveau à bulle pour vérifier que le sèche-linge est bien de niveau.
- Assurez-vous que les raccordements d'eau, de gaz, électriques et de ventilation sont bien effectués.
- Lancez un cycle de test pour vérifier le bon fonctionnement.

### Assembling the Guide Cover/Instalación de las cubiertas con guía/Installation du cache-guide

**Clamp-type / Con abrazadera / À brides**

Attach a guide cover to each corner of the pedestal. Each guide cover is labeled (RF for front right, LF for front left, RR for rear right, and LR for rear left) so you can identify the correct corner to attach it to.

Coloque una cubierta con guía en cada esquina del pedestal. Cada cubierta con guía está rotulada (RF para frontal derecha, LF o LF para frontal izquierda, RR para posterior derecha y LR para posterior izquierda) de forma que pueda identificar en qué esquina debe colocarla.

Installez un cache-guide à chaque coin du socle. Chaque cache-guide porte une étiquette (RF pour l'avant droit, LF ou LF pour l'avant gauche, RR pour l'arrière droit et LR pour l'arrière gauche), afin que vous puissiez identifier le coin sur lequel vous devez l'installer.

**Bracket-type / Con ménsula / À support**

- Unscrew. Quite el tornillo. Retirez la vis.
- Attach the guide cover. Coloque la cubierta con guía. Installez le cache-guide.
- Screw in the M4 screw. Ajuste el tornillo M4. Vissez la vis M4.

## Pedestal Installation Instructions / Instrucciones de instalación del pedestal / Instructions pour l'installation du socle

### Components / Componentes / Composants

X12	SCREW TAPPING TORNILLO DE ROSCA VIS TARAUDEUSE	X4	DOUBLE FACE TAPE CINTA BIFAZ ADHÉSIF DOUBLE FACE
X4	BRACKET LEG SOPORTE PARA PATAS SUPPORT DE PIED		GUIDE COVER RIGHT / GUIDE COVER LEFT CUBIERTA CON GUÍA DERECHA / CUBIERTA CON GUÍA IZQUIERDA CACHE-GUIDE DROIT / CACHE-GUIDE GAUCHE

### Tools / Herramientas / Outils

Wrench / Llave inglesa / Clé anglaise	Phillips Screwdriver / Destornillador / Phillips / Tournevis cruciforme	Flat Screwdriver / Destornillador plano / Tournevis plat
---------------------------------------	---	--

Supplied with Washing Machine or General Wrench (9/16 inch or 14 mm)  
La suministrada con la lavadora o una llave inglesa general (9/16 pulgadas o 14 mm)  
Livrée avec le lave-linge ou la clé générale (9/16 pouces ou 14 mm)

- Clean the floor where you intend to install the pedestal, then move the pedestal near where you intend to install it. Make sure to leave yourself space at all four corners so you can access the legs underneath.
- Level the pedestal with a wrench, adjusting all four legs as necessary. Use a level to make sure that the pedestal is level side to side and back to front. Do not tighten the locknuts above the feet at this time.
- Turn the feet of the washer or dryer so that the feet are as close to the body of the washer or dryer as possible, then lock them in place. Place the washer or dryer onto the pedestal so that the feet rest properly in the clamps. See 3-a for the correct placement of the dryer and 3-b for the washer.

**Caution / Atención / Attention**  
To prevent a fall, use caution when mounting the washer or dryer on top of the pedestal.  
Para evitar una caída, tenga cuidado al instalar la lavadora o la secadora en el pedestal.  
Pour éviter toute chute, soyez attentifs lors du montage du lave-linge ou du sèche-linge sur le dessus du socle.

**3-a**  
Place the feet of the dryer in the inner circle of the safe landing grooves on the pedestal. The location of the safe landing groove for the dryer is highlighted above.

**3-b**  
Place the feet of the washer in the outer circle of the safe landing grooves on the pedestal. The location of the safe landing groove for the washer is highlighted above.

**4**  
Attach a bracket leg to each foot of the washer or dryer on the pedestal, and then secure it with 4x12 screws (A).

**Important:** All feet must be fixed. Inserte un soporte para patas en cada pie de la lavadora o secadora sobre el pedestal, y luego ajústelo usando tornillos 4x12 (A).

**Important:** Todos los pies deben estar fijados. Instale un soporte de pies sur chaque pied du lave-linge ou sèche-linge placé sur le socle, puis fixez-le en place à l'aide de 4 x 12 vis (A).

**Important:** tous les pieds doivent être fixés.

Code No. : DC68-02931D-01

- Remove the Shipping bolts from the washing machine. Retirez les vis de transport de la lavadora.
- Move the assembled units to their final installation site. Transporte las unidades ensambladas a su lugar de instalación definitivo.
- Using a level, make sure the units are level side to side and front to back. Do additional leveling as needed. Proper leveling keeps vibration at a minimum.
- After the washer is fully installed, run a spin test. To run a spin test, put a small load into the washer, wet the clothes, and then select Spin Only mode. If there is too much vibration, repeat Step 7.
- Once the washer is stabilized and does not vibrate, tighten the lock nuts on each leg of the pedestal using a flat head screwdriver.
- When you install the pedestal on smooth floors such as tiles, peel out the double-face tape. Attach it under the all legs.

**Tips for installation on Wooden Panel Floors / Sugerencias para la instalación en suelos de paneles de madera / Conseils pour l'installation sur un parquet**

Put the legs on the same floor panels and keep them away from the floor lines. Ponga las patas sobre los mismos paneles del suelo y apartélas de las líneas del suelo. Placez les pieds sur les mêmes lames et éloignez-les des joints du plancher.

### Warranty

**SAMSUNG LAUNDRY PEDESTAL LIMITED WARRANTY TO ORIGINAL PURCHASER**  
**This SAMSUNG brand product, as supplied and distributed by SAMSUNG ELECTRONICS AMERICA, INC. (SAMSUNG) and delivered new, in the original carton to the original consumer purchaser, is warranted by SAMSUNG against manufacturing defects in materials and workmanship for a limited warranty period of:**

**One (1) Year All Parts and Labor**

This limited warranty begins on the original date of purchase, and is valid only on products purchased and used in the United States. To receive warranty service, the purchaser must contact SAMSUNG for problem determination and service procedures. Warranty service can only be performed by a SAMSUNG authorized service center. The original dated bill of sale must be presented upon request as proof of purchase to SAMSUNG or SAMSUNG's authorized service center. SAMSUNG will provide in-home service during the warranty period at no charge, subject to availability within the contiguous United States.

In-home service is not available in all areas.

To receive in-home service, product must be unobstructed and accessible to the service agent. If service is not available, SAMSUNG may elect to provide transportation of the product to and from an authorized service center.

SAMSUNG will repair, replace, or refund this product at our option and at no charge as stipulated herein, with new or reconditioned parts or products if found to be defective during the limited warranty period specified above. All replaced parts and products become the property of SAMSUNG and must be returned to SAMSUNG. Replacement parts and products assume the remaining original warranty, or ninety (90) days, whichever is longer. This limited warranty covers manufacturing defects in materials and workmanship encountered in normal, noncommercial use of this product and shall not apply to the following: damage that occurs in shipment; delivery and installation; applications and uses for which this product was not intended; altered product or serial numbers; cosmetic damage or exterior finish; accidents, abuse, neglect, fire, water, lightning, or other acts of nature or God; use of products, equipment, systems, utilities, services, parts, supplies, accessories, applications, installations, repairs, external wiring or connectors not supplied or authorized by SAMSUNG that damage this product or result in service problems; incorrect electrical line voltage, fluctuations and surges; customer adjustments and failure to follow operating instructions, maintenance and environmental instructions that are covered and prescribed in the instruction book; product removal and reinstallation; problems caused by pest infestations. This limited warranty does not cover problems resulting from electric current, voltage or supply, light bulbs, house fuses, house wiring, cost of a service call for instructions, or fixing installation errors. SAMSUNG does not warrant uninterrupted or error-free operation of the product.

**EXCEPT AS SET FORTH HEREIN, THERE ARE NO WARRANTIES ON THIS PRODUCT EITHER EXPRESS OR IMPLIED, AND SAMSUNG DISCLAIMS ALL WARRANTIES INCLUDING, BUT NOT LIMITED TO, ANY IMPLIED WARRANTIES OF MERCHANTABILITY, INFRINGEMENT OR FITNESS FOR A PARTICULAR PURPOSE. NO WARRANTY OR GUARANTEE GIVEN BY ANY PERSON, FIRM, OR CORPORATION WITH RESPECT TO THIS PRODUCT SHALL BE BINDING ON SAMSUNG. SAMSUNG SHALL NOT BE LIABLE FOR LOSS OF REVENUE OR PROFITS, FAILURE TO REALIZE SAVINGS OR OTHER BENEFITS, OR ANY OTHER SPECIAL, INCIDENTAL OR CONSEQUENTIAL DAMAGES CAUSED BY THE USE, MISUSE, OR INABILITY TO USE THIS PRODUCT. REGARDLESS OF THE LEGAL THEORY ON WHICH THE CLAIM IS BASED, AND EVEN IF SAMSUNG HAS BEEN ADVISED OF THE POSSIBILITY OF SUCH DAMAGES, NOT SHALL RECOVERY OF ANY KIND AGAINST SAMSUNG BE GREATER IN AMOUNT THAN THE PURCHASE PRICE OF THE PRODUCT SOLD BY SAMSUNG AND CAUSING THE ALLEGED DAMAGE, WITHOUT LIMITING THE FOREGOING, PURCHASER ASSUMES ALL RISK AND LIABILITY FOR LOSS, DAMAGE, OR INJURY TO PURCHASER AND PURCHASER'S PROPERTY AND TO OTHERS AND THEIR PROPERTY ARISING OUT OF THE USE, MISUSE, OR INABILITY TO USE THIS PRODUCT. THIS LIMITED WARRANTY SHALL NOT EXTEND TO ANYONE OTHER THAN THE ORIGINAL PURCHASER OF THIS PRODUCT, IS NONTRANSFERABLE AND STATES YOUR EXCLUSIVE REMEDY. Some states do not allow limitations on how long an implied warranty lasts, or the exclusion or limitation of incidental or consequential damages, so the above limitations or exclusions may not apply to you. This warranty gives you specific rights, and you may also have other rights, which vary from state to state.**

**To obtain warranty service, please contact SAMSUNG at: 1-800-SAMSUNG (1-800-726-7864) www.samsung.com**

# Product Overview

## Product Title

Samsung 27" Wide Front Load Pedestal

## Product Description (213 characters)

This 27" wide pedestal will allow you to lift your Samsung Front Load washer or dryer by more than a foot for a more convenient height. Tidy up your laundry space with an easily accessible built-in storage drawer.

- Compatible with Samsung 27" wide Front Load washers and dryers.
- Elevates your washer and dryer by more than a foot, for easier loading and unloading – no more bending.
- Provides an easily accessible storage drawer for your laundry cleaning supplies.



## Available Colors

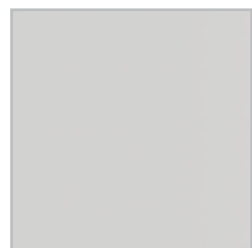

### Ivory

**Model Number:** WE402NE

**UPC:** 887276529073

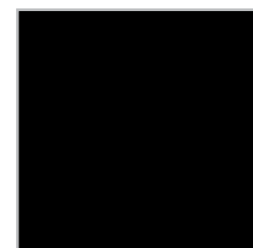

**Brushed Black / Black  
Stainless Steel**

**Model Number:** WE402NV

**UPC:** 887276310145



### Platinum

**Model Number:** WE402NP

**UPC:** 887276310138



### Champagne

**Model Number:** WE402NC

**UPC:** 887276310121



### White

**Model Number:** WE402NW

**UPC:** 887276310152



# Carousel Image Order

Easy Ads links

Retail.com: [https://dam.gettyimages.com/p/z0c3461/digital-appliances?o=AND&q=WE402\\*\\*%20carousel%20images%20rcom](https://dam.gettyimages.com/p/z0c3461/digital-appliances?o=AND&q=WE402**%20carousel%20images%20rcom)  
Samsung.com: [https://dam.gettyimages.com/p/z0c3461/digital-appliances?o=AND&q=WE402\\*\\*%20carousel%20images%20scom](https://dam.gettyimages.com/p/z0c3461/digital-appliances?o=AND&q=WE402**%20carousel%20images%20scom)



# Carousel Image Order

Easy Ads links

Retail.com: <https://dam.gettyimages.com/p/z0c3461/digital-appliances?o=AND&q=WE402NW%20carousel%20images%20rcom>  
 Samsung.com: <https://dam.gettyimages.com/p/z0c3461/digital-appliances?o=AND&q=WE402NW%20carousel%20images%20scom>



Image provided in decimals and fractions.





# Lifestyle Image

## Easy Ads link

<https://dam.gettyimages.com/p/z0c3461/digital-appliances?o=AND&q=WE402NW%20Lifestyle%20Images>

## Lifestyle Image





# Spec Sheet

## Easy Ads link

<https://dam.gettyimages.com/p/z0c3461/digital-appliances?o=AND&q=WE402NE%20spec%20sheet>

## WE402NV

Samsung Front Load Pedestal

## SAMSUNG



**Signature Features:**

- Compatible with Samsung 27" wide Front Load washers and dryers.
- Elevates your washer and dryer by more than a foot, for easier loading and unloading – no more bending.
- Provides an easily accessible storage drawer for your laundry cleaning supplies.

**Available Colors**

- Brushed Black/Black Stainless Steel (shown)
- Platinum
- Champagne
- Ivory
- White



---

<b>Product Dimensions &amp; Weight (WxHxD)</b>	<b>Color</b>	<b>Model #</b>	<b>UPC Code</b>
Dimensions: 27" x 14 <sup>1</sup> / <sub>2</sub> " x 28 <sup>1</sup> / <sub>8</sub> "	Brushed Black/Black Stainless Steel	WE402NV	887276310145
Weight: 36.6 lbs	Platinum	WE402NP	887276310138
<b>Shipping Dimensions &amp; Weight (WxHxD)</b>	Champagne	WE402NC	887276310121
Dimensions: 29 <sup>1</sup> / <sub>2</sub> " x 15 <sup>1</sup> / <sub>2</sub> " x 33"	Ivory	WE402NE	887276529073
Weight: 41 lbs	White	WE402NW	887276310152
<b>Warranty</b>			
One (1) Year Parts and Labor			

Actual color may vary. Design, specifications, and color availability are subject to change without notice. Non-metric weights and measurements are approximate.  
©2021 Samsung Electronics America, Inc. 85 Challenger Road, Ridgefield Park, NJ 07660. Tel: 800-SAMSUNG. samsung.com. Samsung is a registered trademark of Samsung Electronics Co., Ltd.

Pedestal Spec Sheet

# Installation Guide

## Easy Ads link

<https://dam.gettyimages.com/p/z0c3461/digital-appliances?o=AND&q=WE402NE%20installation%20guide>

### Pedestal Installation Instructions / Instrucciones de instalación del pedestal / Instructions pour l'installation du socle

#### Components / Componentes / Composants



#### Tools / Herramientas / Outils

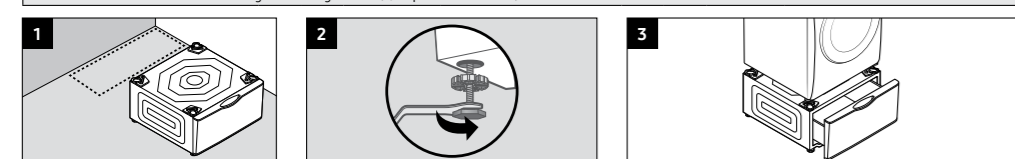
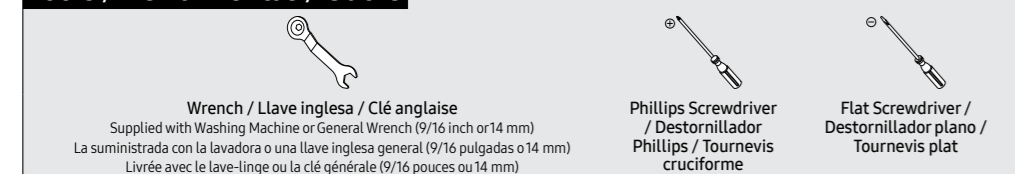

**1** Clean the floor where you intend to install the pedestal, then move the pedestal near where you intend to install it. Make sure to leave yourself space at all four corners so you can access the legs underneath.  
Limpie bien el suelo donde vaya a instalar el pedestal y a continuación déjelo este cerca de su lugar de instalación. Deje suficiente espacio en cada una de las cuatro esquinas para que pueda acceder fácilmente a las patas de la parte inferior. Nettoyez le sol où vous prévoyez d'installer le socle, puis déplacez le socle à proximité de cet emplacement. Assurez-vous de laisser un espace suffisant aux quatre coins pour pouvoir accéder aux pieds.

**2** Level the pedestal with a wrench, adjusting all four legs as necessary. Use a level to make sure that the pedestal is level side to side and back to front. Do not tighten the locknuts above the feet at this time.  
Nivele el pedestal con una llave inglesa ajustando las cuatro patas según sea necesario. Use un nivel para que el pedestal esté nivelado de lado a lado y de adelante atrás. No apriete aún la contratuercas que está encima de las patas. Mettez le socle de niveau avec une clé anglaise en ajustant les quatre pieds. Utilisez un niveau pour vous assurer que le socle est de niveau aussi bien entre les côtés droit et gauche qu'entre l'avant et l'arrière. À ce stade, ne serrez pas les contre-écrous situés au-dessus des pieds.

**3** Turn the feet of the washer or dryer so that the feet are as close to the body of the washer or dryer as possible, then lock them in place. Place the washer or dryer onto the pedestal so that the feet rest properly in the clamps. See 3-a for the correct placement of the dryer and 3-b for the washer.  
Gire las patas de la lavadora o la secadora de modo que queden lo más cerca posible de la lavadora o la secadora y, a continuación, asegúnelas en su lugar. Coloque la lavadora o la secadora sobre el pedestal de modo que las patas descansen adecuadamente en las abrazaderas. Vea 3-a para la correcta instalación de la secadora y 3-b para la lavadora. Tournez les pieds du lave-linge ou du sèche-linge afin que ceux-ci soient aussi près que possible du corps du lave-linge ou du sèche-linge, puis verrouillez-les. Placez le lave-linge ou le sèche-linge sur le socle de manière que les pieds reposent correctement dans les colliers. Reportez-vous à 3-a pour le placement correct du sèche-linge et 3-b pour le lave-linge.

**Caution / Atención / Attention**  
To prevent a fall, use caution when mounting the washer or dryer on top of the pedestal.  
Para evitar una caída, tenga cuidado al instalar la lavadora o la secadora en el pedestal.  
Pour éviter toute chute, soyez attentifs lors du montage du lave-linge ou du sèche-linge sur le dessus du socle.

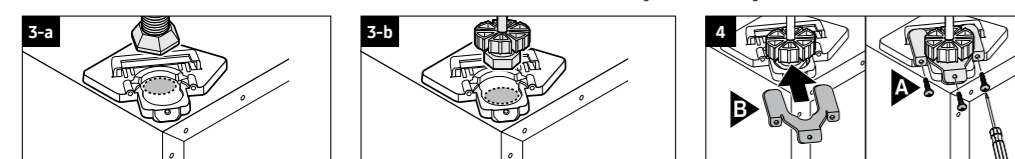

**3-a** Place the feet of the dryer in the inner circle of the safe landing grooves on the pedestal. The location of the safe landing groove for the dryer is highlighted above.  
Coloque las patas de la secadora en el círculo interior de las ranuras de posición segura del pedestal. La ubicación de las ranuras de posición segura de la secadora se destaca en la ilustración superior.  
Placez les pieds du sèche-linge dans le cercle intérieur des rainures du socle. L'emplacement de la rainure pour le sèche-linge est signalé ci-dessus.

**3-b** Place the feet of the washer in the outer circle of the safe landing grooves on the pedestal. The location of the safe landing groove for the washer is highlighted above.  
Coloque las patas de la lavadora en el círculo exterior de las ranuras de posición segura del pedestal. La ubicación de las ranuras de posición segura de la lavadora se destaca en la ilustración superior.  
Placez les pieds du lave-linge dans le cercle extérieur des rainures du socle. L'emplacement de la rainure pour le lave-linge est signalé ci-dessus.

Code No. : DC68-02931D-01

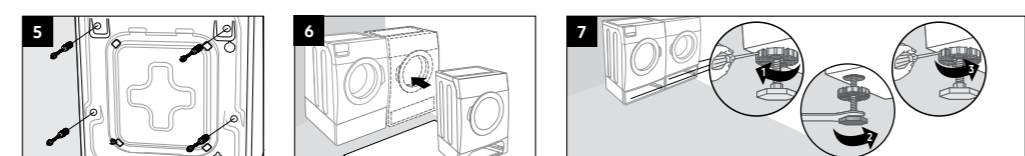

**5** Remove the Shipping bolts from the washing machine.  
Retire los tornillos de transporte de la lavadora.  
Retirez les vis de transport du lave-linge.

**6** Move the assembled units to their final installation site.  
Transporte las unidades ensambladas a su lugar de instalación definitivo.  
Déplacez les appareils assemblés à leur emplacement d'installation finale.

**7** Using a level, make sure the units are level side to side and front to back. Do additional leveling as needed. Proper leveling keeps vibration at a minimum. Con un nivel, compruebe si las unidades están niveladas de lado a lado y de adelante atrás. Realice la nivelación adicional necesaria. Una nivelación correcta reduce la vibración al mínimo. Assurez-vous que les appareils sont de niveau de droite à gauche et de l'avant à l'arrière à l'aide d'un niveau. Réglez à nouveau le niveau si nécessaire. Une bonne mise de niveau permet de maintenir les vibrations au minimum.

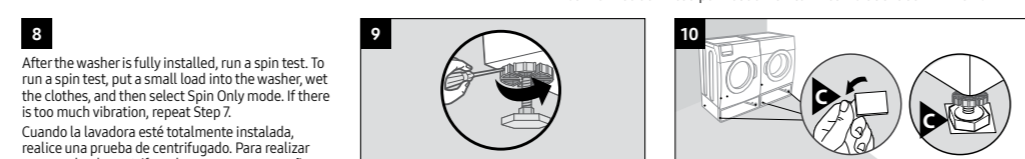

**8** After the washer is fully installed, run a spin test. To run a spin test, put a small load into the washer, wet the clothes, and then select Spin Only mode. If there is too much vibration, repeat Step 7.  
Cuando la lavadora esté totalmente instalada, realice una prueba de centrifugado. Para realizar una prueba de centrifugado, ponga una pequeña carga de ropa en la lavadora, mójela y seleccione el modo Spin Only (Sólo centrifugado). Si hay demasiadas vibraciones, repita el paso 7. Une fois l'installation du lave-linge terminée, lancez un test d'essorage. Pour effectuer un test d'essorage, déposez une faible charge dans le lave-linge, mouillez les vêtements et sélectionnez le mode Essorage seulement. Si les vibrations sont trop importantes, répétez l'étape 7.

**9** Once the washer is stabilized and does not vibrate, tighten the lock nuts on each leg of the pedestal using a flat head screwdriver.  
Cuando la lavadora esté estabilizada y no vibre, apriete las tuercas de seguridad de cada pata del pedestal mediante un destornillador plano. Une fois que le lave-linge est stabilisé et ne vibre pas, serrez les contre-écrous sur chaque pied du socle à l'aide d'un tournevis plat.

**10** When you install the pedestal on smooth floors such as tiles:  
• Peel out the double-face tape.  
• Attach it under the all legs.  
Al instalar el pedestal en superficies lisas revisadas:  
• Pele una cinta bifaz.  
• Péguela bajo todas las patas.  
Lorsque vous posez le socle sur des sols mous tels que des moquettes:  
• Décollez le adhésif double face.  
• Collez-la sous tous les pieds.

#### Tips for Installation on Wooden Panel Floors / Sugerencias para la instalación en suelos de paneles de madera / Conseils pour l'installation sur un parquet

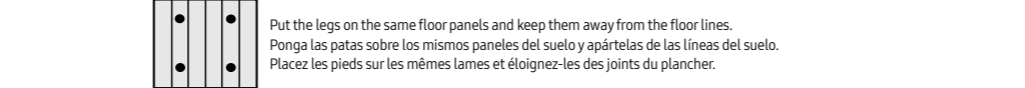

Put the legs on the same floor panels and keep them away from the floor lines.  
Ponga las patas sobre los mismos paneles del suelo y apartelas de las líneas del suelo.  
Placez les pieds sur les mêmes lames et éloignez-les des joints du plancher.

#### Warranty

**SAMSUNG LAUNDRY PEDESTAL LIMITED WARRANTY TO ORIGINAL PURCHASER**  
**This SAMSUNG brand product, as supplied and distributed by SAMSUNG ELECTRONICS AMERICA, INC. (SAMSUNG) and delivered new, in the original carton to the original consumer purchaser, is warranted by SAMSUNG against manufacturing defects in materials and workmanship for a limited warranty period of:**  
**One (1) Year All Parts and Labor**  
This limited warranty begins on the original date of purchase, and is valid only on products purchased and used in the United States. To receive warranty service, the purchaser must contact SAMSUNG for problem determination and service procedures. Warranty service can only be performed by a SAMSUNG authorized service center. The original dated bill of sale must be presented upon request as proof of purchase to SAMSUNG or SAMSUNG's authorized service center. SAMSUNG will provide in-home service during the warranty period at no charge, subject to availability within the contiguous United States.  
In-home service is not available in all areas.  
To receive in-home service, product must be unobstructed and accessible to the service agent. If service is not available, SAMSUNG may elect to provide transportation of the product to and from an authorized service center.  
SAMSUNG will repair, replace, or refund this product at our option and at no charge as stipulated herein, with new or reconditioned parts or products if found to be defective during the limited warranty period specified above. All replaced parts and products become the property of SAMSUNG and must be returned to SAMSUNG. Replacement parts and products assume the remaining original warranty, or ninety (90) days, whichever is longer. This limited warranty covers manufacturing defects in materials and workmanship encountered in normal, noncommercial use of this product and shall not apply to the following: damage that occurs in shipment; delivery and installation; applications and uses for which this product was not intended; altered product or serial numbers; cosmetic damage or exterior finish; accidents, abuse, neglect, fire, water, lightning, or other acts of nature or God; use of products, equipment, systems, utilities, services, parts, supplies, accessories, applications, installations, repairs, external wiring or connectors not supplied or authorized by SAMSUNG that damage this product or result in service problems; incorrect electrical line voltage, fluctuations and surges; customer adjustments and failure to follow operating instructions, maintenance and environmental instructions that are covered and prescribed in the instruction book; product removal and reinstallation; problems caused by pest infestations. This limited warranty does not cover problems resulting from electric current, voltage or supply, light bulbs, house fuses, house wiring, cost of a service call for instructions, or fixing installation errors. SAMSUNG does not warrant uninterrupted or error-free operation of the product.  
EXCEPT AS SET FORTH HEREIN, THERE ARE NO WARRANTIES ON THIS PRODUCT EITHER EXPRESS OR IMPLIED, AND SAMSUNG DISCLAIMS ALL WARRANTIES INCLUDING, BUT NOT LIMITED TO, ANY IMPLIED WARRANTIES OF MERCHANTABILITY, FITNESS FOR A PARTICULAR PURPOSE, NO WARRANTY OR GUARANTEE GIVEN BY ANY PERSON, FIRM, OR CORPORATION WITH RESPECT TO THIS PRODUCT SHALL BE BINDING ON SAMSUNG. SAMSUNG SHALL NOT BE LIABLE FOR LOSS OF REVENUE OR PROFITS, FAILURE TO REALIZE SAVINGS OR OTHER BENEFITS, OR ANY OTHER SPECIAL, INCIDENTAL OR CONSEQUENTIAL DAMAGES CAUSED BY THE USE, MISUSE, OR INABILITY TO USE THIS PRODUCT, REGARDLESS OF THE LEGAL THEORY ON WHICH THE CLAIM IS BASED, AND EVEN IF SAMSUNG HAS BEEN ADVISED OF THE POSSIBILITY OF SUCH DAMAGES. NOR SHALL RECOVERY OF ANY KIND AGAINST SAMSUNG BE GREATER IN AMOUNT THAN THE PURCHASE PRICE OF THE PRODUCT SOLD BY SAMSUNG AND CAUSING THE ALLEGED DAMAGE. WITHOUT LIMITING THE FOREGOING, PURCHASER ASSUMES ALL RISK AND LIABILITY FOR LOSS, DAMAGE, OR INJURY TO PURCHASER AND PURCHASER'S PROPERTY AND TO OTHERS AND THEIR PROPERTY ARISING OUT OF THE USE, MISUSE, OR INABILITY TO USE THIS PRODUCT. THIS LIMITED WARRANTY SHALL NOT EXTEND TO ANYONE OTHER THAN THE ORIGINAL PURCHASER OF THIS PRODUCT, IS NONTRANSFERABLE AND STATES YOUR EXCLUSIVE REMEDY. Some states do not allow limitations on how long an implied warranty lasts, or the exclusion or limitation of incidental or consequential damages, so the above limitations or exclusions may not apply to you. This warranty gives you specific rights, and you may also have other rights, which vary from state to state.  
**To obtain warranty service, please contact SAMSUNG at:**  
**1-800-SAMSUNG (1-800-726-7864)**  
**www.samsung.com**

# Product Overview

## Product Title

Samsung 27" Wide Front Load Riser

## Product Description (118 characters)

This 27" wide riser will allow you to lift your Samsung Front Load washer or dryer by 6" to a more convenient height.

- Compatible with Samsung 27" wide Front Load washers and dryers.
- Perfect addition to your FlexWash™ washer or FlexDry™ dryer, providing easy access for loading and unloading.
- Meet ADA standards by simply pairing this riser with any Samsung 27" wide Front Load washer or dryer.



## Available Colors

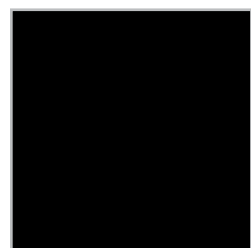

**Brushed Black / Black  
Stainless Steel**  
**Model Number:** WE272NV  
**UPC:** 887276197630



**Champagne**  
**Model Number:** WE272NC  
**UPC:** 887276393940



**White**  
**Model Number:** WE272NW  
**UPC:** 887276197647



# Carousel Image Order

Easy Ads links

Retail.com: <https://dam.gettyimages.com/p/z0c3461/digital-appliances?o=AND&q=WE272NW%20carousel%20images%20rcom>  
Samsung.com: <https://dam.gettyimages.com/p/z0c3461/digital-appliances?o=AND&q=WE272NW%20carousel%20images%20scom>

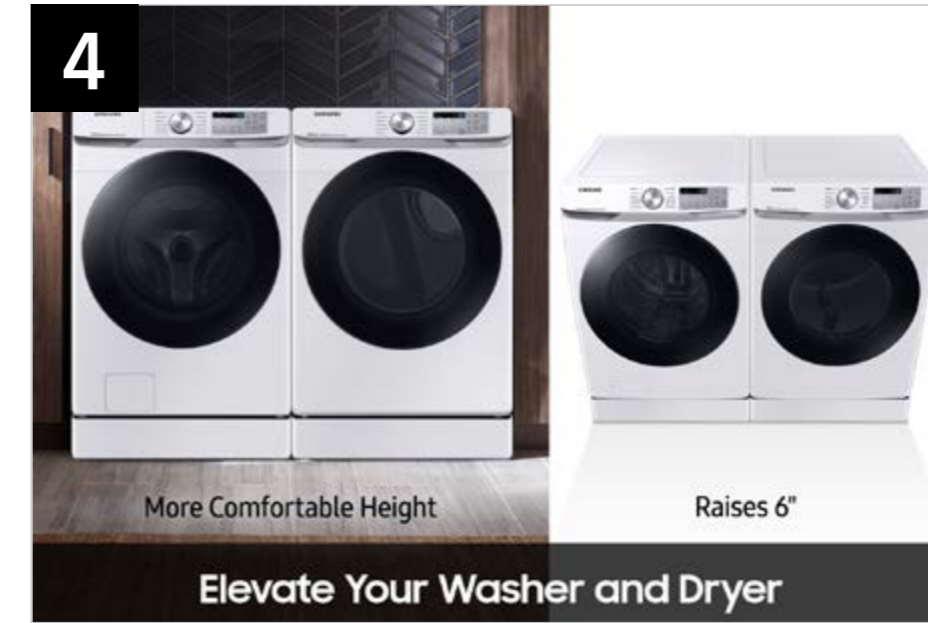

Image provided in decimals and fractions.

# Lifestyle Image

## Easy Ads link

<https://dam.gettyimages.com/p/z0c3461/digital-appliances?o=AND&q=WE272NW%20Lifestyle%20Images>

## Lifestyle Image



# Spec Sheet

## Easy Ads link

<https://dam.gettyimages.com/p/z0c3461/digital-appliances?o=AND&q=WE272NV%20Spec%20Sheet>

### WE272NV

Samsung Front Load Riser

### SAMSUNG

**Signature Features:**

- This 27" wide riser will allow you to lift your Samsung Front Load washer or dryer by 6" to a more convenient height.
- Perfect addition to your FlexWash™ washer or FlexDry™ dryer, providing easy access for loading and unloading.
- Meet ADA standards by simply pairing this riser with any Samsung 27" wide Front Load washer or dryer.

**Available Colors**

Brushed Black/Black Stainless Steel (shown)

Champagne

White

---

<b>Product Dimensions &amp; Weight (WxHxD)</b> Dimensions: 27" x 6 1/8" x 29 3/8" Weight: 16.8 lbs	<b>Color</b>	<b>Model #</b>	<b>UPC Code</b>
	Brushed Black/Black Stainless Steel	WE272NV	887276197630
	Champagne	WE272NC	887276393940
	White	WE272NW	887276197647
<b>Shipping Dimensions &amp; Weight (WxHxD)</b> Dimensions: 30" x 8 3/16" x 33 3/16" Weight: 23.6 lbs	<b>Warranty</b> One (1) Year Parts and Labor		

Actual color may vary. Design, specifications, and color availability are subject to change without notice. Non-metric weights and measurements are approximate.  
©2017 Samsung Electronics America, Inc. 85 Challenger Road, Ridgefield Park, NJ 07660. Tel: 800-SAMSUNG, samsung.com. Samsung is a registered trademark of Samsung Electronics Co., Ltd.

## Riser Spec Sheet



**SAMSUNG**