

VIEW A-A

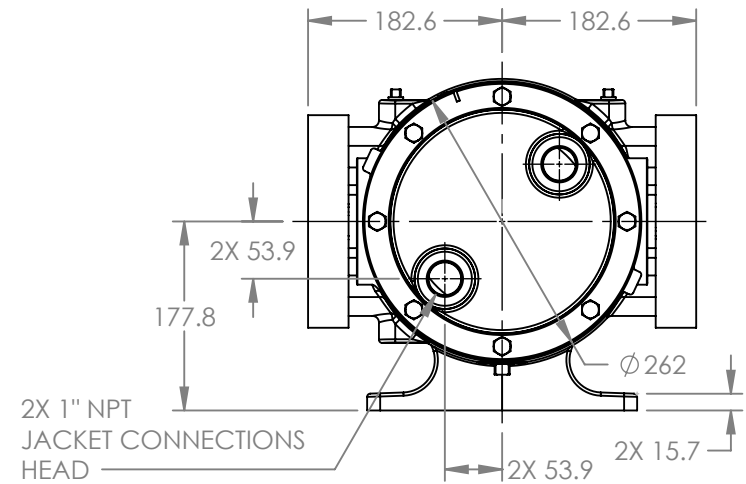
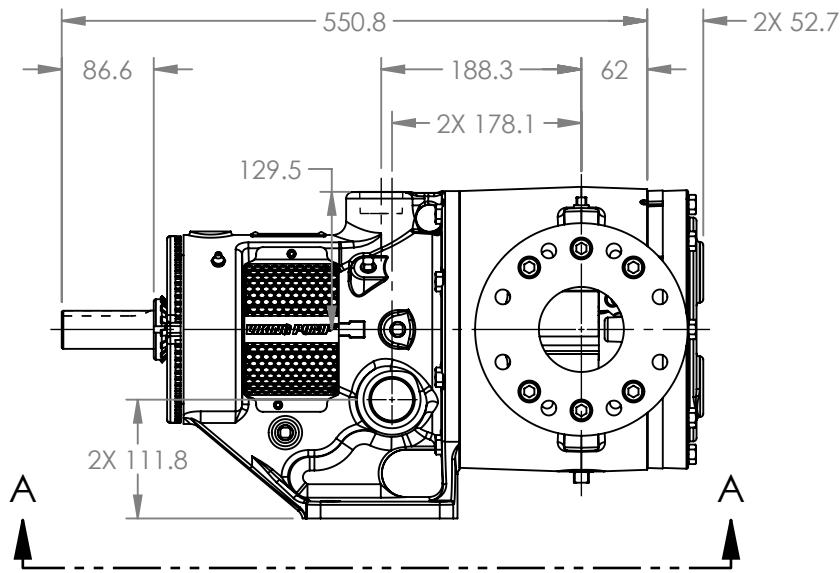

MODELS WITH OPTIONAL FLANGED PORTS:
LS224C, LS1224C, LS4224C

NOTES:
1. ALL DIMENSIONS ARE FOR REFERENCE ONLY.

STATE	Released	02/06/2026
DRAWN	DLende	Jan 28 2026 00:00 A
CHECKED	AE	02/06/2026

DIMENSIONS ARE IN
MILLIMETERS

PROJECT E399

WAS:



VIKING PUMP, INC.
A Unit of IDEX Corporation
Cedar Falls, IA, 50613 U.S.A.
VIKINGPUMP.COM

THIS DRAWING IS THE PROPERTY OF
VIKING PUMP, INC. AND IS PROPRIETARY
IN GENERAL AND DETAIL. IT SHALL NOT BE
COPIED OR ITS CONTENTS REVEALED TO
OUTSIDE PARTIES WITHOUT THE WRITTEN
CONSENT OF VIKING PUMP, INC.

3D

DWG. NO.
LV-4893

SHEET 1 OF 1

REV. A.0

02/06/2026