

PORTS: 2X 3" FLANGES/NPT
DRILLED AND TAPPED
SUITABLE FOR USE WITH
CLASS 125 ANSI FLANGES

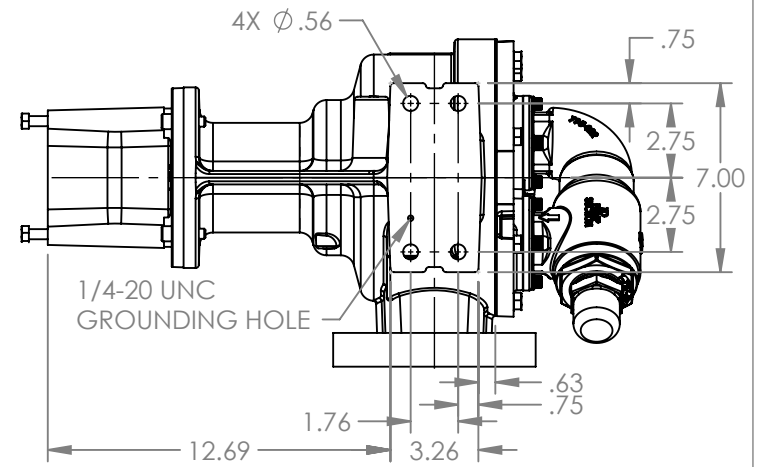

VIEW A-A

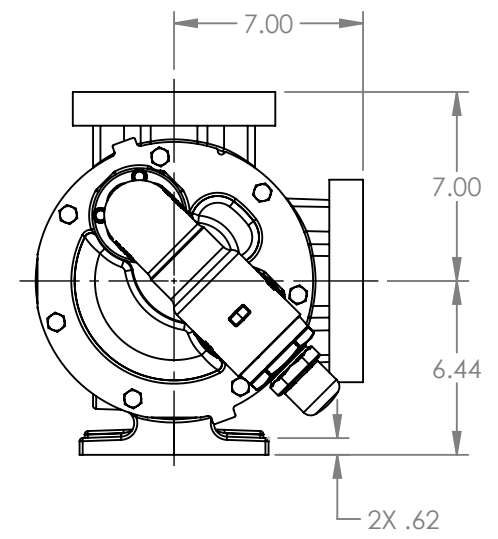
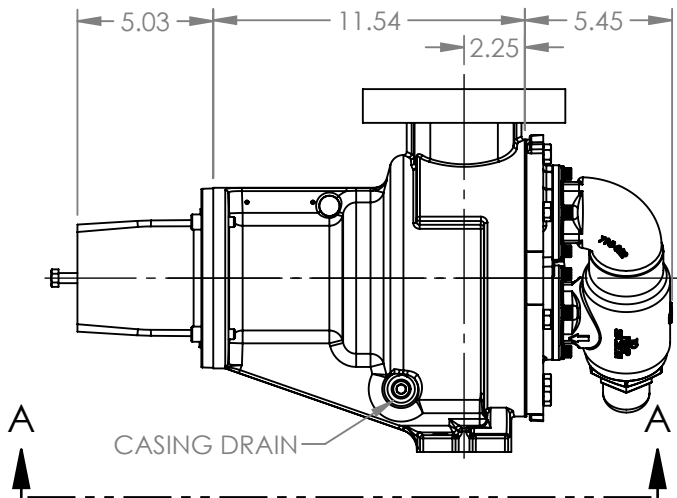
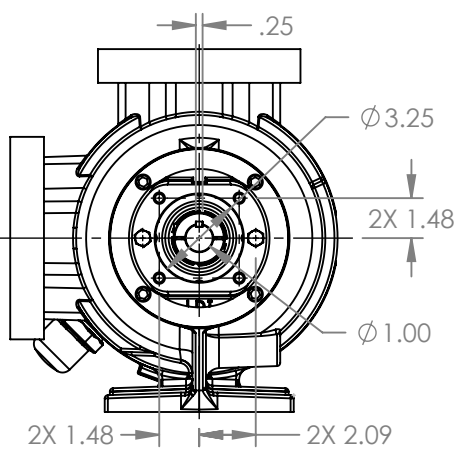

STANDARD MODELS: RTPg30M

STATE	Released	11/25/2025
DRAWN	aries	06/11/2025
CHECKED	JDP	11/25/2025

DIMENSIONS ARE IN INCHES
PROJECT E397
WAS:

VIKING PUMP
VIKING PUMP, INC.
A Unit of IDEX Corporation
Cedar Falls, IA, 50613 U.S.A.
VIKINGPUMP.COM

THIS DRAWING IS THE PROPERTY OF
VIKING PUMP, INC. AND IS PROPRIETARY
IN GENERAL AND DETAIL. IT SHALL NOT BE
COPIED OR ITS CONTENTS REVEALED TO
OUTSIDE PARTIES WITHOUT THE WRITTEN
CONSENT OF VIKING PUMP, INC.

3D

DWG. NO.
LV-4778

SHEET 1 OF 2

REV. A.1
5/14/2025

NOTES:
1. ALL DIMENSIONS ARE FOR REFERENCE ONLY.

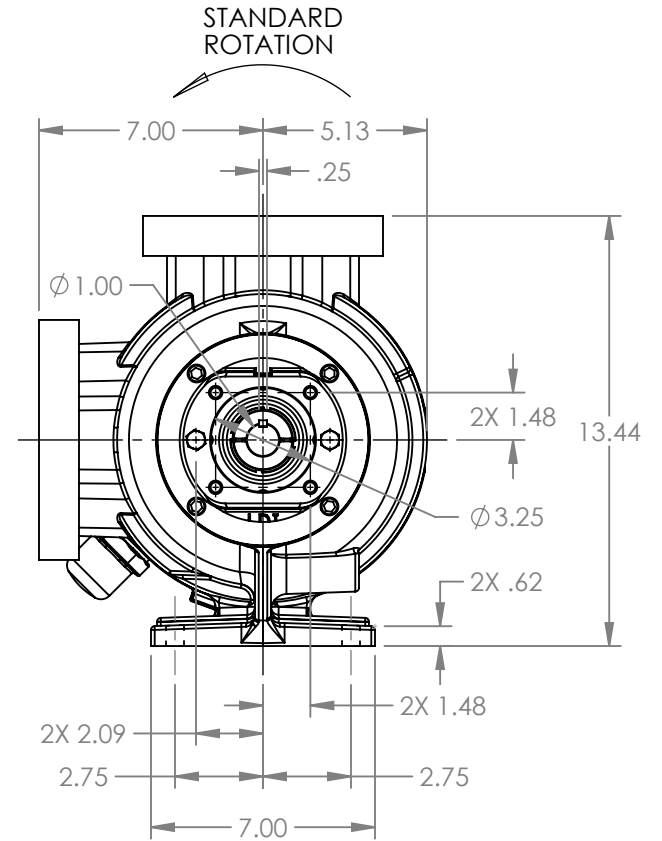
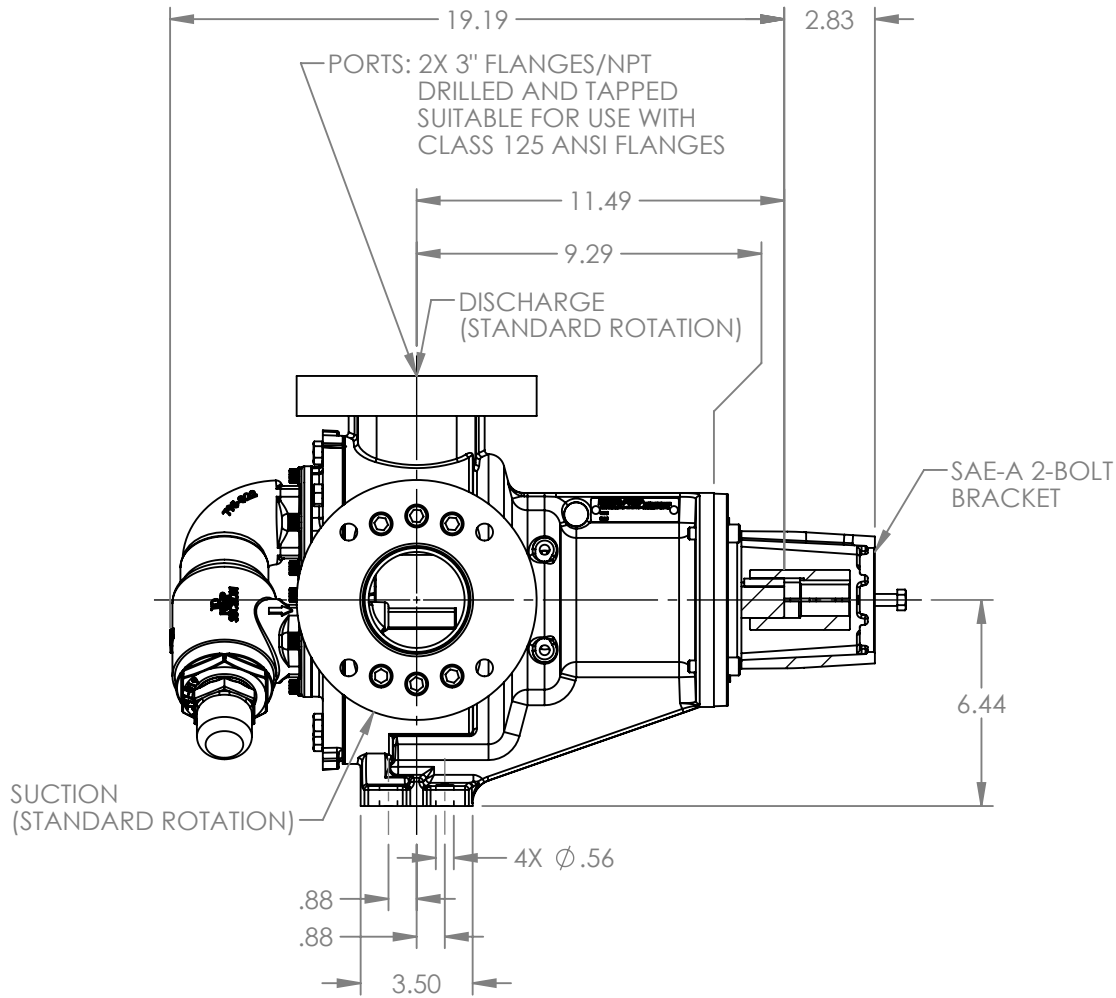

STATE	Released	11/25/2025
DRAWN	aries	06/11/2025
CHECKED	JDP	11/25/2025

DIMENSIONS ARE IN
INCHES

PROJECT: E397

WAS:



VIKING PUMP, INC.
A Unit of IDEX Corporation
Cedar Falls, IA 50613 U.S.A.
VIKINGPUMP.COM

THIS DRAWING IS THE PROPERTY OF
VIKING PUMP, INC. AND IS PROPRIETARY
IN GENERAL AND DETAIL. IT SHALL NOT BE
COPIED OR ITS CONTENTS REVEALED TO
OUTSIDE PARTIES WITHOUT THE WRITTEN
CONSENT OF VIKING PUMP, INC.

3D

DWG. NO.
LV-4778

SHEET 2 OF 2

REV. A.1

11/25/2025