

PORTS: 2X FLANGES
SUITABLE FOR USE WITH
DIN 65 PN 16 FLANGES

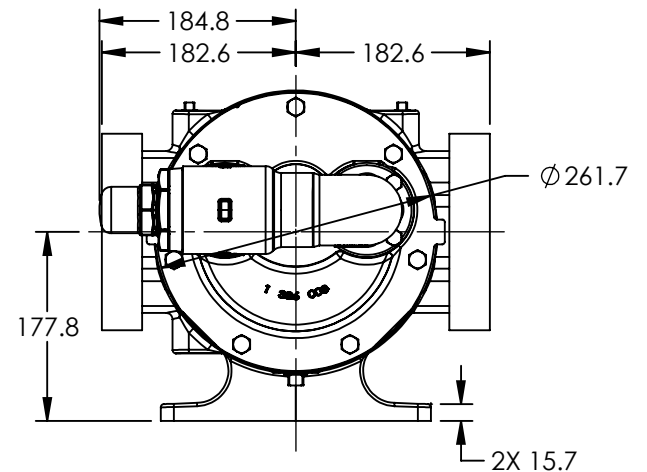
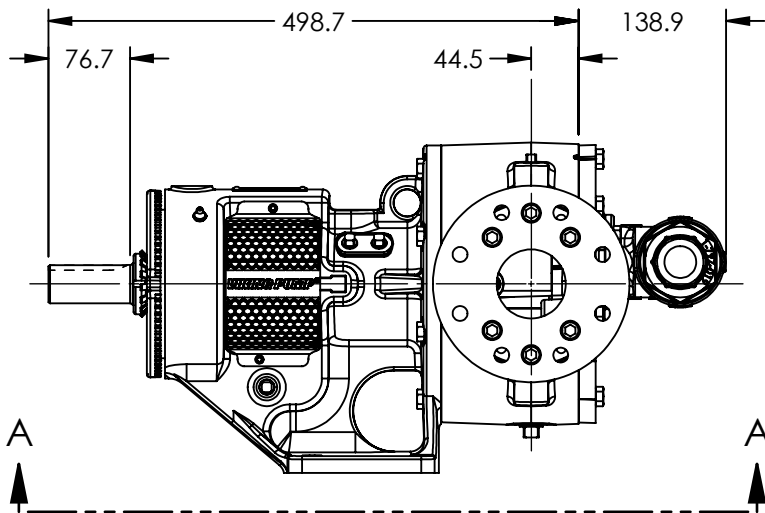
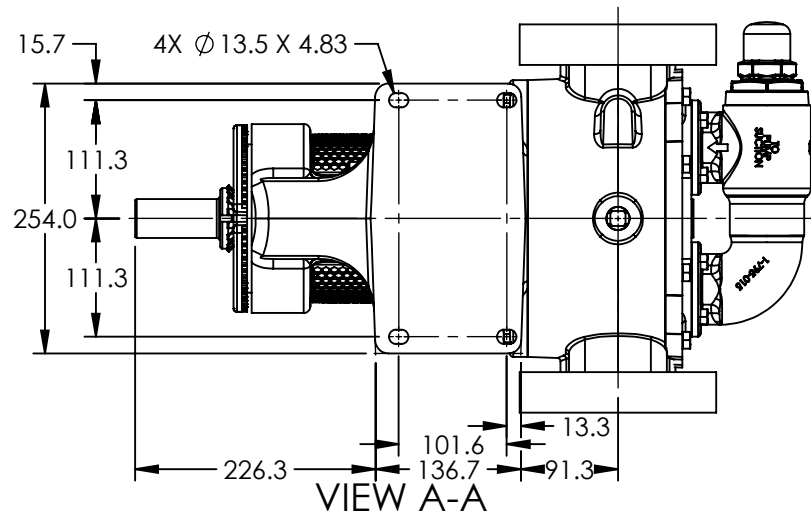

MODELS WITH OPTIONAL FLANGED PORTS:
L123C, L4123C, L127C, L1127C, L4127C

NOTES:
1. ALL DIMENSIONS ARE FOR REFERENCE ONLY.

STATE	Released	04/16/2024
DRAWN	dalcorn	07/25/2023
CHECKED	JB	04/16/2024

DIMENSIONS ARE IN
MILLIMETERS
PROJECT E330
WAS:



VIKING PUMP, INC.
A Unit of IDEX Corporation
Cedar Falls, IA, 50613 U.S.A.
VIKINGPUMP.COM

THIS DRAWING IS THE PROPERTY OF
VIKING PUMP, INC. AND IS PROPRIETARY
IN GENERAL AND DETAIL. IT SHALL NOT BE
COPIED OR ITS CONTENTS REVEALED TO
OUTSIDE PARTIES WITHOUT THE WRITTEN
CONSENT OF VIKING PUMP, INC.

3D

DWG. NO.
LV-4650

SHEET 1 OF 1

REV. A.1

04/16/2024