

- NOTES:
1. COUPLING GUARD NOT SHOWN IN TOP VIEW.
 2. ALL DIMENSIONS ARE FOR REFERENCE ONLY.

MODELS: GB-425073-R00-D, GB-425073-R10-D

STATE	Released	07/19/2023	DIMENSIONS ARE IN INCHES
DRAWN	bmanternach	2/9/2023	
CHECKED	BAM	07/19/2023	
PROJECT: E324			WAS:



VIKING PUMP, INC.
A Unit of IDEX Corporation
Cedar Falls, IA 50613
U.S.A.

THIS DRAWING IS THE PROPERTY OF VIKING PUMP, INC. AND IS PROPRIETARY IN GENERAL AND DETAIL. IT SHALL NOT BE COPIED OR ITS CONTENTS REVEALED TO OUTSIDE PARTIES WITHOUT THE WRITTEN CONSENT OF VIKING PUMP, INC.

3D

DWG. NO.
GPV-25073-6

SHEET 1 OF 1

REV. A.1

07/19/2023



No.:

Date: 08-MAR-2018

Customer :

TECHNICAL PROPOSAL

Three-phase induction motor - Squirrel cage rotor

Product line : W22 NEMA Premium - Ball Bearings

Catalog Number : 40012ET3G586/7-W22

List Price : \$ Contact us for new item

Notes:

Performed by:

Checked:



No.:

Date: 08-MAR-2018

DATA SHEET

Three-phase induction motor - Squirrel cage rotor

Customer :
Product line : W22 NEMA Premium - Ball Bearings

Frame : 586/7T
Output : 400 HP
Frequency : 60 Hz
Poles : 6
Full load speed : 1190 rpm
Slip : 0.83 %
Voltage : 460 V
Rated current : 483 A
Locked rotor current : 2900 A
Locked rotor current (I_L/I_n) : 6.0
No-load current : 200 A
Full load torque : 1741 lb.ft
Locked rotor torque : 220 %
Breakdown torque : 210 %
Design : ---
Insulation class : F
Temperature rise : 80 K
Locked rotor time : 29 s (hot)
Service factor : 1.00
Duty cycle : S1
Ambient temperature : -20°C - +40°C
Altitude : 1000 m
Degree of Protection : IP55
Approximate weight : 4115 lb
Moment of inertia : 367.54 sq.ft.lb
Noise level : 77 dB(A)

	D.E.	N.D.E.	Load	Power factor	Efficiency (%)
Bearings	6322 C3	6319 C3	100%	0.81	96.2
Regreasing interval	11000 h	13000 h	75%	0.77	95.8
Grease amount	60 g	45 g	50%	0.67	95.4

Notes:

Performed by

Checked



No.:

Date: 08-MAR-2018

PERFORMANCE CURVES RELATED TO RATED OUTPUT Three-phase induction motor - Squirrel cage rotor

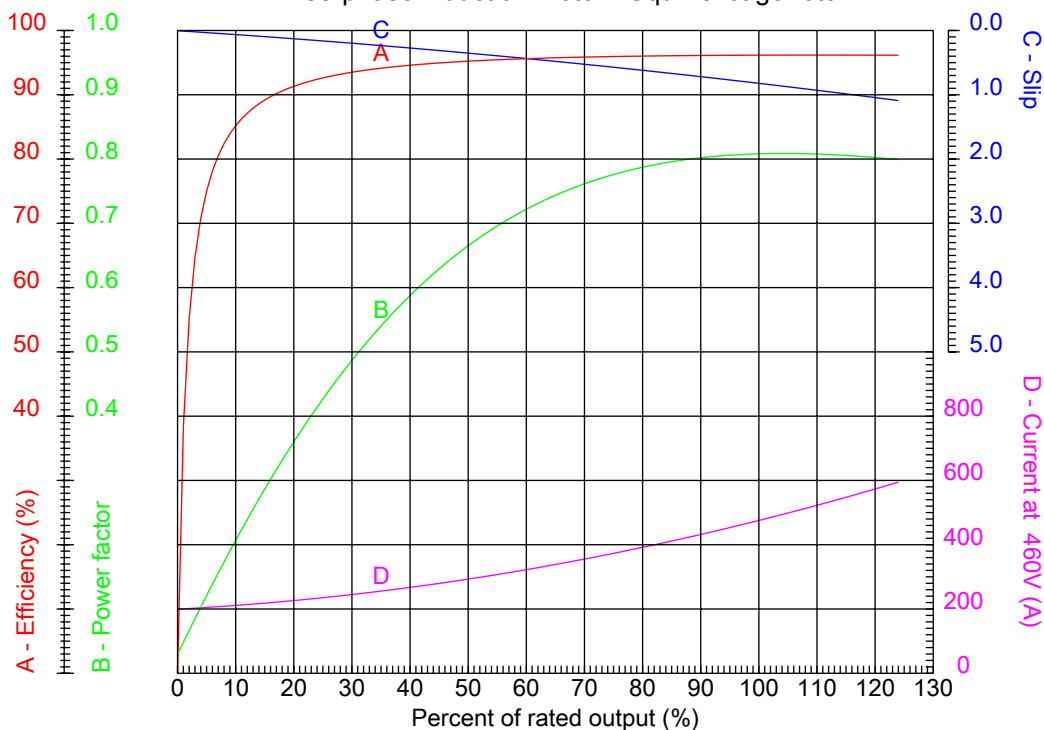

Customer :
Product line : W22 NEMA Premium - Ball Bearings

Frame	: 586/7T	Locked rotor current (I _l /I _n)	: 6.0
Output	: 400 HP	Duty cycle	: S1
Frequency	: 60 Hz	Service factor	: 1.00
Full load speed	: 1190 rpm	Design	: ---
Voltage	: 460 V	Locked rotor torque	: 220 %
Rated current	: 483 A	Breakdown torque	: 210 %
Insulation class	: F		

Notes:

Performed by

Checked



No.:

Date: 08-MAR-2018

CHARACTERISTIC CURVES RELATED TO SPEED

Three-phase induction motor - Squirrel cage rotor

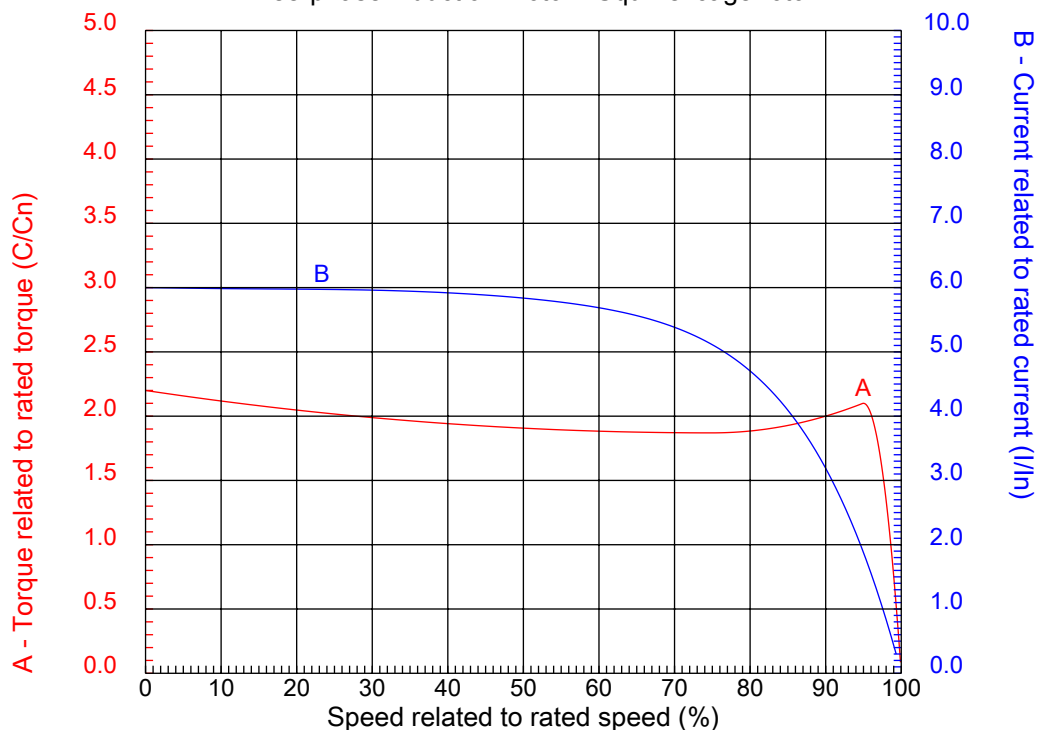

Customer :
Product line : W22 NEMA Premium - Ball Bearings

Frame	: 586/7T	Locked rotor current (I _l /I _n)	: 6.0
Output	: 400 HP	Duty cycle	: S1
Frequency	: 60 Hz	Service factor	: 1.00
Full load speed	: 1190 rpm	Design	: ---
Voltage	: 460 V	Locked rotor torque	: 220 %
Rated current	: 483 A	Breakdown torque	: 210 %
Insulation class	: F		

Notes:

Performed by

Checked

1 2 3 4 5 6 7 8

A

B

C

D

E

F

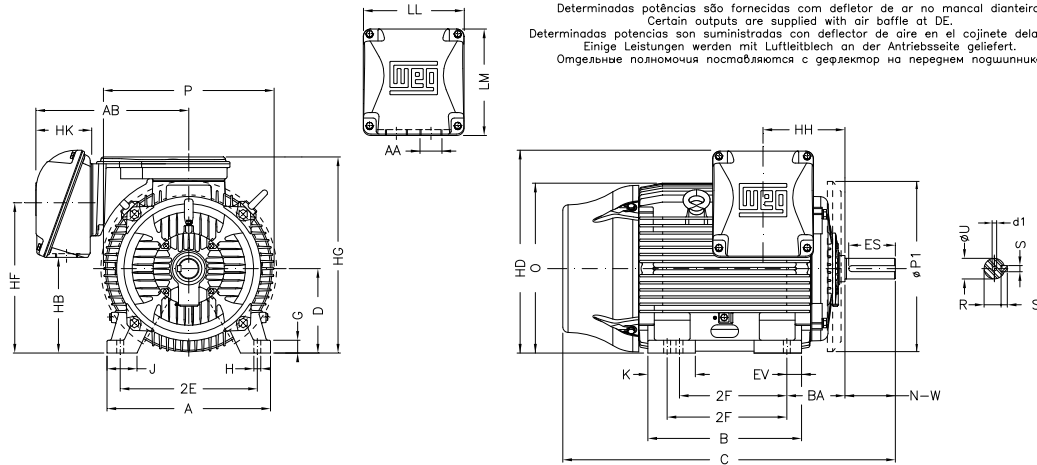

Determinadas potências são fornecidas com defletor de ar no mancal dianteiro.
 Certain outputs are supplied with air baffle at DE.
 Determinadas potencias son suministradas con deflector de aire en el cojinete delantero.
 Einige Leistungen werden mit Luftleitblech an der Antriebsseite geliefert.
 Отдельные полнomoчия поставляются с дефлектор на переднем подшипнике.

Notes:

2E 23.000	J 5.512	A 29.528	P 28.977	AB 23.189
2F 22.000/25.000	K 9.055	B 29.921	BA 10.000	U 3.875
N-W 11.625	ES 8.661	S 1.000	R 3.312	depth 1.000
D 14.500	G 2.492	HB 18.575	O 28.985	HD 35.740
HF 26.732	HG 35.236	HH 13.346	HK 8.661	EV 2.559
H 1.181	C 61.902	LL 15.906	LM 17.165	AA 2xNPT 3"
d1 DUNC 7/8"-9				

Performed by:

Checked:

Customer:

W22 NEMA Premium - Ball Bearings

Three-phase induction motor
 Frame 586/7T - IP55

08-MAR-2018



1 2 3 4 5 6 7 8

A

PART-WINDING

WYE-DELTA

START

RUN

START

RUN

B

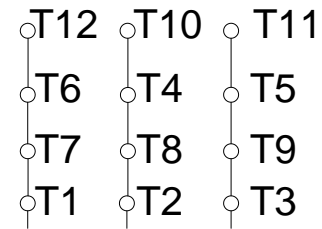
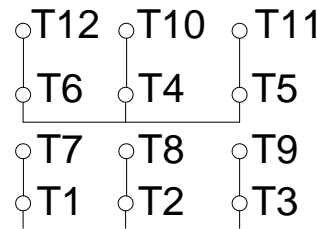
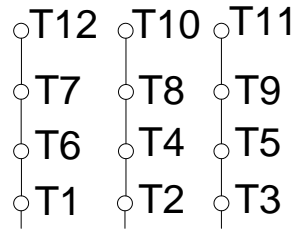
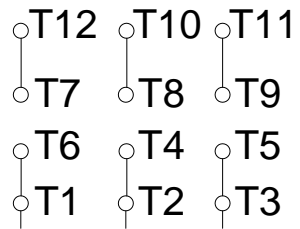

C

L1 L2 L3

L1 L2 L3

L1 L2 L3

L1 L2 L3

D

E

F

Notes:

Performed by:

Checked:

Customer:

W22 NEMA Premium - Ball Bearings

Three-phase induction motor
Frame 586/7T - IP55

08-MAR-2018

