

PORTS: 2X 3" FLANGES
 DRILLED AND TAPPED
 SUITABLE FOR USE WITH
 CLASS 250 ANSI FLANGES

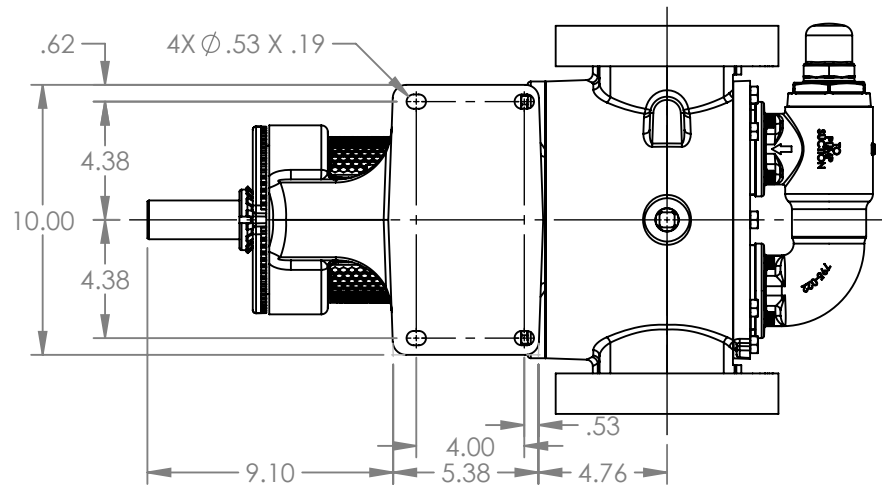

VIEW A-A

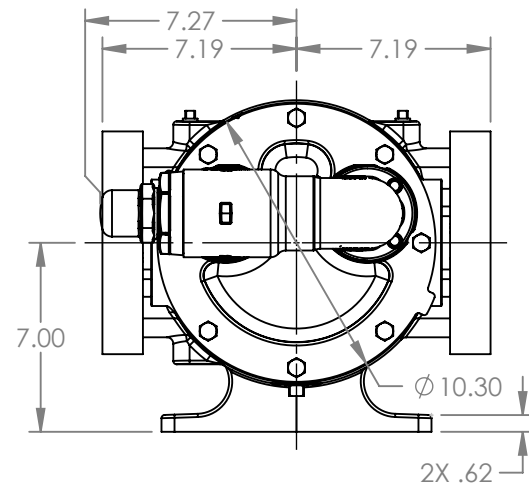
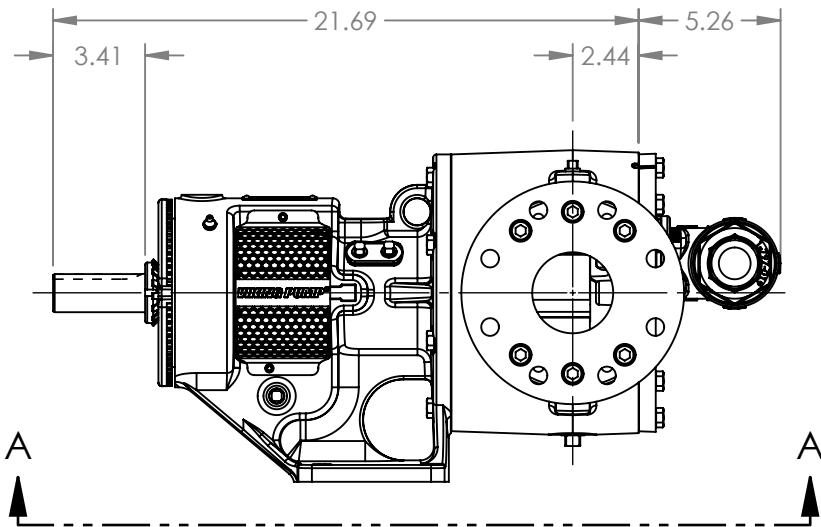

MODELS WITH OPTIONAL FLANGED PORTS:
 LS124C, LS1124C, LS4124C, LS4624C

NOTES:
 1. ALL DIMENSIONS ARE FOR REFERENCE ONLY.

STATE	Released	01/05/2026
DRAWN	aeverhardt	01/02/2026
CHECKED	DTL	01/05/2026

DIMENSIONS ARE IN
 INCHES
 PROJECT: E399
 WAS:



VIKING PUMP, INC.
 A Unit of IDEX Corporation
 Cedar Falls, IA 50613 U.S.A.
 VIKINGPUMP.COM

THIS DRAWING IS THE PROPERTY OF
 VIKING PUMP, INC. AND IS PROPRIETARY
 IN GENERAL AND DETAIL. IT SHALL NOT BE
 COPIED OR ITS CONTENTS REVEALED TO
 OUTSIDE PARTIES WITHOUT THE WRITTEN
 CONSENT OF VIKING PUMP, INC.

3D

DWG. NO.
 LV-4857

SHEET 1 OF 1

REV. A.0

01/05/2026