

VIEW A-A

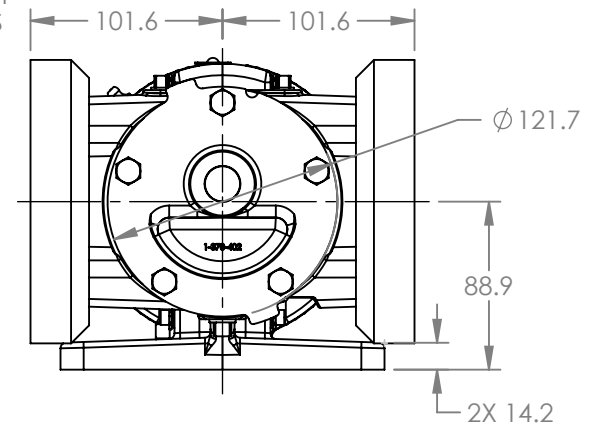
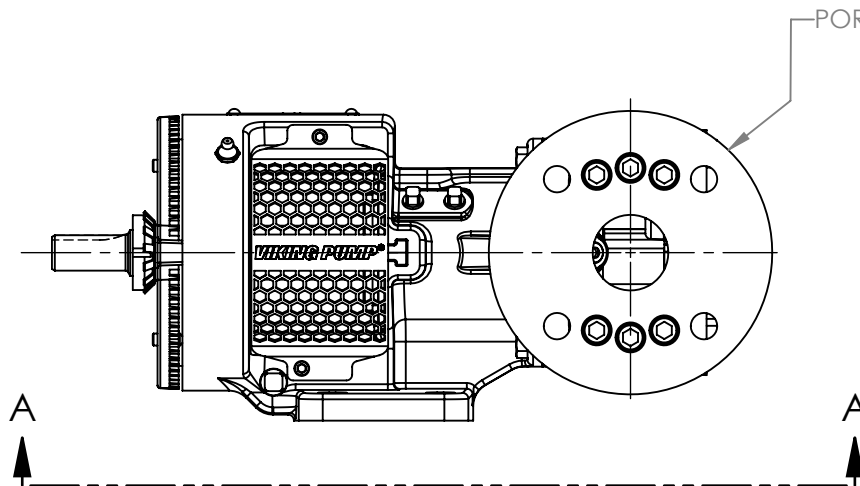

MODELS WITH OPTIONAL FLANGED PORTS:
 H123C, H4123C, H127C, H1127C, H4127C,
 HL123C, HL4123C, HL127C, HL1127C, HL4127C

NOTES:
 1. ALL DIMENSIONS ARE FOR REFERENCE ONLY.

STATE	Released	04/16/2024
DRAWN	dalcorn	07/24/2023
CHECKED	BAM	04/16/2024

DIMENSIONS ARE IN
 MILLIMETERS
 PROJECT E330
 WAS:



VIKING PUMP, INC.
 A Unit of IDEX Corporation
 Cedar Falls, IA, 50613 U.S.A.
 VIKINGPUMP.COM

THIS DRAWING IS THE PROPERTY OF
 VIKING PUMP, INC. AND IS PROPRIETARY
 IN GENERAL AND DETAIL. IT SHALL NOT BE
 COPIED OR ITS CONTENTS REVEALED TO
 OUTSIDE PARTIES WITHOUT THE WRITTEN
 CONSENT OF VIKING PUMP, INC.

3D

DWG. NO.
 HV-4220

SHEET 1 OF 1

REV. A.1

04/16/2024