

.25 SQUARE KEY  
1.25 LONG

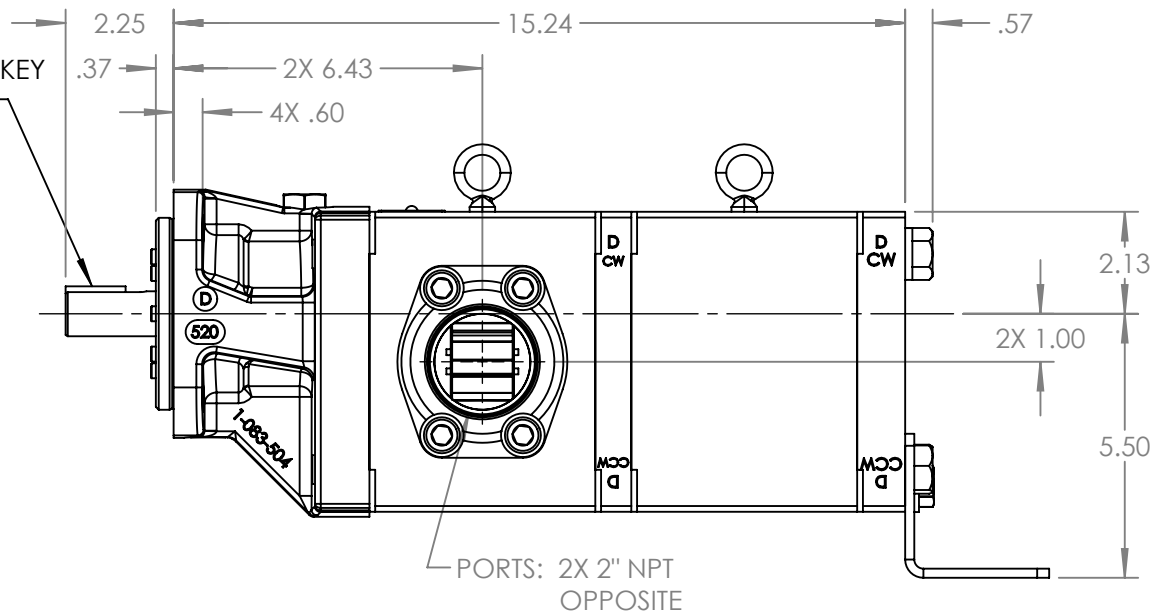

NOTES:

1. ALL DIMENSIONS ARE FOR REFERENCE ONLY.

STANDARD MODELS: GB-41026-G00, GB-41026-G10

STATE	Released	07/16/2021	DIMENSIONS ARE IN INCHES
DRAWN	bmanternach	6/15/2021	
CHECKED	JAG	07/16/2021	
PROJECT: E331			WAS: EX-E331-502



**VIKING PUMP, INC.**  
A Unit of IDEX Corporation  
Cedar Falls, IA 50613 U.S.A.  
VIKINGPUMP.COM

THIS DRAWING IS THE PROPERTY OF  
VIKING PUMP, INC. AND IS PROPRIETARY  
IN GENERAL AND DETAIL. IT SHALL NOT BE  
COPIED OR ITS CONTENTS REVEALED TO  
OUTSIDE PARTIES WITHOUT THE WRITTEN  
CONSENT OF VIKING PUMP, INC.

**3D**

DWG. NO. GPV-1026-073-U  
SHEET 1 OF 1

REV. A.0  
07/16/2021