



 **PANDA**
WINDOWS & DOORS



What makes Panda Different?

Complete focus on custom luxury windows and doors. Award-winning designs. Engineering solutions for complex projects. Proprietary hardware and extrusions.

We use the finest hardware from the leading manufacturers around the world. Many products are NFRC, AAMA, and Impact rated.

Panels available in massive dimensions, up to 24' tall or 16' wide. Energy efficient products support LEED® and Title 24 compliance.

Quality

Precision engineering and the finest craftsmanship

Materials

Aluminum, Steel, Stainless Steel, Bronze, and Wood

Customization

Unlimited features and options to meet your every need

Service

Dedicated support staff and engineers at your service

Quality

Engineering and Craftsmanship

We've been designing European-inspired windows and doors for over 30 years, catering to custom luxury residential and commercial projects.

Our dedicated team of engineers focuses on innovation and excellence, delivering industry-leading, premium-grade products.



Materials

Extrusions and Hardware

We source only the finest materials from the leading suppliers around the world. Products are made from abundantly available, highly recyclable, and sustainable materials.

Our hardware is designed in-house and features patented innovations, guaranteeing exceptional product fidelity and performance.



Custom

Bespoke and Innovative

Choose from over 80 state-of-the-art products, including sliding, folding, stacking, swinging, and pivoting options, all customizable to your exact specifications.

Select premium features such as automation, smart home integration, biometric smart locks, smart glass technology, and much more.



Service

Tailored and Reliable Support

An experienced team is just a call or a click away. So whether you need onsite support, a replacement part, or guidance over the phone, we're committed to resolving the issue quickly.

Exceptional customer support backed by a 10-year Warranty. Enjoy your windows, your doors, and your peace of mind.



PHILOSOPHY

Design stunning, premium products with an unwavering commitment to the finest materials and craftsmanship.

ALUMINUM

STEEL

STAINLESS STEEL

ARCHITECTURAL BRONZE

WOOD

M A T E R I A L S

Aluminum

A highly versatile material capable
of a wide range of shapes and
finishes

- Affordable and low-maintenance
- Durable and highly customizable
- Thermally broken and energy efficient
- Sustainable and highly recyclable



Steel

Sleek and incredibly thin profiles that deliver unmatched durability and timeless elegance

- Exceptional strength and structural support
- Forced entry and fire resistant
- Industrial and contemporary design aesthetic
- Superior thermal efficiency
- Sustainable and highly recyclable



Stainless Steel

The luxurious and ultra-modern analog of steel, providing unparalleled elegance and allure

- Exceptional strength and structural support
- Outstanding rust and corrosion resistance
- Forced entry and fire resistant
- Superior thermal efficiency
- Sustainable and highly recyclable



Architectural Bronze

A warm and inviting aesthetic with many of the same benefits of steel

- Exceptional strength and structural support
- Unparalleled rust and corrosion resistance
- Durable and low-maintenance
- Energy efficient and thermally broken
- Sustainable and highly recyclable



Wood

Naturally beautiful and full of character without compromising performance

- Durable and highly customizable
- Timeless and naturally inviting character
- Natural thermal and sound insulation
- Sustainable and highly recyclable



FINISHES

Powder Coat

Choose from 25 Powder Coat colors available in AAMA 2604/2605, Metallic/Bonded, and DURANAR®. Can't find the perfect color? We can color-match any color.

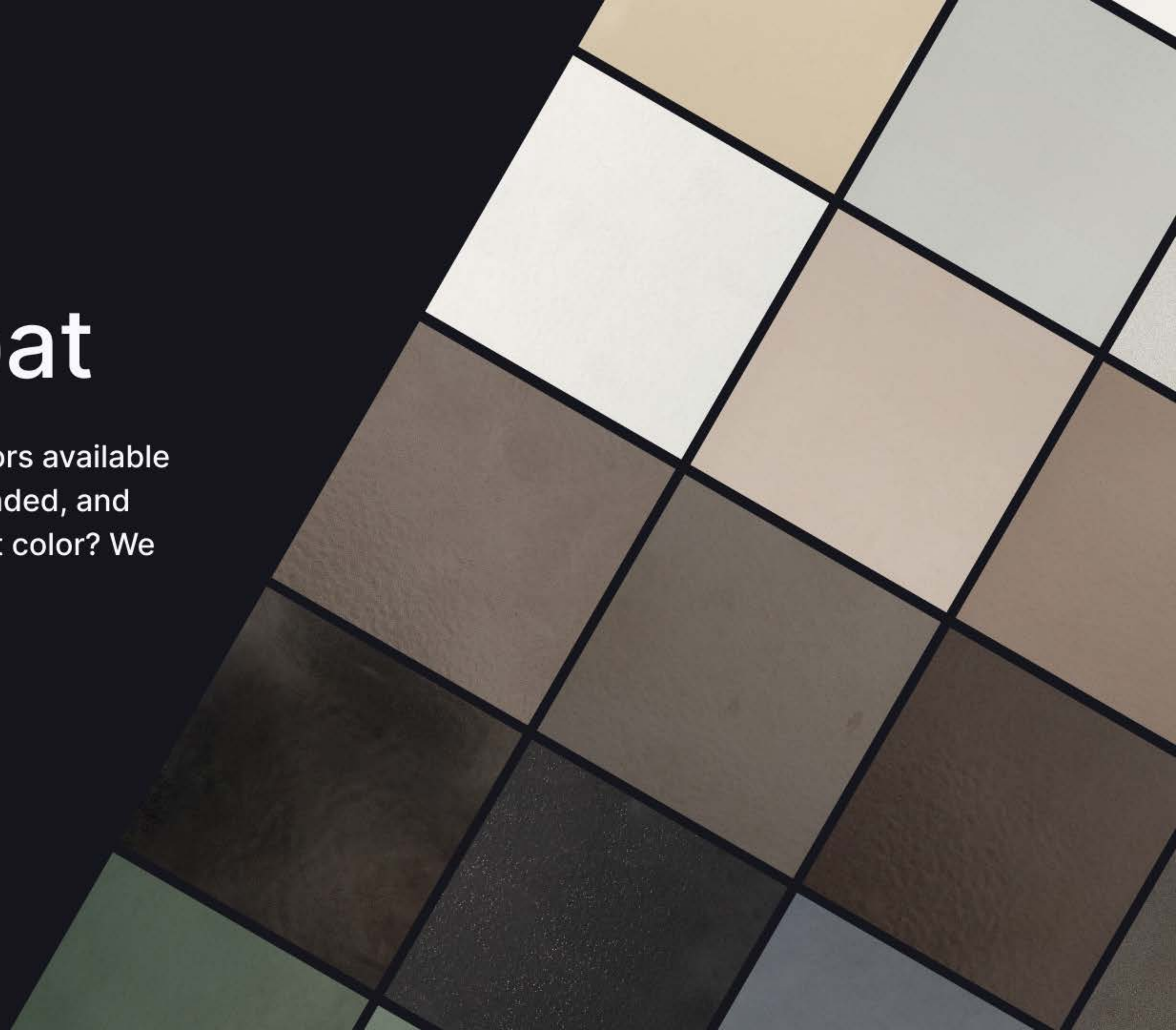



Kynar Paint

Renowned for its exceptional color retention and sun-resistance, Kynar Paint stays vibrant even in the harshest climates.

Anodized

For best-in-class corrosion resistance and durability,
ideal for coastal applications. Choose from 9
Anodized colors or color-match any color.

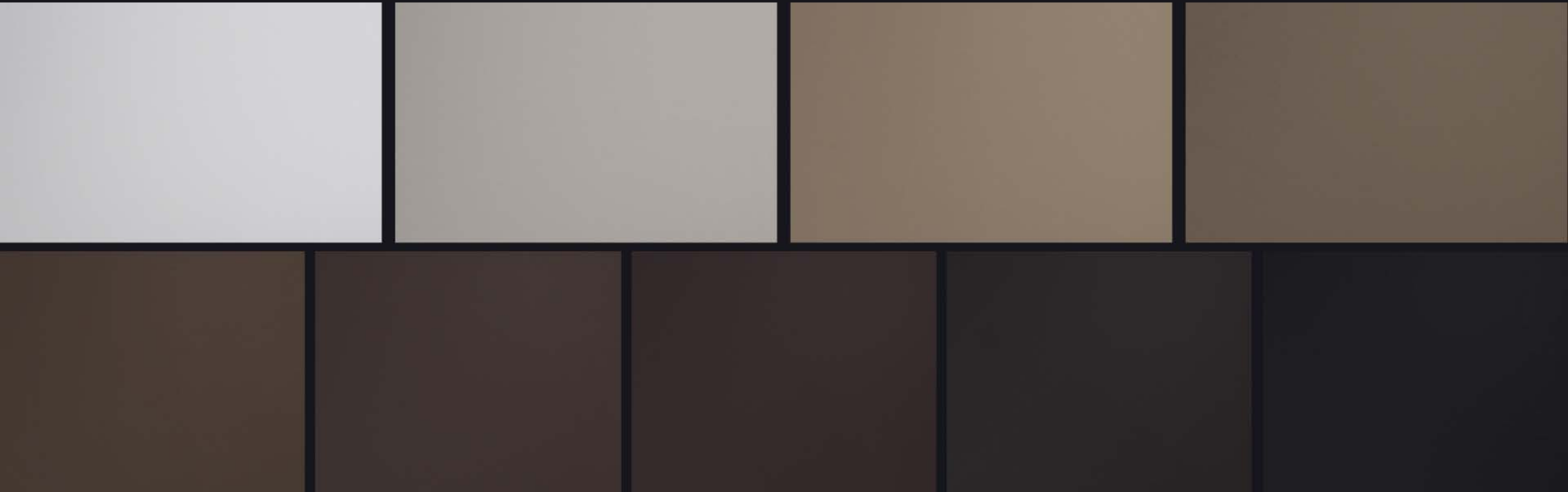

Wood

Choose from timeless classics like Pine or Poplar, or the warmth and richness of exotic species.

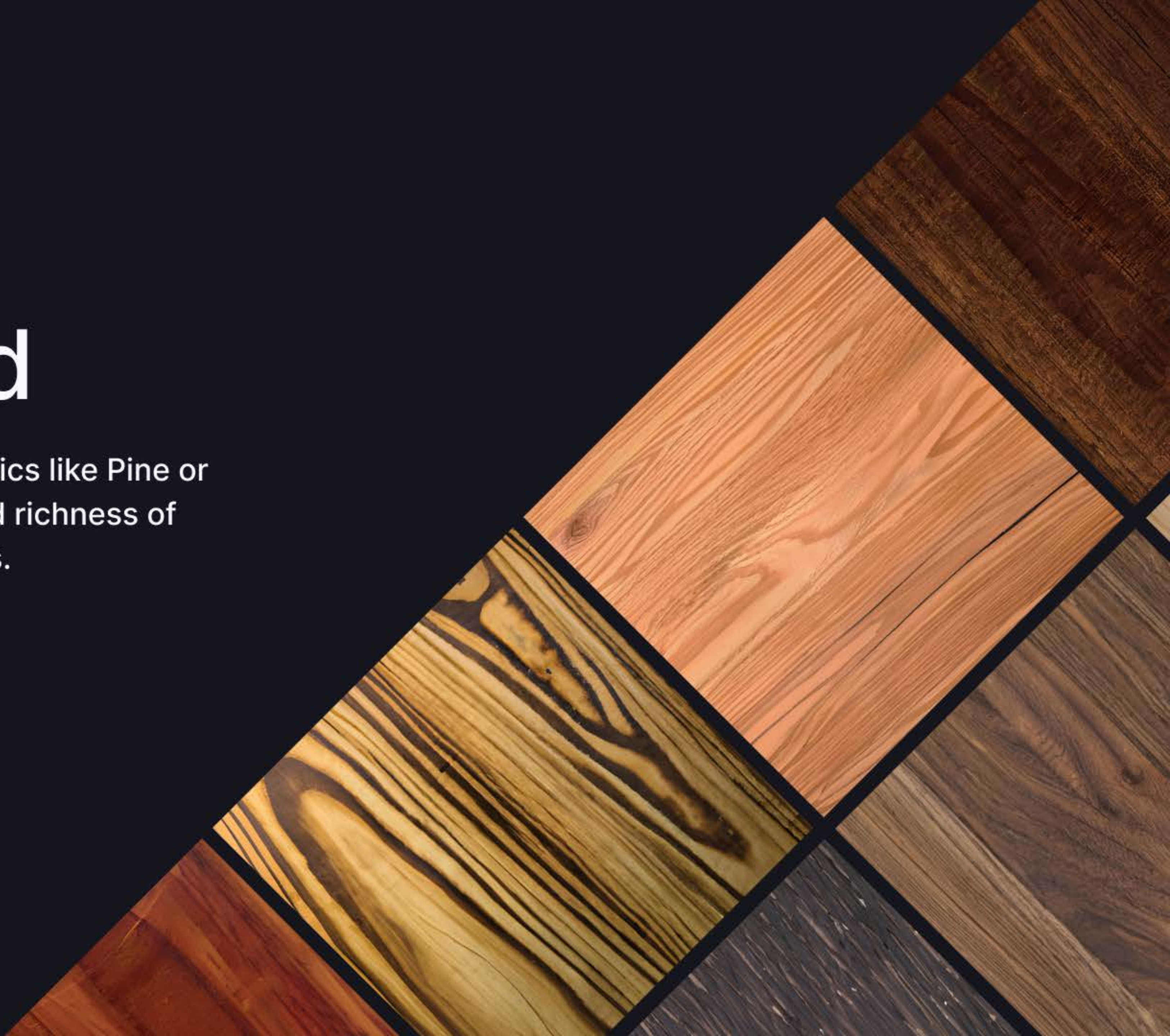



Faux Wood

For those who love the rich texture and natural look of real wood, but need the durability of aluminum.

Steel

Choose from 18 RAL wet paint colors or color-match any color for a finish that's built to last a lifetime.

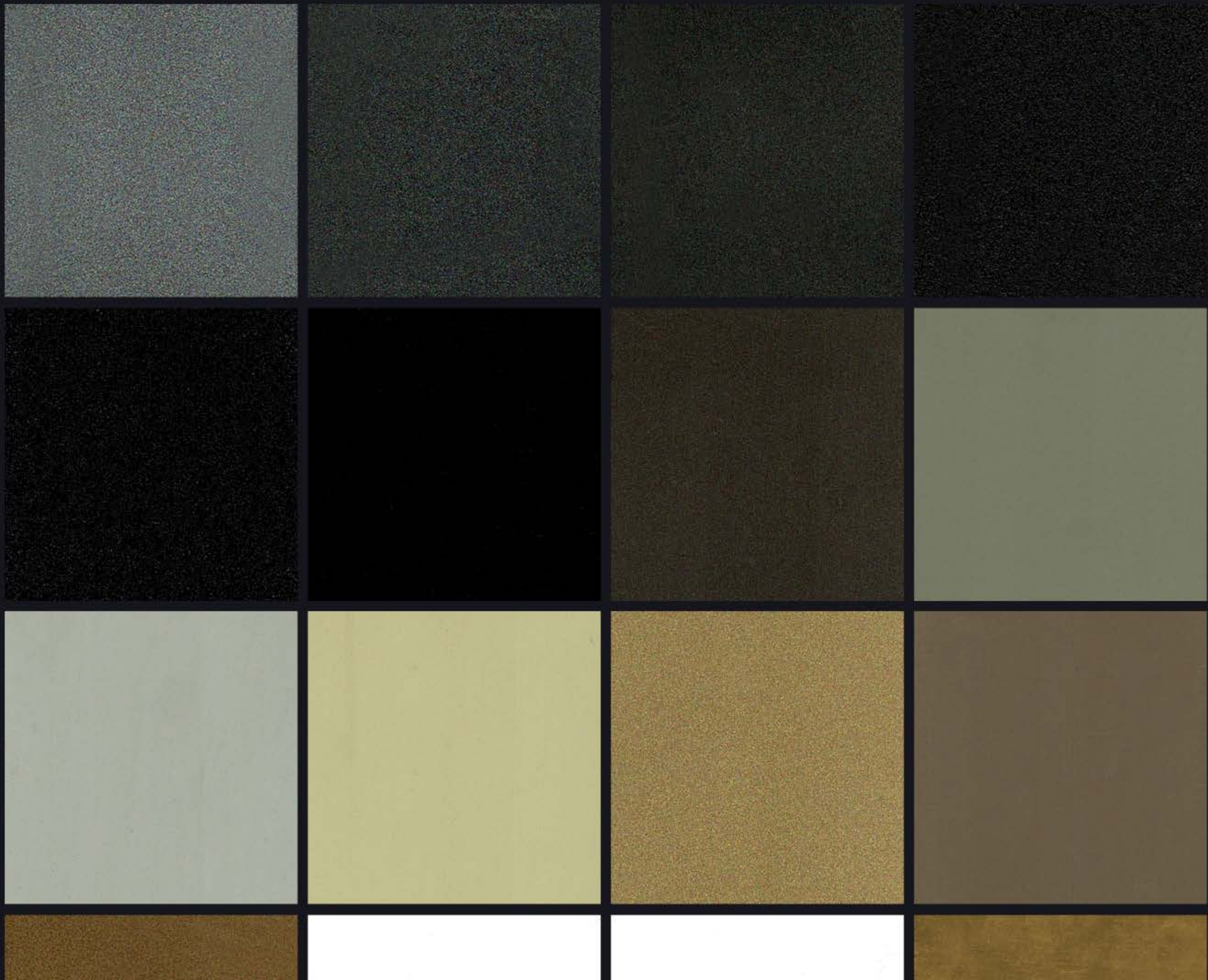

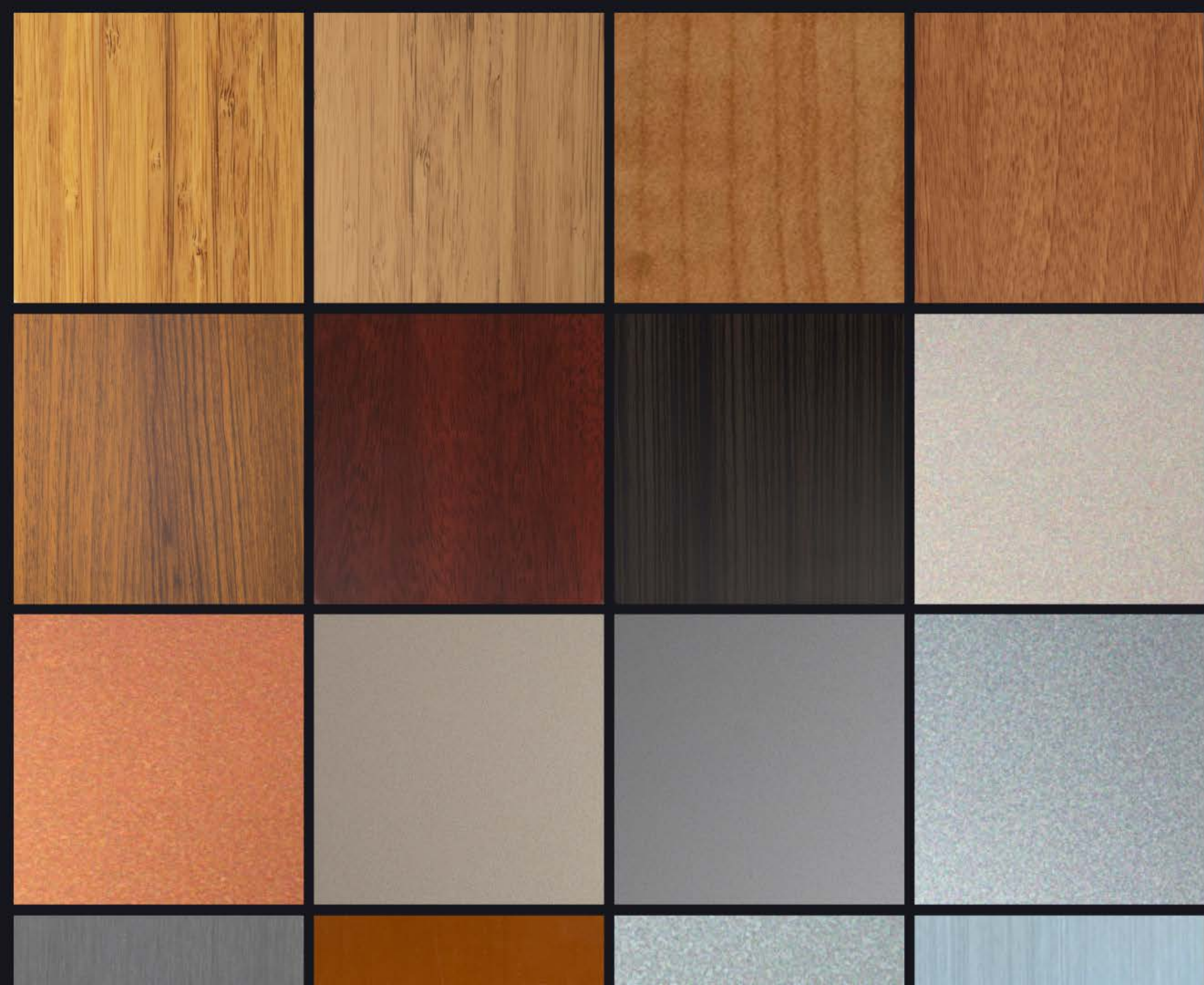

ACM

Make a grand entrance with more than 50 ACM colors, available in metallic, matte, glossy, or prismatic sheen. If you have a specific color in mind, we can color-match any color.

**SPECIALTY
PRODUCT LINES**



Voyage Collection

Transform your entryway with **the award-winning Voyage Collection** line of premium pivot doors. Each door is a masterpiece, offering endless design options to create a truly remarkable and opulent entryway.

Voyage Collection pivot doors can soar to an **astounding 24' in height**, feature recessed LED lights, biometric smart locks, automated drop seals, and are HVHZ-approved for use in Florida.



Bespoke Designs

14 designs inspired by some of the most beautiful destinations in the world:

Rio, San Carlos, Manila, Paris, Sydney, Sequoia, Auckland, Bondi, London, Petra, Ibiza, Melbourne, Fiji, and Tokyo.



Specialty Surfaces

One-of-a-kind designs made with specialty materials like Nickel, Pewter, Terracotta, and Graphite. The possibilities are endless.



VOYAGE COLLECTION

Handles



One (Minimal)



Seattle (Minimal)



Wonder (Minimal)



Phoenix (Slim)

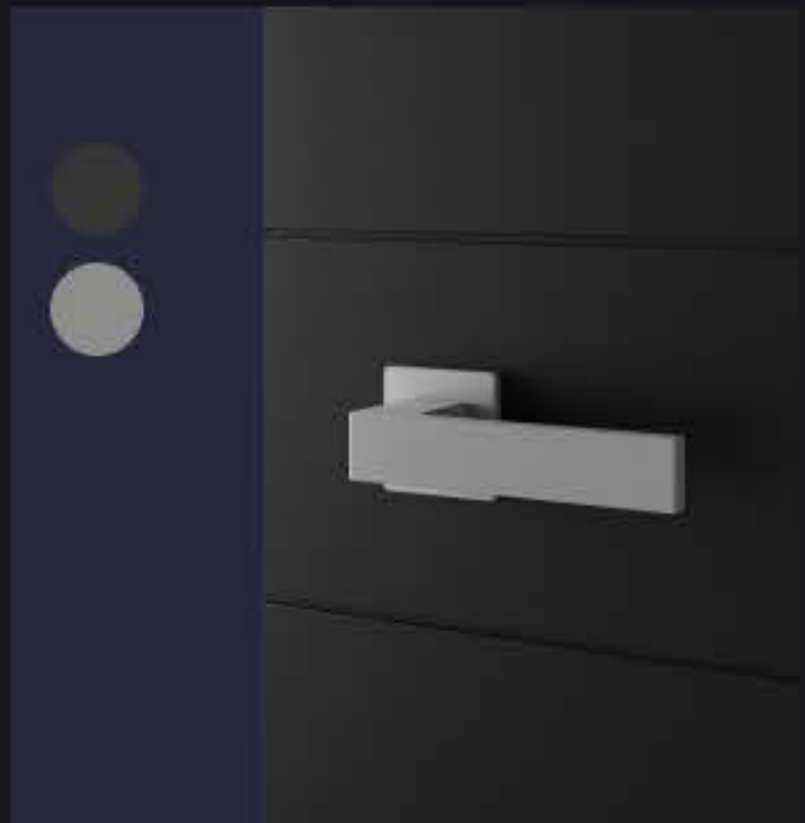

Seattle (Slim)



Seoul (Slim)



Round Ladder Pull



Round Ladder Pull
+ Fingerprint Scanner



Square Ladder Pull



Square Ladder Pull
+ Fingerprint Scanner



LED Recessed Handle



Smart Handle

Odyssey Collection

Elevate your home's grandeur with the **Odyssey Collection** line of hinged door masterpieces. Inspired by the success of the Voyage Collection, the Odyssey Collection offers the same imaginative designs, unparalleled design flexibility, premium materials, and advanced features.

Odyssey Collection hinged doors can stand up to **12' tall and 42" wide** and make no compromises in the hardware or designs that have made the Voyage Collection an established name in bespoke architecture.





X0 Slim-Line

Enjoy breathtaking views with **the award-winning X0 Slim-Line**, a premium line of multi-slide doors. Choose between the TS.X0 and the Tavi.X0 for different performance and budgetary needs, without compromising on the sleek design.

The X0 Slim-Line offers the narrowest sightlines in the industry - just 15/16" at the interlock, **can reach 20' in height or 16' in width**, boasts multi-point locks, and industry-leading performance with HVHZ-approval for use in Florida.



X0 SLIM-LINE

TS.X0

TAVI.X0

Maximum Panel Height	240"			180"		
Maximum Panel Width	200"			120"		
Stile	15/16"			15/16"		
Rail	15/16"			1 15/16"		
Tracks	Multiple Recessed Drainage Tracks			Surface and Recessed Drainage Tracks		
Highlights	Thermally Broken	Impact Rated	NFRC Tested	Thermally Broken	Impact Rated	NFRC Tested

TS.X0

Tracks



2 1/2" Recessed Drainage Track



2 1/2" ADA Recessed Drainage Track

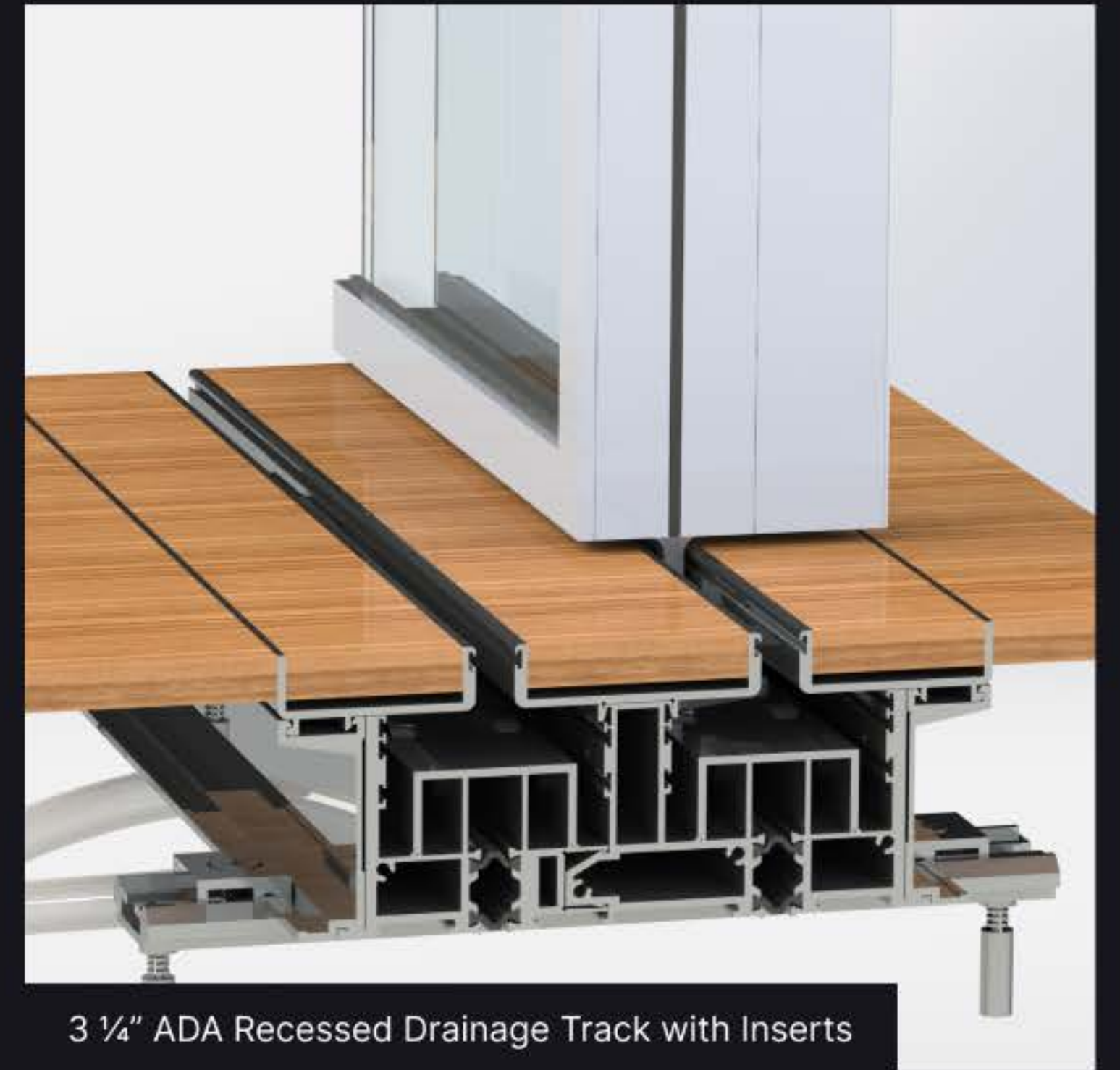

3 1/4" ADA Recessed Drainage Track with Inserts

TAVI.X0

Tracks



1 1/8" Surface Drainage Track



1 1/4" Recessed Track



1 1/4" Recessed Drainage Track

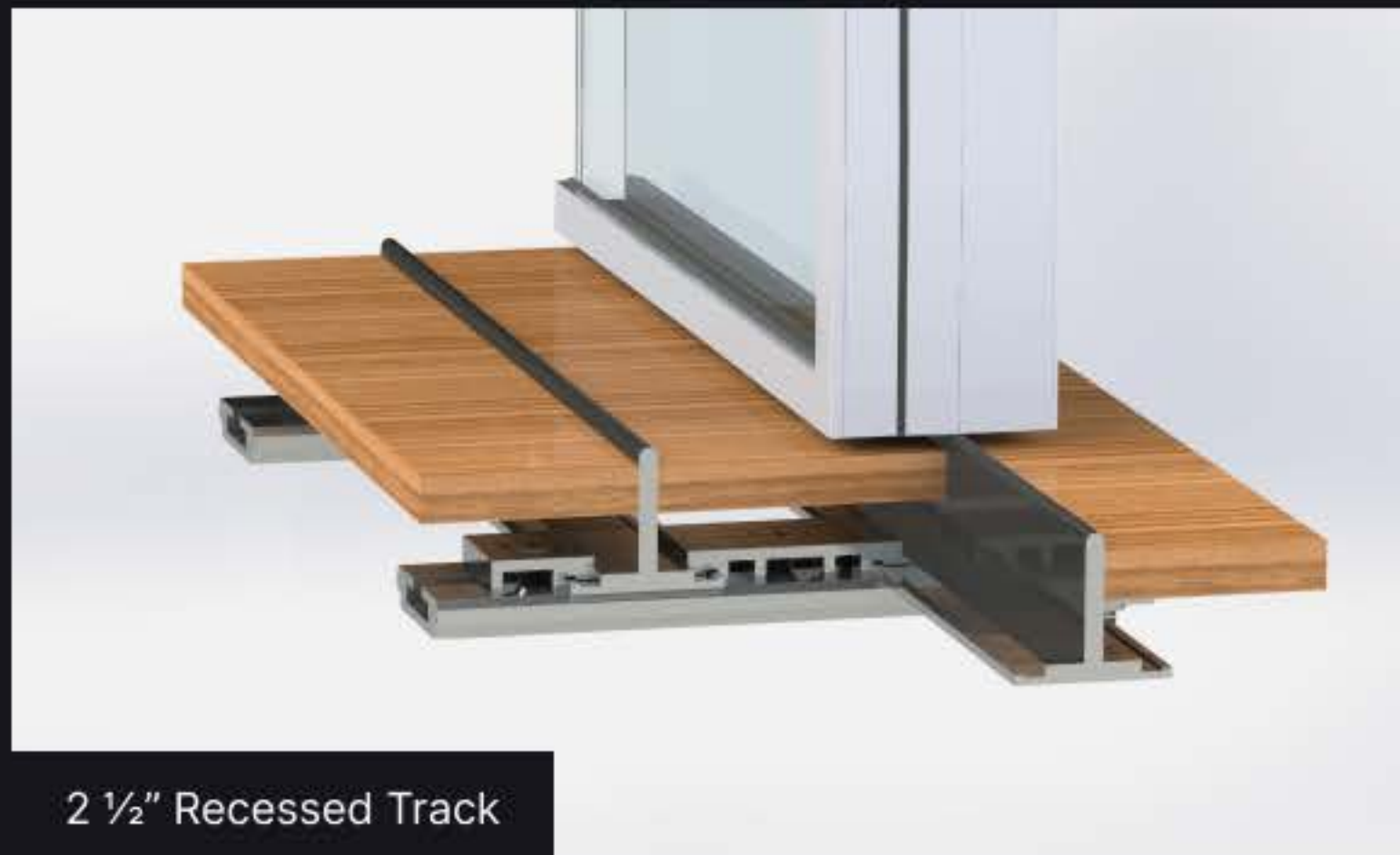

2 1/2" Recessed Track

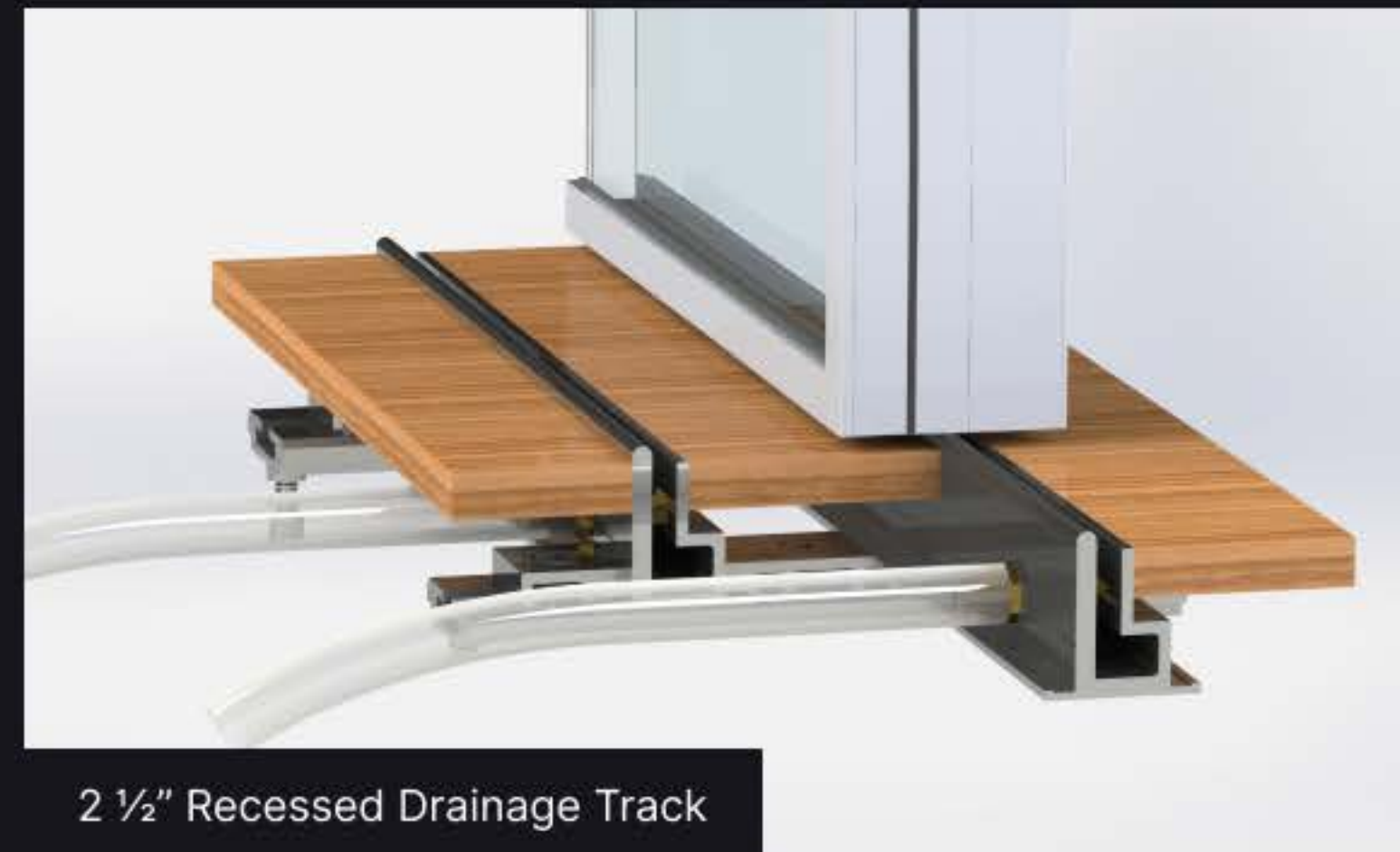

2 1/2" Recessed Drainage Track

PandaSelect

(Budget Friendly)

Experience Panda's exceptional craftsmanship and **sleek designs at an affordable price**. Enjoy the beauty of large windows and doors custom-built to your specifications, without breaking your budget.

The popular **PandaSelect line features Lift & Slides, Multi-Slides, and Hinged Doors** with the same robust weather resistance, security, and energy efficiency of our premium systems, at an affordable price.



PandaSelect Lift & Slide

- For best-in-class weather resistance, security, and incredible views
- Panels can reach 12' in height or 9' in width
- Available in: Aluminum and Aluminum-Wood Clad
- Surface, recessed, and drainage tracks available
- Thermally broken and ADA compliant options



PANDASELECT LIFT & SLIDE

Tracks



5/16" Surface Track



1 1/8" Surface Drainage Track



1 1/4" Recessed Track



1 1/4" Recessed Drainage Track



2 1/2" Recessed Track



2 1/2" Recessed Drainage Track



2 1/2" Recessed Drainage Track with Retention Track

PANDASELECT LIFT & SLIDE

Handles



PandaSelect Multi-Slide

- The perfect choice for exceptionally wide spaces or views that cannot be compromised
- Panels can reach 12' in height or 9' in width
- Available in: Aluminum and Aluminum-Wood Clad
- Surface, recessed, and drainage tracks available
- Thermally broken options



PANDASELECT MULTI-SLIDE

Tracks



5/16" Surface Track



1 1/8" Surface Drainage Track



1 1/4" Recessed Track



1 1/4" Recessed Drainage Track



2 1/2" Recessed Track



2 1/2" Recessed Drainage Track



2 1/2" Recessed Drainage Track
with Retention Track

PANDASELECT MULTI-SLIDE

Handle



Tev500

PandaSelect Hinged

- A mainstay feature of commercial and residential builds, now with slender profiles
- Doors can reach 12' in height and 42" in width
- Available in: Aluminum and Aluminum-Wood Clad
- Surface thresholds with ADA compliant options
- Thermally broken options



Thresholds



No Threshold



$\frac{3}{8}$ " ADA Surface Threshold



$1\frac{7}{8}$ " Surface Threshold (Inswing)



$1\frac{7}{8}$ " Surface Threshold (Outswing)

PANDASELECT HINGED DOOR

Handles

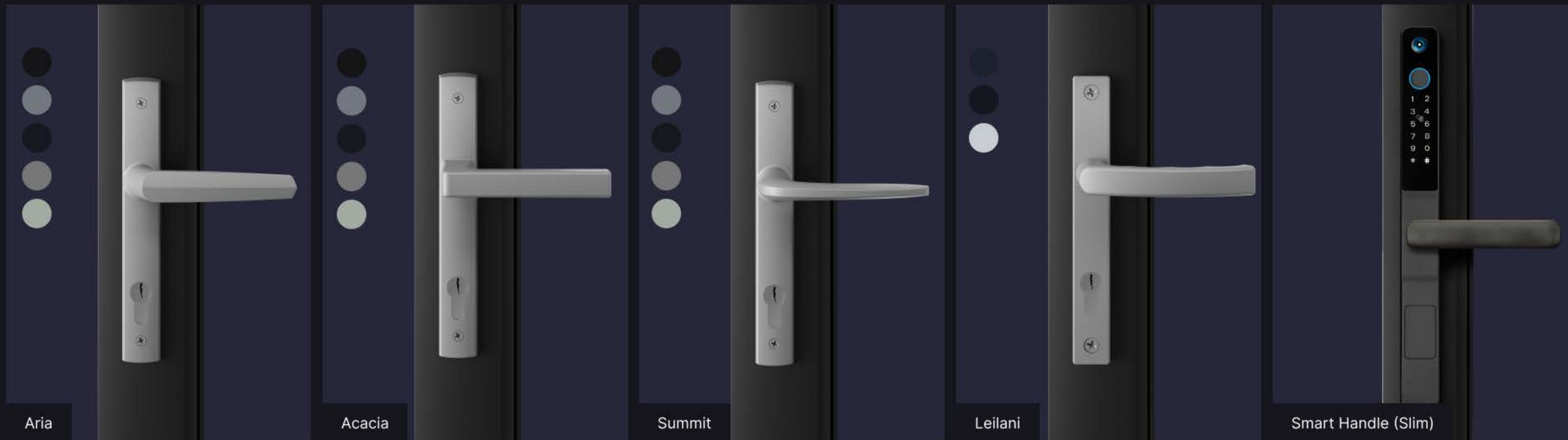

Aria

Acacia

Summit

Leilani

Smart Handle (Slim)

C O R E P R O D U C T S

Folding Doors

- Effortlessly stack and fold to create expansive living spaces and an uninterrupted connection to the outdoors
- Panels can reach 14' in height and 40" in width
- Available in: Aluminum, Steel, Aluminum-Wood Clad, and Solid Wood
- Top-hung and floor-supported options
- Surface, recessed, and drainage tracks available
- Thermally broken options

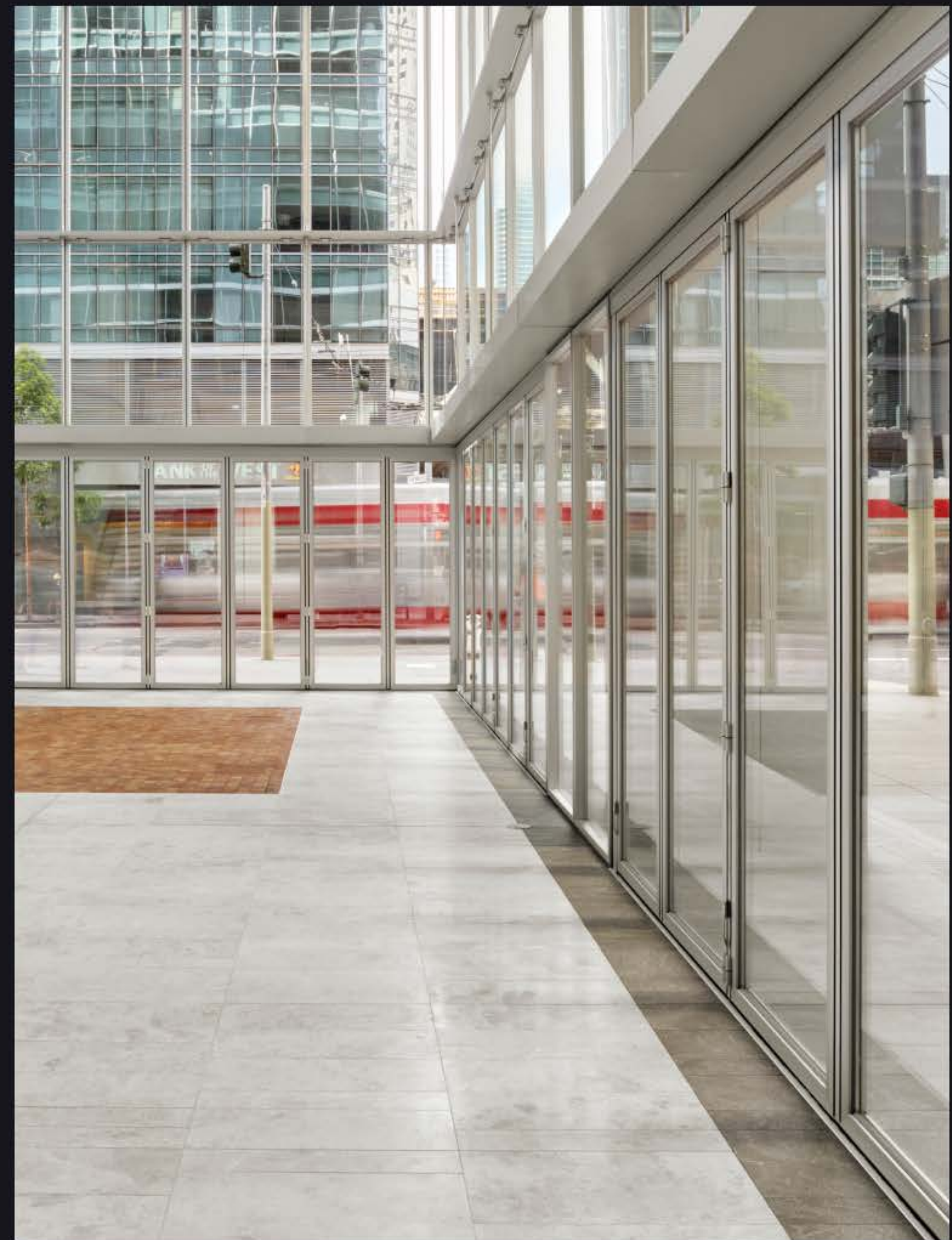

**Why choose Panda's
folding doors?**

Sweeping Views

Frames up to 24' wide feature up to 8 panels, while larger frames come in a bi-part system up to 16 panels (8L-8R), creating a stunning 48' frame.

Even larger

Frames exceeding 48' in width, panels are grouped into 4 or 6 floating panels, allowing virtually infinite frame widths.



Pinch Proof

Panda's folding doors feature a pinch-proof design, ensuring safety around children and making them perfect for commercial spaces.

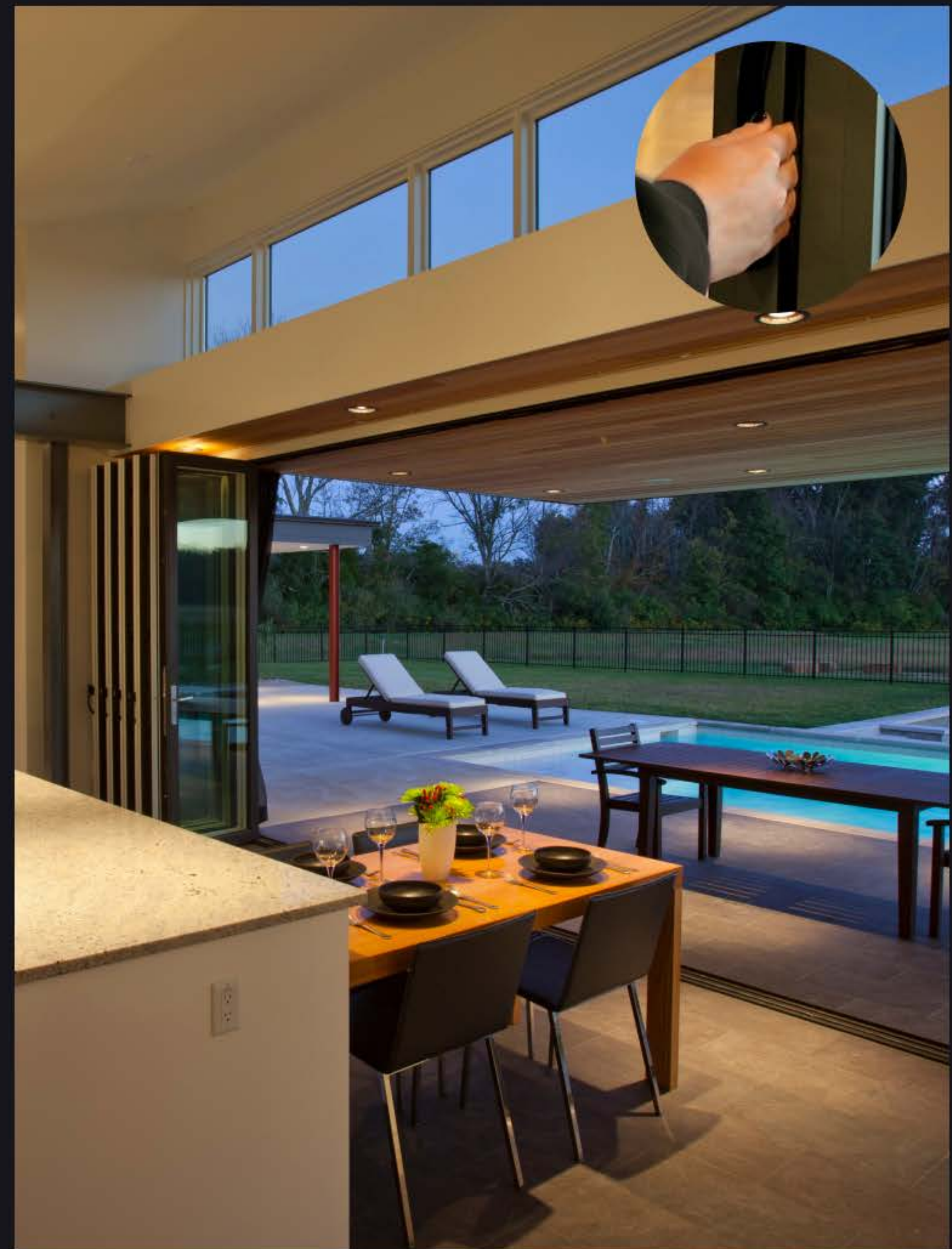

Secure

Folding doors come standard with concealed multi-point locks for added security. Panels up to 10' tall feature a three-point lock, while taller doors boast a four-point lock.

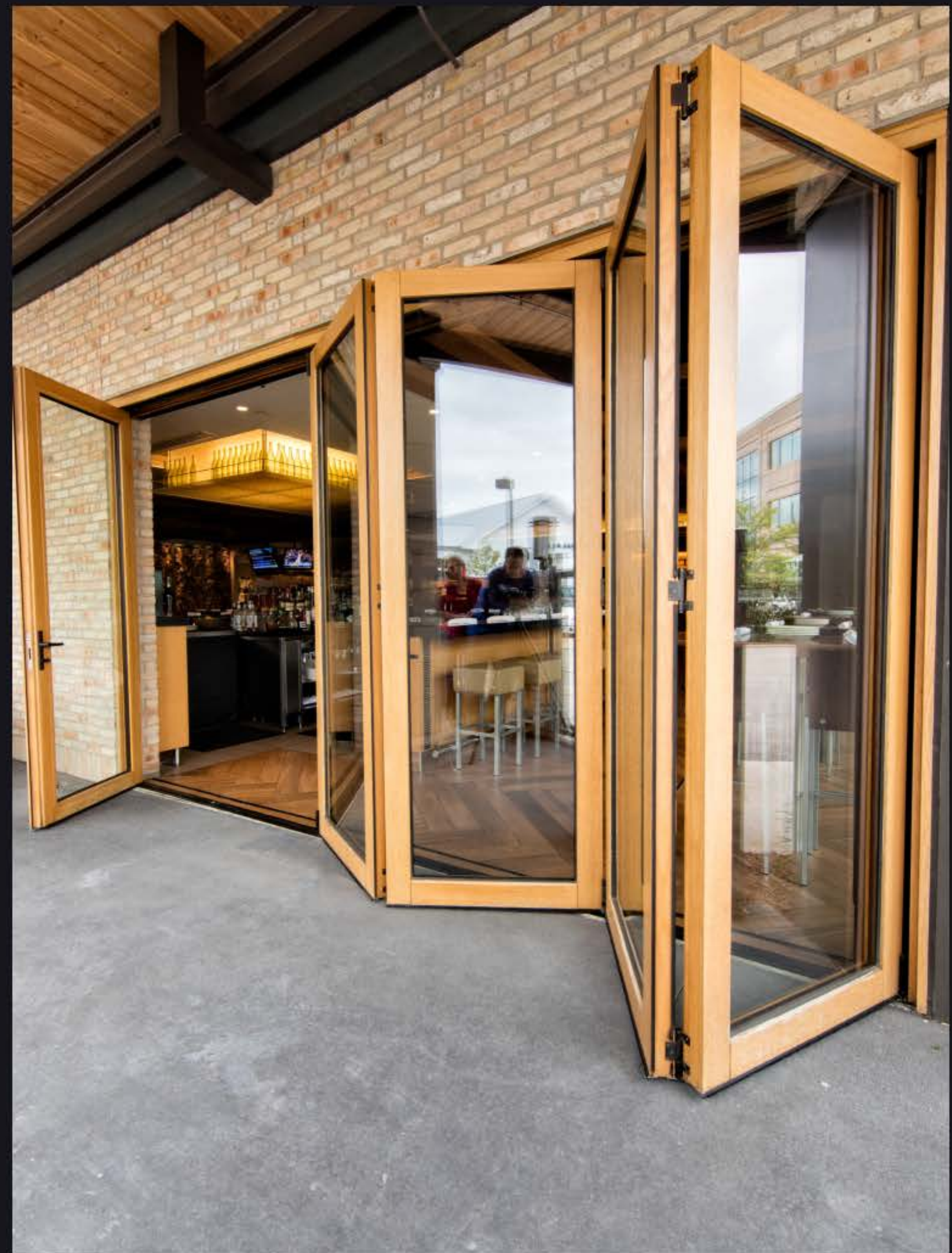

Customization Options

FOLDING DOOR

Configurations

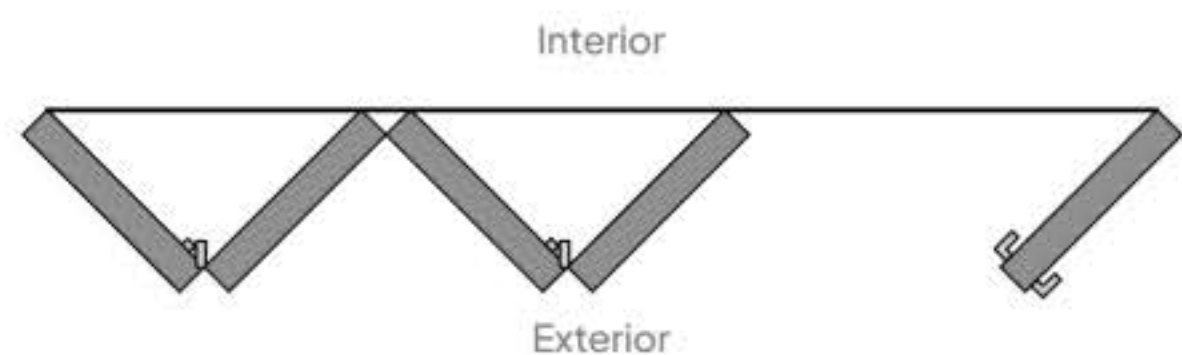

4L - 1R



6L - 7R

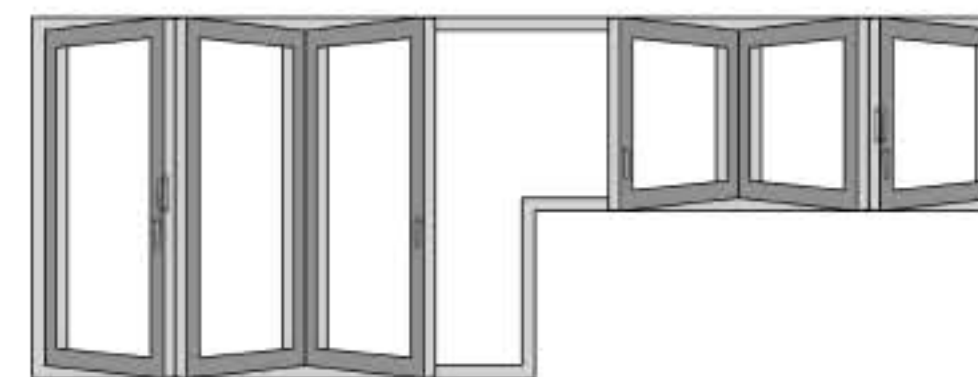

Exterior view. Outswing.
Hardware shown for illustration only.

FlexCounter

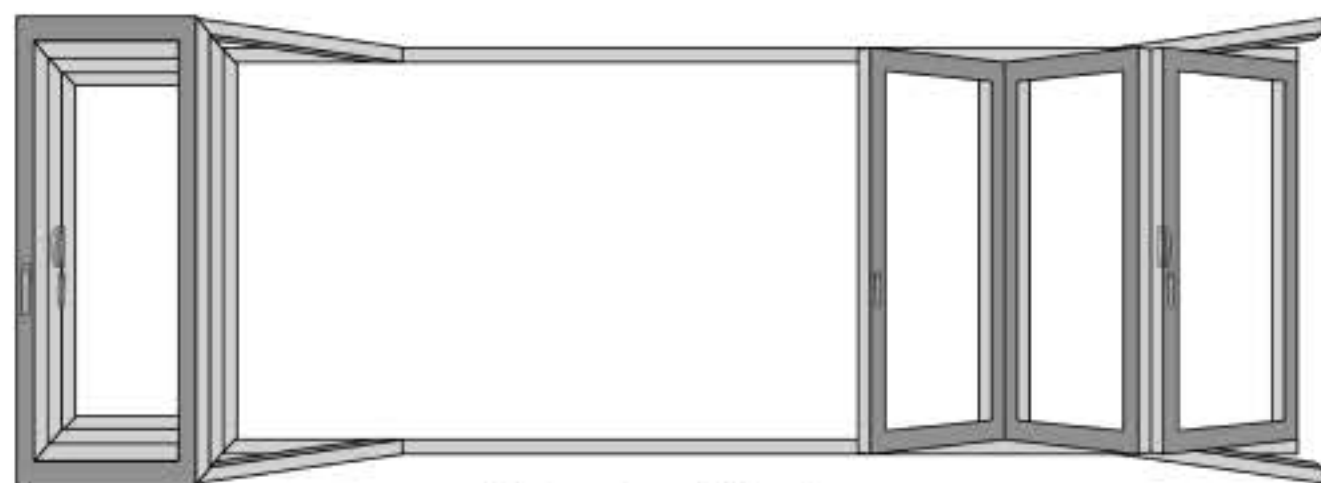

Exterior view. Outswing.
Hardware shown for illustration only.

Hidden Panels

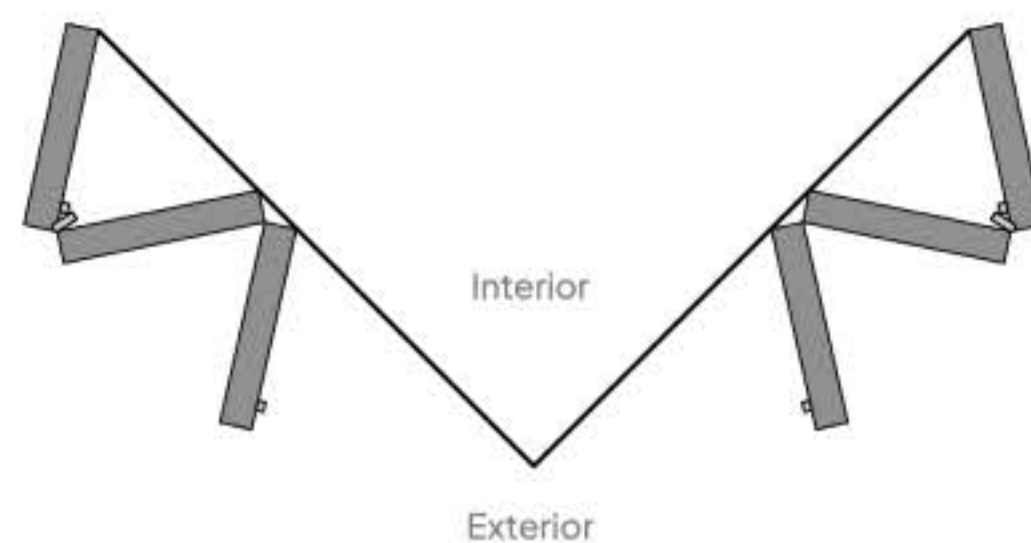

Zero-Post Corner

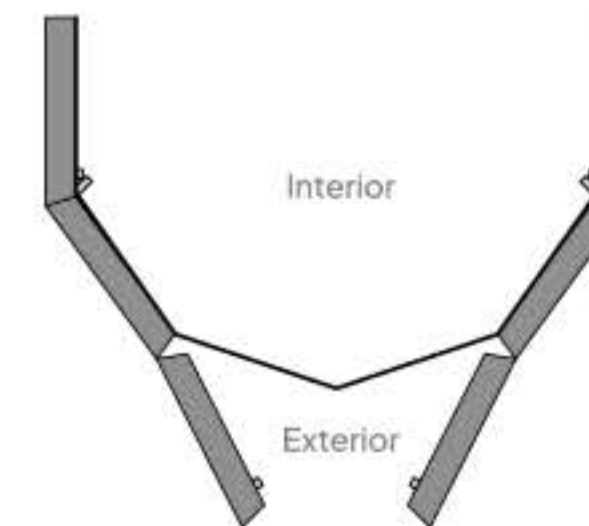

Segmented Radius

FOLDING DOOR

Tracks



1/2" ADA Surface Track



3/4" Surface Track



2 3/16" Standard Surface Track



2 3/16" Standard Surface Track
(Wood Clad)



2 3/16" Thermally Broken
Standard Surface Track



3/4" Recessed Track



1 1/2" Recessed
Drainage Track



1 1/2" ADA Recessed
Drainage Track



2" Thermally Broken
Recessed Drainage Track



2 1/4" Recessed Drainage
Bottom Running Track



2 1/4" ADA Recessed Drainage

FOLDING DOOR

Handles

PC



Panda 100

PC



Panda 150

PC



Panda 200

PC



Panda 250

PC



Panda 300
ULTRA only

PC



Panda-V

PC



Panda-V (Lock)

●

●



Aria Throw

●

●

●



Leilani

●

●

●

●

●

●



Acacia

●

●

●

●

●

●



Summit

●

●

●

●

●

●



Aria

●



Smart Handle (Slim)

Pivot Doors

- Designed to be the focal point of your entryway
- Can reach 16' in height or 8' in width
- Available in: Aluminum, Steel, Aluminum-Wood Clad, and Solid Wood
- No threshold or ADA compliant surface threshold
- Thermally broken options



Why choose Panda's
pivot doors?

Grand Entrance

Choose a modern glass-only design or customize your pivot with custom patterns, creating striking entryways that leave a lasting impression.



Effortless Operation

Swing open exceptionally large doors with just the push of a finger using Panda's proprietary hardware, and enjoy the convenience of a self-closing door with a concealed closure.



Secure

Pivot doors feature a concealed multi-point locking system with up to five locking points, providing exceptional security and peace of mind.



Customization Options

PIVOT DOOR

Designs

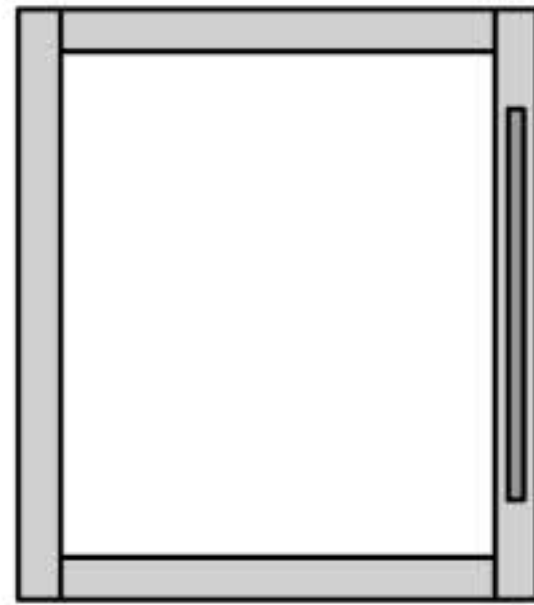

Everglade

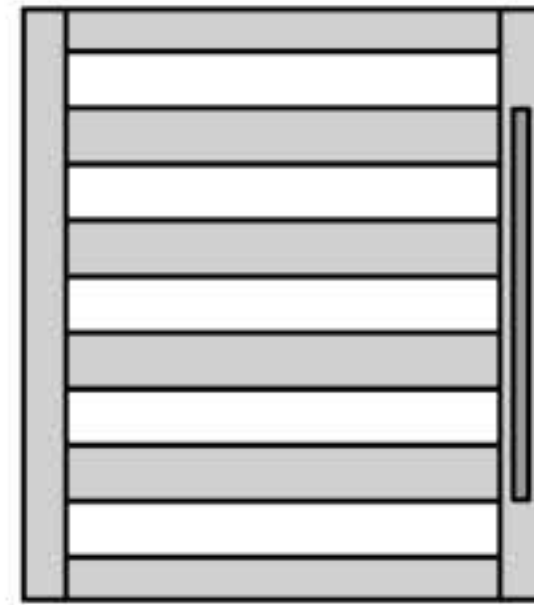

Yellowstone

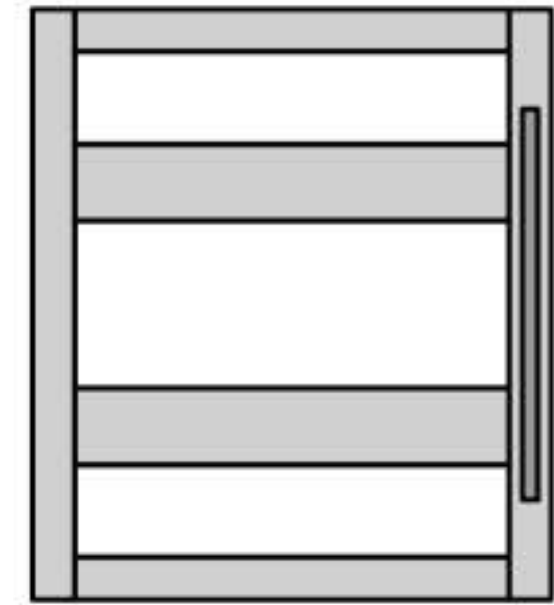

Everest

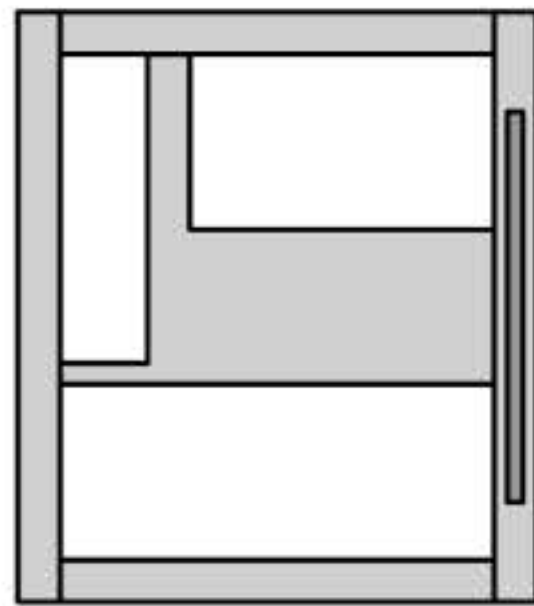

Joshua

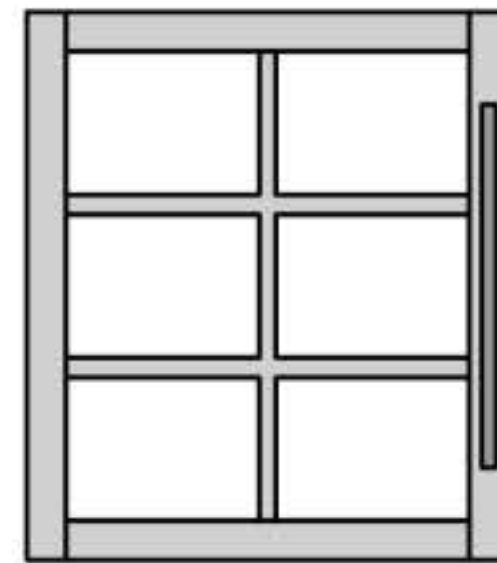

Denali

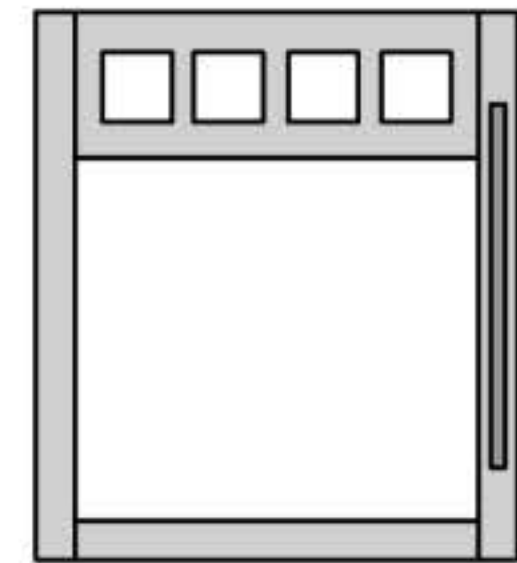

Rainier

PIVOT DOOR

Configurations

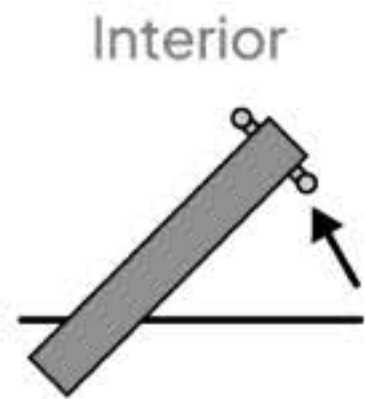

Left Handed Inswing

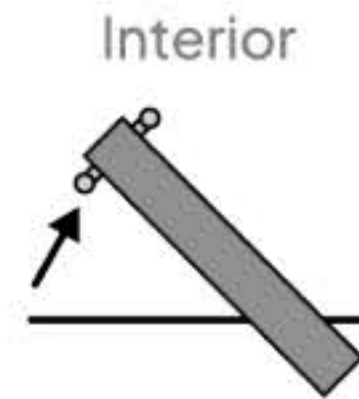

Right Handed Inswing

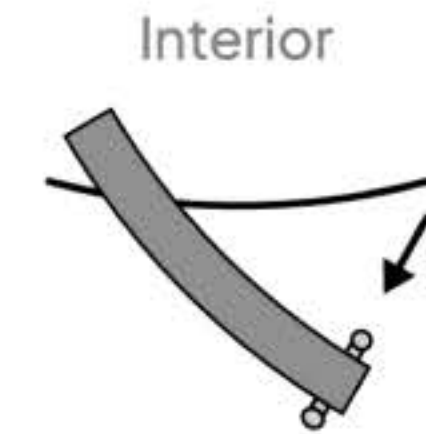

Left Handed Radius Outswing

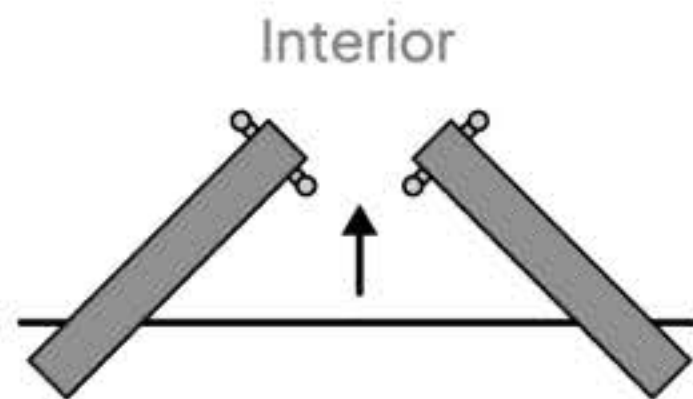

Double Inswing

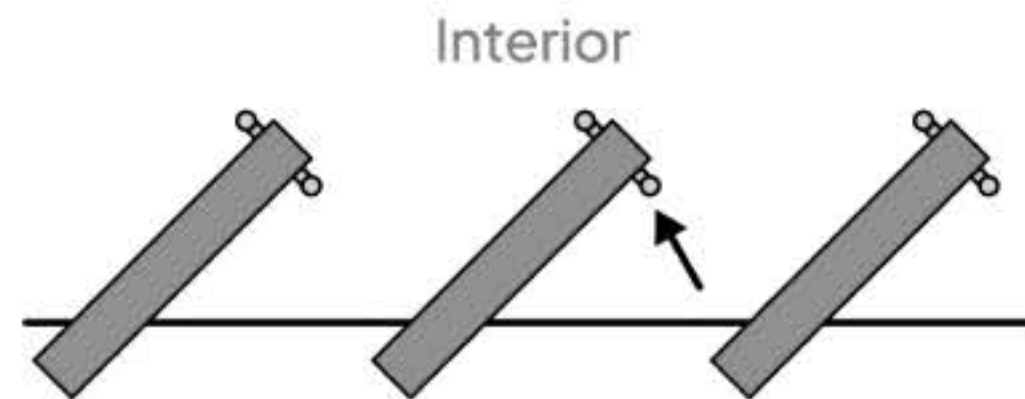

Pivot Wall

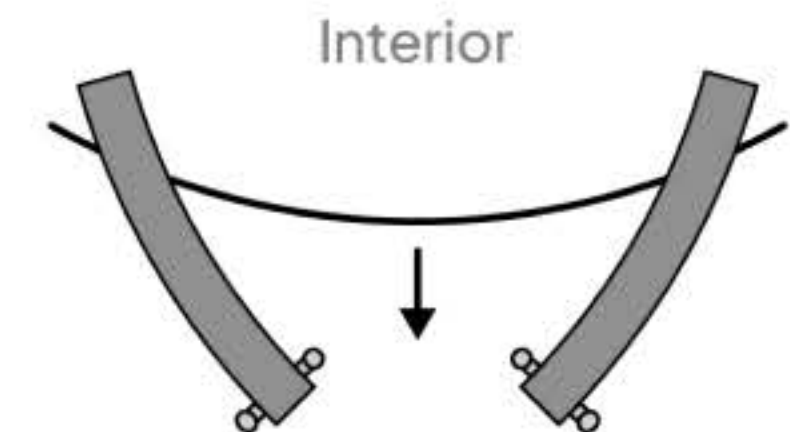

Double Radius Outswing

PIVOT DOOR

Thresholds

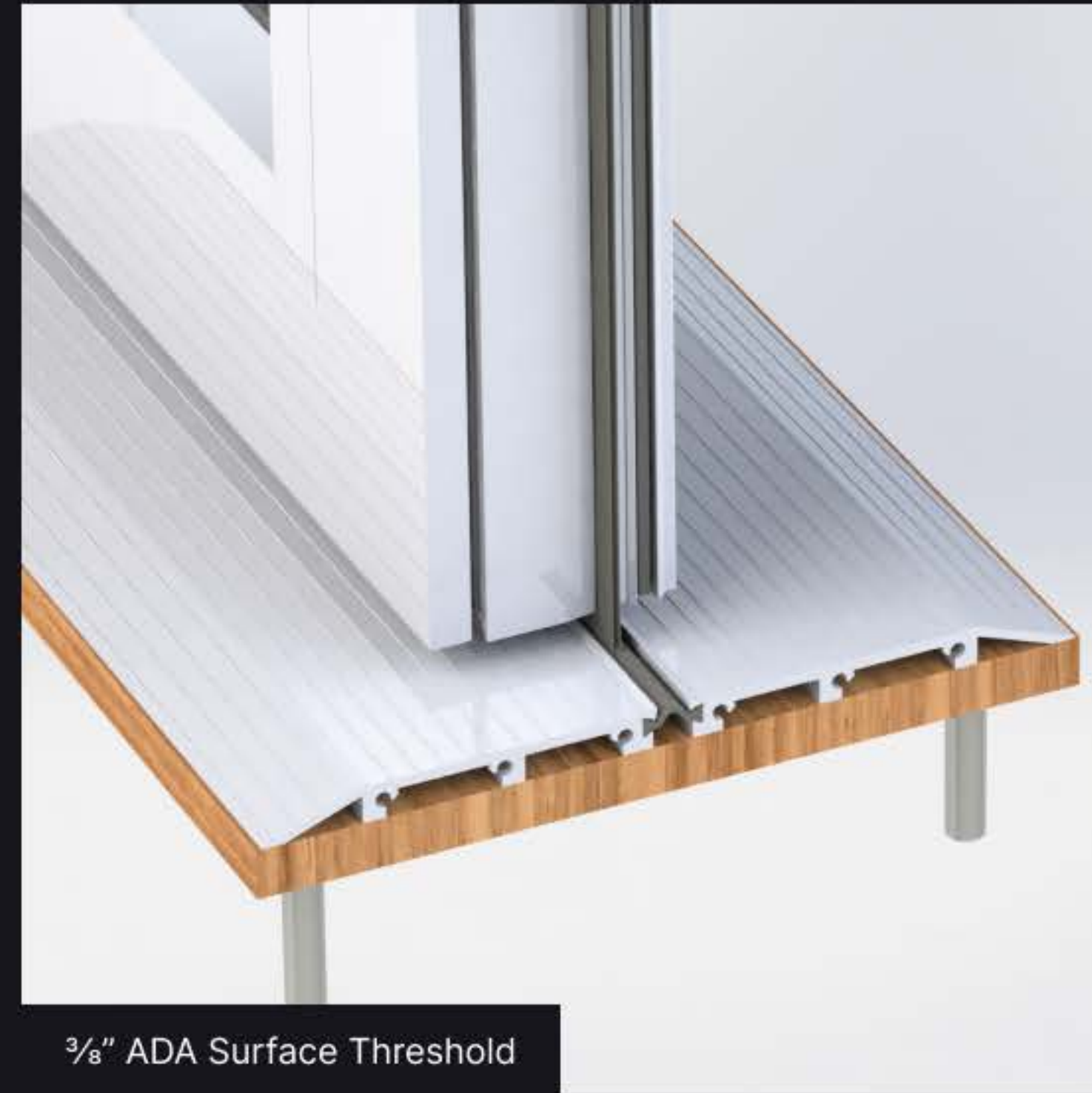

PIVOT DOOR

Handles

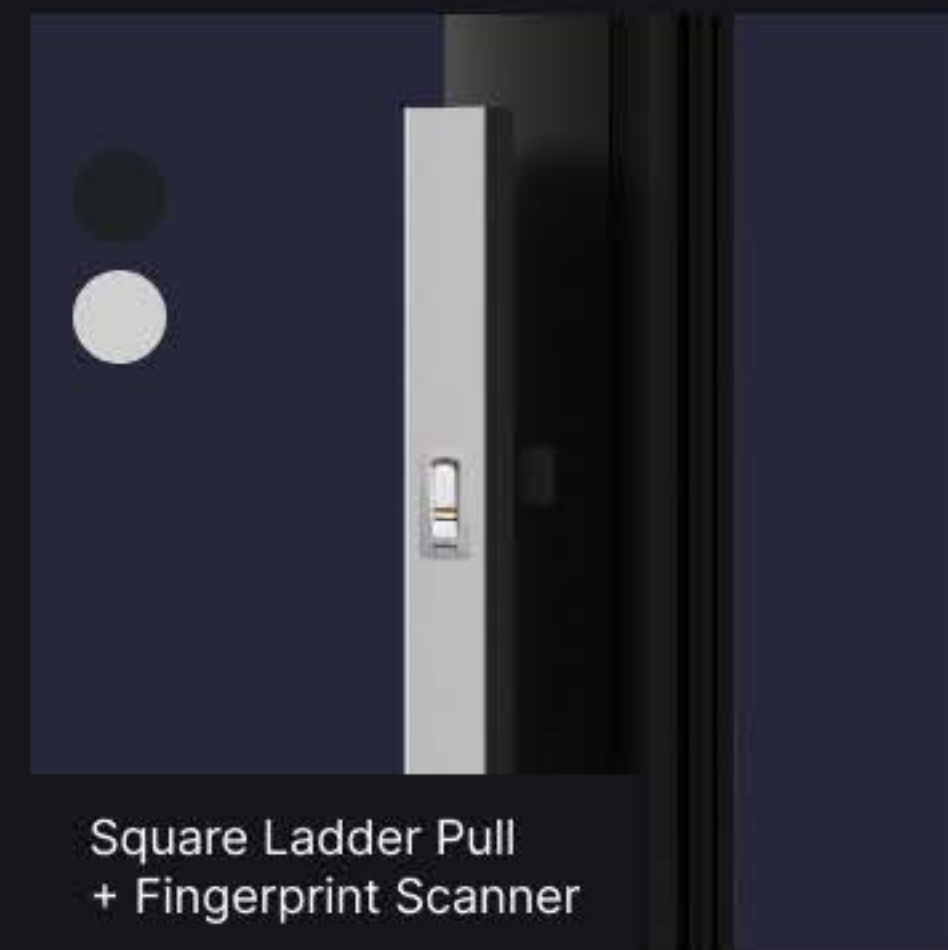
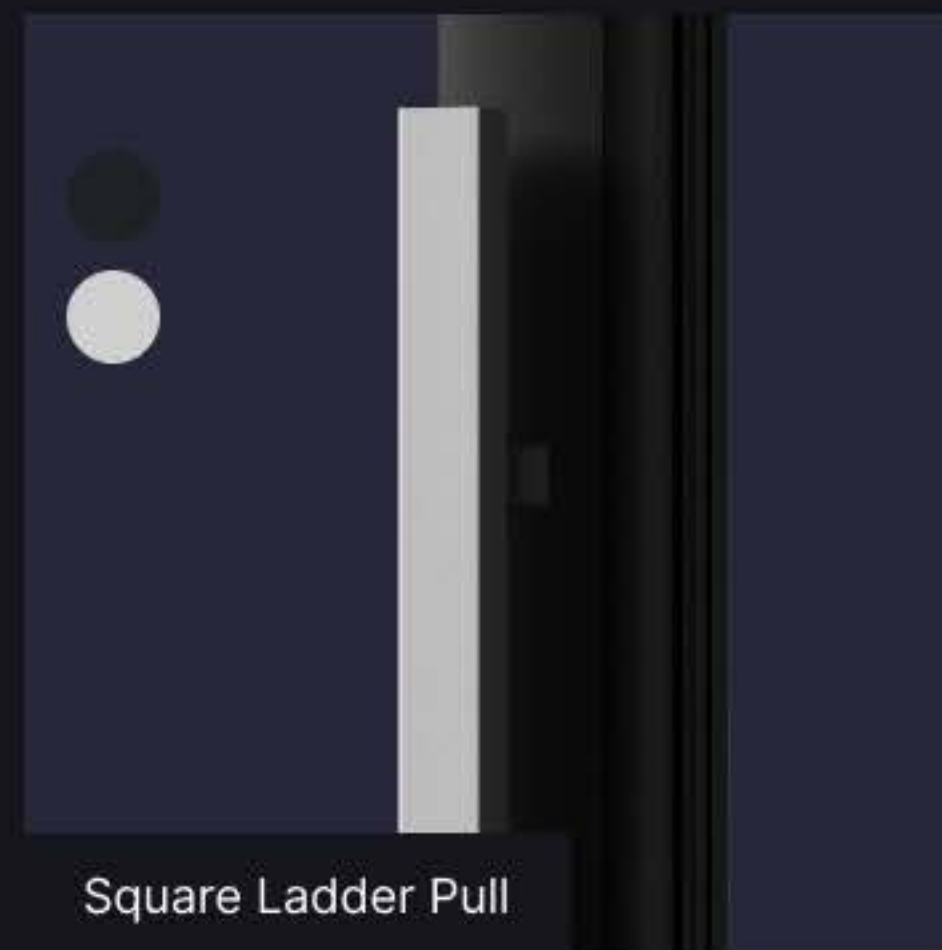
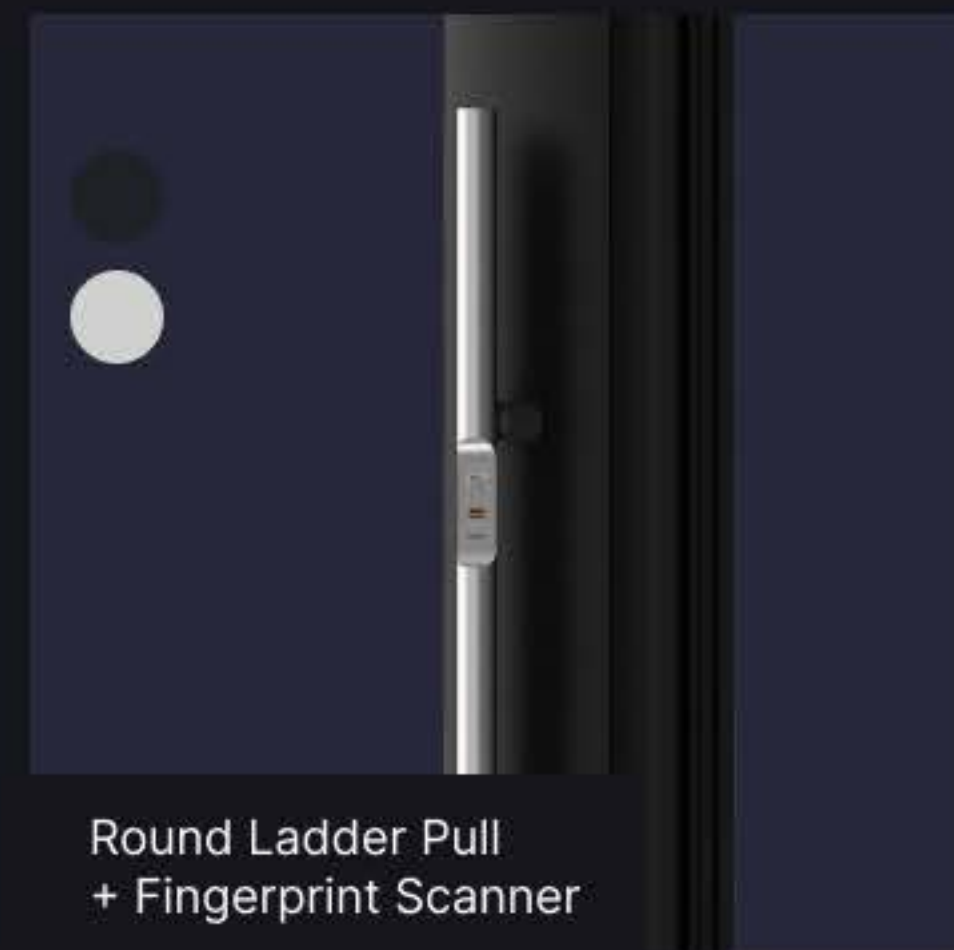
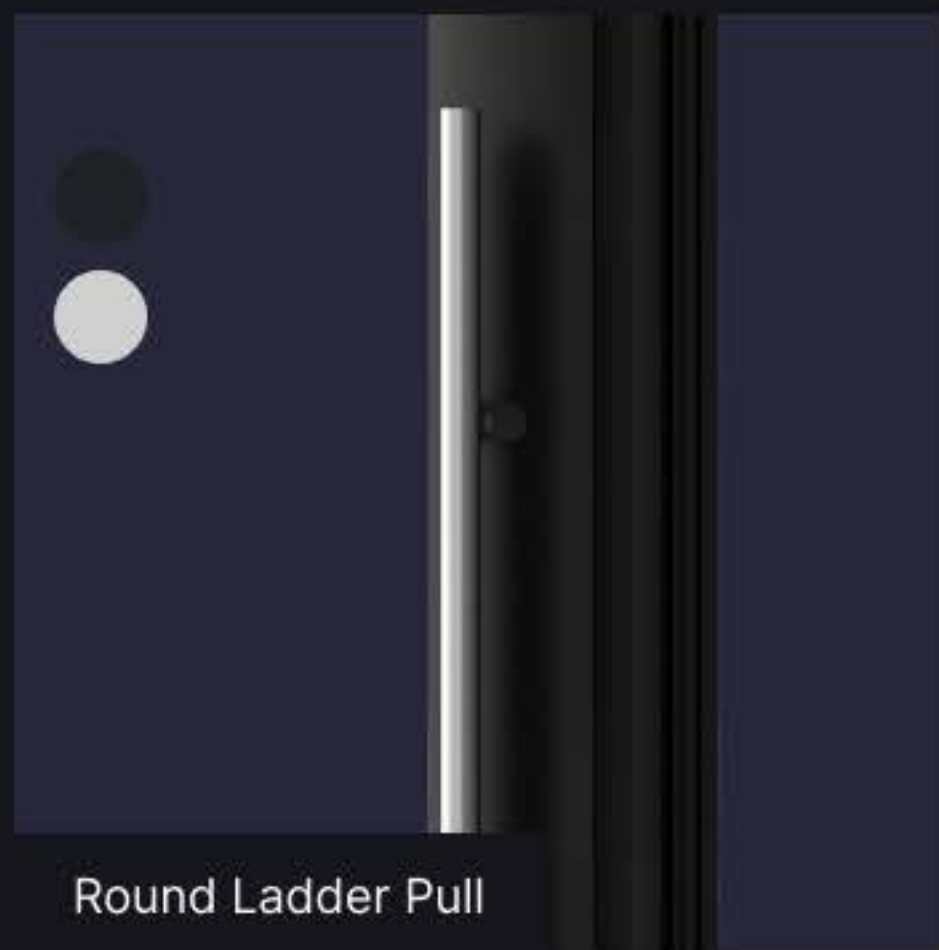
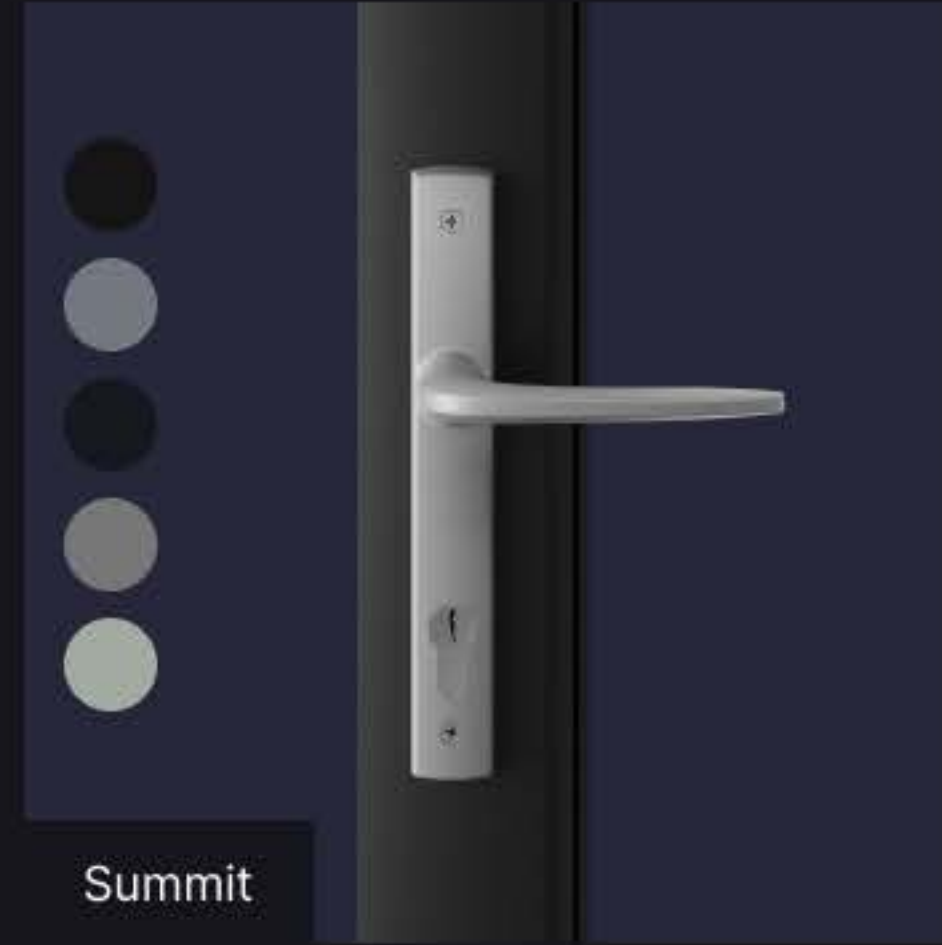

Multi-Slide

- The perfect choice for exceptionally wide spaces or views that can't be compromised
- Panels can reach 12' in height or 8' in width
- Available in Aluminum
- Surface, recessed, and drainage tracks available
- Thermally broken and impact rated options



Why choose Panda's
multi-slides?

Incredible Views

Can feature an unlimited number of panels and frame widths on a recessed track, so you can enjoy more views and natural light.



Performance

Available in a variety of thermal efficiencies, structural ratings, and impact resistance to meet the most stringent commercial building codes.



Range

Three different product lines: the budget-friendly PandaSelect line, the core product line, and the high-end X0 Slim-Line—premium quality for every budget.



Customization Options

MULTI-SLIDE

Configurations

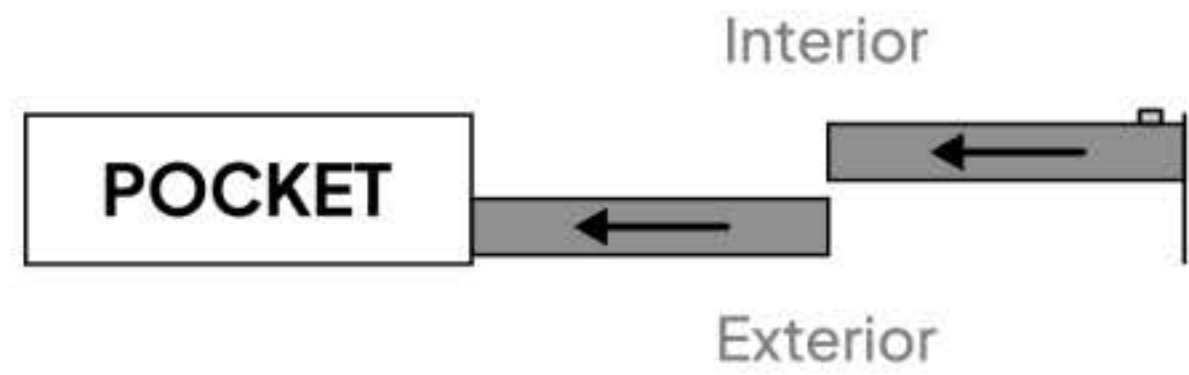

Pocket - 2 Active

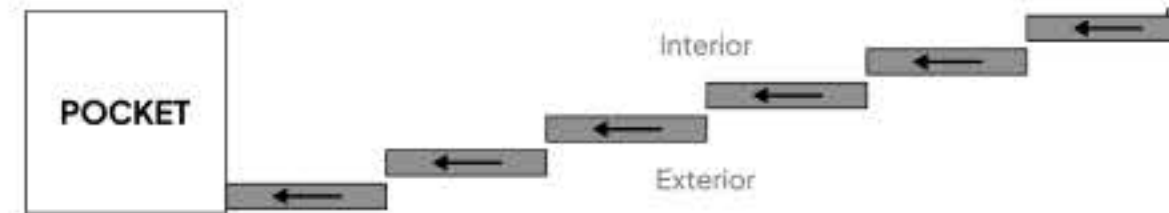

Pocket - 6 Active

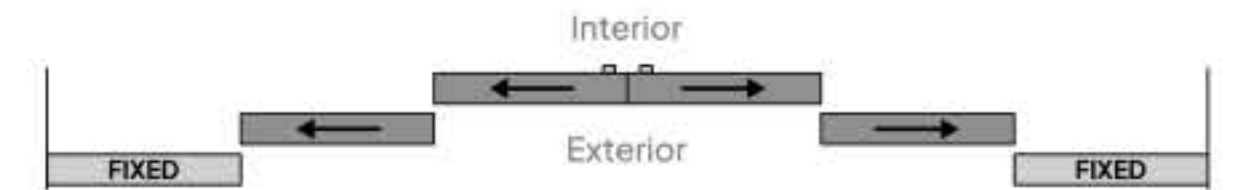

1 Fixed - 4 Active - 1 Fixed

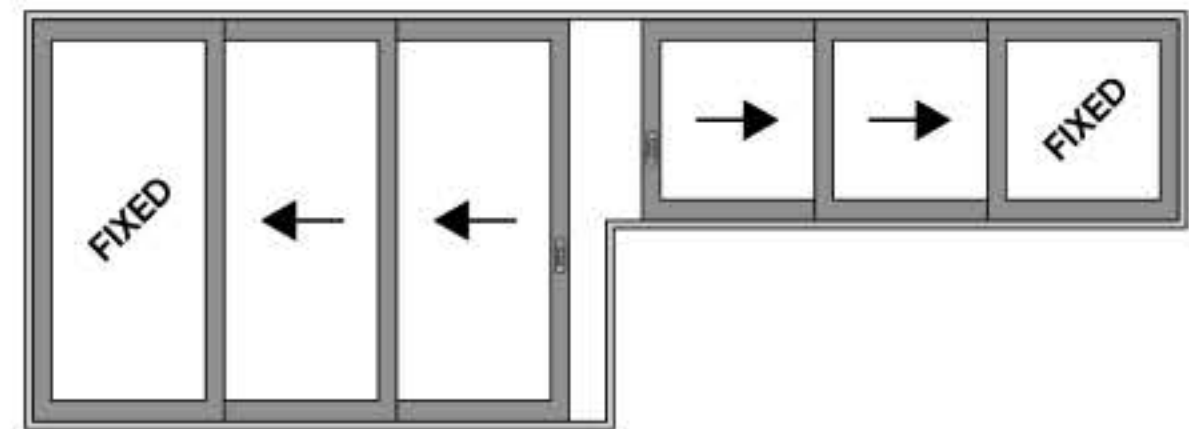

Exterior view.
Hardware shown for illustration only.

FlexCounter

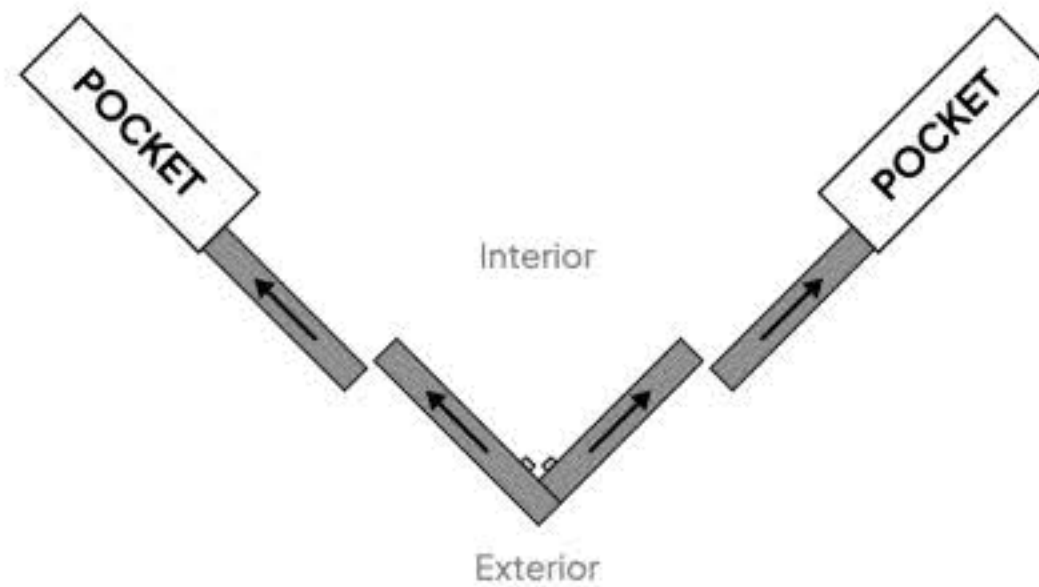

Zero-Post Corner

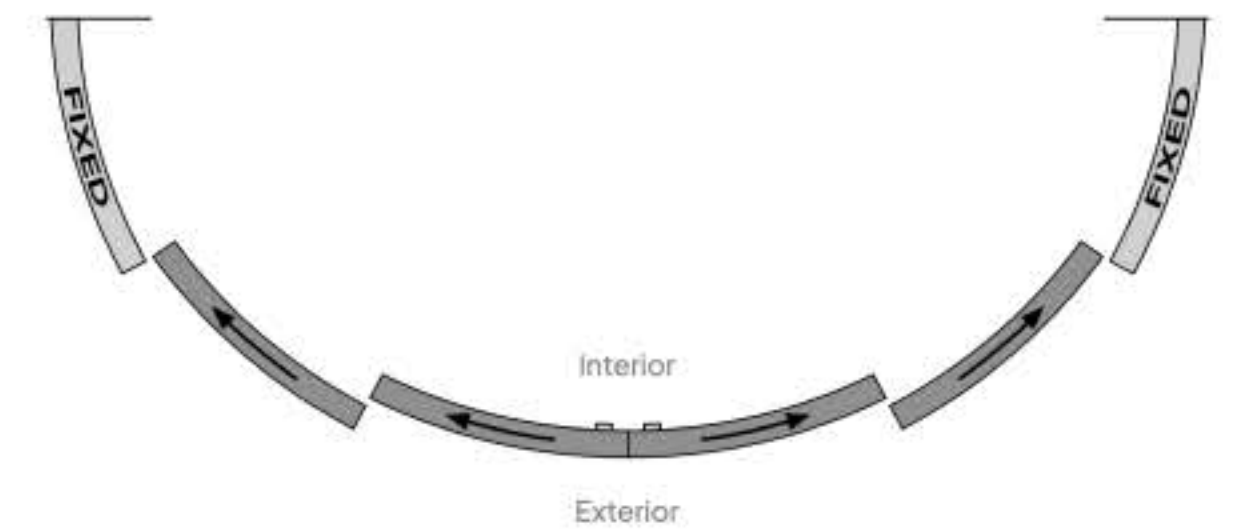

True Radius

MULTI-SLIDE

Tracks



9/16" Surface Track



5/8" Surface Track



1 1/4" Recessed Track



1 1/4" Recessed Drainage Track



2 1/2" Recessed Track



2 1/2" Recessed Drainage Track

MULTI-SLIDE

Handles

PC



Cremone



Tower



Recessed

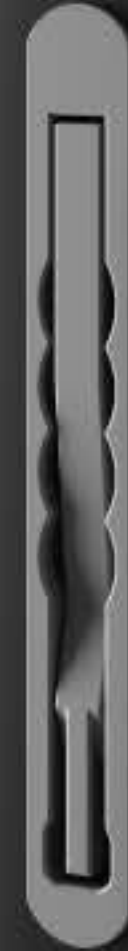

Flush



Smart Handle

Lift & Slide

- For best-in-class weather resistance, security, and incredible views
- Panels can reach 24' in height or 16' in width
- Available in: Aluminum, Steel, Aluminum-Wood Clad, and Solid Wood
- Surface, recessed, and drainage tracks available
- Thermally broken, impact rated, and ADA compliant options



**Why choose Panda's
lift and slides?**

Expansive Views

Can feature an unlimited number of panels and frame widths on a recessed track, so you can enjoy more views and natural light.



Effortless Operation

Non-corrosive rolling hardware ensures silky smooth operation with just the push of a finger, even with exceptionally heavy panels.



Peak Performance

Industry-leading structural ratings and
impact resistance to meet the most
stringent commercial building codes.

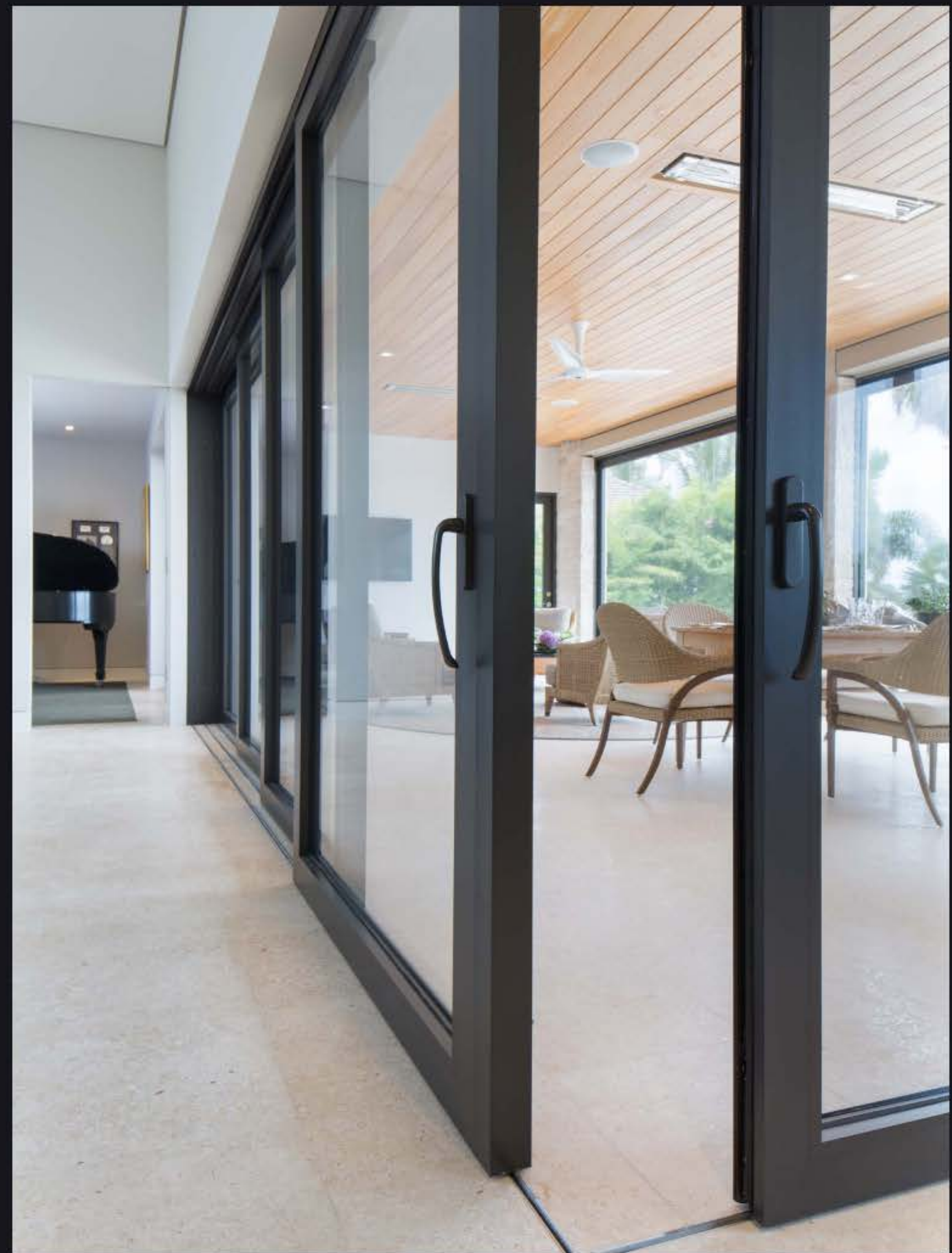

Customization Options

LIFT & SLIDE

Configurations

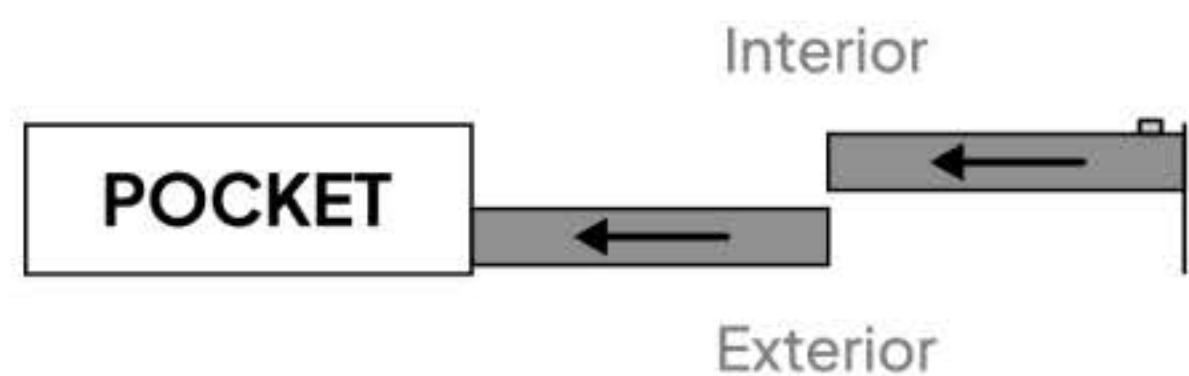

Pocket - 2 Active

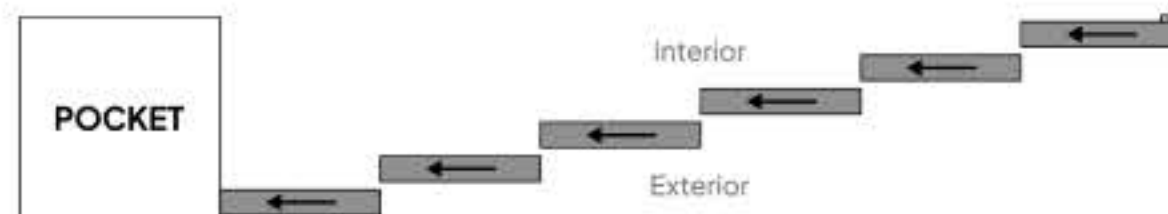

Pocket - 6 Active

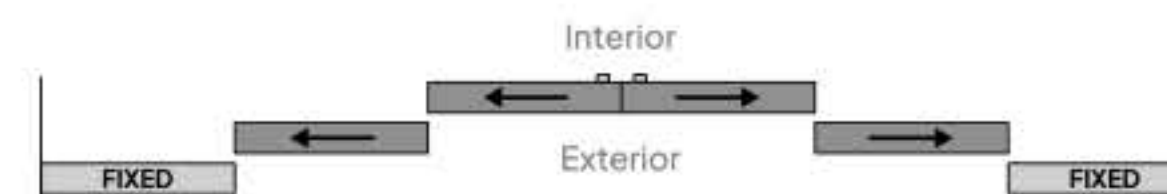

1 Fixed - 4 Active - 1 Fixed

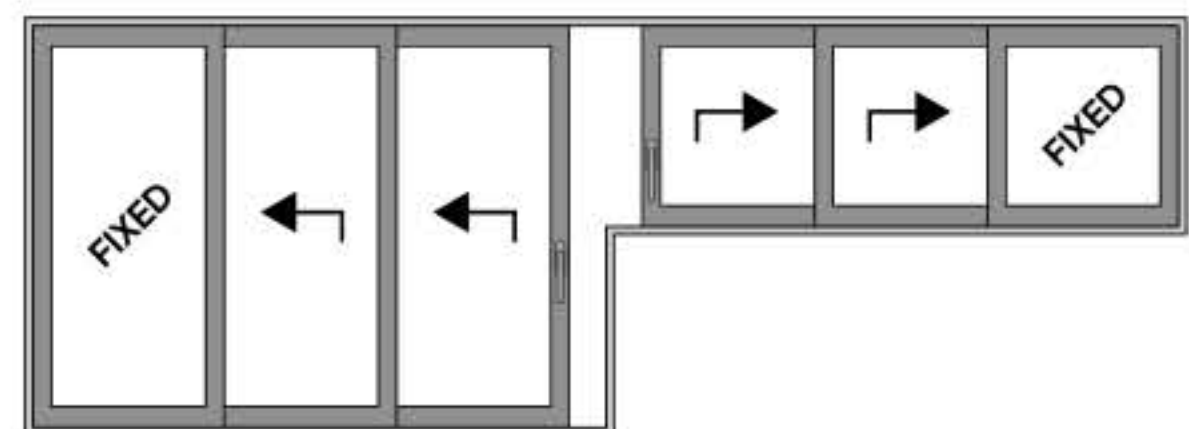

Exterior view.
Hardware shown for illustration only.

FlexCounter

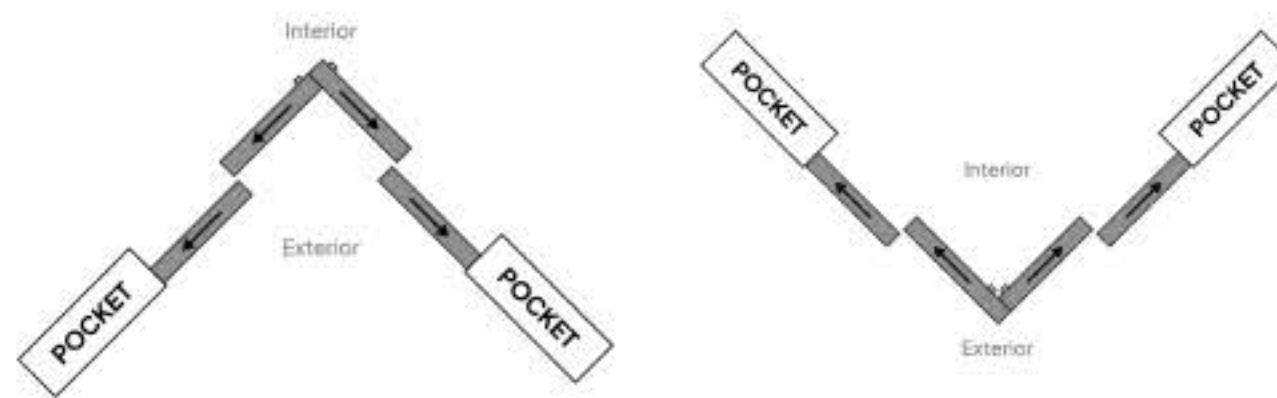

Inverted

Standard

Zero-Post Corners

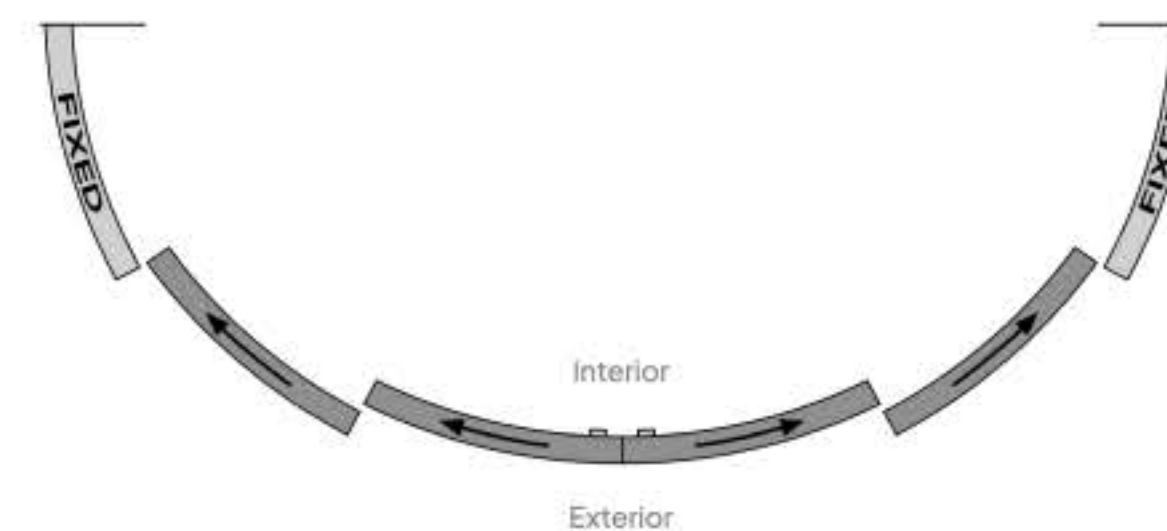

Radius

LIFT & SLIDE

Tracks



5/16" Surface Track



1/2" Surface Track with Sill Pan



1 1/4" Recessed Track



1 1/4" Recessed Drainage Track



2 1/2" Recessed Track



2 1/2" Recessed Drainage Track



2 1/2" Recessed Drainage Track with Retention Track

LIFT & SLIDE

Handles

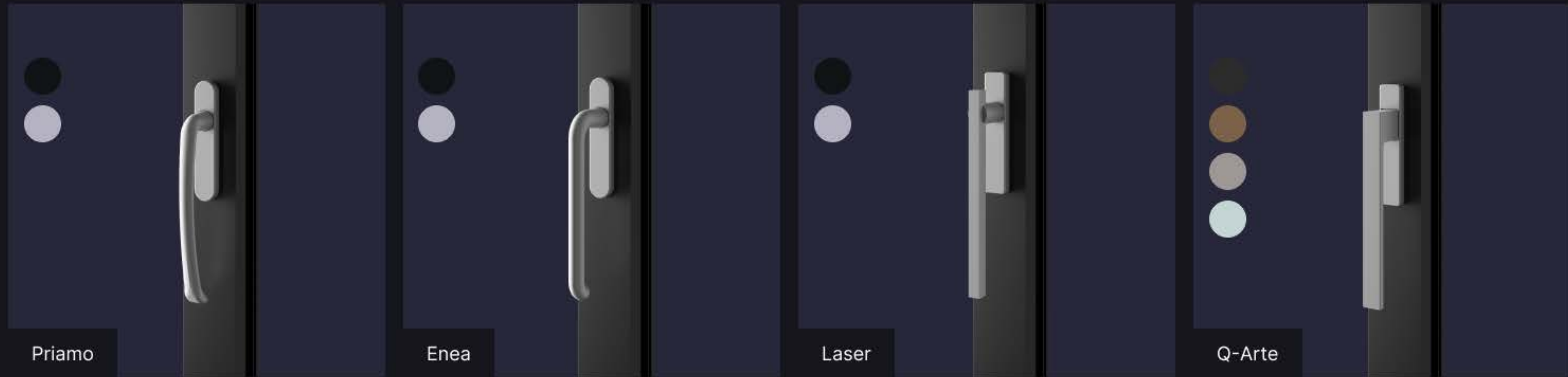

Priamo

Enea

Laser

Q-Arte



Recessed

Hoppe Folding

Temporary

Hinged Doors

- A mainstay feature of commercial and residential builds, now with slender profiles
- Doors can reach 14' in height and 42" in width
- Available in: Aluminum, Steel, Stainless Steel, Architectural Bronze, Aluminum-Wood Clad, and Solid Wood
- No threshold or ADA compliant surface threshold
- Thermally broken options



Why choose Panda's
hinged doors?

Matching Profiles

Hinged doors profiles perfectly match our folding, lift & slide, and multi-slide systems, offering a seamless and harmonious design.



Grand Entryways

Door panels can reach up to 14 feet in height, offering the freedom and grandeur of expansive entryways.



Maximum Security

Feature a concealed multi-point locking system with up to five locking points, providing exceptional security and peace of mind.



Customization Options

HINGED DOOR

Configurations

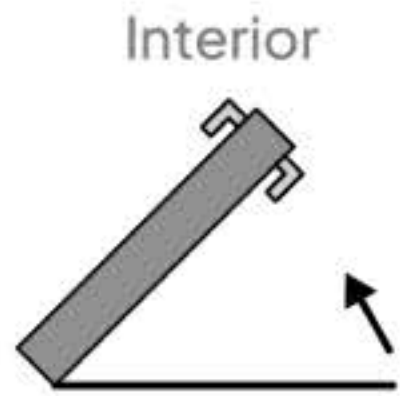

Left Handed Inswing

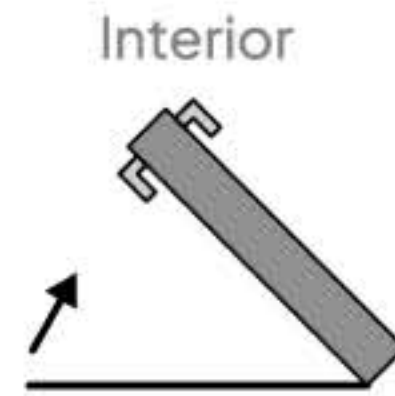

Right Handed Inswing

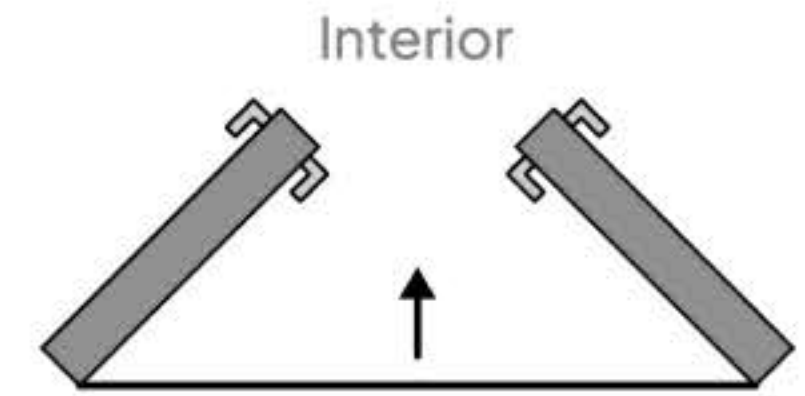

Double Inswing

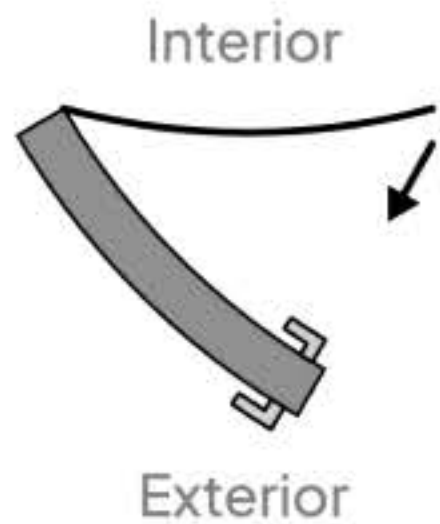

Left Handed Radius Outswing

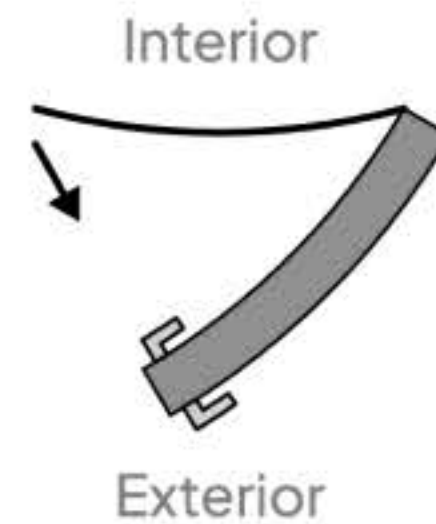

Right Handed Radius Outswing

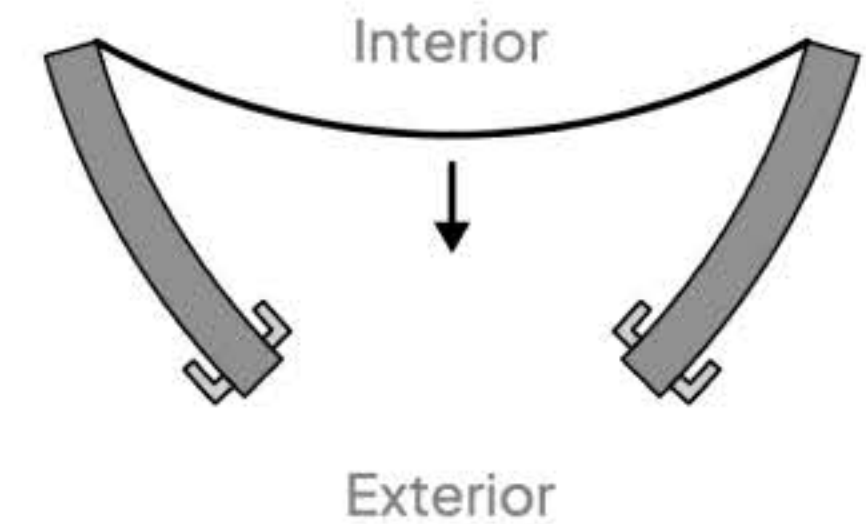

Double Radius Outswing

HINGED DOOR

Thresholds



HINGED DOOR

Handles



Horizontal Sliding Walls

- Panels can seamlessly navigate around corners, curves, and intricate layouts
- Panels can reach 12' in height and 50" in width
- Available in: Frameless, Aluminum, Aluminum-Wood Clad, and Solid Wood
- No threshold, surface, recessed, and drainage tracks available
- Thermally broken options



**Why choose Panda's
horizontal sliding walls?**

Framed or Frameless

Enjoy uninterrupted views with a sleek, all-glass frameless design, or choose a more traditional look with aluminum, aluminum-wood clad, or solid wood frames.



Hidden Panels

Panels can easily navigate around curves and corners, stacking discreetly behind walls or within pockets, completely out of sight.

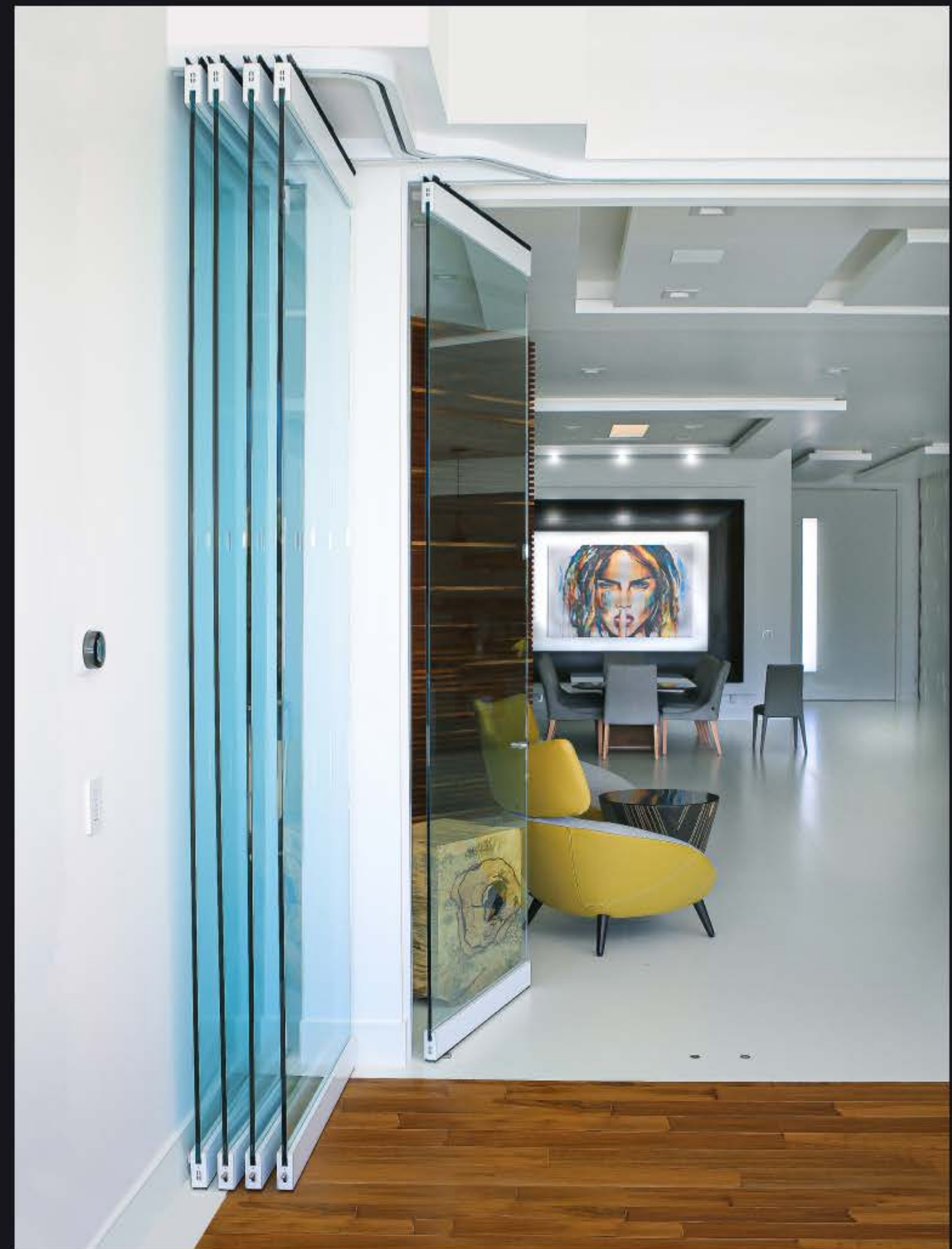

Threshold

For a sleek and seamless design, opt for a no-sill threshold. For added protection, choose between surface or recessed sills, available with or without drainage options.



Customization Options

HORIZONTAL SLIDING WALLS

Configurations



Offset Parking



Parallel Parking with Swing Door



Perpendicular Parking

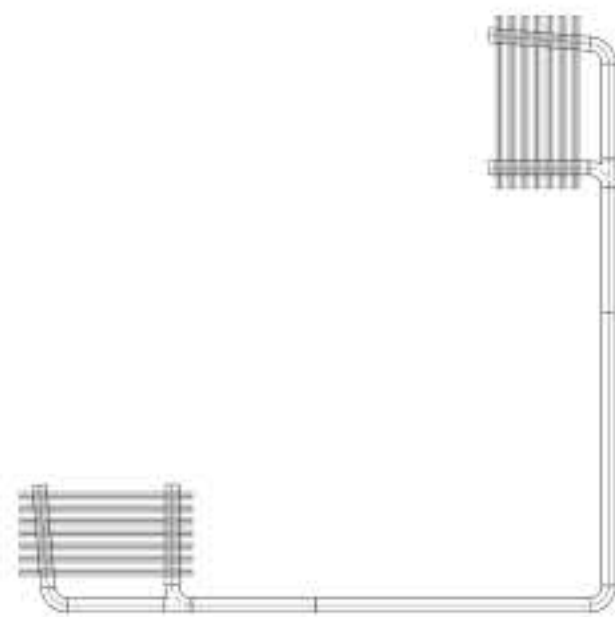

90 Degree Corner

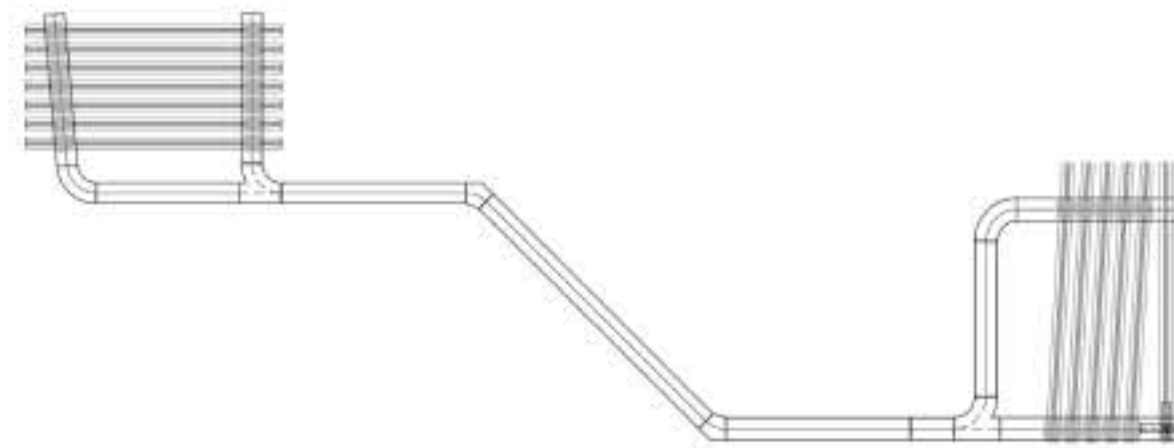

Zig-Zag

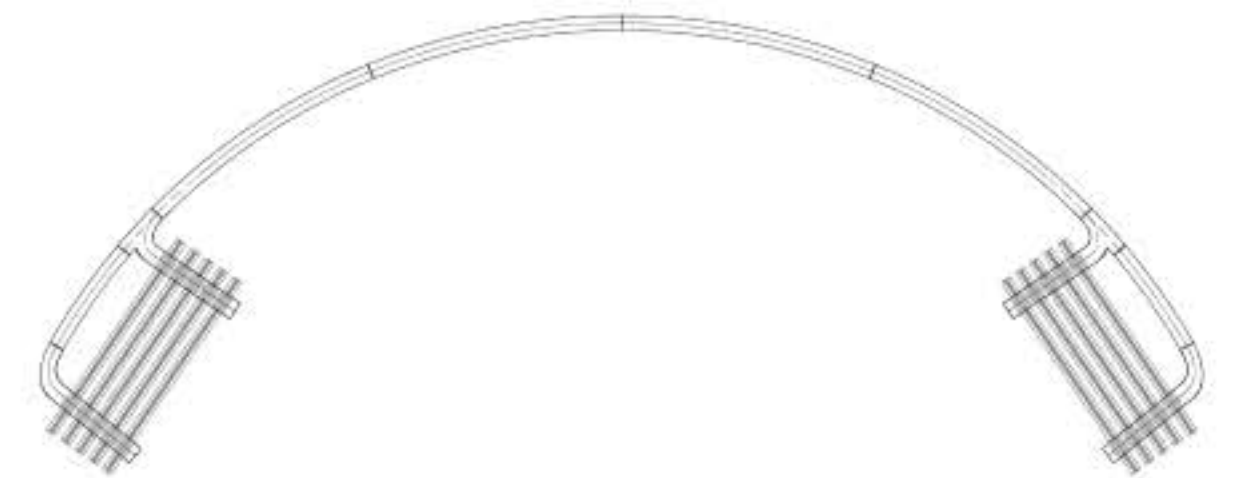

Segmented Radius

HORIZONTAL SLIDING WALLS

Thresholds



1/2" ADA Surface Track



3/4" Surface Track



3/4" Recessed Track



1 1/2" Recessed Drainage Track



1 1/2" ADA Recessed Drainage Track



2" Thermally Broken Recessed Drainage



Dust Proof Keepers

HORIZONTAL SLIDING WALLS

Handles

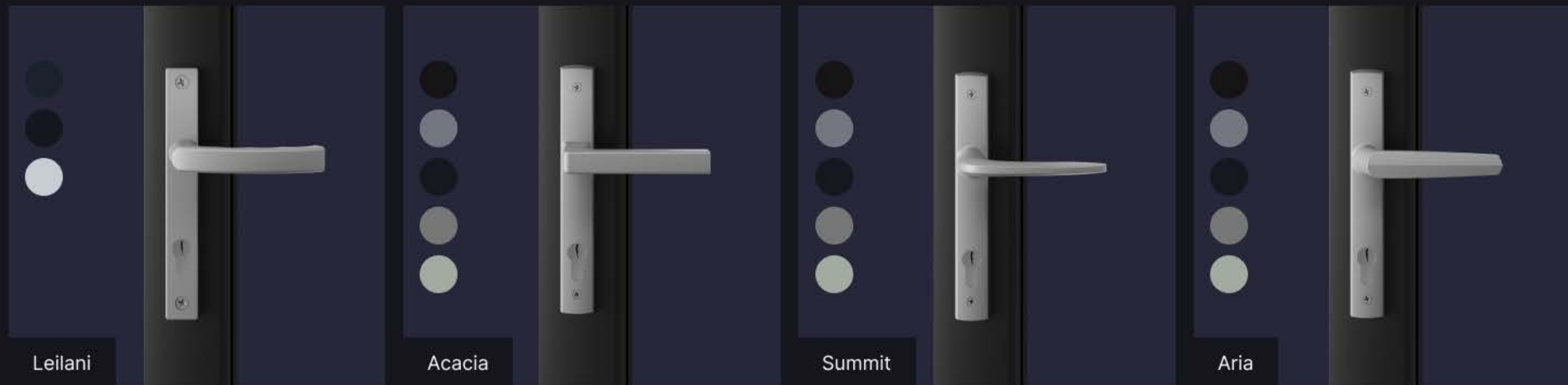

Windows

- Styles - awning, casement, fixed, folding, hopper, sliding, and tilt-and-turn
- Casement and tilt-and-turn windows can reach 8' in height or 40" in width
- Awning and hopper windows can reach 8' in height or 120" in width
- Available in: Aluminum, Steel, Stainless Steel, Architectural Bronze, Aluminum-Wood Clad, and Solid Wood
- Thermally broken and impact rated options



**Why choose Panda's
windows?**

Matching Profiles

Fixed and operable windows feature profiles designed to seamlessly match with our door systems, creating a harmonious and cohesive look



Sweeping Views

Enjoy breathtaking views and refreshing natural airflow with large windows that can span virtually any frame width.



Performance Glass

Windows come standard with dual-glazed, tempered glass featuring a Low-E coating, and can be customized to meet any energy code, STC, or impact requirement.



Customization Options

WINDOWS

Handles



Screens

- Any system can be equipped with a screen
- Available as pleated retractable, roll-up, sliding, or fixed
- Retractable screens can reach 10' in height and 32' in width
- Sliding screens can accommodate virtually any frame width



Why choose Panda's
screens?

Refreshing Breeze

Protect your interior from damaging sun rays, reduce energy bills, and enjoy refreshing breezes with a seamless indoor-outdoor experience year-round.



Frame Size

Pleated retractable screens can stand up to 10' tall and span up to 16' wide as a single screen, or up to 32' wide as a bi-part double screen.

Wider Frames

For frames wider than 32', sliding screens can accommodate an unlimited number of panels, enabling virtually any frame width.



Application

Screens can be mounted inside or out, giving you the flexibility to achieve your goals of design and functionality, without compromise.



GLASS

Premium Glass

All systems come standard with dual-glazed, tempered glass featuring a Low-E coating.

Glass can be selected to meet specific energy efficiency, STC rating, security, impact resistance, or aesthetic needs



GLASS

Options

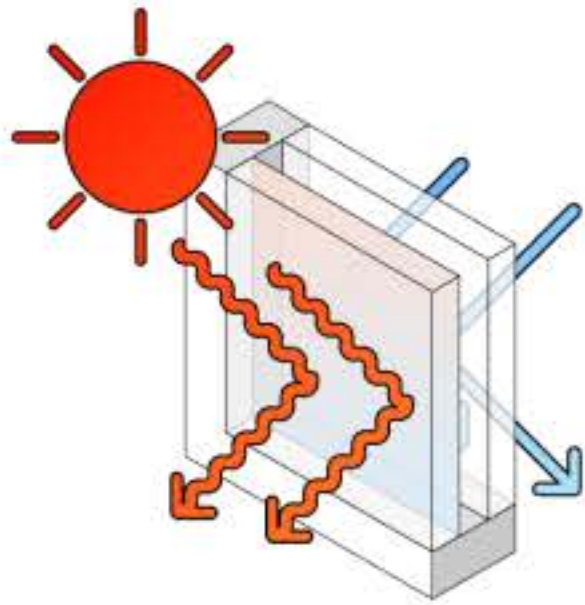

Low-E Coating

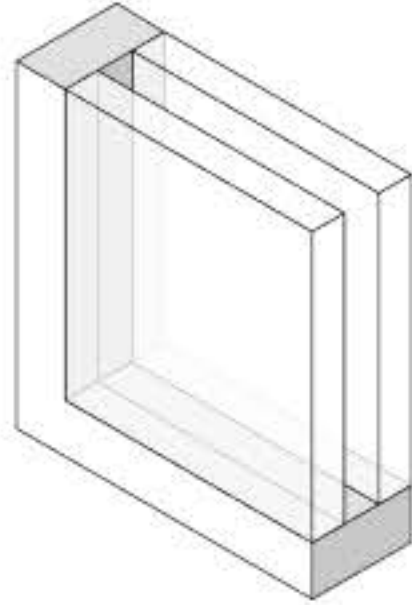

Double Pane

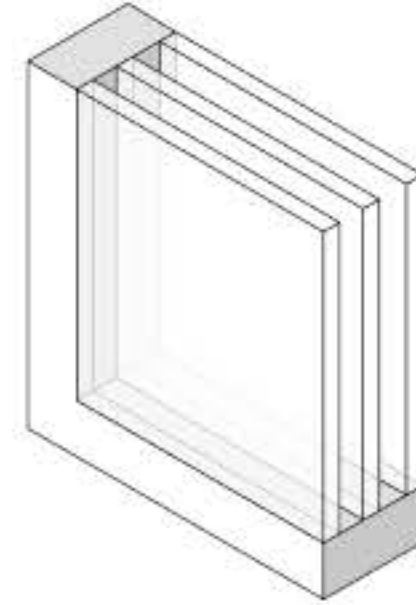

Triple Pane

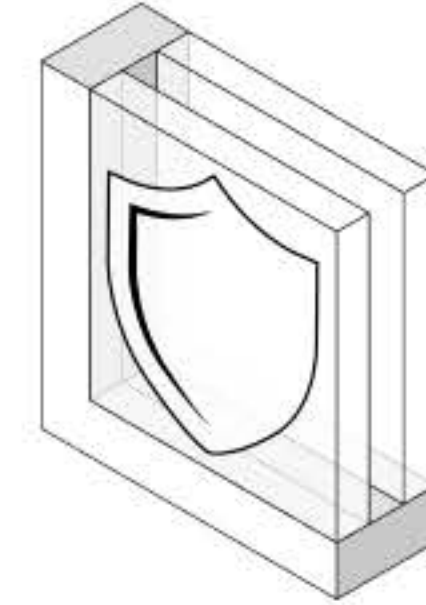

Tempered

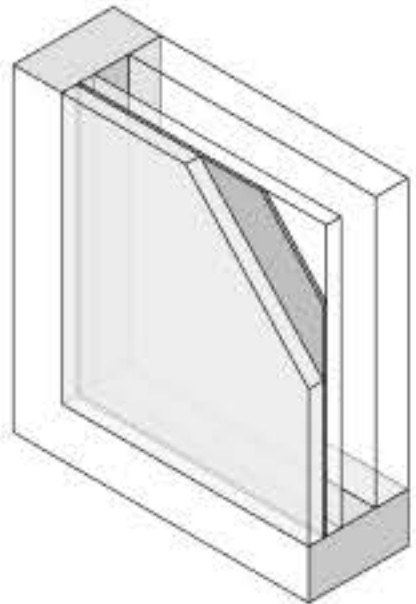

Laminated

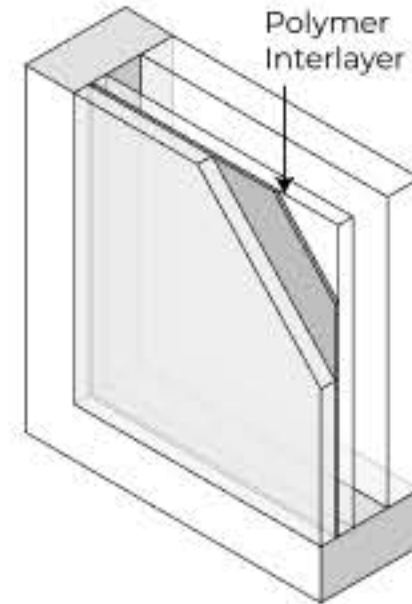

Impact-Resistant

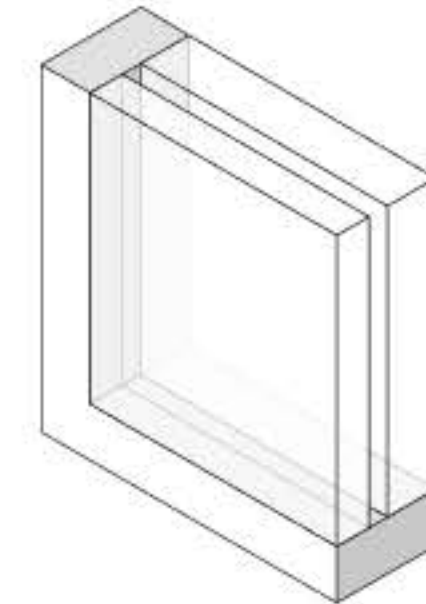

STC Double Pane

GLASS

Simulated Divided Lites

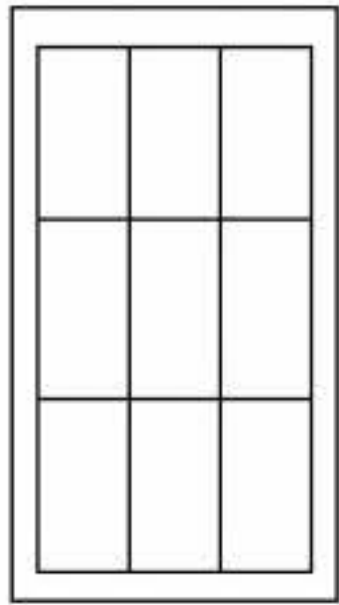

Colonial

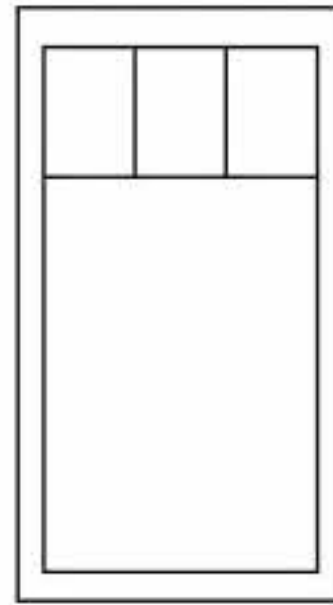

Cottage

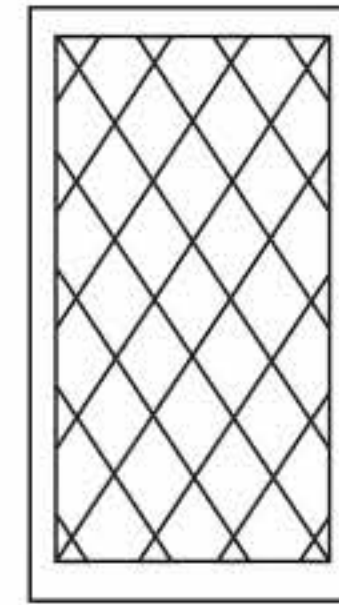

Diamond

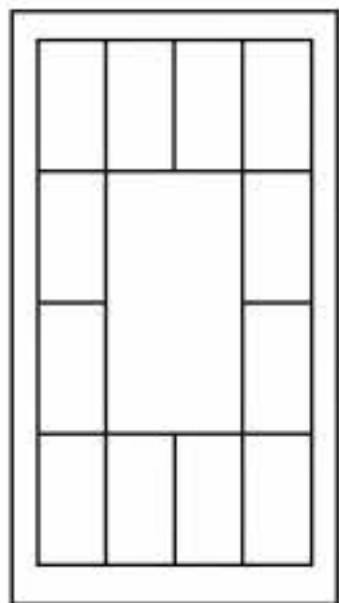

Victorian

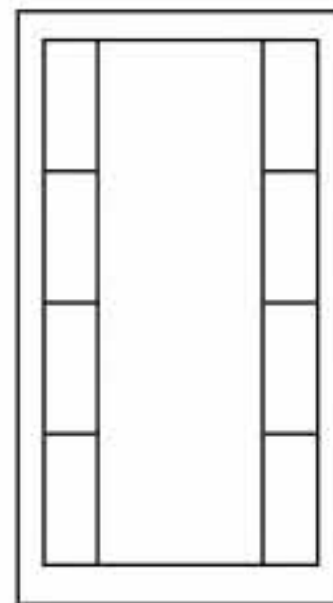

Trellis Vertical

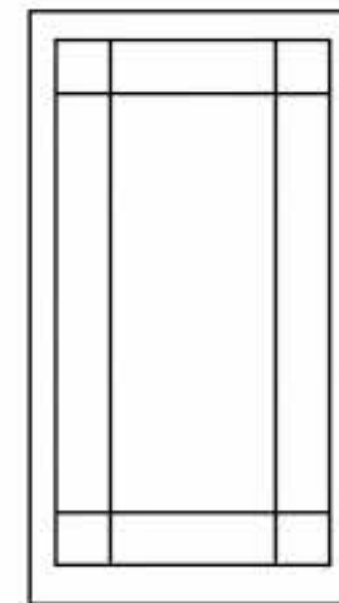

Prairie 9

EMERGING PRODUCTS

PandaTEK Cladding

The simple and affordable way to transform any surface into a sleek and modern facade.

- Effortless installation without the need for surface prep
- Elevate any space with striking accent walls or stunning facades, inside or out
- Improve energy efficiency with an additional thermal barrier



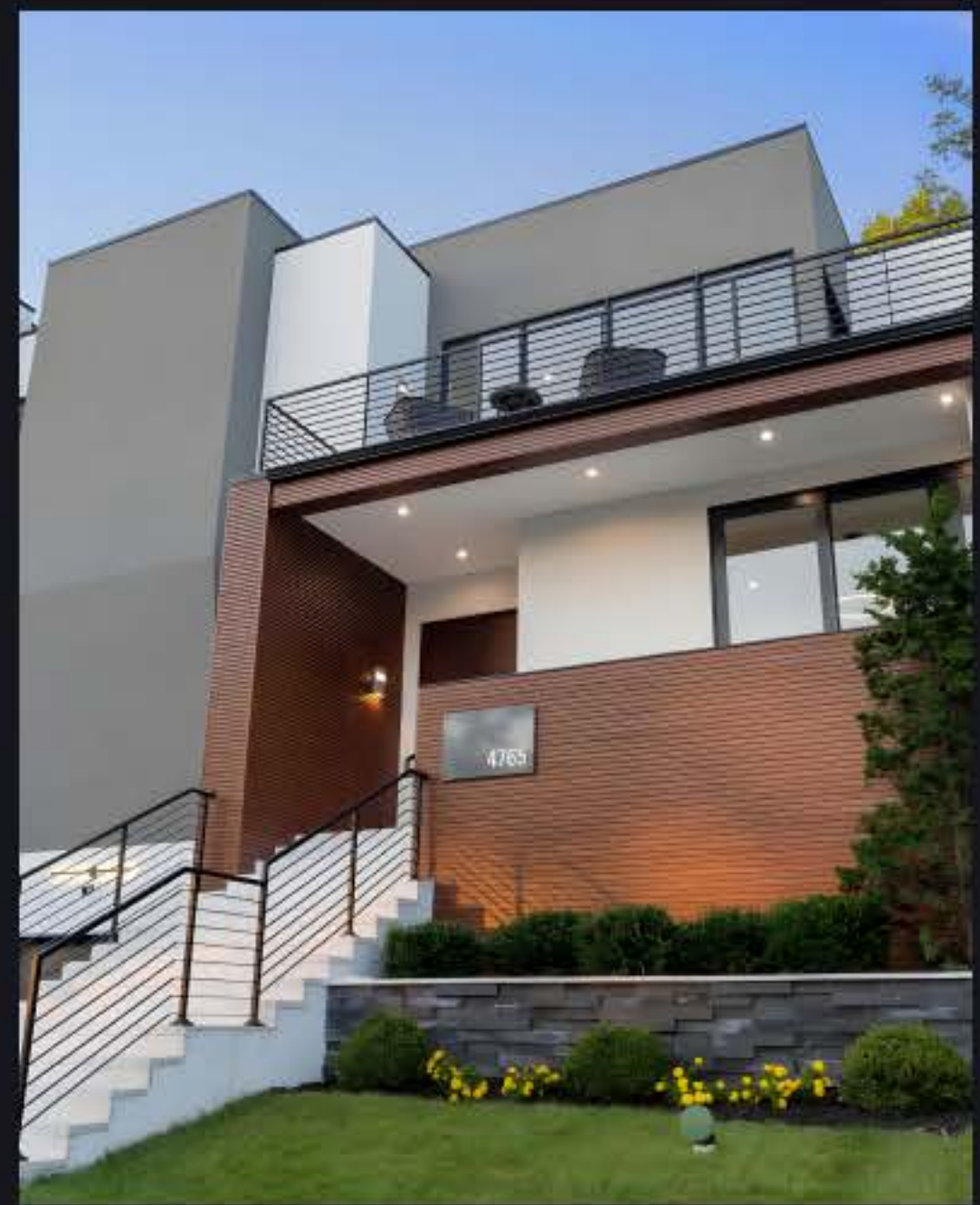

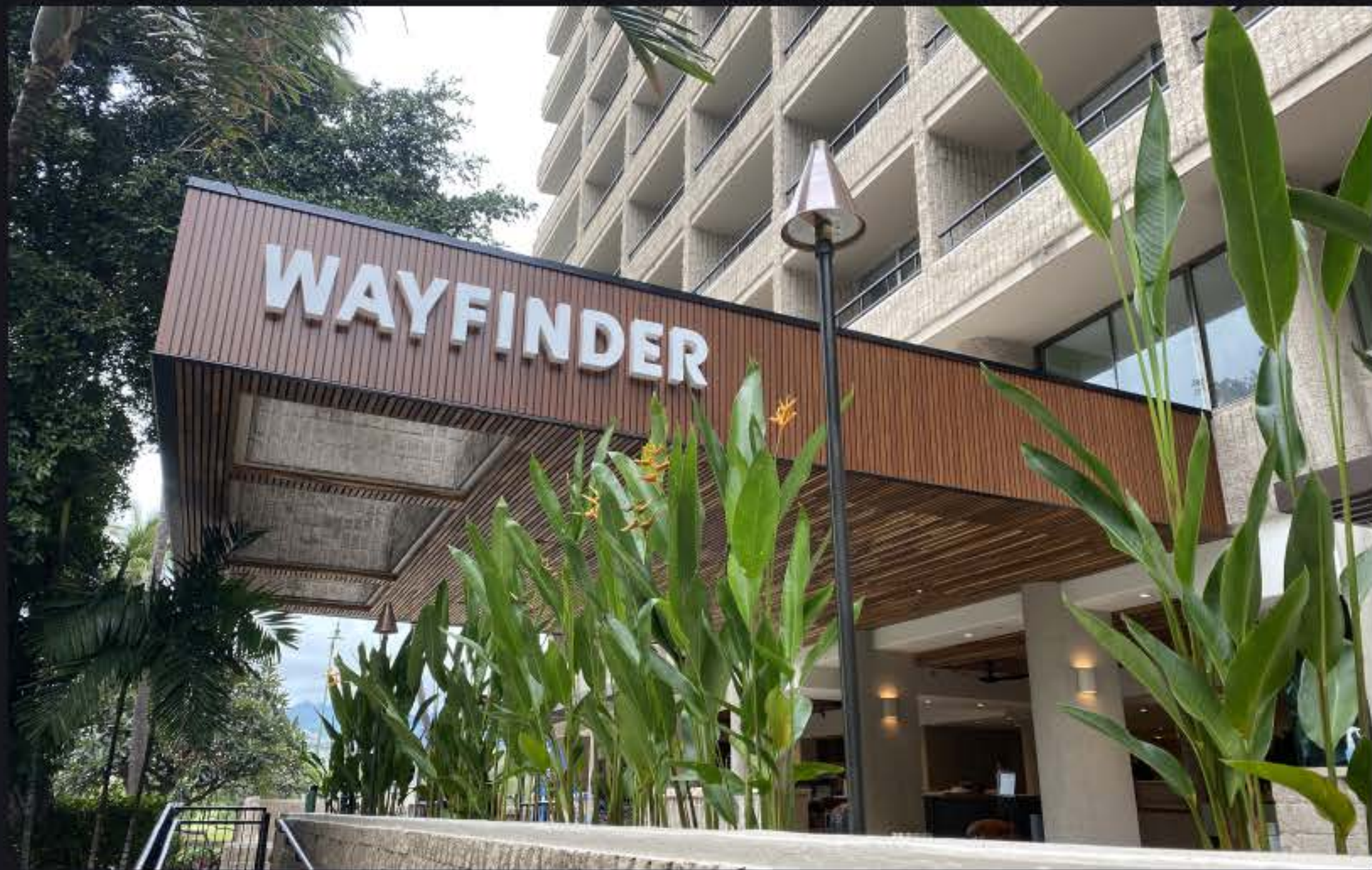

PandaSHADE

A premium louver system that provides the perfect harmony of airflow, natural light, and privacy while your windows and doors are open.

- Adjustable slats allow effortless control over natural light and airflow
- Fully automated, controlled using wall switches and remotes
- Improve energy efficiency and protect your interior from damaging sun exposure



PANDASHADE

Guide Rails



Embedded



Partially Embedded



Non-Embedded

PANDASHADE

Mounting Options



Under Mount



Pocket Mount



External Mount

WARRANTY

Powder Coat Finish	20 Years
Kynar Paint Finish	10 Years
Anodized Finish	10 Years
Hardware Coverage	10 Years
Glass Coverage (per manufacturer)	10 Years
Transferability	10 Years
Warranty Start Date	Fabrication Date

Some restrictions apply:

- Systems located outside the United States have a 2-year warranty.
- Systems made of steel, stainless steel, or architectural bronze have a 10-year warranty.
- Systems located within 1 mile of an ocean have a 1-year warranty on all Finish and Hardware.
- Labor is not covered under this warranty.

Quality

Precision engineering and the finest craftsmanship

Materials

Aluminum, Steel, Stainless Steel, Architectural Bronze, and Wood

Customization

Unlimited features and options to meet your every need



Doors



Windows



Shades



Premium Materials

Custom Made

Award-Winning

Lead Time: 8-10 Weeks



Dazzling Dimensions

Refined Engineering



For quotes and inquiries contact us at:

info@panda-windows.com

QUESTIONS?