



H-STRUT[®] Metal Framing System

Available in a series of sizes and welded combinations to meet all structural requirements, the H-Strut Metal Framing System provides a firm anchorage to the building structure or any other type of support applications including walls, ceilings and floors. The H-Strut Metal Framing System can also be custom cut to meet the job's specific needs to ensure the system is strong and fit for the application.

Manufacturing Processes

H-Strut channels are roll-formed into shape in various available sizes and profiles.

- Robust welding capacity across the United States
- Custom lengths available for job requirements
- Raw material and in-line quality checks
- Standard length tolerance $\pm 1/8$ "

Compliance & Certifications

- Manufactured from high-quality, domestically sourced steel and compliant with:
 - Buy American Act
 - Build America, Buy America Act
 - American Reinvestment Recovery Act (ARRA)
 - American Iron & Steel (AIS)
- LEED Certifiable
- UL Listed Electrical Products

Materials

H-Strut channels are produced from prime structural metals covered by the following specifications.

- Pre-Galvanized Steel (ASTM A653 SS Grade 33, G90)
- Plain Steel (ASTM A1011 SS Grade 33)
- Stainless Steel - Type 304 or 316/316L (ASTM A240)
- Aluminum - Type 6063-T6 (ASTM B221)

Finishes

H-Strut is available in the following finishes. Other finishes may be available upon request.

- Pre-Galvanized Steel (ASTM A653 SS Grade 33, G90)
- Hot Dip Galvanized (ASTM A123)
- Zinc Trivalent Chromium (ZTC) (ASTM B633)
- Powder-Coated



H-STRUT CHANNEL

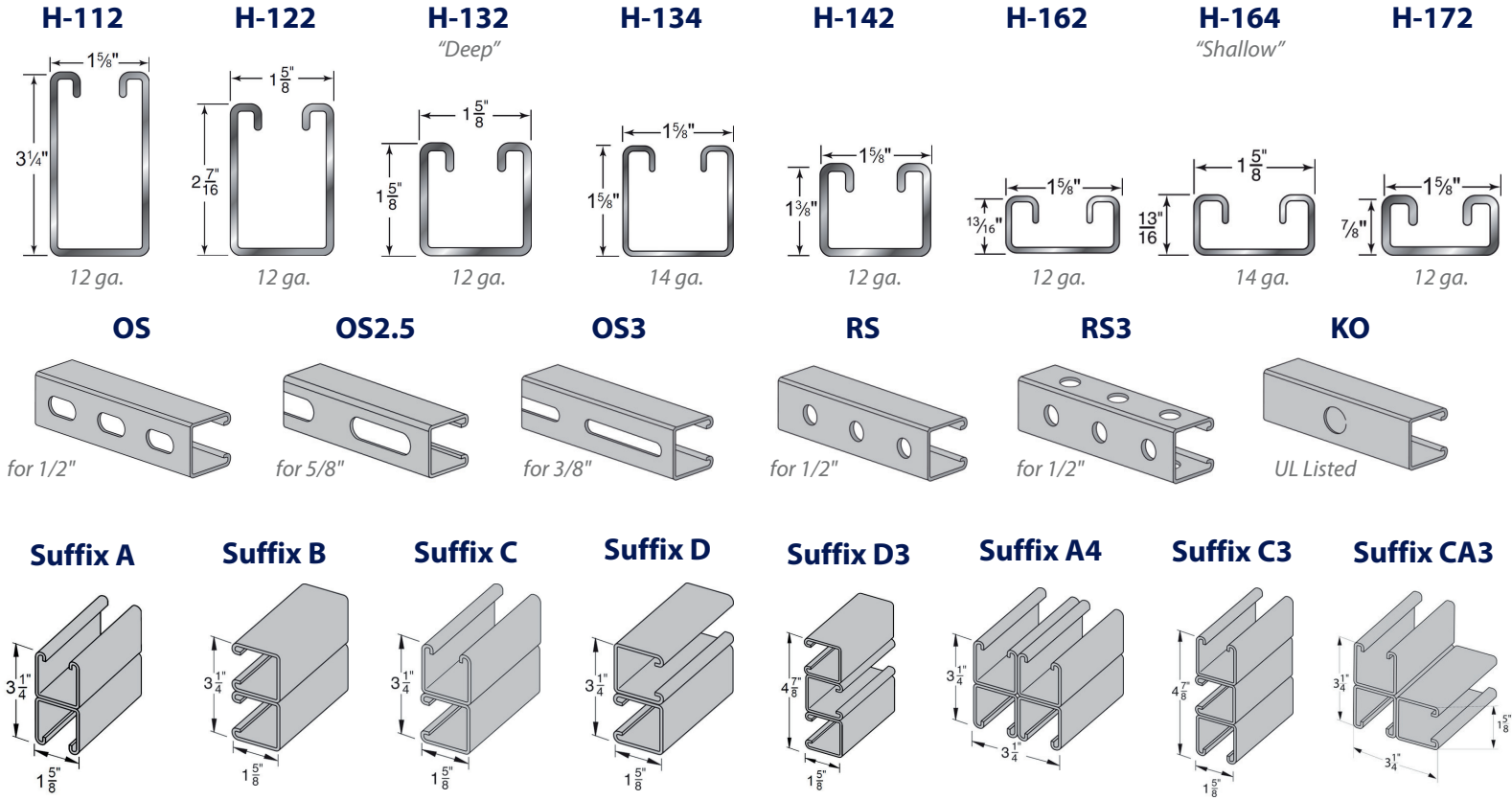

ACCESSORIES

Domestic and Import Available

Channel Nuts

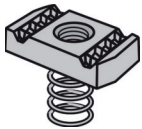

Brackets

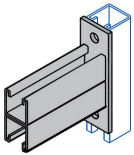

Clamps

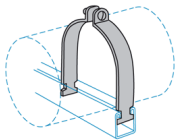

Post Base

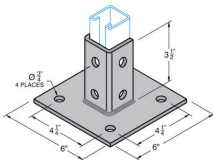

Fittings

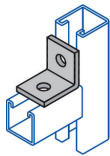

Beam Clamp

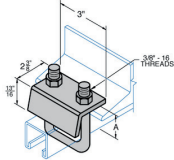

Channel

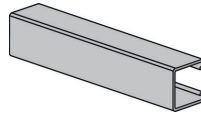

Connector Plate

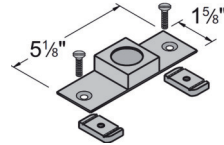

KO

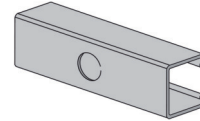

End Cap

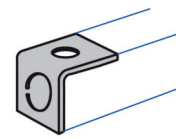

Closure Strip

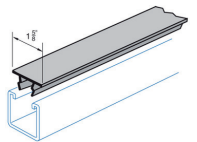

Raceway Hanger

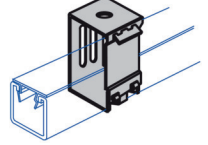

Threaded Rod



UL Listed #E344910



Buy American Act Compliant | LEED Certifiable | Recovery Act Compliant (ARRA) | UL Listed Electrical Products

1-800-242-9366 | haydoncorp.com | contactus@haydoncorp.com



© Copyright 2025 by Haydon Corporation. All rights reserved.
All trademarks and service marks denoted with TM, SM, or ® are owned by Haydon Corporation unless otherwise noted. HC020468 05/2025