



**T&A supply company, Inc.**

## TABLE OF CONTENTS

### ADHESIVES

4-9

Selector Guide	4
Featured Adhesives	5
Carpet Adhesives & Seam Sealers	6
Resilient / Pressure Sensitive	7
Hardwood Adhesives	8
Cove Base Adhesives	8
Specialty Adhesives	9

### TROWELS

10-11

Carpet, Sheet Vinyl, VCT, LVT, Hardwood Trowels	10
Ceramic & Stone, Handles, Systems, Finish Trowels	11

### SUBFLOOR PREP

12-16

Self Leveling	12
Subfloor Shims & Leveling	13
Self Leveling Fibers & Pins	13
Self Leveling Tools	13
Primer	14
Patch & Ramp	14
Moisture Mitigation	15
Mixers & Accessories	15
Equipment & Accessories	16

### CARPET SUPPLIES

17-19

Tackstrip	17
Staples	17
Seam Tape	18-19
Carpet Nails	18

### CARPET TOOLS

20-24

Blades & Knives	20
Knife Pouches	21
Carpet Cutting Tools	21
Carpet Seaming Tools	22
Seaming Products	22
Glue Guns	22
Kickers & Stretchers	23
Electric Tacker/Hammer Tackers	24

## TABLE OF CONTENTS

### HARD SURFACE TOOLS

24-29

Heat Welding	24
Hardwood Nailers & Staplers	25
Flooring Cutters	25
Vinyl Hand Tools	26
Floating Floor Accessories	27
Laminate Installation Tools	27
Wall Base Installation	27
Hand Scrapers & Blades	28
Knee Pads	29

### UNDERLAYMENT

30-31

Plywood Underlayment	30
Sound Reduction Underlayment	31

### TRANSITIONS

32-39

Johnsonite Base & Transitions (East)	32
Roppe Base & Transitions (West)	33
Plastice Laminate Trims	34
Treadsafe	34
Metal Carpet Transitions	35
LVP-LVT Transitions	36
Schluter Profiles	37-39

### TILE & STONE SUPPLIES

40-48

Mortar & Thinset	40-41
Grout, Silicone, Caulk	42-43
De-Haze & Cleaners	44
Sealers	44
Waterproofing	45
Ceramic Cutting Tools & Blades	46
Tile Leveling & Spacers	47
Ceramic Hand Tools	47
	48

### SHOWER SYSTEMS

49-

Membranes	49
Crack Isolation & Anti-Fracture	49

# SELECTOR GUIDE

# FEATURED ADHESIVES

ADHESIVE

ADHESIVES

CATEGORY	STYLE	POWERHOLD	TAYLOR	SPRAYLOCK	OTHER
<b>CARPET</b>	Double Glue	PH-4000 (good)	2055 (best)		Shaw 1000
	Premium	PH-4000	Agile		
	Action Back Economy	PH-2000			
	Outdoor (non-urethane)		757		
	Outdoor (urethane)		Resolute		
	Carpet Tile (PVC)		Versatile	6500	Shaw 5000
<b>CARPET PAD</b>	Solvent Based		720		
	Acrylic Based		722		
<b>CARPET SEAM SEALER</b>	Glue Down Solvent Based		775		
	Acrylic Sol-Free				Traxx Fusion
	100% Pure Latex		710		
	Hot Melt Adhesive				Kool-Stick
<b>MULTI-PURPOSE</b> (felt back vinyl - action bac carpet)	Premium	PH-3000			
	Contractor	PH-2000			
<b>GLASS-BACK SHEET VINYL</b>	Fiberglass-Back Sheet		Pinnacle, Resolute		Uzin 2000S
<b>SOLID SHEET VINYL</b>	Homo-Heterogeneous		Pinnacle, Resolute	3500	Uzin 2000S
<b>RESILIENT</b> Extreme	100% RH		Resolute		
<b>LUXURY VINYL</b> (LVP/LVT)	Heavy Commercial		Pinnacle	6500	Uzin 2000S
	Multi-Family		Dynamic	6500	Uzin 2000S
<b>VCT</b>	VCT	PH-1500 Green Lid	Steadfast		
<b>LINOLEUM</b>	Linoleum		Resolute		Uzin 2000S
<b>WALL BASE</b>	Rubber & Vinyl	PH-5500	Finale		TA-9640
<b>WOOD BAMBOO CORK</b>	100% RH Solid Engineered		Ridgeline		
	Solid & Engineered		Ironwood Aspen		
	Glue Assist		Ironwood		
	Urethane		Timberline		
<b>CERAMIC MASTIC</b>	Floor-Wall		Odyssey 901		Laticrete #15 Reliabond
<b>CONTACT ADHESIVE</b>	Flammable Brush Grade		1-N		
	Aerosol Spray		725		
<b>RUBBER</b>	Sheet, Tile, Crumb Rubber		Pinnacle, Resolute		Uzin KE-66
<b>STAIR TREAD</b>			Pinnacle, Resolute		JO-965



## RESOLUTE SKU WFRESOLUTE2 | 2 Gallon

### Recommended Uses:

- Outdoor Carpet & Turf
- Sheet Vinyl
- Linoleum
- Crumb Rubber
- Rubber Sheet & Tile
- Stair Treads

### Features:

- Coverage: 50-250 sf/gal
- Adhesive & Moisture Barrier in One!
- No Moisture or pH Testing
- No Moisture Barrier Required
- 45 Minute Working Time
- 6 Hour Cure



## PINNACLE SKU WFPINNACLE1 / WFPINNACLE4 | 1 and 4 Gallon

### Recommended Uses:

- Heavy Commercial LVT
- Sheet Vinyl
- Linoleum
- Crumb Rubber
- Rubber Sheet & Tile
- Stair Treads

### Features:

- Coverage: 150-350 sf/gal
- Ideal for Heavy Rolling Loads
- Immediate Access for Light Traffic
- 99% RH
- 3 Hour Working Time
- 12 Hour Cure



## 6500

SKU SL6500 | 22 oz

### Recommended Uses:

- Carpet Tile
- LVT/LVP

### Features:

- Coverage: 150-185 sf
- No Trowelling
- Immediate Access for Traffic
- Instant Strength

## KE 2000 S

SKU UZKE2000S1 | 1 Gallon

SKU UZKE2000S3 | 3.08 Gallon



### Recommended Uses:

- Felt Back and Solid Sheet Vinyl
- Heavy Commercial LVT/LVP
- Linoleum

### Features:

- Coverage: 75 - 210 sf/gal
- Porous and Non-Porous Substrates
- Plasticizer resistant
- Excellent bond strength

## CARPET ADHESIVES & SEAM SEALERS

	<b>TAYLOR 2055</b> # WF20554	<b>SIZE</b> 4 Gallon	<b>APPLICATION</b> Double Glue Broadloom Carpet	<b>COVERAGE</b> 110-160 sf/gal	<b>RH</b> 90%	<b>PH</b> 5-9
	<b>TAYLOR AGILE</b> # WFAGILE4	<b>SIZE</b> 4 Gallon	<b>APPLICATION</b> Broadloom Carpet	<b>COVERAGE</b> 50 -180 sf/gal	<b>RH</b> 90%	<b>PH</b> 5-9
	<b>TAYLOR 757</b> # WF7574	<b>SIZE</b> 4 Gallon	<b>APPLICATION</b> Solvent Based Outdoor Carpet	<b>COVERAGE</b> 50-100 sf/gal		
	<b>TAYLOR VERSATILE</b> # WFVERSATILE1 # WFVERSATILE4	<b>SIZE</b> 1 Gallon 4 Gallon	<b>APPLICATION</b> Pressure Sensitive Carpet Tile	<b>COVERAGE</b> 150-350 sf	<b>RH</b> 95%	<b>PH</b> 5-10
	<b>TAYLOR 722</b> # WF7221	<b>SIZE</b> 1 Gallon	<b>APPLICATION</b> Water Based Carpet Pad	<b>COVERAGE</b> appx 200 sf/gal	<b>RH</b> 75%	<b>PH</b> 5-9
	<b>TAYLOR 720</b> # WF7201	<b>SIZE</b> 1 Gallon	<b>APPLICATION</b> Solvent Based Carpet Pad	<b>COVERAGE</b> appx 500 sf/gal		
	<b>TAYLOR 775</b> # WF775QT	<b>SIZE</b> 1 QT	<b>APPLICATION</b> Solvent Based Seam Sealer	<b>COVERAGE</b> 360 lf/qt		
	<b>TAYLOR 710</b> # WF710QT	<b>SIZE</b> 1 QT	<b>APPLICATION</b> Latex Seam Sealer	<b>COVERAGE</b> 300 lf/qt		
	<b>POWERHOLD 2000</b> # PH20004	<b>SIZE</b> 4 Gallon	<b>APPLICATION</b> Multipurpose Carpet & Sheet Vinyl	<b>COVERAGE</b> 72-250 sf/gal		
	<b>POWERHOLD 3000</b> # PH30001 # PH30004	<b>SIZE</b> 1 Gallon 4 Gallon	<b>APPLICATION</b> Premium Multipurpose Carpet & Sheet Vinyl	<b>COVERAGE</b> 72-250 sf/gal		
	<b>POWERHOLD 4000</b> # PH40004	<b>SIZE</b> 4 Gallon	<b>APPLICATION</b> Double Glue/Fast Grab Broadloom Carpet	<b>COVERAGE</b> 72-250 sf/gal		
	<b>TRAXX FAST FUSION</b> # TRTTX885008 # TRTTX885032	<b>SIZE</b> 8 oz 32 oz	<b>APPLICATION</b> Acrylic Seam Sealer	<b>COVERAGE</b> ?		

**Shaw 1000**  
4 Gallon | WF10004  
Double Glue

**Shaw 5000**  
4 Gallon | WF50004  
Pressure Sensitive-Tile

**Koolstick**  
10" x 10 Sticks | SEKOOLSTICK  
UV Tracer Seam Sealer  
View Page 22 for Glue Guns

## RESILIENT / PRESSURE SENSITIVE



### TAYLOR DYNAMIC | MODIFIED PRESSURE SENSITIVE

<b>ITEM #</b> # WFDYNAMIC1 # WFDYNAMIC4	<b>SIZE</b> 1 Gallon 4 Gallon	<b>APPLICATION</b> Multi-Family Glue Down LVT	<b>COVERAGE</b> 90-350 sf/gal	<b>RH</b> 99%	<b>PH</b> 5-12
---	-------------------------------------	---	----------------------------------	------------------	-------------------



<b>TAYLOR STEADFAST</b> # WFSTEADFAST1 # WFSTEADFAST4	<b>SIZE</b> 1 Gallon 4 Gallon	<b>APPLICATION</b> Heavy Comm. VCT	<b>COVERAGE</b> 220-300 sf/gal	<b>RH</b> 90%	<b>PH</b> 5-9
---	-------------------------------------	--	-----------------------------------	------------------	------------------



<b>TAYLOR VERSATILE</b> # WFVERSATILE1 # WFVERSATILE4	<b>SIZE</b> 1 Gallon 4 Gallon	<b>APPLICATION</b> Pressure Sensitive LVP, VCT, Sheet	<b>COVERAGE</b> 150-350 sf	<b>RH</b> 95%	<b>PH</b> 5-10
---	-------------------------------------	---	-------------------------------	------------------	-------------------



<b>POWERHOLD 6100</b> # PH61004	<b>SIZE</b> 4 Gallon	<b>APPLICATION</b> Felt Back Sheet Vinyl	<b>COVERAGE</b> appx 250 sf/gal		
------------------------------------	-------------------------	--	------------------------------------	--	--



<b>POWERHOLD 1500</b> # PH15004	<b>SIZE</b> 4 Gallon	<b>APPLICATION</b> Heavy Comm. VCT	<b>COVERAGE</b> 350-400 sf/gal	<b>RH</b> 90%	<b>PH</b> 5-9
------------------------------------	-------------------------	--	-----------------------------------	------------------	------------------



<b>UZIN KE 2000 S</b> # UZKE2000S1 # UZKE2000S3	<b>SIZE</b> 1 Gallon 3.08 Gallon	<b>APPLICATION</b> Heavy Comm. Sheet & LVT	<b>COVERAGE</b> 75-210 sf/gal	<b>RH</b> 85%	<b>PH</b> 5-9
---	--	--	----------------------------------	------------------	------------------



<b>SPRAYLOCK 3500</b> # SL3500	<b>SIZE</b> 22 oz	<b>APPLICATION</b> Sheet Vinyl	<b>COVERAGE</b> 150-185 sf/can	<b>RH</b> 98%	<b>PH</b> 11
-----------------------------------	----------------------	-----------------------------------	-----------------------------------	------------------	-----------------



<b>SPRAYLOCK 6500</b> # SL6500	<b>SIZE</b> 22 oz	<b>APPLICATION</b> Heavy Comm. LVT	<b>COVERAGE</b> 160-190 sf/can	<b>RH</b> 98%	<b>PH</b> 11
-----------------------------------	----------------------	--	-----------------------------------	------------------	-----------------



<b>SPRAYLOCK 9500</b> # SL9500	<b>SIZE</b> 22 oz	<b>APPLICATION</b> Heavy Comm. VCT	<b>COVERAGE</b> 170-210 sf/can	<b>RH</b> 98%	<b>PH</b> 11
-----------------------------------	----------------------	--	-----------------------------------	------------------	-----------------

## HARDWOOD ADHESIVES



### TAYLOR RIDGELINE | 100% RH WOOD ADHESIVE

RIDGELINE	SIZE	APPLICATION	COVERAGE
# WFRIDGELINE4	4 Gallon	Solid & Engineered, Bamboo, Cork	20-70 sf/gal



IRONWOOD	SIZE	APPLICATION	COVERAGE
# WFIRONWOOD4	4 Gallon	Solid & Engineered, Bamboo, Cork	20-70 sf/gal
# WFIRONWOOD30	28oz		
# WFIRONWOOD20	20 oz		



ASPEN	SIZE	APPLICATION	COVERAGE
# WFASPEN4	4 Gallon	Solid & Engineered, Bamboo, Cork	20-70 sf/gal



TIMBERLINE URETHANE	SIZE	APPLICATION	COVERAGE
# WFTIMBERLINE4	4 Gallon	Solid & Engineered, Bamboo, Cork	20-180 sf/gal



2049	SIZE	APPLICATION	COVERAGE
# WF204916	16 oz	Tongue & Groove	400 lf/16 oz

## SPECIALTY ADHESIVES



### UZIN KE 66 | WET SET ADHESIVE

KE 66	SIZE	APPLICATION	COVERAGE
# UZ81443	3 Gallon	Rubber Sheet & Tile LVT, Sheet Vinyl	130-210 sf/gal



### TAYLOR 1N | CONTACT ADHESIVE

1N-C	SIZE	APPLICATION
# WFIN1	1 Gallon	Contact Cement
# WFIN4	4 Gallon	Permanent Smooth Surface Bond



725 SPRAY	SIZE	APPLICATION
# WF725	12 oz	General Purpose Spray Adhesive

965	SIZE	APPLICATION
# JO9651	1 Gal	Flooring & Tread
# JO9654	4 Gal	



POWERTITE	SIZE
# PHX65611 (ES)	17 Sticks
# PHX65601	17 Sticks
# PHX6560B	374 Sticks

View Page 22 for Glue Guns

## COVE BASE ADHESIVES



### TAYLOR FINALE | HIGH STRENGTH

FINALE	SIZE	APPLICATION	COVERAGE
# WFFINALE4	4 Gallon	Rubber, Vinyl, Rubber/Vinyl Blend	185-500 lf/gal, depending on base height
# WFFINALE1	1 Gallon		
# WFFINALE30	30 oz		
# WFFINALE10	10 oz		

T&A COVE BASE ADHESIVE	SIZE	APPLICATION	COVERAGE
# WFTA964030	30 oz (Purple Tube)	Cove Base Adhesive	60 lf/tube, 4" Base
# WFTA96404	4 Gallon (Purple Lid)		250 lf/gal, 4" Base

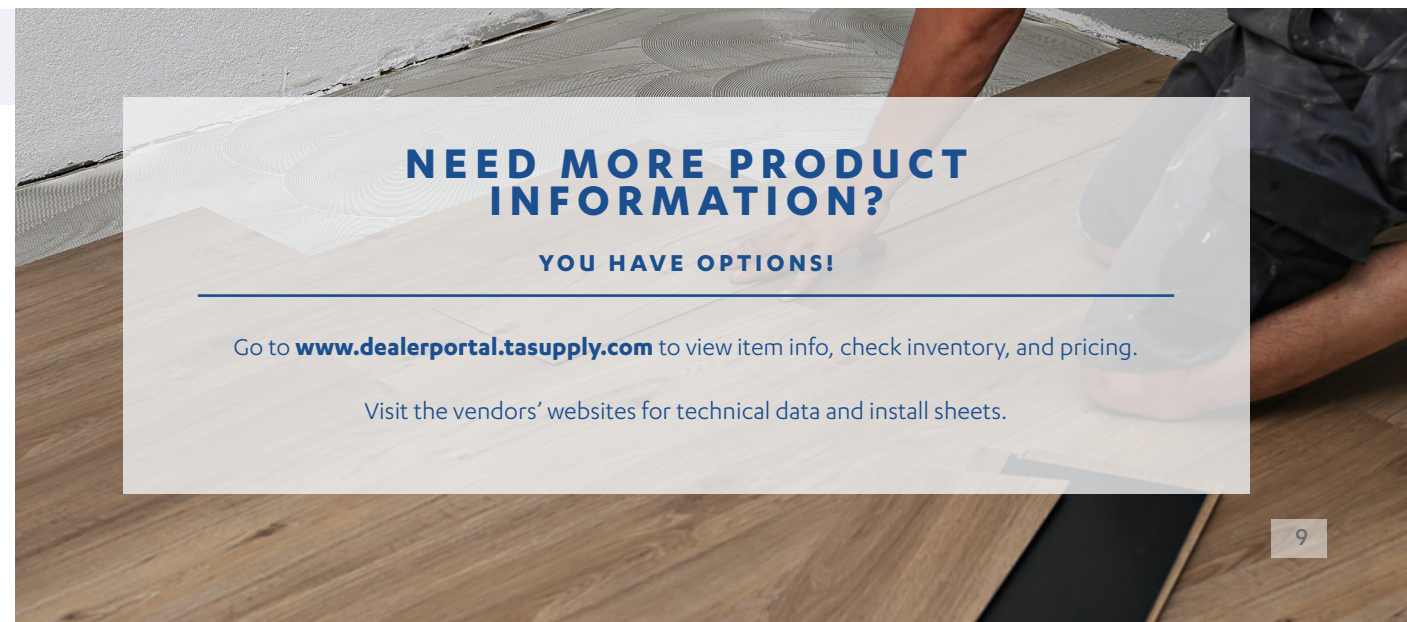

## NEED MORE PRODUCT INFORMATION?

YOU HAVE OPTIONS!

Go to [www.dealerportal.tasupply.com](http://www.dealerportal.tasupply.com) to view item info, check inventory, and pricing.

Visit the vendors' websites for technical data and install sheets.

## TROWEL NOTCH KEY



Width x Depth x Apart





### CARPET ADHESIVE TROWELS

	Notch	Material	Spread	SKU(s)
	1/16" x 1/16" x 1/16"	Vinyl Back	16-18 sy/gal	CR420 FU20056 FU20048 GU680FCA
	3/32" x 3/32" x 3/32"	Smooth Back	12-14 sy/gal	CR424 FU20060 GU680RCA
	1/8" x 1/8" x 1/16"	Action & Unitary Back	10-12 sy/gal	CR423 FU20049 FU20061 GU680FOW
	3/16" x 3/16" x 3/16"	Double Glue Carpet to Pad	6-8 sy/gal	FU20057 GU680MLN

### SHEET VINYL TROWELS

	Notch	Material	Spread	SKU(s)
	1/16" x 1/16" x 1/16"	Commercial Sheet	18-20 sy/gal	FU20052
	1/16" x 1/16" x 1/16"	Residential Sheet	20-25 sy/gal	CR431 GU680ACT
	3/8" Nap Roller	Glassback	25-30 sy/gal	MC735





### VCT & LVT TROWELS

	Notch	Material	Spread	SKU(s)
	1/16 x 1/32 x 5/64	LVT & VCT (non-porous substrate)	300-350 sf/gal	FU20044 GU680WHA
	1/16 x 1/32 x 1/32	LVT & VCT (porous substrate)	250-300 sf/gal	CR422 FU20047 FU20051 FU20063 GU680FFA

### HARDWOOD TROWELS

	Notch	Material	Spread	SKU(s)
	3/16 x 1/4 x 1/2	Wood Flooring (Installed with MS Plus)	60-70 sf/gal	FU20046

### CERAMIC & STONE TROWELS

	Notch	Material	Application	Spread	SKU(s)
	3/16" x 3/32" V	Mosaic/Small Tile	Thinset Mastic	120-130 sf/50lb 50-60 sf/gal	FU20059
	1/4" x 3/16" V	4.25" x 4.25" Wall	Thinset Mastic	110-120 sf/50lb 50-60 sf/gal	CR425 FU49116 GU680CWM
	1/4" x 1/4" x 1/4"	8" x 8" Tile	Thinset Mastic	80-90 sf/50lb 30-40 sf/gal	CR426 FU49100 GU680CTB BEPTSJ06
	1/4" x 3/8" x 1/4"	12" x 12" Tile Up to 20" x 20" Slate & Pavers	Thinset Mastic	80-90 sf/50lb 30-40 sf/gal	CR428 FU49112 GU680CTB
	1/2" x 1/2" x 1/2"	Marble & Granite	Thinset	40-45 sf/50lb	CR429 FU49038 BEPTSJ12

### HANDLES



**FUTURA RUBBER HANDLES**  
Standard and XL  
Available in select trowel options listed above (FU\_\_ SKUs)



**CRAIN WOOD HANDLE**  
Available in select trowel options listed above (CR\_\_ SKUs)

### TROWEL SYSTEMS



**VERSABLADE**  
Interchangeable blades with three handle options.



**BIHUI TROWEL KIT #BEPTSJG8**  
Storage box, rubber handle, 6 interchangeable blades  

- 3/16", 1/4", 5/16", 3/8" Square Notch
- 1/4" x 1/2" x 3/4" U Notch
- Tiger Notch Blade

 Replacement Blades Available

### FINISH TROWELS



SIZE	HANDLE	SKU
14"	Rubber Handle	FU20062
14"	Wood Handle	CR434
16"	Rubber Handle	GUCF416
18"	Rubber Handle	GUCF418

## SELF LEVELING



**NC 150** SKU UZ77346 | 50lb | Portland Based Self Leveling Compound

**Recommended Uses:**

- Interior Use
- Over existing hard surface, underlayment, or adhesive residue
- Under carpet, resilient, ceramic, and wood floor covering
- Residential or Commercial

**Features:**

- Coverage: 29 sf/50lb at ¼" Thickness
- Depth: ⅛" to 1" (1.5 mm - 25 mm)
- Work Time: 20-40 minutes
- Foot Traffic: 2-3 Hours
- Dry Time: 24 Hours
- PSI: 4,500 compressive



**NC 150 F CEMENT**  
UZ77347

COVERAGE (¼")	DEPTH	WORK TIME	FOOT TRAFFIC	DRY TIME	PSI (COMPRESSIVE)
29 sf/50 lb bag	⅛" - 1"	20-40 min	2-3 hr	24 hr	4,500



**NC 157 CEMENT**  
UZ77347

COVERAGE (¼")	DEPTH	WORK TIME	FOOT TRAFFIC	DRY TIME	PSI (COMPRESSIVE)
13.5 sf/50 lb bag	¼" - 2"	20-40 min	2-4 hr	24 hr	6,000



**NC 170 CEMENT**  
UZ77348

COVERAGE (¼")	DEPTH	WORK TIME	FOOT TRAFFIC	DRY TIME	PSI (COMPRESSIVE)
30 sf/50 lb bag	⅛" to unlimited	20-40 min	2 hr	3-24 hr	6,000



**NC 172 TURBO CEMENT**  
UZ77349

COVERAGE (¼")	DEPTH	WORK TIME	FOOT TRAFFIC	DRY TIME	PSI (COMPRESSIVE)
30 sf/50 lb bag	⅛" to unlimited	15 min	1 hr	1-12 hr	8,000



**NC 110 GYPSUM**  
UZ83246

COVERAGE (¼")	DEPTH	WORK TIME	FOOT TRAFFIC	DRY TIME	PSI (COMPRESSIVE)
30 sf/50 lb bag	⅛" - 2"	20-30 min	2 hr	See website	5,200



**NC 144 LIGHT**  
UZ144LW

COVERAGE (¼")	DEPTH	WORK TIME	FOOT TRAFFIC	DRY TIME	PSI (COMPRESSIVE)
30 sf/33 lb bag	¼" - 2"	20 min	3-4 hr	24-72 hr	3,000



**NXT LEVEL FLOW**  
LANXTLEV-ELFLOW50

COVERAGE (¼")	DEPTH	WORK TIME	FOOT TRAFFIC	DRY TIME	PSI (COMPRESSIVE)
22 sf/50 lb bag	⅛" - 2"	20 min	3-4 hr	48 hr	4,000



**NXT LEVEL**  
LANXTLEV-EL50

COVERAGE (¼")	DEPTH	WORK TIME	FOOT TRAFFIC	DRY TIME	PSI (COMPRESSIVE)
22 sf/50 lb bag	⅛" - 3"	20 min	2-3 hr	24 hr	5,000

## SUBFLOOR SHIMS & LEVELING

ROPPE (West)		Johnsonite (East)		Particle Board	
Size	SKU	Size	SKU	Size	SKU
⅛" x 12" x 4'	RO304100	⅛" x 12" x 4'	JOLS40F	¼" x 8" x 32"	BNP20832
¼" x 12" x 4'	RO302100	¼" x 12" x 4'	JOLS40	⅜" x 8" x 32"	BNP30832
⅜" x 12" x 4'	RO301100	⅜" x 12" x 4'	JOLS40D	½" x 8" x 32"	BNP50832
½" x 18" x 4'	RO303100	½" x 12" x 4'	JOLS40E		

## SELF LEVELING FIBERS & PINS



**REINFORCING FIBER**

**SKU** UZ11725  
1 Bag per 50lbs of Leveler  
Add to leveler to reduce cracking

**FIBERGLAS MAT RR 203**

**SKU** UZ79682  
2' Wide x 2.6' Long  
Bridges substrate cracks and joints up to ¼" wide with maximum ⅜" movement

**LEVELING PINS**

**SKU** UZPIN20  
20/package  
For leveling compound

## SELF LEVELING TOOLS



**LEVELING RAKE**

**SKU** WO52298  
Leveling Rake with Insert



**24" GAUGE RAKE**

**SKU** UZ59771  
24" with Adjustable Sleds



**22" SMOOTHER**

**SKU** UZ59361

**MIXING DRUM KIT**

**SKU** UZ59973  
Mix Drum, Gauge Rake, Smoother, Oval Mixing Paddle, Water Buckets  
Handle Sold Separate

**16 GALLON DRUM**

**SKU** UZ59267  
60 Liters / 16 Gallons  
For Leveling Compounds

**MIXING PADDLES**

**Flat Cage Paddle** **SKU** UZ13606  
**Oval Paddle** **SKU** UZ59597

**SPIKE ROLLER**

**10" SKU** UZ13637  
**29" SKU** UZ13638  
Spike Length: 1.2"

**TELESCOPING POLE**

**SKU** UZ12503  
Use for Smoothing Rake & Spike Roller

**SHOE-IN SPIKE SHOES**

**Medium** **SKU** SHMEDIUM  
**Large** **SKU** SHLARGE  
**XL Large** **SKU** SHXLARGE









**8 GALLON BUCKET**

**SKU** UZ9191  
30 Liters / 8 Gallons  
Leveling Compounds and Primers

**2.4 GALLON BUCKET**

**SKU** UZ10412  
9 Liters / 2.4 Gallons  
Graduated Measuring Bucket

## PRIMER

	<b>PE 260</b> UZPE2601 UZ79280	<b>SIZE</b> 1 Gal 2.6 Gal	<b>COVERAGE</b> 300-460 sf/gal (undiluted)	<b>SUBSTRATE</b> Porous & Non-Porous	<b>DRY TIME</b> 1-2 Hr
	<b>PE 280 FAST</b> UZ79279	<b>SIZE</b> 2.6 Gal	<b>COVERAGE</b> 460-710 sf/gal	<b>SUBSTRATE</b> Non-Porous	<b>DRY TIME</b> 45 min
	<b>PE 360</b> UZPE3601 UZPE3602.6	<b>SIZE</b> 1 Gal 2.6 Gal	<b>COVERAGE</b> Up to 600 sf/gal	<b>SUBSTRATE</b> Porous	<b>DRY TIME</b> 30-60 min
	<b>NXT PRIMER</b> LANXTPRIMER1	<b>SIZE</b> 1 Gal	<b>COVERAGE</b> 100 sf/gal	<b>SUBSTRATE</b> Porous	<b>DRY TIME</b>
	<b>2025 LATEX</b> WF20251 WF20254	<b>SIZE</b> 1 Gal 4 Gal	<b>COVERAGE</b> 300-450 sf/gal	<b>SUBSTRATE</b> Porous	<b>DRY TIME</b> 30-60 min
	<b>ZEPHYR ENCAPSULATOR</b> WFZEPHYR4	<b>SIZE</b> 4 Gal	<b>COVERAGE</b> 200-350 sf/gal	<b>SUBSTRATE</b> Porous	<b>DRY TIME</b> 1-2 Hr
	<b>ENHANCE ENCAPSULATOR</b> WFEHANCE2	<b>SIZE</b> 2 Gal	<b>COVERAGE</b> Up to 250 sf/gal	<b>SUBSTRATE</b> Porous & Non-Porous	<b>DRY TIME</b> 1-2 Hr
	<b>PRIME-N-BOND</b> LAPRIMENBOND1	<b>SIZE</b> 1 Gal	<b>COVERAGE</b> 150-300 sf/gal	<b>SUBSTRATE</b> Non-Porous	<b>DRY TIME</b> 15-60 min

## PATCH & RAMP



	<b>UZLN 888</b> UZ77351	<b>SIZE</b> 10 lb	<b>FEATURES</b> "Sticks to Glass!"	<b>THICKNESS</b> 1" to Feather	<b>DRY TIME</b> 10-15 min
	<b>UZLN 886</b> UZ77352	<b>SIZE</b> 10 lb	<b>FEATURES</b> Skim & Patch	<b>THICKNESS</b> ½" to Feather	<b>DRY TIME</b> 10-15 min
	<b>UZLN 890</b> UZ159352	<b>SIZE</b> 10 lb	<b>FEATURES</b> Moisture Resistant	<b>THICKNESS</b> ½" to Feather	<b>DRY TIME</b> 10-15 min
	<b>UZLN 182</b> UZ77350	<b>SIZE</b> 20 lb	<b>FEATURES</b> Deep Fill & Ramp	<b>THICKNESS</b> Unlimited to Feather	<b>DRY TIME</b> 10-15 min
	<b>WEBCRETE 95</b> DA9525	<b>SIZE</b> 25 lb	<b>FEATURES</b> Skim & Patch	<b>THICKNESS</b> ½" to Feather	<b>DRY TIME</b> 25-35 min
	<b>WEBCRETE 98</b> DA9825	<b>SIZE</b> 25 lb	<b>FEATURES</b> Polymer Modified	<b>THICKNESS</b> ½" to Feather	<b>DRY TIME</b> 55-65 min
	<b>D-9001</b> DAD900125	<b>SIZE</b> 25 lb	<b>FEATURES</b> Gypsum Patch	<b>THICKNESS</b> ½" to Feather	<b>DRY TIME</b> 25-35 min

## MOISTURE MITIGATION See page 48 for crack isolation & membranes

### LIQUIDSHIELD 100 | ROLL-ON MOISTURE BARRIER

ITEM #	SIZE	FEATURES	RH	PH	COVERAGE
# TRLSU010001	1 Gallon	Roll on, No	100%	14	200-250 sf/gal
# TRLSU010005	5 Gallon	Testing Required			



**VAPORSHIELD MOISTURE MEMBRANE**  
100% RH | 14 pH | No Moisture Testing Req.  
**720 sf/roll** #TRVSU30100  
**Tape** #TRTSU40200T3



**6MIL POLY VAPOR BARRIER FILM**  
**120 sf/roll** #FOPOLY

**SILICONE VAPOR SHIELD**  
**400 sf/roll** #AGSVS400

\* See also page 14 for Zephyr moisture mitigation up to 95% RH



**PE 460 2-PART EPOXY MOISTURE CONTROL**  
100% RH | 14 pH | No Moisture Testing Req.  
**2.5 Gallon** #UZPE4602.5



**PE 414 SURFACE STRENGTHENING PRIMER**  
90% RH | 14 pH  
Acts as a strengthener and barrier coat on absorbent or non-porous substrates.  
**2.6 Gallon** #UZ63940

## MIXERS & ACCESSORIES



**MEGA HIPPO**  
**Mobile Mixing Station**  
# POPMHX80HD110 | **2500W - 110V**  
# POPMH80110 | **1800W - 110V**



**PELICAN**  
**Cart and Dust Control**  
SKU POPMP80DC  
**Cart Only** SKU POPMP80



**BADGER MINI MIXER**  
Includes: Cart, 20 gal. Mixing Drum, Mixer Bracket, Mixing Paddle, Drill Adapter, Vacuum Hose Holder  
**Badger** SKU POPMB60  
**Replacement Canister** SKU POPB600  
**Replacement Paddle** SKU POTWP160

**MEGA HIPPO MOTORS**  
**Standard Motor** SKU POPH1816S110V  
**Heavy Duty Motor** SKU POPH2516R110

**RIMLESS LINER**  
SKU POPH705  
For Pelican and Mega Hippo

**HAND MIXER**  
**1800W - 110V** SKU POEM182R110



## EQUIPMENT & ACCESSORIES

### SAND PAPER RESIN CONSTRUCTION

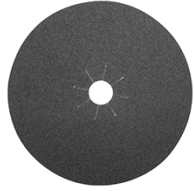

WIDE	GRIT	ITEM #	WIDE	GRIT	ITEM #
7"	12	TRTXA077812	16"	20	TRTXA160220
7"	16	TRTXA077816	16"	36	TRTXA160236
7"	20	TRTXA077820	16"	50	TRTXA160250
16"	12	TRTXA160212	16"	60	TRTXA160260
16"	16	TRTXA160216	16"	80	TRTXA160280

### CARBIDE DISK FITS 15" & 16" BUFFER

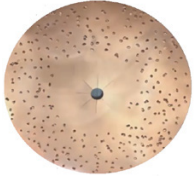

WIDE	GRIT	ITEM #
15"	14	WO50849
15"	16	WO13510
15"	24	WO13517



### SEGMENTS

Compatible with Neo Grinder  
**BT K20 for Concrete Profiling**  
 Item #WO68390  
**ES K20 for Soft Concrete**  
 Item #WO68391  
**PCD for Adhesive & Mortar**  
 Item #WO68388  
**PCD Wolff Trap for Aggressive Profile**  
 Item #WO162589



### INDEPENDENCE RIDE ON STRIPPER

33" Wide, Battery Powered  
 Remote or Ride-On Control  
 6-10 hr Run Time, 5-10 hr Charge  
 Item #WO172770



### SAMBA

Comes with Dust  
 Containment  
 645 - 1075 sf/hr  
 Item #WO086033



### NEO 230

Versatile grinding machine  
 9" Grinding area  
 Requires 4 Segments  
 Item #WO75382



### HEPA VACUUM

OSHA Compliant H14 Filter  
 Contained dust collection  
 Item #WO81706



### PRE-SEPARATOR

Separates dust before  
 reaching the vacuum  
 Item #WO82215



### SANDPAPER DRIVERS

Attachment for 17" Machine  
 Item #TA4851710  
 Universal plate for 15" and  
 16" Sandpaper  
 Item #WO84750



### DURO STRIPPER

Versatile push or hand held  
 operation. Small-med jobs.  
 320-540 sf/hr  
 Replacement blades available  
 Item #WO85642



### TURBO STRIPPER

Heavy duty floor stripper  
 for most types of bonded  
 surfaces | 645-1075 sf/hr  
 Replacement blades available  
 Item #WO39086



### CORDLESS JR STRIPPER

Hand-held for removing small  
 areas of carpet, foam, residues  
 Replacement blades available  
 Item #WO010334

## TACKSTRIP

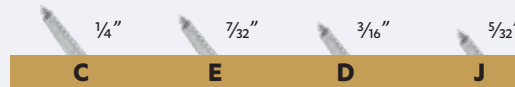

SKU	Tackstrip Width	Pin Profile	Nail	Wood Strip	LF/Ctn
TRHPS4249	7/8"	E Pin	1 1/4" Acoustical Nail	Premium Birch	400
TRPPS4421	1"	C Pin	1" Wood Nail	Premium Birch	400
PHS4442	1"	E Pin	5/8" Concrete Nail	Premium Birch	400
TRHPS4410	1"	E Pin	No Nail	Premium Birch	400
TRHPS4410S	1"	D Pin	No Nail	Premium Birch	400
TRHPS4410XS	1"	J Pin	No Nail	Premium Birch	400
TRMXS4620	1 1/4"	E Pin	3/4" Wood Nail	Premium Birch	280
TRMXS4642	1 1/4"	E Pin	5/8" Concrete Nail	Premium Birch	280
TRHPS4610	1 1/4"	E Pin	No Nail	Premium Birch	280
TRMXS4842	1 3/4"	E Pin	5/8" Concrete Nail	Premium Birch	200
TRHPS4810	1 3/4"	E Pin	No Nail	Premium Birch	400
PHS4421	1"	E Pin	1" Wood Nail	Premium Poplar	400
TRPPS4442	1"	E Pin	5/8" Concrete Nail	Premium Poplar	400
TRCTS4642	1 1/4"	E Pin	5/8" Concrete Nail	Premium Poplar	280

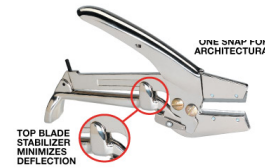

### STRIP CUTTER

Item #CR450  
 12 Blades Item #CR451



### PARABOND M-363

Tackstrip Adhesive  
 Non Flammable Solvent  
 1 Quart Item #PAM363QT



### JET-TAC ADHESIVE

Tackstrip Adhesive  
 Quick Set Epoxy  
 10 oz Item #SO650651  
 3 Nozzles Item #SO650650



### INVISINAIL 949

1-part moisture cure polyurethane  
 Stretch in approx. 2 hr  
 10 oz Item #PH94910  
 28 oz Item #PH94928

## STAPLES

See tackers on page 24

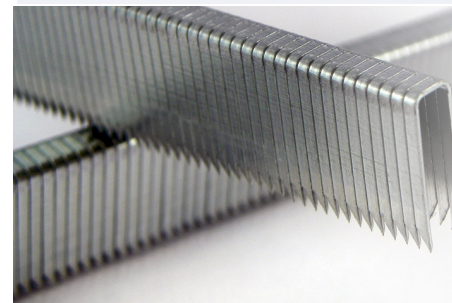

### A11 STAPLE

Divergent Point 3/8"  
 13/32" (20 Gauge)  
 5,000/box  
 Item #TRTXFA1110D

### 5418D STAPLE

Divergent Point 1/16"  
 3/16" (13 Gauge)  
 5,000/box  
 Item #PHF5418D  
 Item #TRTXF5418D

### 7512 STAPLE

Divergent Point 3/8"  
 15/32" (19 Gauge)  
 5,000/box  
 Item #TRTXF7512D

# SEAM TAPE

See seaming tools on page 22

## DOUBLE GLUE



**SEAM MASTER**  
Double Stick Pressure Sensitive  
Universal EVA Adhesive  
4" x 66" Roll  
Moderate Setting 2.5  
Item #SEDSPS

## UNIVERSAL EVA ADHESIVES



**PH 390**  
# PHT9490

**FEATURES**  
Wide center bead,  
Universal adhesive  
for all backings

**CARPET**  
Action, Jute, Soft-Bac,  
Woven, Life-Guard,  
UPS, UPS-Flex

**SIZE**  
4" x 66' Roll

**MELT**  
Moderate  
Setting 2.0 to 2.5

**PH 6**  
# PHT8692

**FEATURES**  
22 Beads Amber  
Adhesive

**CARPET**  
Action, Jute, Soft-Bac,  
Woven, Life-Guard

**SIZE**  
6" x 66'

**MELT**  
Moderate  
Setting 2.5



**XU-90**  
# ORXU90

**FEATURES**  
Scrim & fiberglass,  
Heavy center bead

**CARPET**  
Action, Jute, Soft-Bac,  
Woven, Urethane, UPS

**SIZE**  
4" x 66'

**MELT**  
Moderate  
Setting 2.0-2.5

# SEAM TAPE

See seaming tools on page 22

## HEAVY COMMERCIAL - HEAVY RESIDENTIAL

### XK-50



**PH 350**  
# PHT8450

**FEATURES**  
11 Beads, Maximum  
adhesive weight

**CARPET**  
Action, Jute, Soft-Bac,  
Woven, Life-Guard

**SIZE**  
4" x 66' Roll

**MELT**  
Moderate  
Setting 2.0 to 2.5



**TRAXX STIXX**  
# TRS50WBOX  
550W BOX WHITE

**FEATURES**  
100 ft continuous  
tape for long runs

**CARPET**  
Action, Jute, Soft-Bac,  
Woven, Life-Guard

**SIZE**  
4" x 100'  
2 Rolls

**MELT**  
Moderate  
Setting 2.5

**PH 6**  
# PHT8692

**FEATURES**  
22 Beads Amber  
Adhesive

**CARPET**  
Action, Jute, Soft-Bac,  
Woven, Life-Guard

**SIZE**  
6" x 66'

**MELT**  
Moderate  
Setting 2.5



**XK-50**  
# ORXK50

**FEATURES**  
Heavy center bead,  
50% more fiberglass

**CARPET**  
Action, Jute, Woven,  
wilton, axminster

**SIZE**  
4" x 66'

**MELT**  
High  
Setting 3.0-3.5

## LIGHT COMMERCIAL - HEAVY RESIDENTIAL

### XK30, K40



**PH 250**  
# PHT8330

**FEATURES**  
9 Beads, Amber  
Adhesive

**CARPET**  
Action, Jute,  
Soft-Bac, Life-Guard

**SIZE**  
3" x 66' Roll

**MELT**  
Moderate  
Setting 2.5



**TRAXX STIXX**  
# TRS40WBOX  
540W BOX WHITE

**FEATURES**  
100 ft continuous  
tape for long runs

**CARPET**  
Action, Jute,  
Soft-Bac, Life-Guard

**SIZE**  
3" x 100'  
2 Rolls

**MELT**  
Moderate  
Setting 2.5

**SURE GRIP**  
# TRS64

**FEATURES**  
Gold Adhesive,  
Economy

**CARPET**  
Action, Jute,  
Soft-Bac, Life-Guard

**SIZE**  
4" x 66'

**MELT**  
High  
Setting 3



**K-40**  
# ORK40S

**FEATURES**  
Fiberglass  
reinforced

**CARPET**  
Action, Jute,  
latex

**SIZE**  
3.75" x 66'

**MELT**  
High  
Setting 3.0-3.5



**XK-30**  
# ORXK30

**FEATURES**  
Fiberglass  
reinforced

**CARPET**  
Action, SoftBac,  
Difficult carpets

**SIZE**  
4" x 66'

**MELT**  
Moderate  
Setting 2.0-2.5

## STANDARD RESIDENTIAL



**PH 150**  
# PHT8310

**FEATURES**  
9 Beads, Amber  
Adhesive

**CARPET**  
Action, Jute,

**SIZE**  
3" x 66'

**MELT**  
Moderate  
Setting 2.5

# CARPET NAILS

SKU	Type	Length	Gauge	QTY
TRTXN13585	Concrete	1/2"	12	5 lb
TRTXN13611	Concrete	1/4"	12	1 lb
TRTXN14585	Concrete	1/2"	10	5 lb
TRTXN14605	Concrete	5/8"	10	5 lb
TRTXN14621	Concrete	3/4"	10	1 lb
TRTXN18705	Acoustical	1 1/4"	12.5	5 lb
TRTXN11705	Ring Shank	1 1/4"	12	5 lb
TRTXN11745	Ring Shank	1 1/2"	12	5 lb
TRTXN12705	Lath Sm Head	1 1/4"	15	5 lb
TRTXN12365	Plasterboard	1 1/4"	13	5 lb

SKU	Type	Length	Gauge	QTY
TRTXN1726S1	Decorative Silver Large Head	1 1/4"	13	1 lb
TRTXN1722S1	Decorative Silver Counter Sunk	1 1/4"	13	1 lb
TRTXN1728G1	Decorative Gold Large Head	1 1/4"	13	1 lb
TRTXN1724G1	Decorative Gold Large Head	1 1/4"	13	1 lb
TRTXN1734N1	Decorative Nickle Large Head	1 1/4"	13	1 lb
FU489008	Decorative Bronze Large Head	1 1/4"	13	25 pc
CR580	Aluminum Drive	5/8"	1/8"	1 lb
CR780	Aluminum Drive	7/8"	1/8"	1 lb

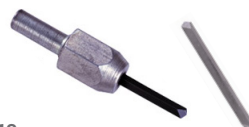

**ADAPTER & CARBIDE BIT**  
Adapter Item #CR225  
Carbide Bit Item #CR223C



**NAIL BAG**  
Random Color Canvas Bag  
Velcro Closure  
Item #TRHN711

## BLADES



**ROUND CORNER SLOTTED**  
 Personna 61-0217  
 100 pack (10 packs of 10)  
**Item #AM610217**

Better Tools  
 100 Pack Dispenser  
**Item #BE20101**  
 100 Pack (10 packs of 10)  
**Item #BE20101T**



**SQUARE CORNER SLOTTED**  
 Personna 61-0223  
 100 pack (10 packs of 10)  
**Item #AM610223**

Better Tools  
 100 Pack Dispenser  
**Item #BE20102N**  
 100 Pack (10 packs of 10)  
**Item #BE20102T**



**UTILITY BLADE**  
 Better Tools  
 100 Pack Dispenser  
**Item #BE20208**  
 100 Pack (10 packs of 10)  
**Item #BE20202**

AMPSB0110

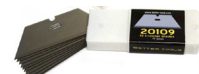

**TRIMMER BLADE**  
 Personna  
 100 pack (10 packs of 10)  
**Item #AM610850**

Better Tools  
 10 Pack  
**Item #BE20109**



**LARGE HOOK**  
 10 Pack **Item #BE20303R**



**MEDIUM HOOK**  
 10 Pack **Item #BE20302**



**CONCAVE HOOK**  
 10 Pack **Item #BE20304**

## KNIVES



**SLOTTED ACTION KNIFE**  
**Item #OR1363**



**SHARK KNIFE**  
 With Case  
**Item #GU101SK**



**HOOK HANDLE**  
 Utility **Item #CR189**  
 Slotted **Item #CR217**



**SLOTTED ACTION**  
 Green **Item #TRTTX6701SG**  
 Orange **Item #TRTTX6701O**  
 Pink **Item #TRTTX6701P**  
 Blue **Item #OR13322**



**STANDARD UTILITY**  
 Green **Item #TRTTX6711G**  
 Orange **Item #TRTTX6711O**  
 Pink **Item #TRTTX6711P**  
 Blue **Item #TRTTX6711B**



**SLOTTED EASY GRIP**  
**Item #CR726**



**SLOTTED PUSH BUTTON**  
**Item #GU230**



**UTILITY - EXTRA GRIP**  
**Item #CR732**



**STANDARD UTILITY**  
**Item #CR730**



**DOLPHIN UTILITY**  
 With Case  
**Item #WO48221**



**MULTI-USE TUCKING**  
**Item #CR175**



**COMBO FIXED BLADE**  
**Item #CR102**



**DEXTER FIXED BLADE**  
**Item #CR060**

## KNIFE POUCHES



**5 POCKET WITH TAPE CLIP**  
**Item #PH701**



**5 POCKET**  
**Item #PH700**



**SINGLE POCKET**  
 Fiber Lined  
**Item #PH408**



**SINGLE POCKET**  
 with Tape Clip  
**Item #PH406**



**FLAT POCKET**  
**Item #PH412**



**SINGLE KNIFE**  
**Item #PH67**



**LEATHER WORK BELT**  
**Item #GU416X**

## CARPET CUTTING TOOLS

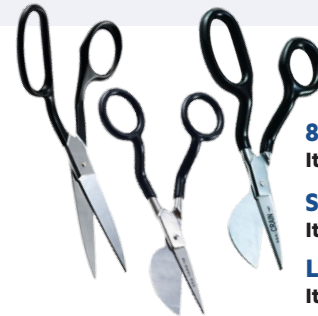

**8" CURVED SHEARS**  
**Item #CR496**

**SMALL DUCKBILL SHEARS**  
**Item #CR190**

**LARGE DUCKBILL SHEARS**  
**Item #CR187**

**WALL TRIMMER**  
 Quick Change Blade  
 Easy Adjust Handle  
**Item #CR496**



**CUSHION BACK CUTTER**  
 Stays in row  
 30° angle blade  
**Item #CR301**

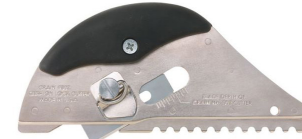

**CUSHION BACK CUTTER**  
 Stays in row, trims close to edge  
 30° angle blade  
**Item #CR302**



**LOOP PILE CUTTER**  
 Adjustable throat  
 30° angle blade  
**Item #CR303**



**STAND UP CUTTER**  
 Cuts carpet into strips for removal.  
**Item #CR265**  
 Replacement Point **Item #CR266**



**LOOP PILE ROW FINDER**  
 Unique action separates  
 even difficult carpet  
**Item #CR366**



**CUT PILE ROW FINDER**  
 Unique action separates  
 even difficult carpet  
**Item #CR367**



**ROW SEPARATOR**  
 For loop or cut pile carpet  
**Item #CR365**

## CARPET SEAMING TOOLS See seam sealers on page 6



### HEAT BOND IRON

- Low profile for end of seams
  - Easy Read Heat Control
  - Even, electric heat
- Item #CR905**



### BLUE-FIN FUSION

- Even heat over entire base
  - Thermostat reduces temp swings
  - Cooler heat shield
- 4" Wide **Item #TRTX6250**  
6" Wide **Item #TRTX6251**



### KOOL GLIDE KGX-6810

- **Heatless** Seaming Tool for carpet and sheet vinyl!
  - No smoke, odor, or VOC
  - No heat distortion carpet damage
  - Seams can be reactivated
  - Includes case & tape guide
- Item #SENEXTECPRO**  
Commercial Tape Item #: SEKGP  
Residential Tape Item #: SEKGS  
Double Stick Tape #: SESUPERDBLTAPE  
Utility Tape Item #: SEUTILITYTAPE



### SEAM BOARD

- Flexible, pulls out at wall
  - Teflon coated
- Item #SEBOARD**

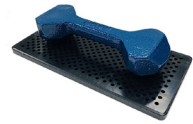

### 12LB SEAM WEIGHT

- Vented to release heat
  - Plastic easy glide base
- Item #TRTTX6220**



### SEAM DOWN NOW

- Stretch Carpet in Minutes!  
Vacuum pulls out heat and moisture and pulls adhesive up to the backing
- Item #TRSDPRO**

## SEAMING PRODUCTS



### ROLLERS

- 4" Star Roller **Item #OR1361**
- 6" Star Roller **Item #OR1360**
- 4" Smooth Roller **Item #OR1374**



### CARPET TRACTOR

**Item #CR476**

### SEAM SQUEEZERS

**Item #CR180**

## GLUE GUNS See glue on page 6, 9



### 300 GLUE GUN

- Adjustable temperature
  - Drip free nozzle
- Item #PHX6300**



### PEAK BUSTER

- Peak Buster and standard nozzles
- Item #OR13251**

## KICKERS & STRETCHERS



### WIDE KNEE KICKER

- Extra row of pins (19 total)
  - Moves wider section with each kick
  - Extra thick bumper
- Item #CR525**  
Pin Plate #: CR152512  
Bumper #: CR1600C



### STANDARD KNEE KICKER

- 5 length settings
  - 3 nap grips, 16 pins
  - Strong construction, 3 yr warranty
- Item #CR445**  
Pin Plate #: CR152512  
Bumper #: CR1505D  
Gripper #: CR1505K



### DELUXE KNEE KICKER

- Rubber neck grip
  - 5 length settings
  - 3 nap grips, 16 pins
- **Item #CR605**  
Pin Plate #: CR1601B  
Bumper #: CR1600C  
Gripper #: CR1505K



### ECONOMY KNEE KICKER

- 5 length settings
  - 3 nap grips, 16 pins
- Item #CR505**  
Pin Plate #: CR1601B  
Bumper #: CR1505D  
Gripper #: CR1505K



### DELUXE SWIVEL LOCK

- 60° swivel with 5 lock points
  - Includes lever extension tube, folding tail block, 3 extension tubes, transfer tube, and carrying case
- Item #CR520**



### DOUBLE CASE STRETCHER

- 60° swivel with 5 lock points
  - Includes stretcher head, tube case, single case, auto-lock tube, transfer tube, folding tail block
- Item #CR499**



### STRETCHER HEAD UNIT

- Fixed head assembly with push button lock
- Item #CR1500U**



### MINI STRETCHER

- Ideal for repairs and pattern matching without tubes
- Item #CR515**

## ELECTRIC TACKER / HAMMER TACKERS

See staples on page 17



### A11 PAD PRO PLUS HAMMER TACKER

Bottom load & quick release  
Heavy duty steel  
**Item #PHXPPA11**



### 7500 PAD PRO HAMMER TACKER

Bottom load  
Easily clear jams  
**Item #PHXPP7500**



### CARBON FIBER HAMMER TACKER

Drop in Loading  
AntiJam™ Pinch Latch  
**Item #DEDWHT75900**



### OPTO POWER TACKER

Narrow profile  
Includes carrying case  
**Item #CR635**



### 5418 EURO POWER TACKER

Industrial Strength  
Low profile  
Includes carrying case  
**Item #TRTTXPP5418**



### DUOFAST POWER TACKER

Industrial grade  
Compact design  
**Item #SOEN5418**

## HARDWOOD NAILERS & STAPLERS

SKU	Gauge	Cleat Length	Flooring Thickness	Operation	Cleats Staples
PN445LSW	16 GA Cleat	1 1/2" - 2"	5/8" - 3/4"	Mallet	1 1/2" <b>Item #PNL150165</b> 1 3/4" <b>Item #PNL175165</b> 2" <b>Item #PNL200165</b>
PN50PFLEXW	18 GA Cleat	1 1/2" - 1 3/4"	3/8" - 3/4"	Mallet	1 1/4" <b>Item #PNL125185</b> 1 1/2" <b>Item #PNL150185</b> 1 3/4" <b>Item #PNL175185</b>
PN50FKIT	18 GA Cleat	1" - 1 3/4"	3/8" - 3/4"	Trigger Pull	1 1/4" <b>Item #PNL125185</b> 1 1/2" <b>Item #PNL150185</b> 1 3/4" <b>Item #PNL175185</b>
PN1845FKIT	18 GA Staple	N/A	3/8" - 5/8"	Trigger Pull	1 1/4" <b>PNPS18125</b> 1 1/2" <b>PNPS18150</b>
PN2000FKIT	20 GA Cleat	1" - 1 1/4"	5/16" - 1/2"	Trigger Pull	1" <b>Item #PNL125185</b> 1 1/4" <b>Item #PNL125205</b>

## HEAT WELDING



### ROLLING HAND GROOVER

Cuts grooves for heat welding.  
**Item #CR973**  
Blades **Item #CR974**



### PULL GROOVER

Cuts grooves for heat welding  
**Item #WO13424**



### RUBBER GROOVER

Cuts grooves for heat welding  
**Item #WO13842**  
Blade **Item #WO13843**



### A-1 GROOVER

Cuts grooves for heat welding  
**Item #WO13426**  
Blade **Item #WO13427**



### XACTO SEAM TRIMMER

Grooving & trimming weld at cove, corners, repairs, etc.  
**Item #WO13485**  
Y 12 mm Round Blades **Item #WO13868**  
W 6 mm Round Blades **Item #WO34401**  
Z Flat Blade **Item #WO34405**



### SKIING KNIFE

**Item #CR952**  
Blades **Item #CR1966**  
5mm Spacer **Item #CR1965A**  
7mm Spacer **Item #CR1965B**



### HALF MOON KNIVES

Flat **Item #WO13451**  
Angled **Item #WO13452**  
Bent **Item #WO13453**



### WELD SEAM SLIDE

Fits flat and angled quarter moon knives  
**Item #WO13450**



### HOT TIP TOOL KIT

Includes hot tip spoon, stand, various blades  
**Item #WO72934**

### 969 & 988

Includes hot tip spoon, stand, various blades  
**Item #WO72934**

## FLOORING CUTTERS



### HEAVY DUTY PLANK CUTTER

Works with Laminate, Wood, Luxury Vinyl, Rubber Tile, and VCT  
Movable fence for diagonal and repeat cuts  
13" **Item #CR673** | Blades **Item #CR674**  
9" **Item #CR679** | Blades **Item #CR681**



### D-CUT WALL BASE CUTTER

Works with Rubber and Vinyl Wall Base  
Bevel Cuts, Outside Corners  
**Item #DCRC200**  
Blade **Item #DCRC200B**



### 12" VCT CUTTER

Comes with Roller Case  
**Item #CR001**  
Top Blade **Item #CR1001A**  
Bottom Blade **Item #CR1001B**

## VINYL HAND TOOLS

### WAX RINGS



With Flange  
Without Flange  
Extra Thick with Bolts  
Bolts (pair)  
Bolt Covers (pair)

**Item #**PA90220  
**Item #**PA90210  
**Item #**PA001119  
**Item #**PABOLT  
**Item #**PAFLUI7115



### COVE CORNERS

Silver Outside **Item #**CR270  
Silver Inside **Item #**CR271

### ROLLERS



3 Wheel hand roller  
w/ adjustable handle  
**Item #**CR333



J Roller  
**Item #**CR346



Round head  
hand roller  
**Item #**CR349



Lino Roller + carry case  
75 lb **Item #**CR075  
100 lb **Item #**CR076



### DIVIDER

Divider **Item #**CR3380  
Pen Tip **Item #**CR1380F  
Body **Item #**CR1380G  
Inking Leg **Item #**CR1380P



### SCRIBE PAPER

MS Scribe  
3' x 167' Roll Size  
Scribe or floor protection  
**Item #**MSSCRIBPAPER

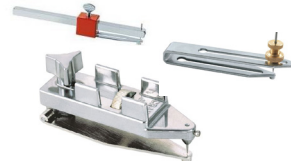

### SCRIBES

6" Bar Scribe **Item #**CR111  
Hinge Scribe **Item #**CR188  
Recess Scribe **Item #**CR370



### HEAT GUN

Up to 1000°  
Comes with case  
**Item #**CR995



### MALLETS

3 MI **Item #**PN063MIW  
5 MI **Item #**PN065MIW



### LINO-CUT

Seam cutter for sheet  
goods. Scribes & Cuts  
**Item #**WO40262  
10 Blades **Item #**WO13429



### GREEN CUT

Strip & Selvage Edge Cutter  
**Item #**WO63998  
Straight Blades 100 pack **Item #**WO13419  
Hook Blades 100 pack **Item #**WO13421



### VINYL DOLLY

36" Long  
**Item #**CR016

## FLOATING FLOOR ACCESSORIES



### TAPPING BLOCKS

3" W x 7" L **Item #**CR563  
3" W x 11 3/4" L **Item #**CR569  
2 3/8" W x 8" L **Item #**PN06TAPBLOCK  
2 3/8" W x 12" L **Item #**PN06TAPBLOCKX



**KNUCKLE HEAD  
PULL BAR**  
**Item #**CR560



**ADJUSTABLE SPACERS**  
3/16" to 13/16" Expansion Gap  
4 per box  
**Item #**GUAV2

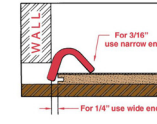

**PLASTIC SPACERS**  
3/16" or 1/4" Expansion Gap  
10 per bag  
**Item #**CR562



**MITER CUTTER**  
Angle cuts in quarter  
round and trim  
**Item #**CR855  
Blade **Item #**CR856

## PLASTIC LAMINATE INSTALLATION TOOLS



**ALL PURPOSE FILE**  
10" **Item #**GU10AP



**SCORING CUTTER**  
**Item #**MA16068



**LAMINATE SHEARS**  
**Item #**GU11LS



**MITER BOX**  
**Item #**CR176



**LAMINATE SLITTER**  
1/2" to 4 1/4" for shelf edge  
and backsplash  
**Item #**GUAT109

## WALL BASE INSTALLATION



**COVE BASE NOZZLES**  
Black 2.5" | 3 Hole **Item #**CR236  
Blue 6" | 5 Hole **Item #**CR235  
Yellow 4" | 11 Hole **Item #**GU186



**COVE BASE GOUGE**  
**Item #**CR530

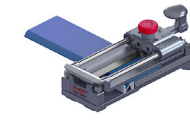

**COVE BASE GOUGE**  
**Item #**DCCB060

**SUPER GLUE**  
1 oz | For rubber and vinyl  
**Item #**CAS510Z  
Thick **Item #**CA25001

## HAND SCRAPERS & BLADES

Image	SKU	Scraper	Blade Width	Handle Length	Blade Qty	Blade SKU
	CR390	Inertial Scraper (Replacement Plates & Screws Available)	5"	18" with metal knob	10 Pack Tube 10 Pack	BE20106 CR391
	CR375	Stand Up Scraper (Replacement Plates & Screws Available)	8"	39" - 59"	10 Pack Tube 10 Pack Tube	AM610032 BE20107
	CR360	Pro Handle (Replacement Plates & Screws Available)	4"	20"	5 Pack Box 10 Pack Tube 100 Pack 10 Pack Tube 10 Pack Tube	BE80054 AM610027 AM610072 BE20103 BE20103HD
	CR350	Pro Handle (Replacement Plates & Screws Available)	4"	12"	5 Pack Box 10 Pack Tube 100 Pack 10 Pack Tube 10 Pack Tube	BE80054 AM610027 AM610072 BE20103 BE20103HD
	OR13253	Swivel T-Handle	4"	16"	5 Pack Box 10 Pack Tube 100 Pack 10 Pack Tube 10 Pack Tube	BE80054 AM610027 AM610072 BE20103 BE20103HD
	BE80194	HD Scraper	4"	18"	5 Pack Box 10 Pack Tube 100 Pack 10 Pack Tube 10 Pack Tube	BE80054 AM610027 AM610072 BE20103 BE20103HD
	GU990	Scrapper	4"	48"	5 Pack Box 10 Pack Tube 100 Pack 10 Pack Tube 10 Pack Tube	BE80054 AM610027 AM610072 BE20103 BE20103HD

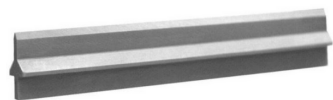

**ULTIMATE SCRAPER BLADE**

5 Pack **Item #**BE80054



**HEAVY DUTY BLADES**

10 Pack Tube **Item #**BE20103HD

## KNEE PADS



**LEATHERHEAD XL**

¾" thick foam rubber insert  
Durable leather  
**Item #**GU209XLL



**CARPET COMFORT**

Kneeling & kick protection  
No-pinch, wide velcro loops  
**Item #**CR196



**COMFORT KNEES**

Kneeling & kick protection  
No-pinch, wide velcro loops  
**Item #**CR197



**PRO 200**

Pressure distribution  
Stability while you work  
**Item #**TRTTX6420  
Inlay **Item #**: TRTTX6421  
2 Straps **Item #**: TRTTX6422  
4 Straps **Item #**: TRTTX6422



**PRO 400**

Larger pressure distribution  
Stability while you work  
**Item #**TRTTX6440  
Inlay **Item #**: TRTTX6441  
2 Straps **Item #**: TRTTX6422  
4 Straps **Item #**: TRTTX6422



**POLYURETHANE**

Prevents build up of debris  
No-pinch, wide velcro loops  
**Item #**CR199



**ACCORDION TOP**

Accordion top  
Tough & flexible cap  
**Item #**BA20010



**WASHABLE**

¾" thick foam rubber insert  
Single front fasten strap  
**Item #**GU209



**RUBBER CAP**

1/2" Thick sponge rubber  
Buckle strap  
**Item #**CR198



**LONG HARD CAP**

Protects from sharps  
Easy swivel & pivot  
**Item #**AL50403



**LONG FLEX CAP**

Mar resistant, flexible cap  
AltaLok slide-on buckle  
**Item #**AL50423



**SOFT KNEE PAD**

Mar resistant, no-cap  
For delicate surfaces  
**Item #**AL50703



**SHORT HARD CAP**

Protects from sharps  
Easy swivel & pivot  
**Item #**AL50903



**LEATHER EASY WALK**

Leather with neoprene strap  
Comfort lined  
**Item #**PH314

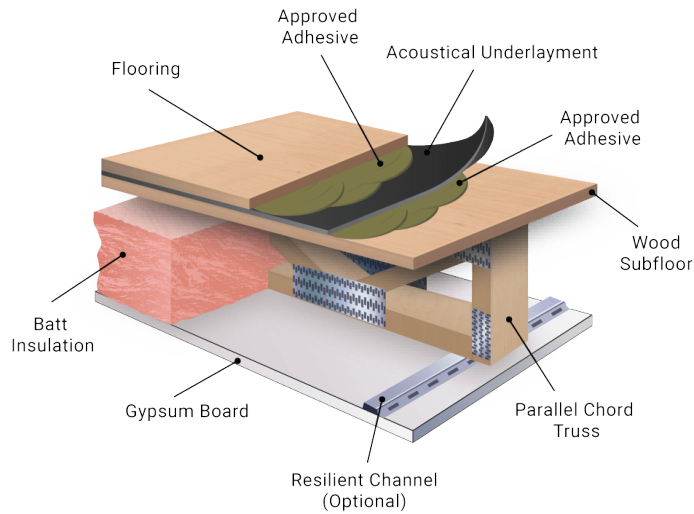

## PLYWOOD UNDERLAYMENT

## SOUND REDUCTION UNDERLAYMENT

Description & Features	SKU	Thickness	Size	Plys
<b>Powerhold Premium Hardwood Underlay</b> Printed nailing pattern	PHU21206P	¼"	4' x 5'	5
<b>MasterPly Birch Underlayment</b> Exterior grade glue, printed nail pattern, score and snap	TRMPU2216	¼"	4' x 4'	5
<b>MasterPly Birch Underlayment</b> Exterior grade glue, printed nail pattern, score and snap	TRMPU2232	¼"	4' x 8'	5
<b>Matrix Birch Underlayment</b> Printed nailing pattern	TRMXU21166P	¼"	4' x 4'	5
<b>Matrix Birch Underlayment</b> Printed nailing pattern	TRMXU21169P	¾"	4' x 4'	7
<b>Matrix Premium Hardwood Underlay</b> Printed nailing pattern	TRMXU21209P	¾"	4' x 5'	7
<b>Matrix Birch Underlay</b> Printed nailing pattern	TRMXU21329P	¾"	4' x 8'	7

### UNDERLAYMENT RICKSHANK NAILS

#TRTXN11705	1 ¼" Nail	5 lb
#TRTXN11745	1 ½" Nail	5 lb

### UNDERLAYMENT STAPLES

#TRTXF1832CGR	1" Staple	5,000/box
#TRTXF1836CGR	1 ½" Staple	5,000/box
#TRTXF1840CGR	1 ¾" Staple	5,000/box
#TRTXF1848CGR	1 ½" Staple	5,000/box

Product	Description	Laminate	Wood	Glue Down LVT	*Floating SPC / WPC	Delta IIC
Silencer LVT FOSILENCERLVT100	Polyurethane Foam 100 sf/roll	Yes	Yes	Yes	Yes	Δ 22
Eco Ultimate Silencer FOECOUSA100	SBR Foam-Cork 100 sf/roll	Yes	Yes	No	No	Δ 22
Silencer Supreme FOSILENCER100	SBR Foam 100 sf/roll	Yes	Yes	No	No	Δ 22
Eclipse II FOECLIPSEII	EVA Closed Cell Foam 100 sf/roll	Yes	Yes	Yes	No	Δ 25
3-N-1 Econo FO3N1ECONO	Polyurethane Foam IIC 61 on 6" concrete slab w/ceiling 100 sf/roll	Yes	No	No	No	N/A
Quiet Walk Fiber MPQW100B1	Synthetic Fiber 100 sf/roll	Yes	Yes	No	No	Δ 24
Genie RST 2 mm GERSTO2	Dense Crumb Rubber 300 sf/roll	Yes	Yes	Yes	Yes	Δ 18
Genie RST 5 mm GERSTO5	Dense Crumb Rubber 120 sf/roll	Yes	Yes	Yes	Yes	Δ 20
Genie RST 10 mm GERSTO10	Dense Crumb Rubber 30" x 48" 10 sf/roll	Yes	Yes	Yes	Yes	Δ 21
Reverb PHREVERB200 PHREVERB200WF	Premium SBR Rubber with tire crumb 200 sf/roll	Yes	Yes	Yes	Yes	Δ 25

\*Approved flooring as described by underlayment manufacturer. Always check flooring warranty for compatibility with a sound reduction underlayment.



# JOHNSONITE BASE & TRANSITIONS

Johnsonite items are stocked in Spokane. Select items also stocked in: Richland Kalispell Great Falls, Missoula Billings

## BASE STOCKING PROGRAM

 Icicle   #08 TP   4"	 Clay   #09 TP   4"	 Cement   #121 TP   4"	 Fudge   #167 TP   4"	 Navy Blue   #18 TP   4"
 Charcoal   #20 TP   4", 6"	 Medium Grey   #28 TP   4" & TV   2.5"	 Toast   #283 TP   4"	 Moon Rock   #29 TP   4", 6"	 Zephyr   #31 TP   4"
 Pebble   #38 TP   4"	 Almond   #34 TP   4"	 Pewter   #38 TP   4"	 Black   #40 TP   2.5", 4", 6"	 Dark Brown   #47 TP   4"
 Sandalwood   #45 TP   4"	 Brown   #47 TP   2.5", 4", 6"	 Grey   #48 TP   4", 6"	 Beige   #49 TP   2.5", 4"	 White   #50 TP   2.5", 4"
 Silver Grey   #55 TP   4"	 Burnt Umber   #63 TP   4", 6"	 Storm Cloud   #71 TP   4"	 Cinnamon   #76 TP   4"	 Fawn   #80 TP   4"

## ACCESSORIES STOCKING PROGRAM

Learn more at [commercial.tarkett.com](http://commercial.tarkett.com)

### Edge Guard

1/4" Carpet to 0  
Color #20, #40, #47, #48, #49, #63, #80  
3/8" Carpet to 0  
Color #40

### Wheeled Traffic Reducer

1/2" - 0  
Color #40, #47, #48  
1/4" - 1/8"  
Color #40

### Nosings

1/4" Undercut Carpet  
Color #40, #47  
1/8" Undercut Resilient  
Color #40  
1/4" Double Undercut  
Color #40

### Reducers

Butt to Carpet 3/8"  
Color #40  
Reducer Strip 1/8" x 3"  
Color #40  
Underslung Reducer  
Color #20, #40, #47, #48, #49, #63

### Snap Down

1/2" - 1/8"  
Color #40, #47  
1/2" - 3/8" or 1/4"  
Color #40, #47, #48, #49  
1/2" or 5/16"  
Color #40, #47, #48, #49  
1/4" or 1/8"  
Color #40, #47, #48, #49, #63

### 4' Subfloor Leveler

1/2" - 0  
1/4" - 0  
3/8" - 0

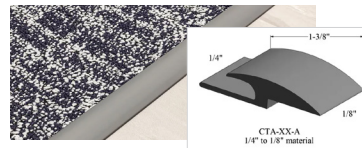

### Carpet to Vinyl Adapters

1/4" Carpet to 1/8" Vinyl  
Color #20, #40, #47, #48, #49, #63  
1/4" Carpet to 1/8" Vinyl - JR  
Color #40, #63  
3/8" Carpet to 1/8" Vinyl  
Color #40

# ROPPE BASE & TRANSITIONS

Kent stocking program listed below. Select Roppe items are also stocked in: Everett Bellevue Tacoma, Portland Eugene Bend, Medford Anchorage Hawaii

 TOP COLOR Black   #100 TPR: 6", 4.5", 4", 4" NT, 2.5" SBR: 6", 4.5", 4", 2.5" Transitions: Groups 1-4	 TOP COLOR Charcoal   #123 TPR: 4.5", 4", 4" NT, 6" SBR: 4.5", 4" Transitions: Groups 1-3	 Brown   #110 TPR: 4" SBR: 4" Transitions: Groups: 1 & 2	 Lunar Dust   #114 TPR: 4"	 Natural   #122 TPR: 4"	 Dolphin   #129 TPR: 4"	 Deep Navy   #139 TPR: 4" SBR: 4"
 Fawn   #140 TPR: 6", 4", 2.5" SBR: 6", 4.5", 4" Transitions: Groups 1 & 2	 Light Brown   #147 TPR: 4" SBR: 4"	 Dark Gray   #150 TPR: 4.5", 4", 6" SBR: 6", 4.5", 4" Transitions: Group 1	 White   #170 TPR: 6", 4", 2.5" SBR: 4", 2.5" Countours #00	 Smoke   #174 TPR: 4.5", 4" SBR: 4" Transitions: Group 1	 Slate   #175 TPR: 4" SBR: 4" Transitions: Groups: 1 & 2	 Pewter   #178 Transitions: Group 1
 Blue   #187 TPR: 4"	 Camel   #191 TPR: 6", 4.5", 4", 2.5" SBR: 4", 2.5" Transitions: Group 1	 Black Brown   #193 TPR: 6", 4.5", 4", 4" NT SBR: 6", 4.5", 4" Transitions: Groups 1 & 2	 Burnt Umber   #194 TPR: 6", 4" SBR: 4" Transitions: Group 1	 Flax   #632 TPR: 4"	 Beigewood   #639 TPR: 4"	 Galactic   #667 TPR: 4"
 Ashen   #672 TPR: 4"	 Greige   #673 TPR: 4" SBR: 4"	 Clove   #674 TPR: 4"	 Caribou   #676 TPR: 4"	 Sepia   #679 TPR: 4"	 Latte   #680 TPR: 4"	 Buff   #681 TPR: 4"
			 Calla Lily   #695 TPR: 4", 2.5"			

### VINYL ACCESSORIES

Group 1 Profiles: #169, #177, #154  
Group 2 Profiles: #152, #175, #159, #168, #172  
Group 3 Profiles: #203, #204, #206  
Group 4 Profiles: #156, #158, #160, #174, #176, #179, #196

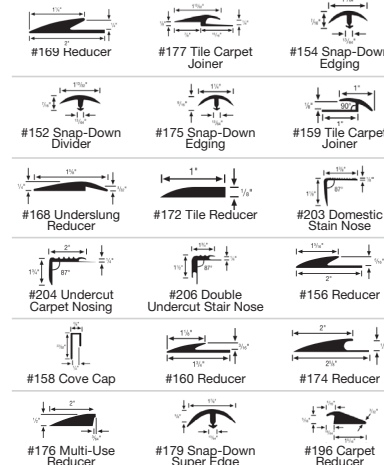

### 700 SERIES TPR

700 Series is a Thermoplastic Rubber (TPR) Wall Base. Composed of a resilient rubber-vinyl blend, 700 Series provides good flexibility while maintaining dimensional stability. Formulated with Bioplasticizer and no post-consumer recycled content is used.

### PINNACLE SBR

No matter what the project, 100% PVC free Roppe Pinnacle rubber base is ideal for the job. Pinnacle is the professional's choice, because this SBR rubber base is highly durable and extremely flexible, allowing for easy installation around columns, corners and architectural curves.

### CONTOURS

Simplicity 8' | Profile #00 | Stocked in White  
Contours Profiled Wall Base System® offers the look of wood base with the enhanced properties of resilient base. Contours resists chipping, absorbing moisture and splintering while eliminating the costly tasks of nailing, filling and finishing traditional wood trim.

## PLASTIC LAMINATE TRIMS

Profile	Description	Item #	Color
TM 19	½" Plain Facing   12' Length	FUTM19BA FUTM19BN	Buff Silver Buff Nickel
TM 80 MFA	⅛" Cap w/Flange   12' Length	FUTM80MFA	Anodized Silver
TM 80 MFA	⅛" Flat Back Cap   12' Length	FUTM81MFA	Anodized Silver
TM 82 MFA	⅜" Wide Face Cap   12' Length	FUTM82MFA	Anodized Silver
TM 90 MFA	⅛" Cove   12' Length	FUTM90MFA	Anodized Silver
TM 91 MFA	⅛" Cap   12' Length	FUTM91MFA	Anodized Silver
TM 92 MFA	⅛" Cove   12' Length	FUTM92MFA	Anodized Silver
TM 93 BA	⅛" Outside Corner   12' Length	FUTM93BA	Buff Silver
TM 94 BA	⅛" Divider   12' Length	FUTM94BA	Buff Silver

## TREADSAFE

### SAFETY STAIR TREADS

All 12' lengths, silver brushed aluminum  
Countersunk pre-drilled holes  
Inserts sold separately

### INSERTS

Stocked in 13 mm and 43 mm widths, color Neutral Black

Profile	Description	Dimensions	Item #
AA121	1 ½" Bullnose	2 ⅞" W x 1 ½" H 43 mm insert	FU402140
AA346	1 ¾" Right Angle Drop	2 ½" W x 1 ⅜" H 3 x 13 mm inserts	FU402128
AA345	1 ¾" Bullnose	3" W x 1 ⅜" H 3 x 13 mm inserts	FU402143

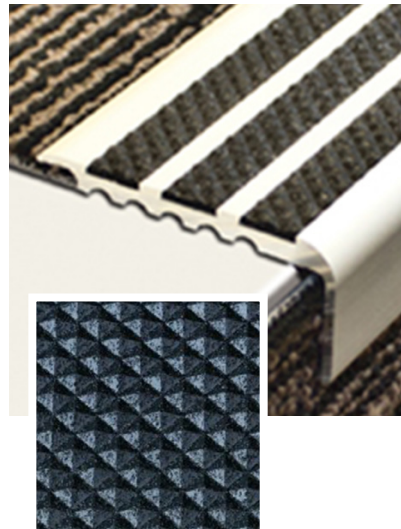

## METAL CARPET TRANSITIONS

Nails sold separately for some transitions and finishes

Profile	Grade	Color	SKU
Pinless Clampdown	Premium	Silver Brass Nickel	FUCM201HMF FUCM201HB FUCM201HN
Stairnose	Standard	Silver Brass Nickel Bronze	FUCM611HMF FUCM611HB FUCM611HN FUCM611HBRZ
Stairnose	Premium	Silver Brass	FUCM601HMF FUCM601HB
Stairnose	Longface Premium	Silver Nickel	FUCM605HMF FUCM605HN
Stairnose	2.6" Commercial Premium	Etched Aluminum	FUCM603EA
Pinned Clamp Down	Premium	Silver Brass Nickel	FUCM102HMF FUCM102HB FUCM102HN
Pinned Clamp Down	Standard	Silver Brass Bronze Nickel	FUCM104HMF FUCM104HB FUCM104HBRZ FUCM104HN
Pinned Clamp Down	Economy	Silver Gold	FUCM122114HMF FUCM122117HB
Flat bar	2" HD Premium	Silver Brass Nickel	FUCM304HMF FUCM304HB FUCM304HN
Flat bar	1.5" HD Premium	Silver Brass Nickel	FUCM302HMF FUCM302HB FUCM302HN
Flat Bar	1.5" Standard	Silver Bronze Nickel Brass	FUCM312HMF FUCM312HBRZ FUCM312HN FUCM312HB
Flat Bar	1" HD Premium	Silver Brass Nickel	FUCM303HMF FUCM303HB FUCM303HN
Flat Bar	1" Standard	Silver Bronze Nickel Brass	FUCM313HMF FUCM313HBRZ FUCM313HN FUCM313HB

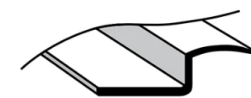
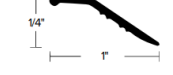
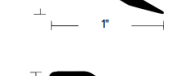
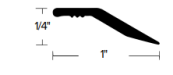
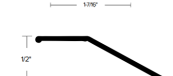
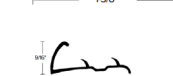
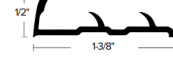
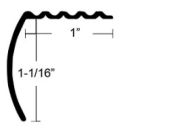

### Z-BAR

4' | 25/ctn FUCM501MF4

### TACKSTRIP CLAMP

Silver FUCM121HMF

### BINDER BAR

Silver FUCM702HMF

### ¼" CARPET CAP

Hammered Silver FUCM401HMF  
Anodized Silver FUCM401MFA

### HATCH-TEE

1" Silver FU7395BA  
¾" Silver FU7365BA



Silver (HMF)



Brass (HB)

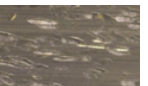

Nickel (HN)



Bronze (HBRZ)



Etched Al. (EA)

# LVP-LVT TRANSITIONS

Profile	Size	Color	SKU
	#630   3 mm	Nickel Bronze	FULVT630EN FULVT630BRZ
	#606   4 mm	Silver Nickel	FULVT606EA FULVT606EN
		Silver Nickel	FULVT608EA FULVT608EN
	#604   6 mm	Nickel	FULVT604EN
	#612   7 mm	Nickel	FULVT612EN
Reducer	#160   5mm	Silver Nickel	FULVT160EA FULVT160EN
Carpet to LVT	#130   3 mm	Silver Nickel	FULVT130EA FULVT130EN
	#150   5 mm	Silver Nickel	FULVT150EA FULVT150EN
Ramp Edge	#123   2.5-3.5 mm	Mill Finish	FULVT123MF
	#124   2.5-4.5 mm		FULVT124MF
	#125   3.0-4.5 mm		FULVT125MF
	#127   3.5-5.0 mm		FULVT127MF
Joiner	#128   2.5-3.0 mm	Mill Finish	FULVT128MF
	#102   2.5 mm	Nickel	FULVT102EN
Bevel Cap	#406   3 mm	Silver	FULVT406EA
Square Cap	#925   2.5 mm	Nickel	FULVT925EN
	#904   4 mm	Nickel Bronze	FULVT904EN FULVT904BRZ
	#905   5 mm	Silver Nickel	FULVT905EA FULVT905EN
	#907   7 mm	Nickel	FULVT907EN
	#908   8 mm	Nickel	FULVT908EN
Stair Edge	#340   3 mm	Nickel Bronze	FULVT340EN FULVT340BRZ
	#341   5 mm	Silver Nickel	FULVT341EA FULVT341EN

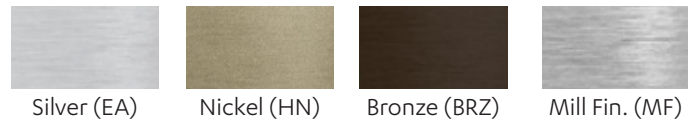

## NOW STOCKING Metal Profiles | Shower Systems | Ditra

- ✓  
TRUSTED DISTRIBUTION  
& LOGISTICS
- ✓  
LOCALLY STOCKED
- ✓  
CONVENIENT ONLINE  
ORDERING



View the complete stocking program



# SCHLUTER PROFILES

Kent stocking profiles listed below, available in assorted dimensions and colors. Limited stocking programs available at all T&A Supply branches.

TRANSITIONS



## JOLLY

Schluter®-JOLLY features a 90° angle and is a finishing and edge-protection profile for the outside corners and other tile edges in wall applications. The vertical wall section of the profile provides a decorative finish and protects adjacent tiles. Its 90° angle creates a clean, flush look on wall corner installations, and the joint spacers on both sides of the profile ensure consistent grout joints and perfect symmetry.

### Stocked Colors:

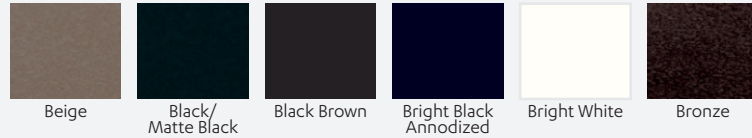

## DECO

Schluter®-DECO is designed to provide decorative lines within tile coverings and edge protection at transitions from tile coverings to other same-height surface coverings, such as wood or carpet.

### Stocked Color:



## DILEX

Schluter®-DILEX-AHK is a cove-shaped profile with a single anchoring leg that provides an attractive, clean, and maintenance-free alternative for inside wall corners, and countertop/backsplash and floor/wall transitions.

### Stocked Colors:

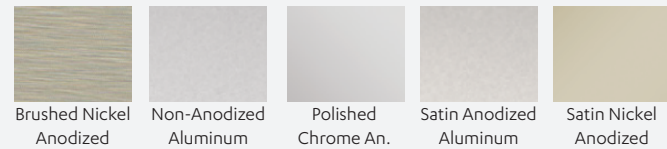

## RENO U & RENO TK

Schluter®-RENO is designed to protect tile edges and provide a smooth transition between tile coverings and floor coverings at lower elevations by abutting both surfaces.

### Stocked Colors:

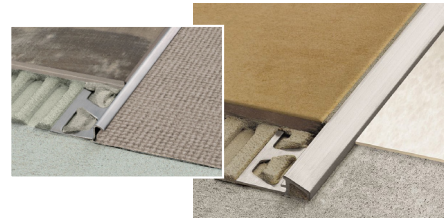
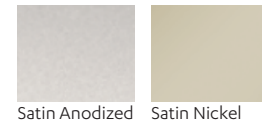

## SCHIENE

Schluter®-SCHIENE is an edging profile featuring an 87° angle designed to provide effective and attractive edge protection for floor tile coverings that are typically bordered by carpet, at expansion joints, or as decorative edging for stairs. The profile offers a discreet, minimum reveal which is ideal for creating elegant transitions between floor coverings.

### Stocked Colors:

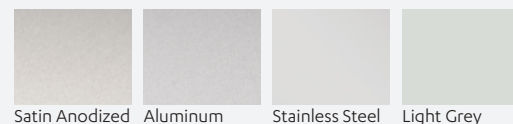

# SCHLUTER PROFILES

## Jolly Stocked Colors Continued:



## RONDEC

Schluter®-RONDEC is a finishing and edge-protection profile for tiled edges and outside corners of tiled surfaces. The reveal of the profile forms a symmetrically rounded corner along the surface edge.

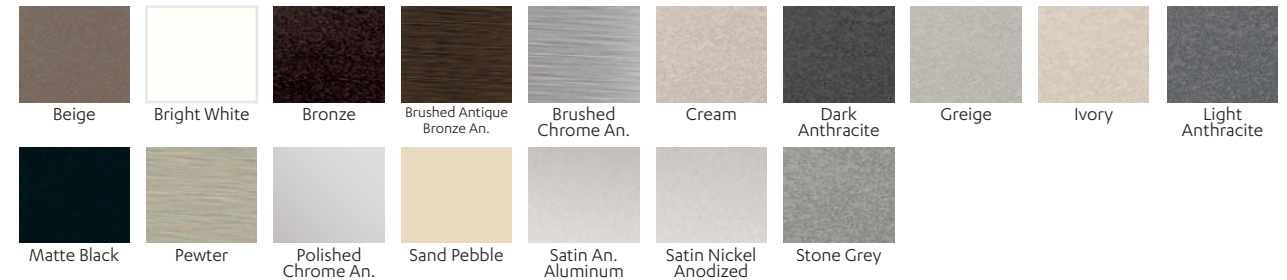

## QUADEC

Schluter®-DILEX-AHK is a cove-shaped profile with a single anchoring leg that provides an attractive, clean, and maintenance-free alternative for inside wall corners, and countertop/backsplash and floor/wall transitions.

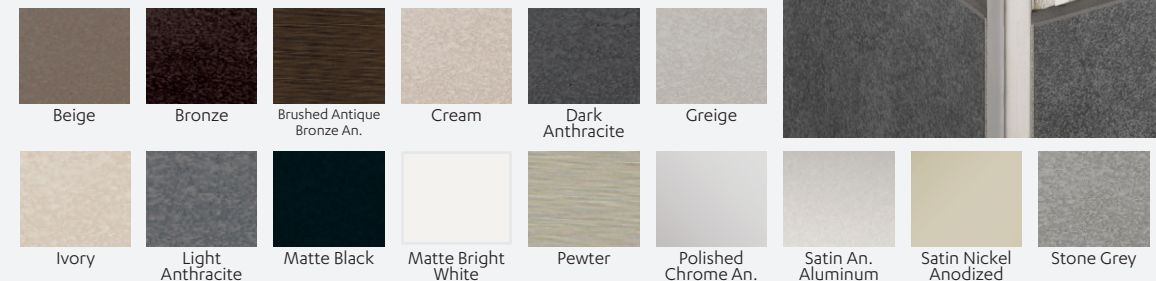

TRANSITIONS

## MORTAR & THINSET



**209 FLOOR MUD**  
# LA209TBED  
**SIZE** 60 lb  
**COLOR** Grey  
**ANSI STANDARD** N/A  
**APPLICATION** Interior Floors  
Traditional Mortar Bed



**317 MORTAR UNMODIFIED**  
#LA31750GRY  
# LA31750WHT  
**SIZE** 50 lb  
**COLOR** Grey  
White  
**ANSI STANDARD** N/A  
**APPLICATION** Interior & Exterior  
Floor & Wall



**252 SILVER**  
# LA25250GRY  
# LA25250WHT  
**SIZE** 50 lb  
**COLOR** Grey  
White  
**ANSI STANDARD** A118.4  
**APPLICATION** Large Tile Floor & Wall  
Interior & Exterior



**253 GOLD**  
# LA25350GRY  
# LA25350WHT  
**SIZE** 50 lb  
**COLOR** Grey  
White  
**ANSI STANDARD** A118.15  
**APPLICATION** Large Tile Floor & Wall  
Interior & Exterior



**253 GOLD RAPID**  
# LA253R50GRY  
# LA253R50WHT  
**SIZE** 50 lb  
**COLOR** Grey  
White  
**ANSI STANDARD** ANSI A118.4F  
**APPLICATION** Large Tile Floor & Wall  
Interior & Exterior



**GLASS TILE ADHESIVE**  
# LA296012522  
**SIZE** 12.5 lb  
**COLOR** White  
**ANSI STANDARD** A118.4  
**APPLICATION** Mosaic Glass Tile Floor & Wall  
Interior & Exterior Submersible



**LHT PLUS**  
# LALHTPLUS50GRY  
# LALHTPLUS50WHT  
**SIZE** 50 lb  
**COLOR** Grey  
White  
**ANSI STANDARD** A118.4  
A118.11  
**APPLICATION** Large & Heavy Tile Floor & Wall  
Interior & Exterior



**TRI-LITE**  
# LATRILITEG30  
# LATRILITEW30  
**SIZE** 30 lb  
**COLOR** Grey  
White  
**ANSI STANDARD** A118.15 HET  
A118.4  
A118.11  
**APPLICATION** Large & Heavy Tile Light Weight  
Interior & Exterior Floor & Wall



**4-XLT**  
# LA24XLT50GRY  
# LA24XLT50WHT  
**SIZE** 50 lb  
**COLOR** Grey  
White  
**ANSI STANDARD** A118.15, A118.4, A118.11  
Exceeds ISO 13007-C2TES1P1  
**APPLICATION** Large & Heavy Tile  
Interior & Exterior  
Floor & Wall

## MORTAR & THINSET



**254 PLATINUM**  
# LA25450GRY  
# LA25450WHT  
**SIZE** 50 lb  
**COLOR** Grey  
White  
**ANSI STANDARD** A118.15, A118.4,  
A118.11  
Exceeds ISO  
13007-C2TES1P1  
**APPLICATION** Large Tile  
Interior & Exterior  
Floor Only



**MULTIMAX (289)**  
# LA28925GRY  
# LA28925WHT  
**SIZE** 25 lb  
**COLOR** Grey  
White  
**ANSI STANDARD** A118.15 HET  
A118.4, A118.11  
Exceeds ISO  
13007-C2TES1P1  
**APPLICATION** Large & Heavy Tile Light Weight  
Interior & Exterior Floor & Wall  
Submersible



**VERSABOND**  
# CUMTSG50  
# CUMTSW50  
**SIZE** 50 lb  
**COLOR** Grey  
White  
**ANSI STANDARD** A118.4H  
A118.11  
**APPLICATION** Large Tile Floor & Wall  
Interior & Exterior



**CX 20 3-N-1**  
# UZCX2040G  
# UZCX2040W  
**SIZE** 40 lb  
**COLOR** Grey  
White  
**ANSI STANDARD** A118.4  
A118.11  
**APPLICATION** Interior Only  
Floor & Wall  
Large Tile



**CX 30 3-N-1**  
# UZCX3040G  
# UZCX3040W  
**SIZE** 40 lb  
**COLOR** Grey  
White  
**ANSI STANDARD** A118.4  
A118.11  
ISO C2TE-S1  
**APPLICATION** Interior & Exterior Large Tile  
Floor & Wall Submersible



**CX 33 BI TURBO**  
# UZCX3327G  
# UZCX3327W  
**SIZE** 27.5 lb  
**COLOR** Grey  
White  
**ANSI STANDARD** N/A  
**APPLICATION** Interior & Exterior  
Floor & Wall  
Large Tile



**ALL SET**  
# SCSETA50G  
# SCSETA50W  
**SIZE** 50 lb  
**COLOR** Grey  
White  
**ANSI STANDARD** A118.4  
A118.15  
A118.11  
**APPLICATION** Interior & Exterior  
Floor & Wall  
Large & Heavy Tile

## NEED MORE PRODUCT INFORMATION?

YOU HAVE OPTIONS!

Go to [www.dealerportal.tasupply.com](http://www.dealerportal.tasupply.com) to view item info, check inventory, and pricing.  
Visit the vendors' websites for technical data and install sheets.

# GROUT, SILICONE, CAULK

See Grout Floats on page 48



PC

## PERMACOLOR

Color Consistent, Pre-colored Grout  
Enhanced Strength & Stain Resistance  
Stocked in about 30 colors  
8lb Bag **Item #LAPG08\_**  
25lb Bag **Item #LAPG25\_**



## PERMACOLOR SELECT

2-part Cementitious Compound  
Uses Permacolor Color Kits  
10 or 20lb Sanded Base **Item #LAPCSBASE\_**  
8lb Non Sanded Base **Item #LAPSBASENS8**



## PERMACOLOR COLOR KITS

Dispersible Dry Pigment  
Mixes with Permacolor Select  
Stocked in 40 colors  
**Item #LAPCS\_**



SL 1

## SPECTRALOCK 1

Performance of Epoxy Grout in a  
Pre-Colored System  
**Item #LASL1\_**



## SPECTRALOCK PRO

High Performance & Color Consistency  
2 Part Epoxy Grout  
Uses Spectralock Part C Color Bags  
**Commercial Item #LASLPPCOMM**  
**Full Item #LASLPPFULL**  
**Mini Item #LASLPPMINI**



## SPECTRALOCK 2000 IG

Industrial Grade, Chemical Resistant  
Epoxy Grout  
Uses 4 Spectralock Color Kits/Unit  
**Item #LASLOCK2000IG4**



SL

## SPECTRALOCK COLOR KITS

Dispersible Dry Pigment  
Mixes with Spectralock Products  
Stocked in about colors  
Spectralock **Item #LASLOCK12\_**



S

C

## SILICONE & CAULK

Latasil 100% Silicone  
Interior Siliconized Sanded Caulk  
Stocked in 40 colors  
Silicone **Item #LASILIC62\_**  
Sanded Caulk **Item #LAS03\_**

# STOCK COLORS

 #03 SILK	 #09 FROSTY	 #17 MARBLE BEIGE	 #22 MIDNIGHT BLACK	 #23 ANTIQUE WHITE	 #24 NATURAL GRAY
 #27 HEMP	 #30 SAND BEIGE	 #34 SANDSTONE	 #35 MOCHA	 #39 MUSHROOM	 #40 LATTE
 #42 PLATINUM	 #44 BRIGHT WHITE	 #45 RAVEN	 #46 QUARRY RED	 #52 TOASTED ALMOND	 #53 TWILIGHT BLUE
 #56 DESERT KHAKI	 #57 HOT COCOA	 #58 TERRA COTTA	 #59 ESPRESSO	 #60 DUSTY GREY	 #61 PARCHMENT
 #66 CHESTNUT BROWN	 #67 AUTUMN GREEN	 #78 STERLING SILVER	 #81 BUTTER CREAM	 #85 ALMOND	 #87 STORMY GREY
 #88 SILVER SHADOW	 #89 SMOKE GREY	 #90 LIGHT PEWTER	 #91 SLATE GREY	 #93 FOSSIL	 #94 WALNUT
 #95 MINK	 #96 STEAMSHIP	 #97 IRON			

## DE-HAZE AND CLEANERS



### KLENZALL

Cleans, de-greases, and prepares surface for resealing  
1 Qt **Item #**ST319063220



### DEEPKLENZ

Removes stubborn dirt, grease, grime, oil, and food stains from stone, tile, and grout  
24 oz **Item #**ST439062410



### GROUT RELEASE

Pre-apply to stone surfaces to easily remove grout residue  
1 Gal **Item #**ST3050401



### EPOXY GROUT HAZE & COATING STRIPPER

Gel removes haze from epoxy grouts and tough coatings on horizontal or vertical surfaces  
1 Qt **Item #**ST316063211  
1 Gal **Item #**ST316040111

## SEALERS



### BULLETPROOF SEALER

Water-based sealant with Microban® technology provides maximum stain resistance

1 Pt **Item #**ST3021216  
1 Qt **Item #**ST3020632  
1 Gal **Item #**ST3020401



### HEAVY DUTY SEALER

Water-based penetrating sealer provides stain resistance while preserving natural appearance

1 Pt **Item #**ST3091216  
1 Qt **Item #**ST3090632  
1 Gal **Item #**ST3090401



### QUARTZ & PORCELAIN SEALER

Water-based sealant with Microban® technology provides maximum stain resistance to quarts and engineered stone & tile

1 Qt **Item #**ST3140632



### ENHANCER PRO

Solvent based, color enhancing, penetrating sealer for stone, masonry and grout

1 Qt **Item #**ST3020632



### IMPREGNATOR PRO

Solvent based, penetrating sealer for stain protection on stone, masonry, and grout

1 Qt **Item #**ST3170632  
1 Gal **Item #**ST3170401



### REVITALIZER CLEAN & SEAL

Clean, reseal, and defend against bacteria, mold, and mildew

24 oz **Item #**ST328062411



### SPRAY-ON SEALER

Solvent based spray-on sealer for vertical or horizontal surfaces

15 oz **Item #**GUGS02

## WATERPROOFING

 See Shower Systems Page 48 for Crack Isolation & Anti-Fracture

### HYDRO BAN

Single component self-curing liquid rubber polymer that forms a flexible, seamless waterproofing membrane.

Flood testing after 2 hours

1 Gal **Item #**LAHYDROBAN1  
5 Gal **Item #**LAHYDROBANS



### HYDRO BAN XP

Waterproofing and crack protection for interior and exterior spaces including steam rooms and submerged applications.

Flood testing after 2 hours

1 Gal **Item #**LAHYDROBANXP1  
5 Gal **Item #**LAHYDROBANXP5



### HYDRO BARRIER PLUS

Seamless waterproofing membrane + crack isolation membrane. Interior and exterior. Horizontal or vertical surfaces.

Flood testing after 12 hours

1 Gal **Item #**LABARRIERPLUS1  
3.5 Gal **Item #**LABARRIERPLUS3



### HYDRO BAN QUICK CURE

Waterproofing membrane for humid, cold, and damp environments.

Flood testing after 30 minutes

1 Gal **Item #**LA926600012



### RED GARD

Waterproof membrane and crack isolation for interior and exterior applications.

Flood testing after dry

1 Gal **Item #**LABARRIERPLUS1  
3.5 Gal **Item #**LABARRIERPLUS3



### HS 100

Acrylic polymer based waterproofing membrane for interior and exterior applications.

Flood testing after 4 hours

1 Gal **Item #**UZ83741  
2.5 Gal **Item #**UZ82101



### HS 200

Flexible one-component, cement-based waterproofing membrane and crack isolation for interior, exterior, and immersion applications.

27.5 lb **Item #**UZ81088

### HYDRO BAN CEMENTITIOUS MEMBRANE

One component, polymer fortified, cement based waterproofing material that mixes with water.

Flood testing after 2 hours

30lb bag **Item #**LAHBCEMENT30





## CERAMIC HAND TOOLS



**HYDRO SPONGE**  
Item #RUSPXL



**T-7 TILE SPONGE**  
Item #PAAXT7



**MICROFIBER SPONGE**  
Item #RUSPBLOCKMF



**XL EPOXY SPONGE**  
Item #RUSPEPOXY



**HANDLE & SCRUBBER**  
Handle Item #RUSPSPH  
Pad Item #RUSPSPW



**EPOXY GROUT FLOAT**  
Lightweight and wear resistant  
4" x 10 1/2" Pad  
Item #BA81300



**GROUT FLOAT**  
URethane bottom  
3 1/2" x 9 1/2" pad  
Item #GU55RU



**GROUT KIT**  
Cut grout time by 30%  
Includes bucket, 2 handles, sponges, and scrub pads  
Item #BA81584



**CARBIDE SCORING**  
Item #MA16068



**GROUT MIXER**  
Item #RUMXDBM



**BUCKET HEATER**  
Heats one gallon from 60° to 130°  
in 10 minutes  
Item #GU742G

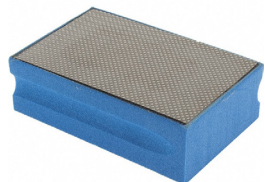

**DIAMOND POLISHING PAD**  
60 Grit Item #GUDT060  
200 Grit Item #GUDT200



**MARGIN TROWEL**  
2" x 6" Item #BA70911  
2" x 8" Item #BA70912

## MEMBRANES

## CRACK ISOLATION & ANTI-FRACTURE

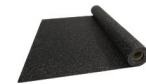

**GENIE MAT**  
GERST05

**SIZE**  
5 mm  
4' x 30'

**COVERAGE**  
120 sf/roll

**FEATURES**  
Acoustic underlayment which can be used under tile and other hard surface



**STRATA MAT**  
UNCOUPLING MEMBRANE

**SIZE**  
45" x 40'  
45" x 86'  
45" x 40'

**COVERAGE**  
150 sf/roll  
323 sf/roll  
150 sf/roll

**FEATURES**  
Eliminates crack transmission up to 1/8"  
XT also provides vapor protection



**FRACTURE BAN**  
ANTI-FRACTURE MEMBRANE

**SIZE**  
39.25" x 69'  
1 Gallon

**COVERAGE**  
225 sf/roll  
285 sf/gal

**FEATURES**  
Peel & Stick crack membrane, prevents in-plane cracks up to 3/8"



**FRACTURE BAN SC**  
ANTI-FRACTURE LIQUID

**SIZE**  
3.5 Gallon

**COVERAGE**  
175 SF/gal

**FEATURES**  
Prevents in plane cracks up to 1/8"  
Roll on application, color dry indicator